



**HAL**  
open science

# Cure Monitoring and SHM of Carbon Fiber Reinforced Polymer Part I: Impedance Analysis and Multiphysic Sensitivity

Mahamadou Moukaila, Thierry Camps, Philippe Marguerès, Philippe Olivier, Christophe Escriba, Jean-Yves Fourniols

► **To cite this version:**

Mahamadou Moukaila, Thierry Camps, Philippe Marguerès, Philippe Olivier, Christophe Escriba, et al.. Cure Monitoring and SHM of Carbon Fiber Reinforced Polymer Part I: Impedance Analysis and Multiphysic Sensitivity. *e-Journal of Nondestructive Testing*, 2015, 20 (2), pp.560-566. hal-04492855

**HAL Id: hal-04492855**

**<https://hal.science/hal-04492855v1>**

Submitted on 7 Mar 2024

**HAL** is a multi-disciplinary open access archive for the deposit and dissemination of scientific research documents, whether they are published or not. The documents may come from teaching and research institutions in France or abroad, or from public or private research centers.

L'archive ouverte pluridisciplinaire **HAL**, est destinée au dépôt et à la diffusion de documents scientifiques de niveau recherche, publiés ou non, émanant des établissements d'enseignement et de recherche français ou étrangers, des laboratoires publics ou privés.

## CURE MONITORING AND SHM OF CARBON FIBER REINFORCED POLYMER PART I : IMPEDANCE ANALYSIS AND MULTIPHYSIC SENSITIVITY

M. Mounkaila<sup>1,2</sup>, T. Camps<sup>1,2</sup>, S. Sassi<sup>1</sup>, Ph. Marguerès<sup>1</sup>, Ph. Olivier<sup>1</sup>, C. Escriba<sup>1,2</sup>,  
J.Y. Fourniols<sup>1,2</sup>

<sup>1</sup> Université de Toulouse ; INSA, UPS ; ICA (Institut Clément Ader) F-31077 Toulouse

<sup>2</sup> CNRS, LAAS F-31077 Toulouse

mounkaila@laas.fr  
camps@laas.fr

### ABSTRACT

The high-performance composite materials based on carbon fiber are increasingly used in critical security areas (aeronautics, civil engineering). Thus, it is important to know their characteristics during curing process or their use. We present herein a technique of electrical impedance analysis to extract some specific material properties (resistance and capacitance) in order to know its behavior. As the material microstructure contains a conductor part (carbon fiber) and an insulator part (resin), a model of electrical conduction in the material was established by using a network of a resistance  $R_p$  connected in parallel with a capacitance  $C_p$  (impedance  $Z$ ). Spectroscopic impedance analysis of the studied samples informs about the intrinsic properties of material and shows a sensitivity of these electrical parameters ( $R_p$ ,  $C_p$ ) according to the curing cycle. Then the sensitivity to some physical parameters (temperature, deformations, etc.) will be demonstrated in order to know the health of the material, thus ensure Structural Health Monitoring (SHM).

**KEYWORDS :** *electrical modelisation, impedance analysis, cure monitoring, SHM.*

### INTRODUCTION

Carbon Fiber Reinforced Polymers (CFRP) are highly used in aeronautics for high mechanical performances as regards to their low density. They offer many benefits such as mechanical strength, mass and consumption reduction. With the aim of optimizing their use, efforts are employed by using several techniques to monitor their curing cycle or the health of structures during their use.

Beyond existing methods of unique measurement of resistance [1,2] or capacitance [3,4], we present in this paper a method of impedance measurement and analysis that provides both electrical parameters (resistance and capacitance). The conductive and insulating properties of materials are studied by applying an alternating current combined with a voltage measurement using a dedicated instrumentation. Here the studied material is made from carbon T700/epoxy M21 prepregs (used in aerospace).

Firstly, a three-dimensional (3D) model of electrical conduction is considered to describe the anisotropy of the material. This model consists of a resistance and a capacitance connected in parallel ( $R_p$ ,  $C_p$ ). Then, we will describe the insertion method of thin electrodes (35  $\mu\text{m}$  thick) inside the material and the specific impedance measurement bench developed to make a real-time measurement of  $R_p$  and  $C_p$ . The sensitivity of both  $R_p$  and  $C_p$  in different stages of the curing cycle will be also studied here. All this aims to provide a cure monitoring and the possibility to real-time control to obtain the desired properties of the produced composite structures. Finally, we will

present the measurements on manufactured composite samples to demonstrate the sensitivity of  $R_p$  and  $C_p$  according to physical loads (such as deformations and temperature) in order to provide necessary elements to know or predict the material health (for SHM purpose).

## 1 MODEL USED FOR THE ELECTRICAL CONDUCTION

Prepregs are plies (256  $\mu\text{m}$  thick) made of M21 epoxy resin and high strength carbon fibers (7  $\mu\text{m}$  diameter). The fibers orientation is unidirectional (UD) inside the ply. This confers anisotropic electrical properties. As the material contains a conductor part (fibers) and an insulator part (resin), we consider a resistive conduction linked to the conduction through fibers or percolation points, and a capacitive conduction through resin or voids (see figure 1). In order to improve the representation of the different mechanisms of this electrical conduction, analyses of the conduction in the fibers plane in mono-ply samples (inside one ply: intra-ply) and multi-ply samples (inside laminates) were undertaken.

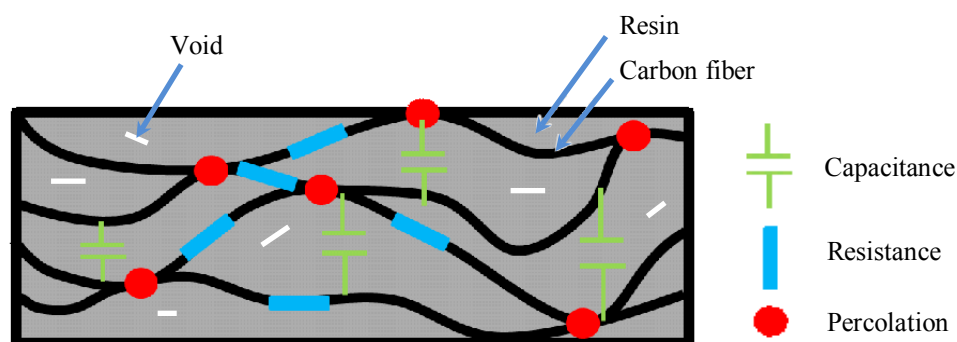

Figure 1: Equivalent electrical model in composite material

### 1.1 Intra-ply conduction analysis

In order to reduce the interface resistances and to avoid being intrusive, thin and flexible electrodes (flex) are inserted between one prepreg cured on a FR4 substrate (printed circuit board). The flex used in this case is a copper tape (50- $\mu\text{m}$  thick, 6-mm wide and 4-cm long) covered with a polyimide film (35- $\mu\text{m}$  thick) at masking areas. Several flex are placed in the longitudinal and transverse directions to the fibers orientation (see figure 2). The impedance analysis requires a frequency sweep, here from 10 Hz to 1 MHz. The resistive measurements are performed at 10 Hz and the capacitive measurements at 100 kHz.

In the longitudinal direction (intra-fibers), preliminary measurements show that changes in the resistance value depend on the distance between electrodes. This evolution is almost linear (see figure 3. a). We obtained a resistivity value around  $15 \cdot 10^{-5} \Omega \cdot \text{m}$ ; its determination is difficult because of the presence of significant contacts resistances ( $R_C$  between 1 to 4  $\Omega$ ) disrupting our measurements. These impose 4-points measurement method. Capacitances are sporadic because of the low resistances values disrupting also their measurements. In the transverse direction (inter-fibers), the measurements show high resistance values with a resistivity around 1.5  $\Omega \cdot \text{m}$  (against  $15 \cdot 10^{-5} \Omega \cdot \text{m}$  in the intra-fibers conduction); but the capacitances are more significant (see figure 3. b). In this case 2-points measurement method is used because contacts resistances effects are negligible.

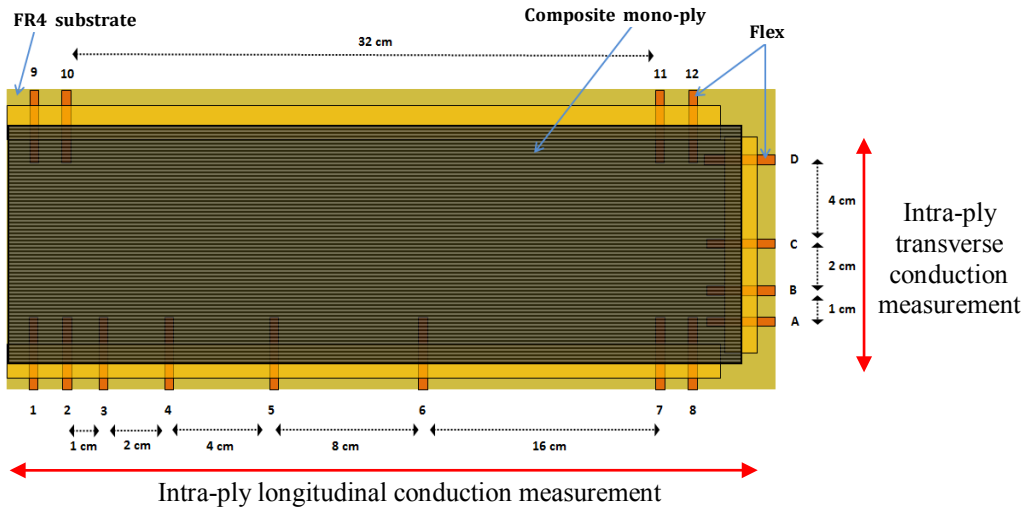

Figure 2: Intra-ply conduction test sample

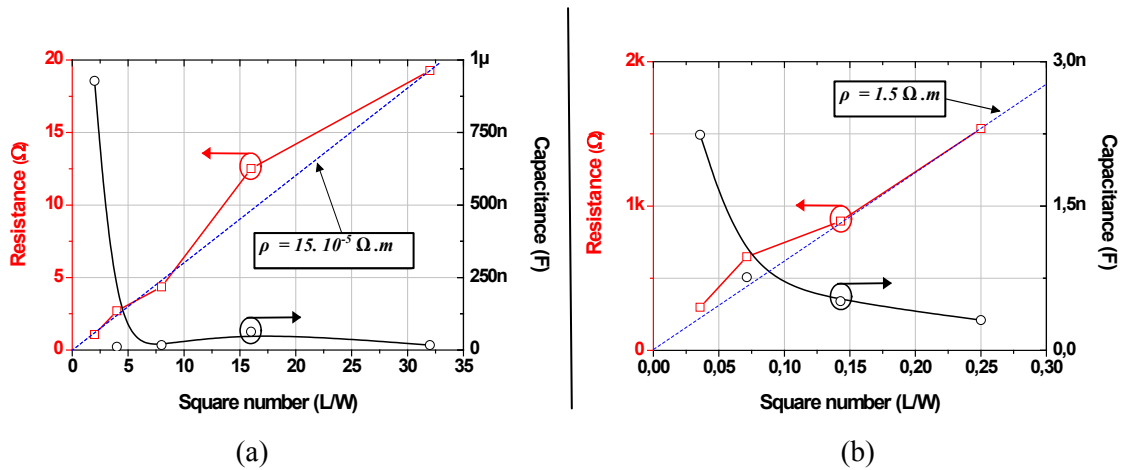

Figure 3: Changes in the resistance and capacitance versus measurement surface. intra-fibers measurement (a), inter-fibers measurement (b)

Finally, the intra-fibers electrical conduction is essentially resistive (through fibers and percolation points) and it is modeled as distributed resistances. But the inter-fibers conduction is resistive and capacitive (through percolation points, resin and voids). This later is modeled as a network of resistances in parallel with capacitances ( $R_p$ ,  $C_p$ ) as shown in the figure 4.

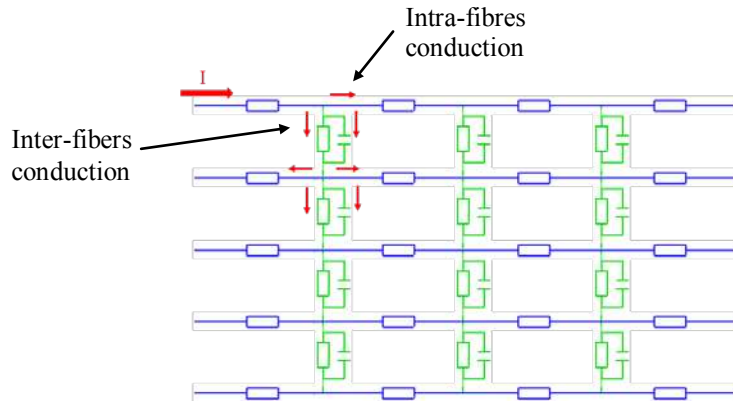
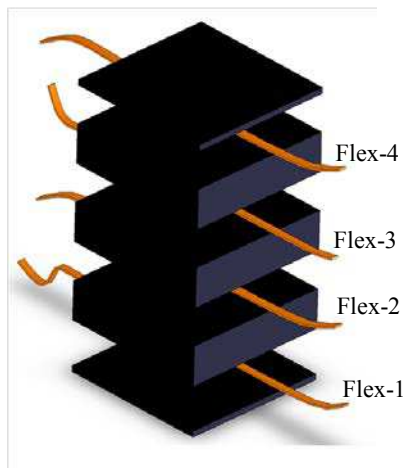

Figure 4: Intra-ply conduction modeling

### 1.2 Conduction analysis inside multi-ply composites

Multi-ply samples contain up to 24 plies ( $10 \times 10 \text{ cm}^2$ ). Before curing, some flex are inserted in the transverse direction between two consecutive plies in order to reduce the interface resistances (see figure 5. a). In fact the used flex in this case are 20 cm-long. The Flex-1 is placed between plies 1 and 2, the flex-2 between plies 8 and 9, the flex-3 between plies 16 and 17, and finally the flex-4 between plies 23 and 24. This configuration enables us to measure in the composite thickness direction (inter-ply). The changes in the resistance and capacitance values exhibit a quasi-linear behavior with the conduction in thickness (see figure 5.b). The obtained inter-ply resistivity is around  $4.5 \text{ } \Omega \cdot \text{m}$  against  $1.5 \text{ } \Omega \cdot \text{m}$  in the inter-fibers conduction and  $15 \cdot 10^{-5} \text{ } \Omega \cdot \text{m}$  in the intra-fibers conduction.



(a)

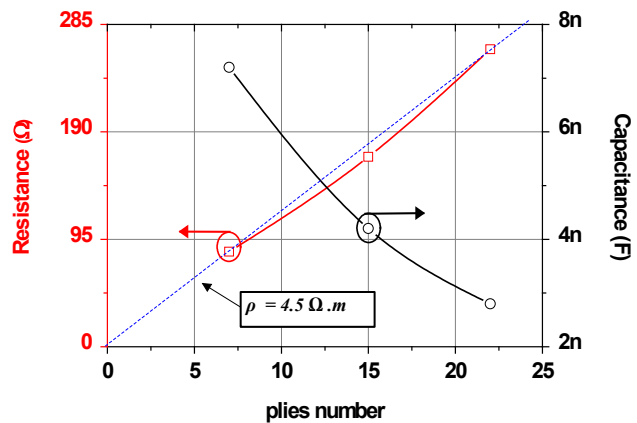

(b)

Figure 5: Inter-ply conduction test sample (a), resistance versus plies number (b)

The intra-ply conduction in the multi-ply is considered as the same as the one in the mono-ply. The inter-ply conduction is similar to the one in the transverse direction (conduction through percolation points, resin or voids). It is modeled as a resistance in parallel with a capacitance. Finally the 3D electrical model equivalent to a multi-ply composite material can be considered as a cascaded structure of hexapole nodes (see figure 6).

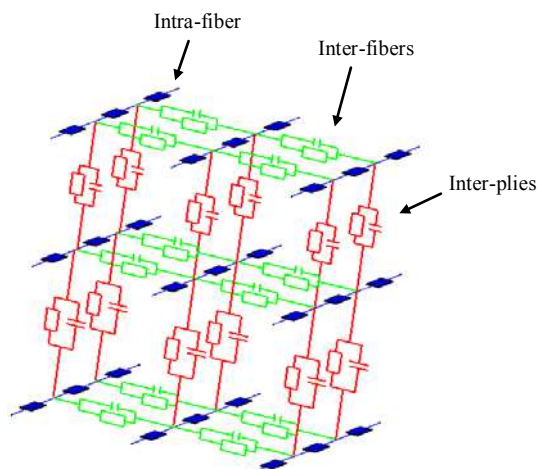

Figure 6: 3D electrical conduction model for a multi-ply composite material

## 2 CURE MONITORING

A test bench is developed here for cure monitoring of composite materials (see figure 7). It contains:

- **Impedance analyzer** :  $R_p$  (at 10 Hz) and  $C_p$  (at 100 kHz) measurement with a frequency sweep from 10 Hz to 1 MHz;
- **Channel selector** : measurement on several samples or positions;
- **Temperature measurement circuit** via a K thermocouple;
- **LabView software** : on-line monitoring of the later parameters.

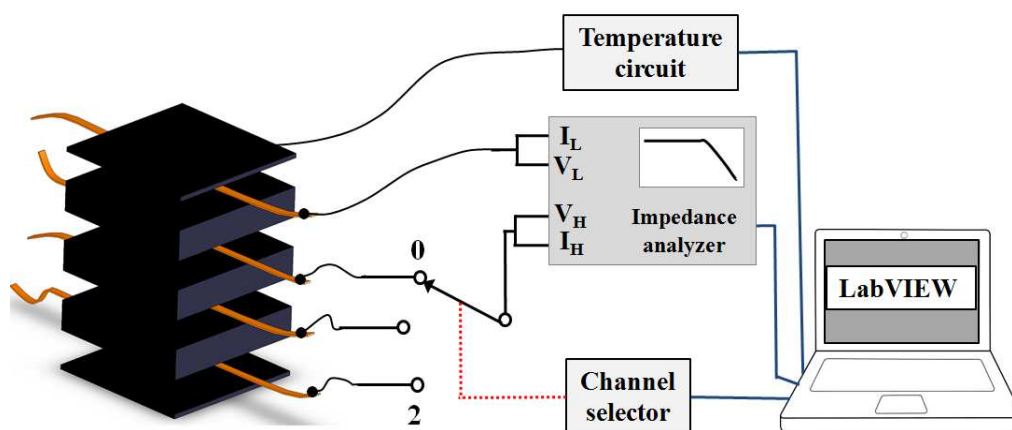

Figure 7: Measurement bench

The real-time measurements are realized during curing (in an oven) on 24 plies UD samples to characterize the inter-ply conduction. The measurement is made between flex 1 and 4 (22 plies). Figure 8 shows the results of  $R_p$  and  $C_p$  obtained during curing. As could have been expected,  $R_p$  decreases versus time from 30 k $\Omega$  to few hundred ohms. This is due not only to contacts improvement between the fibers and the electrodes but also to the increasing of the percolation network. The changes in  $C_p$  during curing show two peaks; the first one corresponds to the point of polymer liquefaction and the second one to the gel point. The work in progress focuses on the

reproducibility and repeatability of these measurements on multi-ply UD and QI (quasi isotropic) samples. The obtained results will be correlated with those of rheological analyses (conducted by our colleagues of the ICA -Institute Clément Ader).

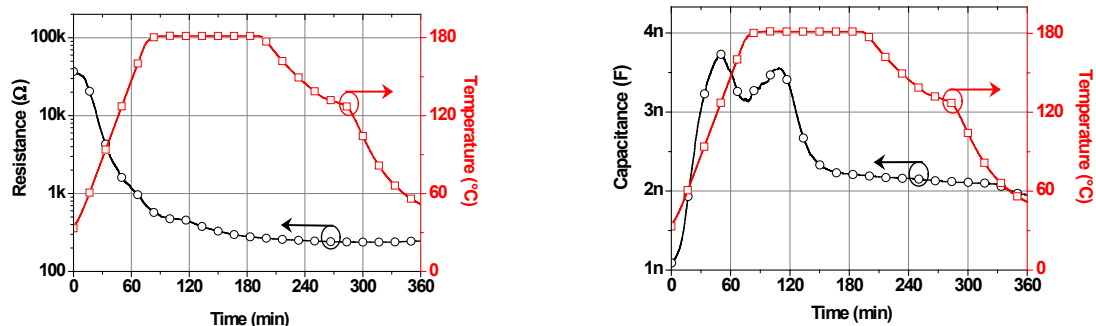

Figure 8: Inter-ply resistance and capacitance changes during curing between 22 plies

### 3 IMPEDANCE ANALYSIS FOR SHM

Keeping the same instrumentation, after-curing measurements enable us to characterize the material behavior to temperature and deformation loading. The studied samples are UD mono-ply. When the temperature of the composite increases the measured resistance ( $R_p$ ) increases but capacitance ( $C_p$ ) decreases and vice-versa. The resistance changes up to 4% and capacitance up to 15% in the range from  $-50^{\circ}\text{C}$  up to  $150^{\circ}\text{C}$  (figure 9 a).  $R_p$  and  $C_p$  measurements are also sensitive to the mechanical deformations; up to 8% and 500% respectively (see figure 9 b). These impedance measurements could enable us to detect defects inside the material such as fibers breakage, cracks or delamination. Furthermore, the material could be used as an actuator (defrost device for aerospace applications, for example).

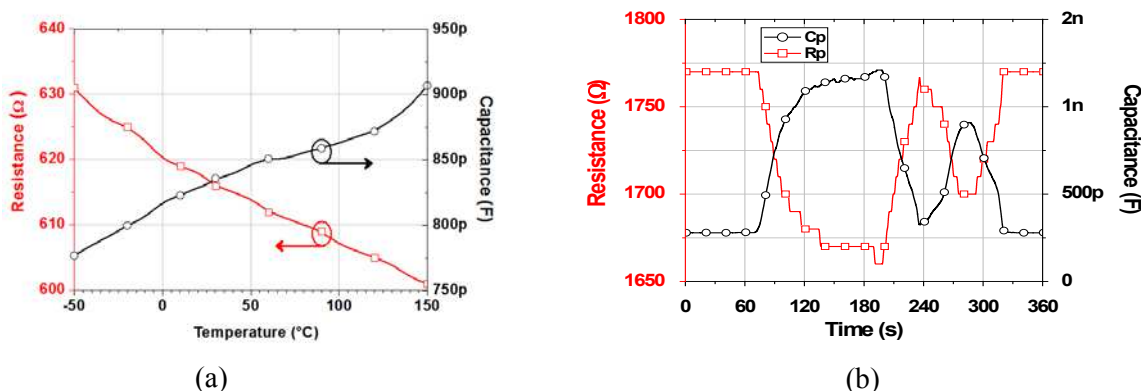

Figure 9:  $R_p$  and  $C_p$  sensitivity to temperature (a) and deformations (b)

### 4 CONCLUSION AND OUTLOOK

In this study, we developed a simple and robust instrumentation method by using flexible electrodes (flex) and an ad-hoc acquisition system designed to achieve electrical impedance measurement inside a T700/M21 composite material.

Considering a simple 3D electrical conduction, the developed instrumentation enables us to monitor the material behavior during curing (here in an oven). This later depends on the changes in

the state of the considered material. Thus it could be possible to use this instrument to monitor the curing process and better still to control it. Therefore, it should be possible to establish in real time the appropriate moments for stopping, modulating or correcting the cure cycle. This monitoring can be used to optimize the manufacturing process (energy savings, reduction of curing time etc.) and thus the properties of the manufactured material it-self.

Furthermore obtained results show the  $R_p$  and  $C_p$  sensitivity to temperature and mechanical deformations. This could enable us to ensure functionalization of the material or monitor its health during the phases of conditioning and service (SHM).

#### REFERENCES

- [1] A. Gillet, Ph. Olivier, A. A. Maghribi, I. El-Sawi. Prediction of electrical properties of an aeronautic composite. *JNC 16, Toulouse*, (2009).
- [2] Z. H. Xia, W. A. Curtin. Modeling of mechanical damage detection in CFRPs via electrical resistance. *Composites Science and Technology*, vol. 67, pp. 1518-1529, (2007).
- [3] T. Inada, A. Todoroki. Smart cure monitoring method of carbon/epoxy laminates using electric capacitance change with applied alternating current frequency. *Advances in Fracture and Strength Pts 4*, pp 2903-2908, (2005).
- [4] M. G. Maistros, K. I. Partridge. Dielectric monitoring of cure in a commercial carbon-fiber composite. *Composites Science and Technology*, vol. 53, pp. 355-359, (1995).