



HAL
open science

Deliverable D3.1-Design document of the Location algorithms

M. Garcia, V. Suvorkin, E. Quaglietta, M. Samra, Julie Beugin, S. Di Martino

► **To cite this version:**

M. Garcia, V. Suvorkin, E. Quaglietta, M. Samra, Julie Beugin, et al.. Deliverable D3.1-Design document of the Location algorithms. Rokubun. 2021. <hal-04488067>

HAL Id: hal-04488067

<https://hal.science/hal-04488067v1>

Submitted on 4 Mar 2024

HAL is a multi-disciplinary open access archive for the deposit and dissemination of scientific research documents, whether they are published or not. The documents may come from teaching and research institutions in France or abroad, or from public or private research centers.

L'archive ouverte pluridisciplinaire **HAL**, est destinée au dépôt et à la diffusion de documents scientifiques de niveau recherche, publiés ou non, émanant des établissements d'enseignement et de recherche français ou étrangers, des laboratoires publics ou privés.



HAL Authorization



Deliverable D3.1

Design document of the Location algorithms

Project acronym:	PERFORMINGRAIL
Starting date:	01/12/2020
Duration (in months):	31
Call (part) identifier:	S2R-OC-IP2-01-2020
Grant agreement no:	101015416
Due date of deliverable:	Month 11
Actual submission date:	31-10-2021
Responsible/Author:	Miguel Garcia (ROK)
Dissemination level:	PU
Status:	Issued

Reviewed: no

Document history		
Revision	Date	Description
0.1		First issue
0.2	2021-10-14	Added comments from Simon Chadwick (Siemens)
0.3	2021-10-21	Added section on Track-matching as well as comments from Network Rails in this new section Added comment on dynamically monitoring the train length for the train integrity warning system.
1	2021-10-23	Final version for JU review

Report contributors		
Name	Beneficiary Short Name	Details of contribution
Julie Beugin	UNI EIFFEL	Contribution to Section 5 (GNSS in European rail signalling systems) Contribution to Appendix A (Synthesis of related projects) Contribution to Section 6.1 (Localisation safety)
Mohamed Samra	UoB	Contributed to Section 7 mapping feared events into GNSS Signal. Contributed to Section 10.3 on railway signalling simulator.
Miquel Garcia Vladimir Suvorkin	ROK	Document outline preparation and partner coordination Mapping and modelling of GNSS into feared events Interface definition between Railway and signalling simulator GNSS + IMU loosely coupling algorithm definition.
Sergio Di Martino	CINI	Contribution to Section 3 (Map Matching techniques)
Egidio Quaglietta	TU Delft	Contributed to define and categorize feared GNSS events for Moving Block and Virtual Coupling railway operations. Contributed to identify scenarios and railway operations critical to TIM and GNSS location algorithms. Defined requirements for TIM algorithms for both passenger and freight trains General document review.

External Reviewers
Simon Chadwick (simon.chadwick@siemens.com), Siemens
John Alexander (John.Alexander3@networkrail.co.uk), Network Rail



Funding

This project has received funding from the Shift2Rail Joint Undertaking (JU) under grant agreement No 101015416. The JU receives support from the European Union's Horizon 2020 research and innovation programme and the Shift2Rail JU members other than the Union.

Disclaimer

The information in this document is provided "as is", and no guarantee or warranty is given that the information is fit for any particular purpose. The content of this document reflects only the author's view – the Joint Undertaking is not responsible for any use that may be made of the information it contains. The users use the information at their sole risk and liability.



Table of Contents

Executive Summary	6
Abbreviations and acronyms	7
1. Background	8
2. Objective/Aim	9
3. GNSS in European rail signalling systems	10
4. GNSS Assistance technology	12
4.1. Localisation safety	12
4.2. Fault detection and exclusion	14
4.3. Map Matching techniques	15
4.3.1. Track-matching	16
4.4. Multi-sensor integration	19
4.5. Position integrity techniques	19
5. Feared events and mapping into GNSS signal	22
5.1. Mapping feared events into GNSS signal issues	24
5.1.1. Limited visibility	24
5.1.2. Multipath	26
5.1.3. Spoofing	29
5.1.4. Loss-of-lock in GNSS phase measurements	30
6. GNSS + IMU hybridization	30
6.1.1. Loosely coupling integration	32
7. Train integrity	35
8. Railway and location simulators	37
8.1. Architecture	37
8.2. Interface	38
8.3. Signalling simulator	40
8.4. Continuous Integration and Deployment	41
8.5. Train split detection	42
8.5.1. TIM algorithm requirements	43
9. Conclusions	46



10.	References	47
A.	Appendix A: GNSS projects related to railway signalling	50



Executive Summary

The objective of Performing Rail task 3.1 and its deliverable (this document) is to review the usage of existing satellite-based navigation systems and services in the context of Global Navigation Satellite Systems (GNSS), the potential GNSS signal deficiencies that might occur in a railway environment and its ultimate impact in the train position. In addition, the document proposes methods and techniques to attempt mitigating these effects.

In addition, the document contains the algorithm description of the proposed techniques, as well as a potential integration of a software based GNSS simulator, developed in the context of the project within a railway signalling system simulator.

As a state of the art, this deliverable relies on published articles, past projects deliverables, and information given by the Performing Rail partners with a background in rail engineering. It is also the foundation of the algorithms and techniques to be implemented, developed, and tested during WP3

Abbreviations and acronyms

Abbreviation / Acronyms	Description
AoA	Angle of Arrival
CSV	Comma separated value
EGNSS	European GNSS
ERTMS	European Railway Traffic Management System
ESA	European Space Agency
FDE	Fault Detection and Exclusion
GBAS	Ground Based Augmentation System
GLS	GNSS Location Simulator
GNSS	Global Navigation Satellite System
GSA	European GNSS Agency
IMU	Inertial Measurement Unit
INS	Inertial Navigation System
NLOS	Non-Line Of Sight
PNT	Position Navigation and Timing
RAIM	Receiver Autonomous Integration Monitoring
RSS	Railway signalling simulator
RSS	Railway Signalling Simulator
RTT	Round Travel Time
SBAS	Satellite Based Augmentation System
SBAS	Satellite Based Augmentation System
TCP	Transmission Control Protocol
UWB	Ultra-wideband



1. Background

The present document constitutes the Deliverable D3.1 “Design document of the Location algorithms” and it incorporates the work undertaken under T.1.1 and is the first deliverable of WP3. The contents of the task are summarized as follows:

- Identify which is the **state-of-the** art in terms of feared events in a railway environment, in the context of GNSS
- Perform a **review of feared events** (both system and local) and characterize threats in terms of their impact on code and carrier phase measurements.
- Assess **impact** of feared events in GNSS observables
- Design of a multi-frequency and multi-constellation **GNSS processing engine with IMU** integration
- Define simulation guidelines to model such events in GNSS observable



2. Objective/Aim

This document has been prepared to provide both a background and state of the art of the GNSS technology in the railway environment, as well as a definition of the algorithms to be implemented to simulate GNSS signal and potential deficiencies that might occur in a railway environment. In addition, a method to check whether the train is integer or not based on GNSS is being proposed.

This software-based GNSS simulator will be used during the validation phase of the project to simulate various feared events and its impact in the context of the railway moving block.

There are no deliverables that can be considered as an input for D3.1. The content of this deliverable will be used by:

- PERFORMINGRAIL D3.2 Location algorithm software (software component delivered obfuscated within a Docker image)
- PERFORMINGRAIL D3.3 Multi-frequency/constellation GNSS receiver: MEDEA receiver. To be used during the validation phase in field test campaign.
- PERFORMINGRAIL D3.4 Location algorithm validation report.

3. GNSS in European rail signalling systems

Recent advances in GNSS applied in the rail environment have been fostered by several public institutions and a clear roadmap has been defined since 2015, spanning at least up to 2022, as shown in the following diagram.

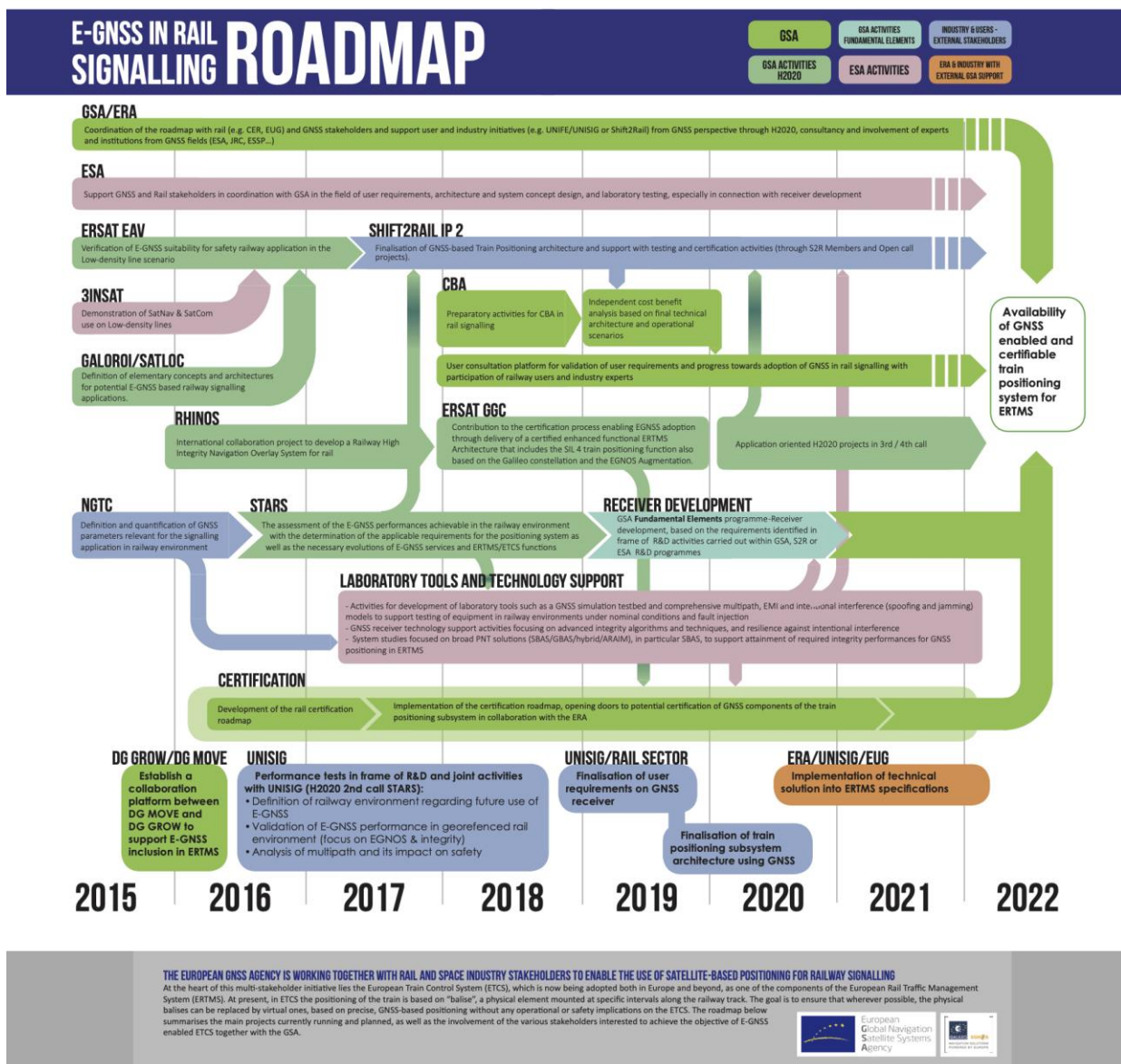

Figure 1: Roadmap for E-GNSS in rail signalling. Source: GSA¹

¹ <https://www.gsa.europa.eu/sites/default/files/rail-roadmap2018.pdf>



The main topics addressed during these projects are:

- GNSS performance estimation
- Technological bricks of a GNSS-based system
- Architecture of on-board GNSS-based systems
- Architecture of on-board ETCS localisation system
- Operation of a railway line with GNSS
- Identification of a pilot line
- Safety process for certification
- Cost-benefit analysis

A first recent specific step in EU regulations towards the introduction of GNSS in ERTMS is the proposal, to the EUAR², of a Change Request³ (CR 1368) for the evolution of CCS TSI (Technical Specifications for Interoperability) including ERTMS specifications [UCP-Rail 2020]. The EUSPA and ESA supported this ERTMS Users Group's CR 1368. This CR objective is to ensure availability of EGNOS correction data in ETCS on-board through the ERTMS/EURORADIO communication protocol. It aims to facilitate possible inclusion of GNSS augmentation data in the CCS TSI 2022 as the first step towards GNSS adoption within fail-safe train localisation in ERTMS/ETCS.

A comprehensive list of projects related to GNSS applied to the railway environment can be found in [Marais et al, 2017] and in the [Appendix A: GNSS projects related to railway signalling](#), found in this document.

² EUAR (ex-ERA) = European Union Agency for Railways. In particular, it manages the CCS TSI available on <https://www.era.europa.eu/content/ertms>

³ Any modification to the ERTMS specification is analysed via a Change Request by EUAR through the Change Control Management platform (restricted access on <https://ccm.era.europa.eu/cqweb>)

4. GNSS Assistance technology

4.1. Localisation safety

The safe localisation of a train mainly relies on on-board odometry equipment and trackside balises, deployed all along the railway track in order to allow the on-board control system to measure a relative distance for positioning the train on the track coordinate system. In CCS TSI European regulation ([EU, 2016]), such equipment are basic Interoperability Constituents (IC) of ERTMS and are today provided by suppliers with safety conditions compliant to SIL 4 (Safety Integrity Level 4, cf. EN 50126 and EN 50129 CENELEC standards). Replacing such safe ICs with GNSS-based equipment is possible and a lot of projects worked on it (see section 5). However, the same safety level has to be reached to comply with the railway CSM-RA (EU regulation 402/2013: “Common Safety Method for Risk Evaluation and Assessment” [EU, 2013]), i.e. a THR (Tolerable Hazard Rate) of 10^{-9} failure/operating hour, related to SIL 4, has to be demonstrated [Beugin et al., 2018].

Different functional and technological architectures have been investigated in the different European (and national) research projects dealing with GNSS localisation for railway signalling systems. They first sought to obtain GNSS-based systems robust to feared events coming from the railway environment. Indeed, the immediate vicinity of a railway line can cause deleterious effects on position estimations as they are derived from perturbed GNSS signals (and the user is not aware that the estimated position can have an error greater than tolerated). Environment obstacles (such as vegetation, buildings, hills, railway cuttings, etc.) can hinder GNSS signal reception as these low-power signals are unable to penetrate dense materials. These obstacles can also provoke local propagation phenomena such as signal reflection, diffraction, and refraction, which might bias the position estimation process. Different integrated systems, hybridizing a GNSS receiver with other sensors, were also investigated not only for improving the localisation quality, but also for ensuring the localisation continuity in locations without GNSS signal reception, like tunnels. As a result, for ensuring railway needs in terms of availability, continuity and safety, a GNSS-based localisation system will always require an integrated solution combining a GNSS with other localisation sources.

Different safety-related techniques and methods, stemming from the aeronautical field, have also been investigated, since GNSS were originally designed to meet aeronautical needs (e.g. the use of augmentation systems or the use of failure detection mechanisms with localisation integrity monitoring).

Also, different types of redundancies have been tested, ranging from simple sensor redundancy to complex redundant channels according to an M out of N voting structure.

In the various proposed architectures, three categories of components can be distinguished:

- Hardware components (GNSS receiver associated with other sensors, e.g. inertial units, accelerometers, tachometers, etc.) whose output signals lead to raw localisation data,
- Digital data used to improve localisation data; they come either from databases linked to the topology and the topography of the railway tracks (a digital map makes it possible to realize map-matching) or from a satellite augmentation system (EGNOS in Europe) or a ground based-augmentation system,
- Software algorithms to, on the one hand, combine the heterogeneous information coming from the physical and/or digital data sources mentioned above and, on the other hand, to detect faults or provide a confidence interval (most often in terms of the maximum position error around the estimated position).

The figure below represents different architectural options (combining hardware and software components) that have been investigated in the various projects presented later in the document and Appendix A in order to obtain a GNSS-based Fail-Safe Train Positioning Systems (FTPS). The FTPS are either dedicated to implement the virtual balise concept⁴ or to implement a standalone GNSS-based solution.

When developing such architectures, some recent projects began to gather and structure the needed set of safety evidence for attesting that all safety conditions are guaranteed when the GNSS-based localisation system will be used for train operation. They sought to detail this set of evidence in a documentation structuring the safety argumentation. Indeed, this corpus of documents presents all the safety demonstrations to be examined by an ISA (Independent Safety Assessor) and needed to obtain the certification and the legal authorization for putting the system into service. All studies in these documents especially employ hazard and dependability analyses, as well as RAMS (Reliability, Availability, Maintainability and Safety) evaluation methods, as required by the railway safety CENELEC standards.

However, a challenging safety issue still remains and can be expressed with the following question: are all existing errors due to discontinuities and localisation integrity problems caused by the railway propagation environment, correctly and efficiently mitigated to make the residual risk acceptable? It is indeed useful to recall that a train crosses an indefinite number of environmental configurations, which might more or less impact the GNSS signal quality, the worst case being the urban dense environment and the ideal case being the open-sky environment. This variability associated with the variability of the satellite constellation configuration makes it impossible to

⁴ Virtual Balises are georeferenced points recorded in a database embedded in train computer. They can replace Physical Balises (PB) by keeping existing ETCS Levels 1 and 2 specifications and reference architecture unchanged. The VB function is planned to be accomplished using the on-board GNSS receiver as follows: a VB reader periodically computes the train GNSS position and compares it with the locations associated with the VBs. The VB function is activated when the estimated train position matches the stored VB position in the database. The balise information (the telegram) is then obtained also from the on-board database.

predict GNSS signal perturbations. Signals reflected by the environment surrounding the railway led to non-line-of-sight (NLOS) undesirable signals that are today not characterized enough in this environment, albeit they have been studied in other environments such as in aircraft and automotive domains (see for instance [Bauer et al., 2015] and [Obst et al., 2013]). Electromagnetic interferences have also to be taken into account and identified. They can be intentional (spoofing) and non-intentional interferences (e.g., is the noise emitted by catenaries significant or not).

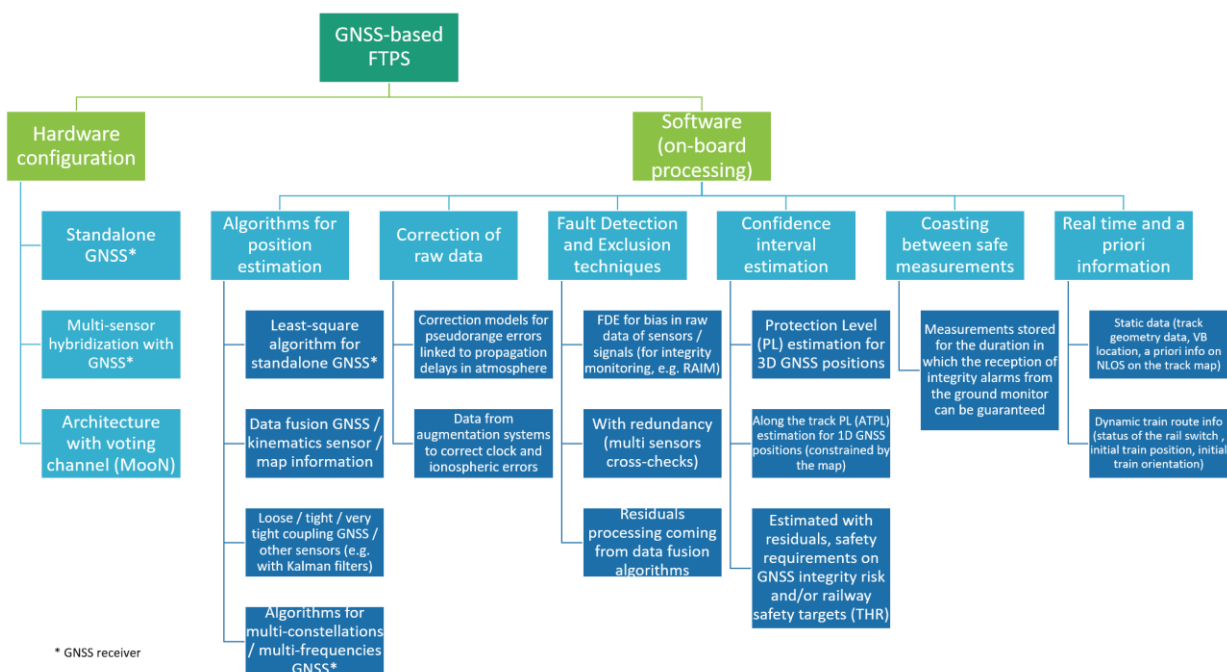

Figure 2: Diagram of possible GNSS-based Fail-Safe Train Positioning Systems

4.2. Fault detection and exclusion

Fault Detection and Exclusion (FDE) algorithms are used in railway system to cope for local feared events in the context of GNSS. FDE need to be defined for different types of GNSS equipment and scenarios; e.g. the algorithms used for a single-frequency GNSS receiver (typically GNSS L1, at 1.575GHz) might differ from those applicable to a GNSS receiver able to track more than one frequency. The same applies for the case where the receiver tracks only GPS (i.e., single-constellation) or more (GPS, Galileo, Beidou, Glonass, ...=). In the context of these FDEs, perform a technology assessment and review of the state of the art for methods and techniques to improve the robustness of carrier phase tracking in the railway environment, to enable use of carrier phase

measurements as possible monitoring techniques.

Definition of the logic for Fault Detection and Exclusion (FDE) based on the outputs generated by the processing engine. The FDE scheme will account for the tightly coupling of Global Navigation Satellite Systems (GNSS) and Inertial Navigation System (INS). The aim is to ensure navigation integrity and to provide robustness with respect to failures of both GNSS and additional sensors, e.g., IMU.

4.3. Map Matching techniques

The purpose of this section would be to give an insight on how map matching, which is a technique widely applied in many domains, like the automotive one, could be eventually applied in the railway environment.

The underlying intuitive idea is that, since the vehicle runs on the roads, an accurate trajectory sampled from a GNSS installed on a vehicle should always lie on a road segment belonging to the map. Consequently, the map-matching problem has been studied for more than two decades to improve localization of vehicles.



Figure 3: Example of inaccurate GNSS locations (in blue) from the CabSpotting Project in San Francisco (USA). In Red the underlying road network from OpenStreetMap

In the literature, map-matching solutions can be classified into *online* and *offline* techniques. In

the online map-matching case, the continuously sampled vehicle positions are processed in a streaming fashion, i.e., the map-matching is continuously performed on the current sample with a limited number of preceding or succeeding samples. The process is usually simple and fast for interactive performance, in order to be computed also on the limited resources available on-board.

On the contrary, an offline map-matching is performed after the entire trajectory is obtained. In this way, it is possible to aim for a much better positioning, as it is possible to also consider positions in the future with respect to the currently processed one. Moreover, often offline map-matching is performed off-board, in data centres, thus posing less constraints to the algorithms in terms of required computational resources.

Focusing on the railway domain, the task of map-matching comprises (I) identifying the correct track segment which the train is moving on, among the candidate links, and (II) determining the vehicle location on that track segment.

In most of the applicative scenarios, an online map-matching is required, as the position has to be precisely determined more or less in real-time. Off-line scenarios are more useful for maintenance tasks, such as the one investigated in the Italian funded project “OCTOPUS”.

When dealing with map-matching in the railway context, the main challenge arises in the presence of parallel tracks. Indeed, detecting whether a train is moving on the right or left track is very important for safety-relevant applications, such as track vacancy detection. Let us note that, in contrast to a map-matching for determining the position of road vehicles, map-matching of a train position results in an unambiguous allocation of the train to one track, since, differently from a car which can drive across two lanes, a train cannot be located between two (parallel) tracks.

To solve this issue, in the literature there are some proposals aiming at performing data-fusion among multiple data sources, including also a map (e.g.: [Gerlach and Rahmig, 2009]). For our goals, it results particularly relevant the work by M. Lauer and D. Stein ([Lauer and Stein, 2015]), where authors proposed a technique to improve positioning of a train, with a special emphasis on the safety, leveraging also online map-matching, advanced pre-processing, filtering and fusion techniques. In addition, map- (or track-) matching algorithms could be also applicable not only to improve position but also for track discrimination.

4.3.1. Track-matching

Given that the train might potentially have detailed information of the track in which it circulates, a track-matching algorithm can be also put in place (in a similar way as road navigation devices perform map matching). In fact, having a description of the track allows to convert the 3D

positioning problem to a 1D positioning problem (see for instance [GRAIL, 2007]). Actually, different strategies for track-matching can be considered: a “loosely” coupled strategy in which the GNSS position is later matched to a nearby track, as shown in the simulation performed by Rokubun:

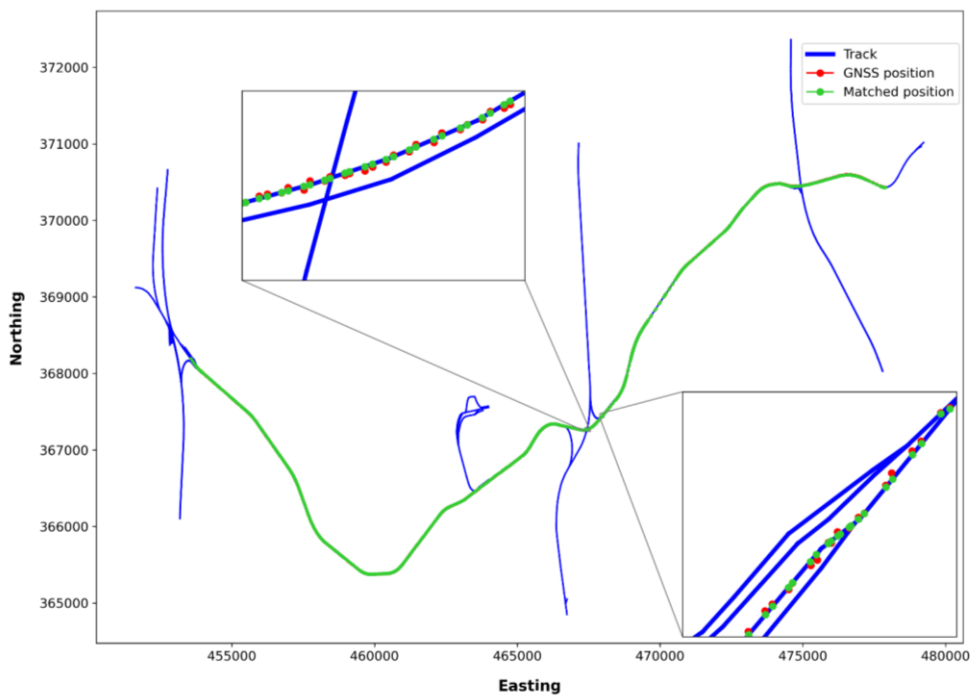

Figure 4. Example of track matching algorithm with simulated GNSS position (with noise, in red) and its corresponding snapped position in the track (in green)

However, other strategies similar to the “tightly” coupled employed in a GNSS+IMU hybridization could be potentially considered. In this strategy, the next position of the train in the navigation filter could be constrained. The two strategies could be summarized in the diagram below:

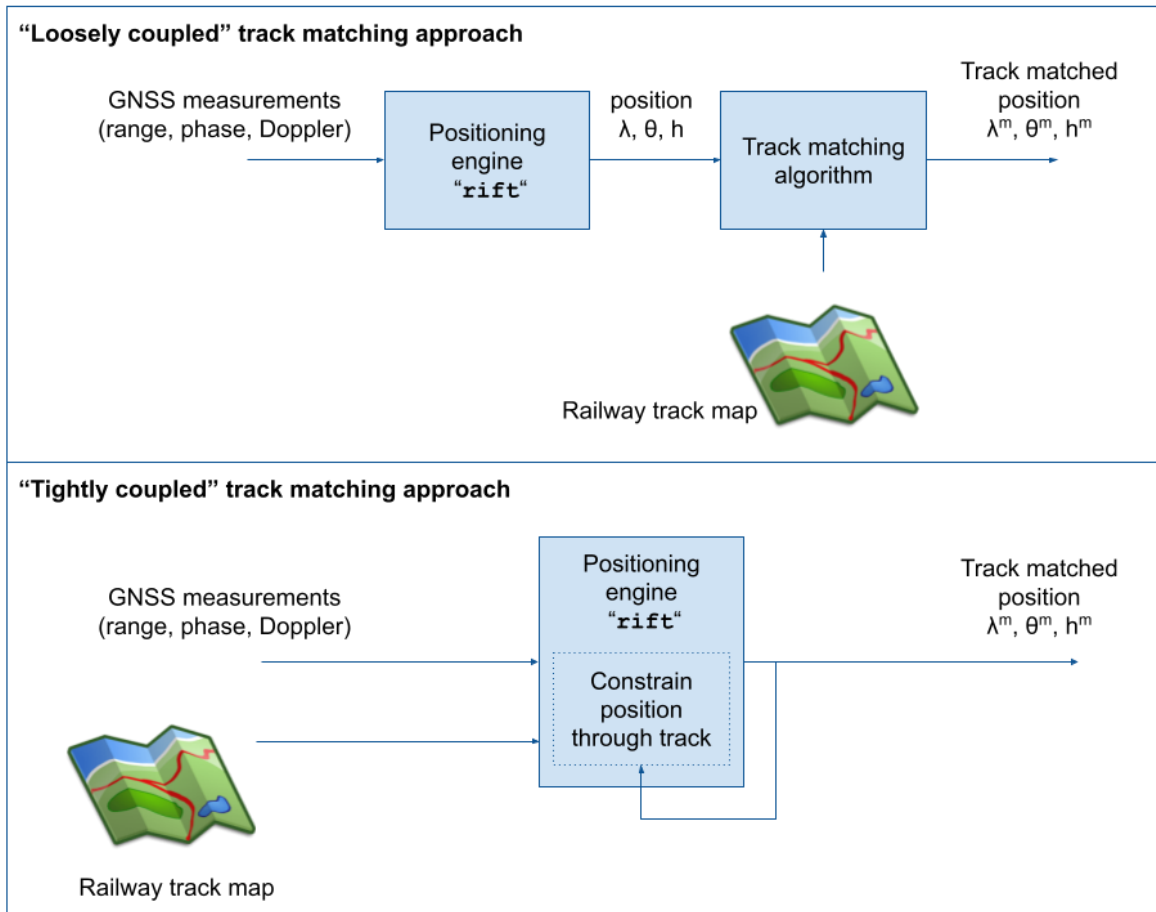

Figure 5. Usage of railway track maps to improve the position given by GNSS positioning system using two different coupling (loose and tight) strategies

In summary, once a train has been localised onto the railway network using GNSS and other measures then using GNSS to track its progress along the railway using the available and set routes can be a robust process. There are very few occasions where the longitudinal position along a track needs to be to a greater accuracy than can be achieved with GNSS. Looking at the current train position mechanisms within ETCS, the odometry can generate significantly larger uncertainties.

A potential issue to address in a track-matching is establishing which track a train is which was not previously localised. Also, reporting the accuracy/confidence of GNSS in many railway locations may not be enough to distinguish between adjacent tracks. Therefore, other measures may be required to confirm the location of the train before the signalling can make safety related decisions and authorise train movements.

4.4. Multi-sensor integration

As it is known, GNSS is the de-facto navigation technology to achieve decimetre to meter level accuracy (depending on the equipment used). GNSS is nowadays a mature technology and is augmented with ancillary systems such as Satellite Based Augmentation Services (SBAS) that can provide with service quality and integrity information.

However, GNSS can have potential limitations (only outdoors, vulnerable to interference and spoofing attacks, signal degradation in certain scenarios...) and it is clear that GNSS alone cannot provide by itself a complete and whole navigation solution. Therefore, besides inertial measurements discussed, later in the document, alternative sources or data of opportunity are currently explored to complement GNSS and/or provide with alternate Position, Navigation and Timing (PNT) solutions. Current technologies that are being proposed can be summarized as follows:

- **Round Time Travel (RTT)** techniques, where sensors provide a measure of the time between the receiver and access points or transmitters. These techniques are range based (just like GNSS) and can be found in Wi-Fi protocols (802.11mc protocol), Ultra-wideband (UWB) or even 5G. See for instance [De Angelis et al. 2016], [Gentner et al. 2020] and references therein.
- **Angle of arrival** techniques, where transmitters transmit a signal so that receivers are able to measure the angles of the signal and derive the position (see for instance [Torrieri, 1984] and [Pages-Zamora et al. 2002]). Current chipset manufacturers such as u-blox⁵ are pushing towards this technology.
- **Magnetic field** techniques, where magnetic field maps are constructed and later used in e.g. particle filters, to estimate the position where GNSS is not available (see for instance [Solin et al. 2018] and references therein)
- **Vision-based** techniques, where patterns found via image sensors, can be used as reference points to extract position estimates.

One of the advantages of using these alternate technologies is not only the possibility of having a position estimate in areas where GNSS is impaired, but also to perform double-check

4.5. Position integrity techniques

In GNSS, “integrity is the measure of the trust that can be placed in the correctness of the information supplied by a navigation system” ⁶. The integrity referred in this section is not to be confused with the term “train integrity”, used later in the document, that refers to the detection

⁵ See for instance <https://www.u-blox.com/en/product/xplr-aoa-1-kit>

⁶ Definition extracted from <https://gssc.esa.int/navipedia/index.php/Integrity>

of a train split. Positioning integrity was introduced in GNSS in the aeronautical sector to guarantee the provision of position in safety-of-life applications (see for instance [Spilker et al. (eds) 1996]).

The integrity status of a positioning system is usually represented by the so-called Stanford (or “triangle”) plots shown in the figure below and introduced in [Walter et al. 1999]. This diagram is built upon several parameters defined as follows:

- Positioning Error (PE) is the estimation of the position error relative to the true position. In normal operations, the true position is not known, and thus this position error is computed using the formal error provided by the navigation filter.
- Alert Limit (AL): The alert limit is the maximum allowable position error, beyond which the system should be declared unavailable for the intended application. Usually, the alert limit is distinguished from horizontal and vertical limits.
- Protection Level (PL) is a statistical bound of the position error computed to guarantee that the probability of the absolute position error exceeding said bound is smaller than or equal to the target integrity risk. In order for the system to be usable, the protection levels must be below predefined thresholds known as alert limits.

The plot is divided into several sections. The upper part (unavailable service) indicates that the protection level (PL) is larger than the alert limit (AL) and thus the service is not usable. The Hazardous and Misleading Operations indicate that the PE is large enough to issue a warning. Finally, nominal operations (above the diagonal) indicates that the PE is lower than both PL and AL.

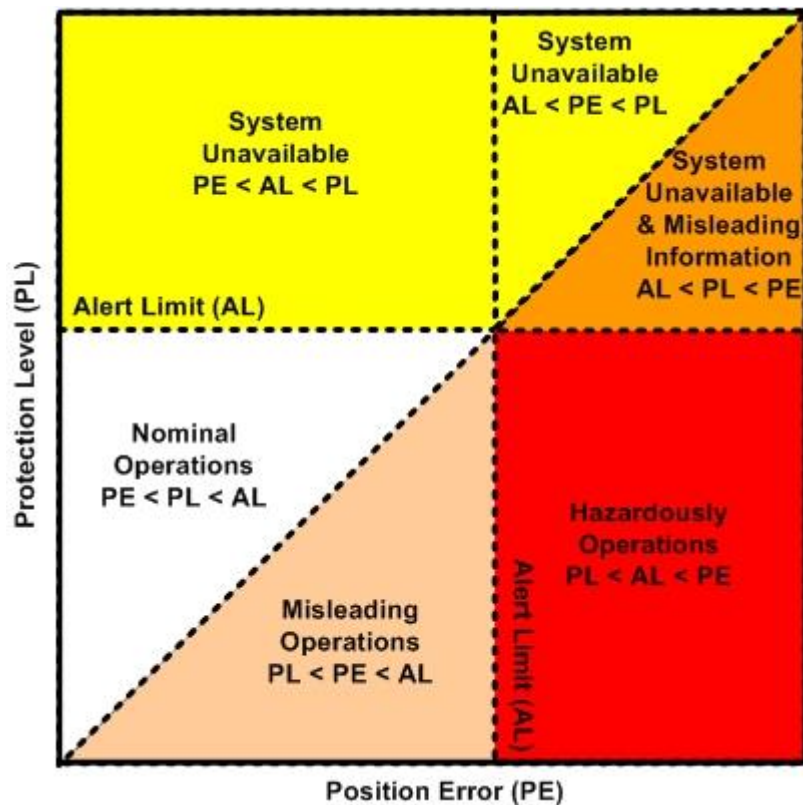

Figure 6. Stanford plot definition to monitor position integrity

Despite the fact that integrity is a concept mostly used for aircraft operations. A similar concept could be used for railway operations. In this case, **protection levels would be mostly applied to horizontal dimension**. Therefore, the system would define horizontal protection level (HPL), horizontal position error (HPE) and horizontal alert limit (HAL).

Integrity information can be provided to users through various strategies, in increased complexity:

- Receiver Autonomous Integrity Monitoring (RAIM), the receiver computes the position using various combinations of measurements to detect faulty measurements and provide an upper bound of the positioning error.
- Ground Based Augmentation System (GBAS), it involves a ground-based infrastructure of several GNSS receivers per site (for instance an airport) that compute their position and build both corrections and integrity information for target devices (for instance a GNSS onboard an aircraft)
- Satellite Based Augmentation System (SBAS), in this case a network of ground GNSS receivers jointly compute a series of position corrections as well as integrity information so that they can be later related to target devices via a geostationary satellite. An example of the SBAS system is the European EGNOS.

5. Feared events and mapping into GNSS signal

As it is known, GNSS can be affected by several factors that can potentially degrade the precision and accuracy that can be achieved in the receiver. Several past activities and projects have listed several feared events in the railway environment that might affect GNSS. Potential examples found in e.g., Section 3.4 of [NGTS, 2015], Section 2 of [GATE4RAIL, 2019], Section 3 of [STARS 2018a] are:

- Lack of visibility (total when entering a tunnel or partial when entering a narrow valley)
- Increased multipath (train under canopy, within urban canyon, ...)
- Sudden loss of lock of one or various GNSS satellites (e.g. passing near a tall building, ...), this would translate in an increased number of cycle slips in the GNSS carrier phase
- Inaccurate and/or unreliable position measurements. Inaccurate position reports might be very dangerous for e.g., Virtual Coupling if trains are running at a very short distance from each other. In general, GNSS devices usually report a position error estimate, but this error is a formal value and might differ to the actual position error.

In addition to these factors, RF interference such as jamming or even spoofing, Electromagnetic Interference or EMI for short, are also relevant in a railway scenario ([ASTRAIL, 2018a]) and can actually have critical implications in the integrity of railway operations ([ASTRAIL, 2018b]).

The listed set of feared events could raise significant safety risks in both moving block and Virtual Coupling railway operations, as the Radio Block Centre (RBC) would partially or totally miss the correct information on position and integrity report from trains on the track. In that case, the RBC would hence be unable to provide a safe and reliable Movement Authority to the trains, resulting in the need of applying an emergency braking to bring the trains to stop, to reach a fail-safe system condition. Discontinuous, inaccurate, or unreliable GNSS position measurement, would be particularly critical for Virtual Coupling operations, as even the application of emergency braking could potentially lead to collisions of trains travelling at less than an absolute braking distance in a convoy or a platoon, especially if a train has braking rates lower than the train ahead. Extra safety margins shall hence be added onto the separation distance under Virtual Coupling to account for heterogeneity in braking characteristics across the different train categories operating on a railway network.

A summary of the most critical feared events considering past references are summarized in the following table. The table also includes a description on how the feared event affects (i.e., maps into) GNSS system and which are the possible mitigation techniques that can be used or applied in order to alleviate the impact due to each of these listed hazards.

Feared event	Origin	Mapping into GNSS	Potential mitigation in GNSS processing engine
Total loss of visibility (e.g., train into tunnel)	environment	No GNSS data is available to the receiver	Position propagation with Inertial sensors
Partial loss of visibility (e.g., train in narrow valley or urban canyon)	environment	GNSS satellites removed according to an elevation mask	Position propagation with Inertial sensors
Increased multipath (e.g., train under canopy or within urban canyon)	environment	Increase of noise of low elevation observations	SNR-based weighting of observables. Tighten elevation mask
Interference from Jamming and signal distortion	environment	Increase noise level of observables (both high and low elevation observables)	SNR-based weighting of observables.
Spoofing	intentional	While the carrier and phase GNSS observables to be modelled (to compute the prefit residuals) will take the a priori position of the train, the observed GNSS observables (that will need to be synthesized) will be computed using the spoofed position. This creates a mismatch within the positioning engine.	Measurement hybridization of additional sensors. Check range dynamics with inertial sensors.
Loss of lock in carrier phase measurements	environment	Increase of cycle slips	Reject observations from a given satellite in the event of high number of cycle slips
Inaccurate or unreliable measurement	environment or GNSS devices	Modification of the GNSS receiver position relative to the true position beyond the formal error reported by the receiver.	Data fusion by integrating other data sources to align the measurement with required safe levels of reliability and accuracy. Usage of GNSS integrity techniques such as Receiver Autonomous Integrity Monitoring (RAIM) or other such as GBAS or SBAS

5.1. Mapping feared events into GNSS signal issues

This section includes the models, to be implemented in the GNSS location simulator (GLS), in order to simulate the existence of the different feared events listed in the table above.

The GLS consists of two different basic modules:

- **argos**, that will simulate the GNSS range measurements (i.e., pseudorange and carrier-phase measurements) for a given point or trajectory, based on a certain configuration and
- **rifft**, that includes the positioning filter, that converts from GNSS range measurements to position estimates.

In ideal conditions, if the same input is used to simulate the GNSS ranges (i.e., satellite orbits and clocks, same noise characteristics, ...) the position generated by **rifft** should be the same as the position used in **argos** to compute the GNSS range measurements. However, this pipeline can be used to simulate errors that might occur in a GNSS scenario (i.e. effect of reduced quality of the satellite broadcast orbits and clocks, ionospheric disturbances, ...). The same principle will be applied to simulate the feared events listed above. Therefore, each section below will include the working principle of the simulation of each event as well as the means to configure these events in the GLS.

5.1.1. Limited visibility

Limited visibility consists in the loss of satellites due to the presence of blocking elements such as buildings, overpasses, tunnels, nearby mountains, ... An example of an elevation mask is shown in the figure below. The figure shows that, for a given position that has certain environment (the digital elevation map corresponding to this given position is shown in the right panel of the figure), there will be certain points (shown in the left panel of the figure below), represented by an azimuth and elevation, that will be blocked.

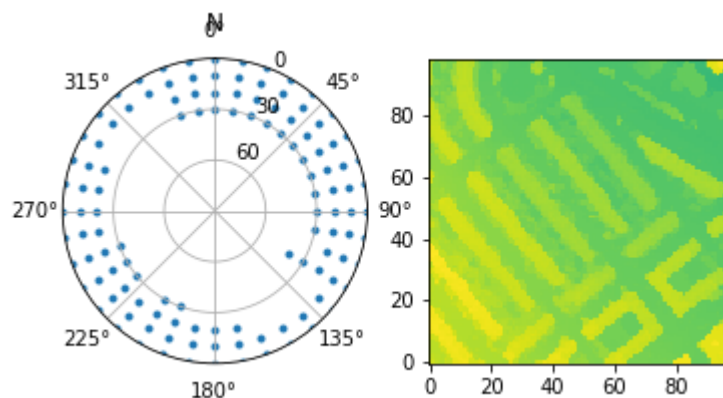

Figure 7. Example of elevation mask in an urban environment. Left panel is an

Azimuth/Elevation plot with the elevation mask (blue dots indicate obstruction) and right panel is the digital elevation map (clearer parts are higher points) used to generate the mask (the point being represented in the Az/El plot is the middle of the square, coordinates 50,50)

In order to simulate parts of the route with lack of visibility, a position dependent elevation mask can be set-up at the GNSS range measurement simulation tool (i.e., the **argos** tool). When the GNSS measurements for a given position need to be synthesized. If the azimuth and elevation for a given satellite falls in a blocked area, this satellite will be skipped.

The processing engine (**rift**) will then need to compute the position with a reduced number of observations.

Configuration-wise, elevation masks will be defined using a text file that will contain various blocks, one per each position that needs to be simulated.

```
<latitude1_deg>,<longitude1_deg>,<range_m>,<Naz>,<Nel>,<Daz>,<Del>  
<Az.1>,<El.1>,...<El.Nel>  
...  
<Az.Naz>,<El.1>,...<El.Nel>
```

The definition of each field is as follows:

- `<latitude1_deg>`, `<longitude1_deg>`, are the geographical coordinates (in degrees) at which the elevation mask applies. `<range_m>` indicates the range (in meters) relative to the coordinates at which the mask applies.
- `Naz` is the number of Azimuth lines that follow
- `Nel` is the number of Elevation values per each azimuth
- `Daz` and `Del` are the azimuth and elevation step of each point
- `Az-1` is the starting azimuth. Therefore the azimuthal range will go from `Az.1` to `Az.1+Daz`. Similarly, the elevation value will go from `El.1` to `El.1+Del`.

Some notes to take into consideration:

- Only the blocking elements are shown in the elevation mask.
- A wildcard `*` can be used to mark all azimuths (or elevations)

For example, an elevation mask of 15 degrees for all azimuths and positions would have the following file:

```
# Elevation mask of 15 degrees for all azimuths and positions
*,*,*,1,1,15,*
0,*
```

This algorithm will be implemented in C within **argos**. In terms of programming interface, this would be represented by a class `vizmask_t` that would have the following methods:

- `vizmask_t* vizmask__create(const char* filename)`: Creates `vizmask_t` instance using the CSV filename specified in the argument. This method will open the file, parse it, and populate the necessary structure of the object.
- `enum err_t vizmask__destroy(vizmask_t** self)`: destroys an instance of `vizmask_t`, clearing all resources (i.e. memory) reserved for the instance.
- `bool vizmask__is_blocked(const vizmask_t* self, const double longitude_deg, const double latitude_deg, const double az_deg, const double el_deg)`: Checks if the given azimuth and elevation are blocked for a given coordinates. Internally, the structure holding the azimuth and elevation visibility mask will consist in a randomly accessible structure to avoid longer execution times due to search algorithms. Therefore, the incoming azimuth and elevation values will be converted to indices of a matrix (using the `Daz` and `Del` values) and thus the matrix holding the visibility mask will be accessed directly. However, the look-up of a visibility mask description for a given position (coordinates) will need to be performed using (linear or binary) search algorithms.

To configure the visibility mask, the following option (that accepts a file) will be implemented in **argos**:

```
# visibility mask option
visibility_mask_file=/path/to/visibility_mask.txt
```

If this option is present, it will override the `elevation_mask` option, already implemented in **argos**.

5.1.2. Multipath

As it is known, multipath noise is caused when direct signals are combined with their reflected versions that are generated by the environment. A simple geometric model of multipath has been defined by [Bilich et al, 2008], based on the following model:

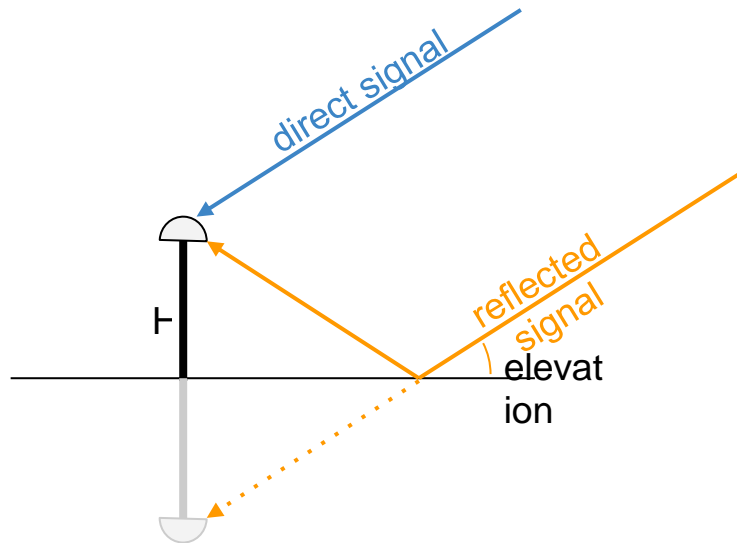

Figure 8. Simple geometric multipath model based on direct and a single reflected signal

For this model, the phase delay of the reflected signal (ψ) can be expressed using the following expression (extracted from [Bilich et al, 2008], equation 4):

$$\psi = \frac{4\pi}{\lambda} \cdot H \cdot \sin(el)$$

where H is the height of the receiver (for a train, an approximate value can be between 4 and 5 meters approximately) and el is the elevation of the incoming signal. The wavelength of the signal is represented by λ .

The following figure illustrates the effect of the multipath in the resulting range. Once the GNSS signal arrives at the receiver, the tracking loop of the receiver correlates the incoming signal with a local replica, thus generating an autocorrelation function that is triangularly shaped (blue shapes in the following plot). An additional autocorrelation function will be generated by the tracking loop for the reflected signal (orange shape), thus creating a final function that will be the addition of the direct and reflected signal (green shape). This resulting function will be a distorted function (i.e. non triangular), in particular the peak of the function will be distorted, thus creating some noise in the range measurements.

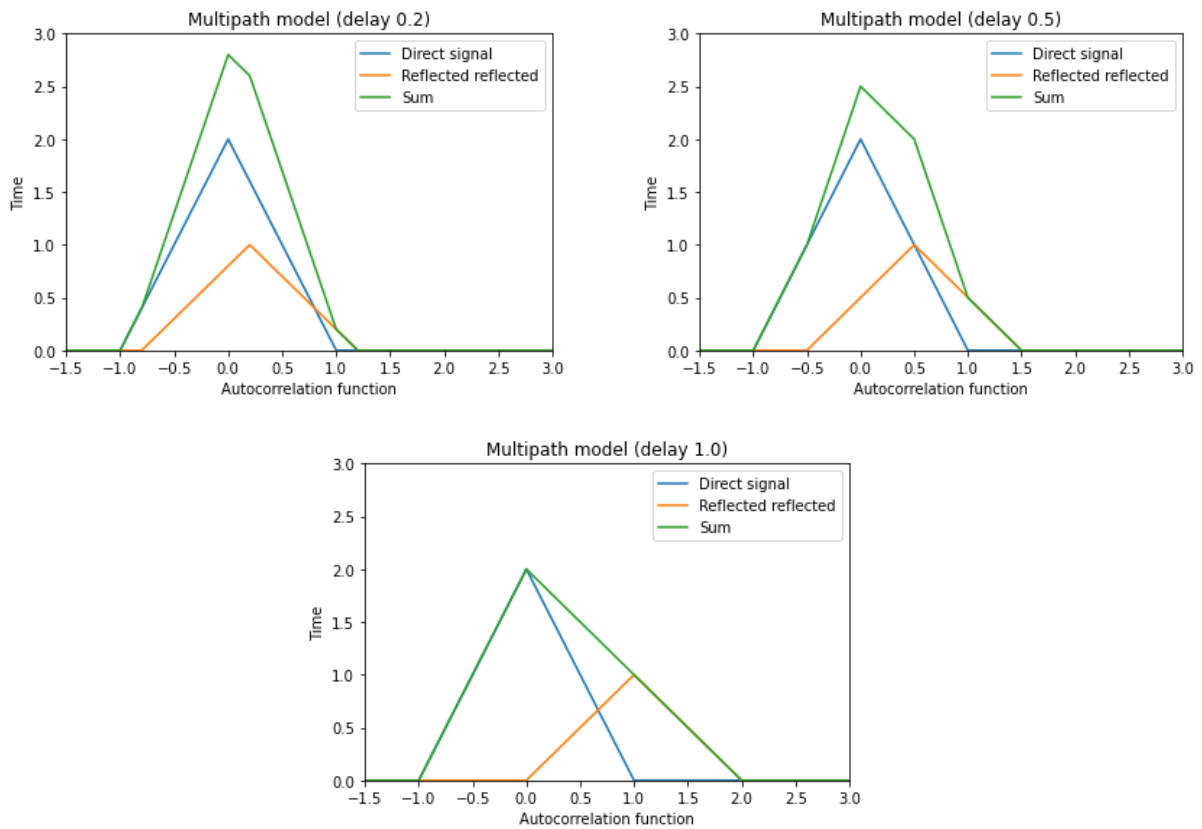

Figure 9. Resulting autocorrelation function assuming different delays of the reflected signal. The direct and reflected signals generate autocorrelation functions that, when added, generate a distorted function that causes varying noise in the resulting ranges. The three plots include the resulting autocorrelation function for different delays.

Once the delay of the reflected signal is too large, the tracking loop discriminator will usually be able to discard the reflected signal. In theory this is usually when the reflected signal arrives after the width of the autocorrelation function (which, for GNSS L1 code is one chip duration, 1microsecond or, equivalently, 300m). However, receivers usually work with tight discrimination functions will allow a stricter multipath rejection. Therefore, reflected signals delayed more than 10 meters will be ignored in the proposed model.

In summary, the resulting additional range to be added to the pseudoranges will be defined as half the phase delay provided by the expression above:

$$\Delta R_{multipath} = \frac{\psi}{2}$$

For this simple model, the only parameter that needs to be configured is the height of the receiver

(that will default to 4m). This will be done only via a single parameter in the **argos** configuration file:

```
# height for the multipath model
# This option will be under the section of each receiver, where
# applicable
multipath_receiver_height=4
```

5.1.3. Spoofing

Spoofing is a GNSS event by which an attacker broadcasts a fake GNSS signal and thus the receiver obtains an incorrect position estimate. To simulate a spoofing event or series of spoofing events, **argos** will be configured with the current (legit) trajectory, but the position at certain points will be overridden by the position defined in an external configuration file. This will result in GNSS ranges that will be generated for the spoofed position. Therefore, **rift** will result in the position of the spoofed event, instead of the actual (trajectory) one.

To configure the spoofing events, the following option (that accepts a file) will be implemented in **argos**:

```
# spoofing events
spoofing_events_file=/path/to/spoofing_events.csv
```

The content of the spoofed events CSV file will be the following:

```
latitude,longitude,range,spoofed_latitude,spoofed_longitude
<lat_deg>,<lon_deg>,<range_m>,<spoofed_lat_deg>,<spoofed_lon_deg>
```

- The latitude (<lat_deg>) and longitude (<lon_deg>) indicate the position at which the spoofing event takes place. The value <range_m> indicates the range in distance in which the spoofed event will be applicable.
- The spoofed_latitude (<spoofed_lat_deg>) and spoofed_longitude (<spoofed_lon_deg>) indicates the position that is being forged by the attacker. Therefore, **rift** will output this position if the simulated receiver is within the location of the spoofed event.

5.1.4. Loss-of-lock in GNSS phase measurements

As it is known, GNSS carrier phase measurements are more sensitive to the environment than code pseudorange. A GNSS receiver tracks the phase and stores its past history (i.e. number of cycles), when a phase break occurs (loss of lock), the receiver needs to re-estimate the number of cycles (i.e. phase ambiguity) in order to provide accurate positioning. Phase breaks (also called cycle slips) occur with higher probability when signal power drops (i.e. carrier to noise ratio) below a certain threshold.

To define the areas with certain loss-of-lock (cycle slip) probability, a CSV file with the following format is proposed:

```
latitude,longitude,range,loss_lock_probability  
<lat_deg>,<lon_deg>,<range_m>,<unit_probability>
```

where:

- `latitude` and `longitude`, expressed in degrees, defines the position at which the event takes place, which is applicable within a certain `range` (expressed in meters).
- the `loss_lock_probability` is expressed as unitary probability (from 0 to 1). Whenever an event is defined, a random number from a uniformly distributed process will be drawn. If lower than the loss-of-lock probability, then a cycle slip will be declared.

An example of a CSV for this file is provided as follows:

```
latitude,longitude,range,loss_lock_probability  
41.23,2.1,100,0.5  
41.23,2.2,200,0.5
```

Declaring a cycle slip will imply setting the carrier phase to 0, recording the phase range at that point (i.e. phase range offset) and subtract this phase range offset to subsequent phase ranges until the next phase break.

6. GNSS + IMU hybridization

GNSS navigation accuracy depends on various error sources. Some of them can be minimized by using additional data such as high accuracy satellite positions and clock biases instead of broadcast orbits, precise atmosphere models, etc. But some problems can't be solved easily: full or partial

loss of visibility, increased multipath and other reasons which do not allow to obtain a navigational solution at all or at least with sufficient accuracy. Involving inertial and other sensor data can improve the solution and even allows performing autonomous navigation in periods when the GNSS solution is unavailable.

An Inertial Navigation System (INS) is a combination of sensors (inertial measurement units, IMU) which are used for a kind of dead reckoning. Position and attitude are estimated by integrating the velocity, acceleration, and angular rate measurements of the sensors. Such a navigation system can be autonomous, though one needs to pay attention to initialization and cumulative error. Also, there is an important question about the accuracy levels of IMUs, their calibration and stability.

In general, it's correct to say that GNSS and INS complement each other, so their combination may provide a more accurate and stable solution using the advantages of both methods. The INS main problem is a cumulative error, which is more critical when less expensive sensors are used, though the short-term errors can be small. GNSS, as a more stable technique on long term intervals, can provide the boundary for INS degradation. On the other side, INS could aid to smooth GNSS trajectories on short periods of losses of visibility and 'jumps' caused by environmental impacts to signals. There are several strategies to combine GNSS and INS. The simplest is the uncoupled solution, when both techniques provide their own independent solutions, and GNSS is used when available and to reset INS, whose solution is used at the periods when GNSS solution is unavailable. This approach is rarely used because it doesn't allow estimating sensor drifts, unlike the integration approaches. GNSS + INS integration approaches include (in order of complexity):

- **Loosely Coupled (LC)** Integration. In the LC approach, position and velocity obtained from GNSS solution are used as measurements in integration filtering procedure to estimate the INS errors. Thus, the positioning in this case is based on the corrected INS solution.
- **Tightly Coupled (TC)** integration. In the TC approach, raw GNSS pseudoranges and (optionally) Doppler observations are used along with INS measurements in a corresponding filter to estimate INS errors and GNSS receiver parameters.
- **Ultra-tight Coupled (UC)** integration. In the UC approach, also the signal processing of the receiver is implemented in integration with sensor data. This approach can be implemented on the firmware level of receivers or in software receivers.

In both LC and TC there are two configurations available: open-loop and closed-loop. Open loop means that the GNSS receiver pseudoranges are processed without any feedback of the

integration filter. In a closed-loop configuration, the feedback loop is implemented to correct raw measurements by the filter estimates.

In the context of the Performing Rail project, a Loosely Coupled (LC) integration strategy will be adopted, and it will be described in the following section.

6.1.1. Loosely coupling integration

A diagram summarizing the loosely coupled integration is shown on the following figure:

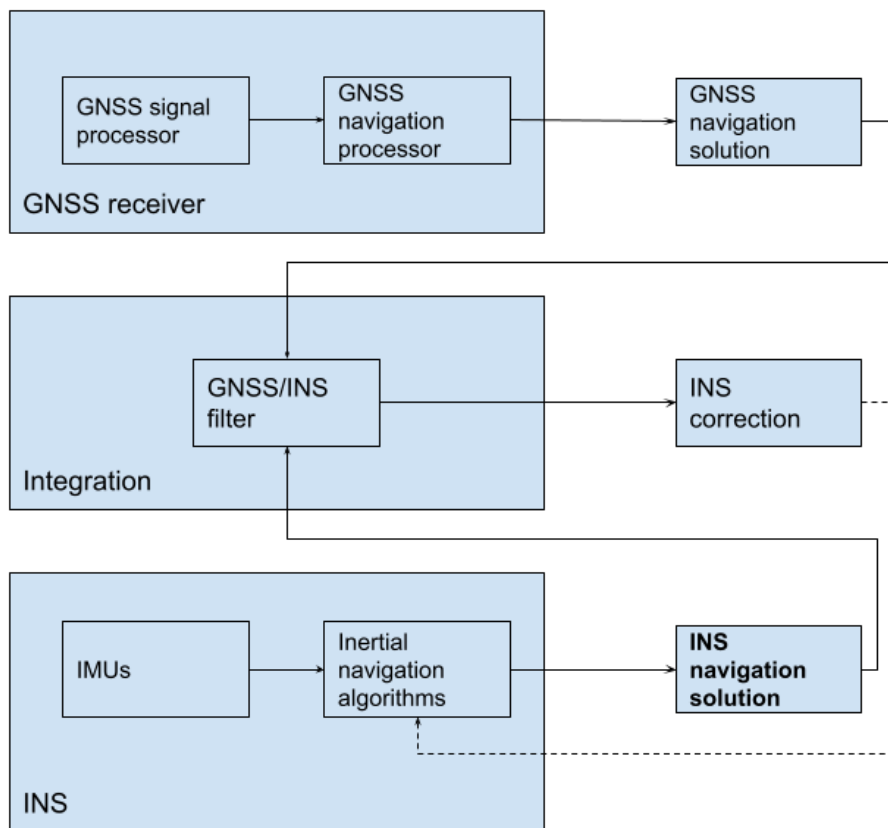

Figure 10. Diagram showing the Loosely coupling integration of GNSS and INS data

For the processing, a Kalman filter (KF) will be used. The result is the navigational solution: positions in the NED (North - East - Down) or geocentric frame corresponding to GNSS receiver output. To include the INS measurements, it is essential to know the attitude — orientation of the IMU device body frame (to which the measurements are referred) with respect to the NED frame

at every epoch of measurements. Such transformation may be generally parametrized by Euler angles as roll, pitch and yaw, direct cosine matrix (DCM) or by quaternions. The last approach is preferred as it is parametrized only by 4 numbers (instead of DCM 3×3 matrix), not affected by gimbal lock, and provides the linear formulation of orientation dynamics.

Kalman filter provides an estimation of parameters using a prediction stage (based on the process model equations) and a measurement update stage (by incorporating actual measurements from the sensors). The ‘weight’ relation between the current state and measurements is defined by so-called Kalman gain. There are many modifications of the KF more suitable for non-linear measurement models, but generally the filtering process is always presented by 3 steps: initialization, prediction, and correction (update). The last two steps repeat consecutively over the time.

Initialization	
\hat{x}_0, P_0	initial (a priori) state vector and covariance
Prediction	
$\hat{x}_{k k-1} = A_k \hat{x}_{k-1 k-1} + w_k$	state vector prediction
$P_{k k-1} = A_k P_{k-1 k-1} A_k^T + Q_k$	covariance prediction
Correction	
$K_k = P_{k k-1} H^T (H P_{k k-1} H^T + R_k)^{-1}$	Kalman Gain
$y_k = z_k - H_k \hat{x}_{k k-1}$	measurement pre-fit residual vector
$\hat{x}_{k k} = \hat{x}_{k k-1} + K_k (z_k - H_k \hat{x}_{k k-1})$	updated estimate
$P_{k k} = (I - K_k H_k) P_{k k-1}$	updated error covariance

In the equations above:

- $\hat{x}_{k|k-1}$ is a prediction of state vector for epoch k ,
- $\hat{x}_{k-1|k-1}$ is the estimate for the previous epoch or a priori values
- $P_{k|k-1}$ and $P_{k-1|k-1}$ are corresponding covariance matrices

- A_k is a state-transition model
- w_k is the process noise with variance matrix Q_k
- z_k is measurements vector
- H_k is observation matrix
- R_k is a measurement noise variance matrix.

So on each step corresponding to processed epochs one needs to execute prediction-correction computation.

In the case of IMU and loosely coupling integration, the parameter (state) vector to estimate is the following

$$x_k = [r_k^n \ v_k^n \ q_k \ \omega_{bias,k}^b \ a_{bias,k}^b]^T$$

where r_k^n, v_k^n are position and velocity vectors (n denotes the NED frame), q_k is quaternion which is interlinked to attitude φ_k (roll), θ_k (pitch), ψ_k (yaw) calculated from sensors data in a body frame (denoted as b superscript) and $\omega_{bias,k}^b, a_{bias,k}^b$ are the biases of corresponding sensors.

The measurements of the system (GNSS and IMU measurements) are collected in the measurement vector:

$$z_k = [r_{gnss,k}^n \ v_{gnss,k}^n \ \omega^b \ a^b \ h^b]$$

where a^b is the accelerometer's acceleration vector, ω^b gyroscope's angular velocity vector and h^b magnetometer strength vector.

Finally, the innovation vector (pre-fit residual vectors) are defined as:

$$y_k = [r_{ins,k}^n - r_{gnss,k}^n \ v_{ins,k}^n - v_{gnss,k}^n]$$

The integration may be performed in different reference frames, but in general the algorithm is the same and consists of three steps: initialization, INS position propagation and INS biases estimation using GNSS data. The last two steps are repeated along with time. INS measurements

are always in body-frame (denoted as b), and the GNSS solution is in the local or global terrestrial frame and can be easily translated to that is needed. So the INS solution always involves the transformation from body frame to the frame of interest (denote it as n). Also, it's necessary to add that the rate of the INS measurement in general is higher than GNSS output, therefore the INS biases are estimated on the GNSS output epochs and INS position propagation is performed within the intervals between them.

initialization (0 epoch) :

IMU measurements $\rightarrow \omega_0^b, \alpha_0^b$ (and β_0^b) \rightarrow Attitude \rightarrow body-to-NED transformation $\alpha_{b,0}^n$

GNSS solution $\rightarrow \alpha_0^n, \beta_0^n$

for every Δ -epoch > 0 **do**:

If GNSS epoch **do**:

estimate new $\{\alpha_{\Delta}^n, \beta_{\Delta}^n\}$

INS propagation:

$$\{\alpha_{\Delta}^n, \beta_{\Delta}^n\} = \{\alpha_{\Delta-1}^n, \beta_{\Delta-1}^n\}$$

$\alpha_{\Delta-1}^b, \beta_{\Delta-1}^b, \omega_{\Delta-1}^b, \alpha_{\Delta-1}^b$ (and $\beta_{\Delta-1}^b$) \rightarrow Attitude \rightarrow body-to-NED

transformation $\alpha_{b,\Delta-1}^n \rightarrow$ **calculate** $\alpha_{\Delta}^n, \beta_{\Delta}^n$

7. Train integrity

Train integrity Monitoring (TIM) systems for Moving Block and Virtual Coupling signalling need yet to overcome the challenge of checking integrity of trains⁷ with varying composition along their routes. Mostly this is the case for freight trains, whose compositions can vary over their whole journey depending on the origin/destination pairs requested by shipping companies for their goods [Borndörfer et al. 2013]. Large freight shipping companies might often request a freight block-train of 20 - 40 wagons, which in that case the freight train operator would operate as a

⁷ Not to be confused with “position integrity” discussed in previous sections. In this section, Train integrity refers to the fact that the train is integer (i.e. does not suffer from a train split)

direct freight train having a fixed composition. However, smaller shipping companies usually request only to transport 1 to 5 wagons, resulting in the need to couple those few wagons to a bigger freight block-train to limit transportation costs. In this latter case, the freight train would hence need to leave some wagons at their corresponding destination location and possibly pull additional wagons from that location as requested by other shipping companies. The freight train shall hence be disassembled and/or assembled at classification yards every time a wagon reaches its destination, thereby changing its composition (therefore its length) until all the transported goods are delivered to the requested location.

Passenger trains could also vary their composition, for instance when splitting into two diverging services, usually at strategic stations in proximity of diverging branches of the railway network. Passenger trains can also be coupled to form longer train sets going towards stations attracting high level of passenger demand (e.g. big cities, or industrial areas). Also, passenger trains coming to an unforeseen halt because of a rolling stock breakdown will usually be coupled to a rescue train to move the broken train to the closer station or shunting yard. The rescue train and the broken train will hence form a new train with a different composition, whose integrity shall be monitored as well. Whilst the integrity of a train with fixed composition can be easily monitored by checking that the length of the train does not change over its route, the same cannot be easily done instead for a train with changing composition, as one of those described above. The main limitation is that there is no clear process on how the change in train length can be reported to the EVC and the RBC in the ERTMS/ETCS signalling. Possible options are for instance that the responsible train driver might manually re-insert the updated train length every time the train changes composition, by switching each time the train to an ETCS state of “Start of Mission”. However, iterative manual data insertion could raise safety risks in case of erroneous reporting or system malfunction. A potential alternative would be instead to have algorithms which could automatically compute, indicate, and validate the correct train length to the onboard ETCS components and RBC every time the train composition changes. An automatic algorithm could also be directly connected to train onboard systems to receive warnings and or information about potential system faults which could affect train integrity. Either for a manual or an automatic update of train composition data, a validation procedure is deemed essential to ensure that the train length acknowledged by the onboard and trackside ETCS components are correct. Such a validation might therefore require an exchange of information on the train length between trackside and onboard train components and the GNSS system before a train could actually start a mission after that its composition has changed.



8. Railway and location simulators

This section contains the details of the Railway and location simulators, that will be implemented and developed during the execution of the Performing Rail project, in order to simulate the performance of the GNSS system under the occurrence of the various feared events discussed in previous sections.

As such, the following sections include details on the simulator architecture as well as interface definition between the signalling and GNSS components.

8.1. Architecture

The railway location system simulator will be composed by 2 different entities that will communicate with each other:

- Railway signalling simulator (RSS), which will report the actual train trajectory represented as a series of locations (longitude, latitude, height) associated with their calling times. The RSS will also generate a special events file that highlights the existence of tunnels, bridges, forests, and anything else that would affect the GNSS signal.
- GNSS location simulator (GLS), which will accept position and epoch as input, generate synthetic GNSS pseudorange and carrier phases and forward them to the positioning engine to generate a position estimate that will be fed back to RSS.

A system-level overview of the architecture is shown in the following figure. RSS will send a position to GLS via TCP protocol and in CSV format (described below) and will receive back a position, also via TCP protocol and in CSV format. Within the GNSS location simulator, there are 2 components: **argos** and **rifft**, that are part of Rokubun core software for GNSS data processing. While **argos** simulates ranges given an input position and a certain scenario (defined by GNSS orbits and clocks as well atmospheric conditions), **rifft** is the actual position engine that processes the GNSS ranges in order to deliver a position. The configuration of these two executables is performed via INI configuration files.

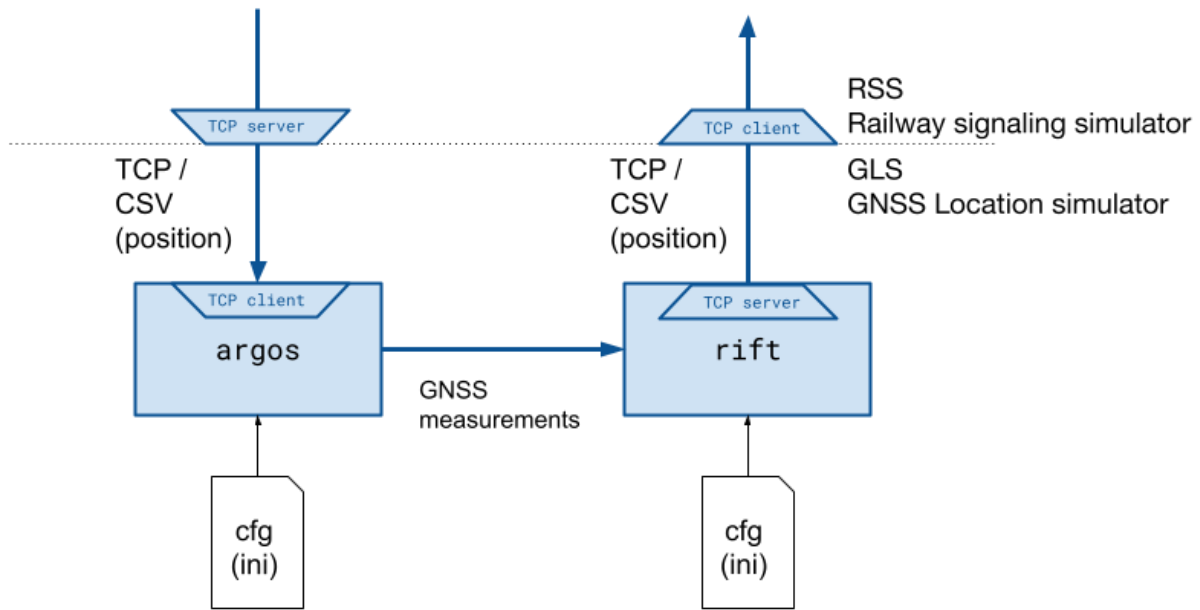

Figure 11. Block diagram of interfaces between Rokubun’s GNSS simulator and the railway signalling simulator

8.2. Interface

The railway signalling simulator (RSS) will deliver to the GNSS Simulator (GLS) the position of one or various receivers in the following CSV format:

```
UTCdate,UTctime,latitude(deg),longitude(deg),height(m),rx_name
2021-03-01,09:40:00.000,41.402434220,2.194859688,53.9370,RX1
2021-03-01,09:40:01.000,41.402434220,2.194859688,53.9370,RX1
2021-03-01,09:40:02.000,41.402546681,2.194651718,45.8068,RX1
2021-03-01,09:40:03.000,41.402546681,2.194651718,45.8068,RX1
2021-03-01,09:40:04.000,41.402524887,2.194684055,49.9446,RX1
2021-03-01,09:40:05.000,41.402524887,2.194684055,49.9446,RX1
2021-03-01,09:40:06.000,41.402512219,2.194679861,51.1243,RX1
```

Each of the fields shown in the file are defined as follows:

- UTCdate and UTctime represent the epoch information, expressed in date and time (UTC timescale).
- latitude (deg) is the WGS84 latitude, expressed in degrees
- longitude (deg) is the WGS84 longitude expressed in degrees
- height (m) is the WGS84 ellipsoidal height expressed in meters

- `rx_name` is the name of the receiver, this will allow simulating multiple receivers, which will be used for the train split (break) simulation.

This format will be used for both inbound and outbound format description for both simulators. This format could eventually be used to add:

- Acceleration and gyroscope information to simulate the measurements delivered by inertial measurement units (IMU) units
- Event information that could be used to mark the starting point of e.g., foliage, tunnel (alternatively, an external file could be used for this purpose).



Figure 12. Demonstration of the simulation phase of the GLS simulator. White circles are input values provided by RSS and blue dots are the corresponding simulation delivered by GLS. This case corresponds to the ideal case, without no feared events.

8.3. Signalling simulator

The Railway Signalling Simulator (RSS) is constituted by the **Birmingham Railway Simulation Suite (BRaSS)**, a microscopic railway simulator developed by the Birmingham Centre for Railway Research and Education (BCRRE). It can simulate all the basic functions of railway control and management. Through a number of panels, the simulator can represent realistic scenarios by configuring multiple parameters, including the traffic setup, vehicle type and specification, infrastructure data, and interlocking arrangements.

BRaSS has a component-based architecture, as shown in the following figure. Each of the components in the system performs an independent set of functions. Components are divided into three main groups:

- Static – This data is described as static because it does not change during the simulation process.
- Dynamic – things that change state of things: i.e., Interlocking changes state of signalling, traffic changes state of trains and clock changes state of time.
- Actors – Things that represent human behaviour (that can be replaced with real people interfaces).

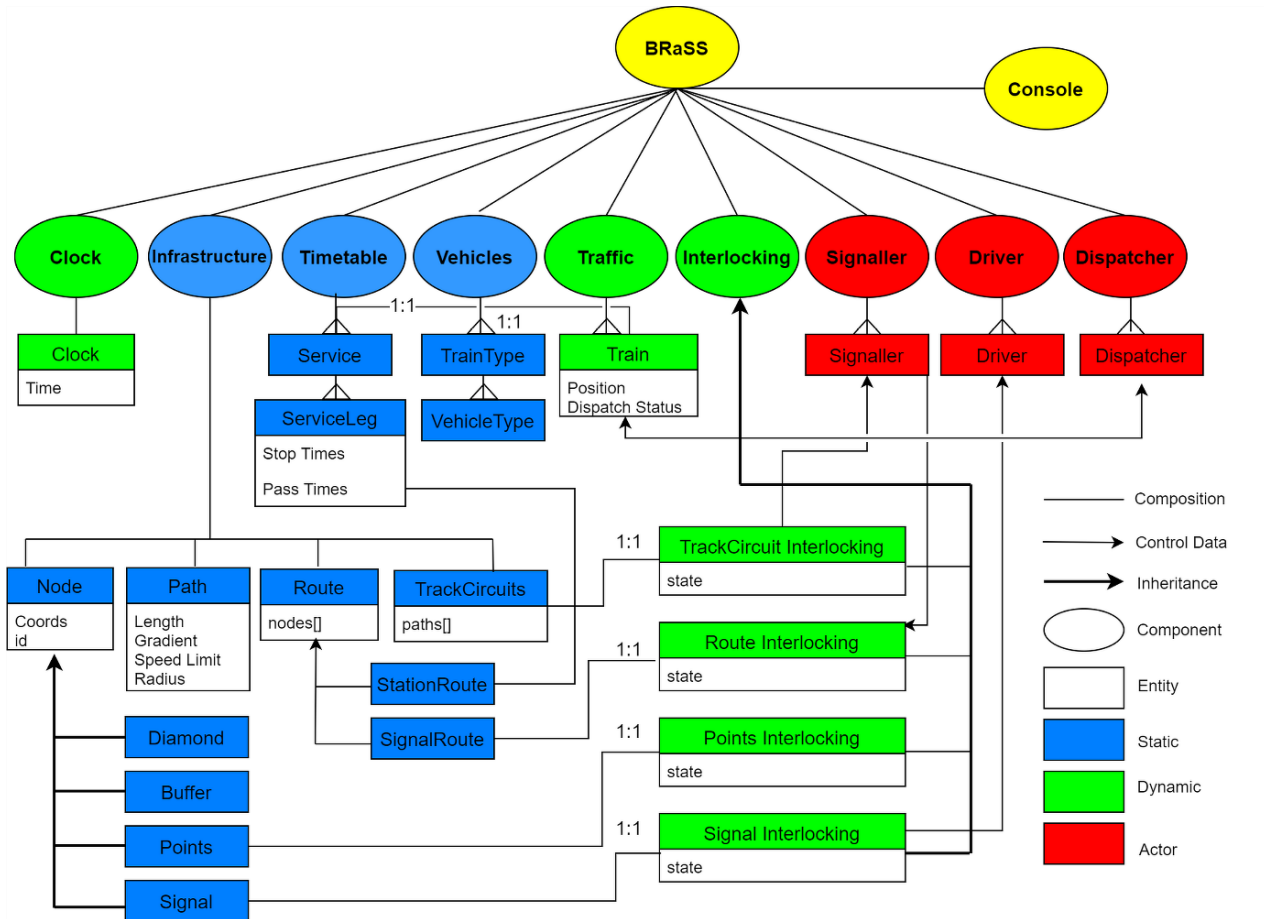

Figure 13. BRaSS main components and entities

8.4. Continuous Integration and Deployment

The implementations to be performed will be done in a Continuous Integration and Deployment fashion based on Docker containers that will expose a TCP port in order to communicate with the external world. This will ensure:

- Each development party will be able to develop in their own environment without affecting each other.
- A traceable system freeze (to fix dependencies and software to be installed in the Docker image)

The development steps to be followed to achieve (for the testing activities) a fully operational testing simulation will be based on the following “deliveries”

1. Dummy GLS system that will consist in echoing the incoming input from the RSS. This will

- help settle the interfaces between the two simulators
- 2. Replacement of the echoing functionality with the actual GNSS simulation. A “clean” simulation without events (foliage, multipath, ...) will be exercised in this step
- 3. Addition of feared events in the simulation process.

8.5. Train split detection

A train split detection algorithm consists in the monitoring of the position between two GNSS receivers located at the front and back of the train. If the distance between these two receivers exceeds a certain threshold, then a warning will be issued. A summary of the model is shown in the sketch below:

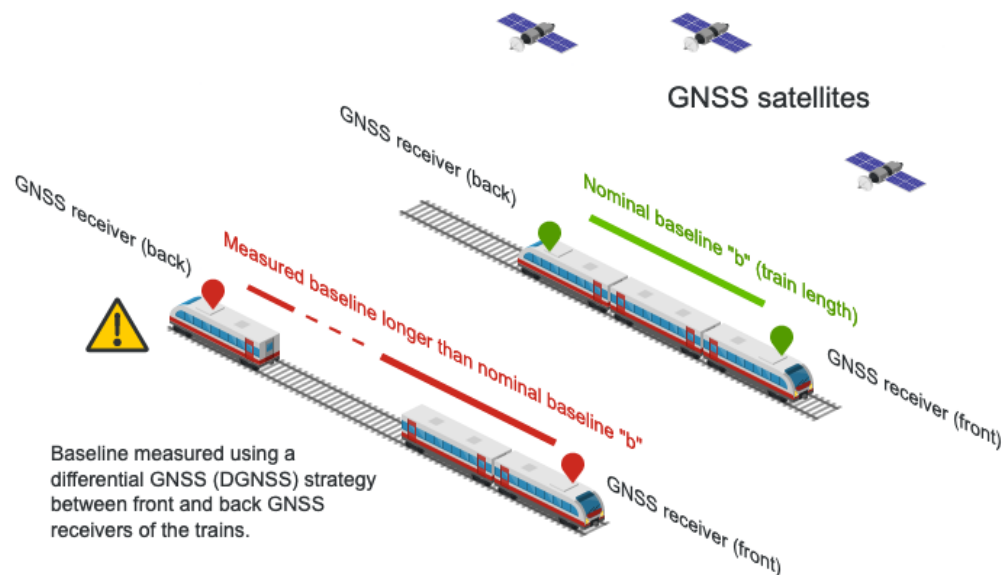

Figure 14. Train split detection concept

Therefore, the scenario of this feared event will require a multi-receiver setup. The GNSS observables of each receiver will be simulated using a constant baseline, and this baseline will be extended in the event of a train split. The GLS will receive from the signalling simulator positions from both the front and rear receivers via the CSV format specified earlier in this document. The tool **argos** will then simulate the GNSS measurements for both receivers and feed them to the positioning engine (**rifit**), which will then compute the position estimates for both receivers. Upon the solution is computed, a simple script will check the distance between the solutions and

if they exceed a certain threshold, an issue to the signalling system will be issued.

The setup of the train split script will only consist in the definition of the threshold that defines the baseline distance (i.e., train length).

Note that the applicability of this technique is only limited to the case where the block does not change during operations. If the number of convoys change, operations must ensure that there is a GNSS receiver at the back of the train. An alternative would be to have a GNSS receiver at each car of the train, but this requirement may or may not be fulfilled by the manufacturer.

The ETCS System specification depends on train length being determined once, at Start of Mission. This could be automatically or manually entered by the Driver. Then the train must report Train Integrity, and also the Safe Train Length, `L_TRAININT` in Train Position Reports. `L_TRAININT` represents the length from the current front of the train at the time of the Train Position Report, to the location of the rear of the train at the time at which Train Integrity was last confirmed.

If there is continuous determination of train length, for example using GNSS, then the train length will vary. However, there is no provision within the ETCS System for train length to vary during operation. The continuously monitored train length can be used to determine Train Integrity, rather than be directly reported to the ETCS On-Board.

One possibility to dynamically know the train length would be to use the GNSS receivers onboard to measure the initial train length (when the train is stopped at a station) and use it as a reference to be used during the mission: the baseline between front and back GNSS receivers would determine the train length (baseline) and compare it with the one measured at start of mission. Warnings would be then raised if the two distances differ above a certain threshold.

8.5.1. TIM algorithm requirements

Based on the description provided in the previous sections, Train Integrity Monitoring could rely on an algorithm which automatically computes the train length every time its composition changes, while checking that this length does not change during service until other coupling/decoupling procedures are performed. The TIM algorithm shall hence satisfy the following requirements:

Req ID	Description
TIM-01	The algorithm shall reliably and accurately compute the length of a train operating with a fixed composition between any given origin and destination locations. Computation times shall be suitable to the real-time nature of railway operations.
TIM-02	<p>The algorithm shall (re)compute and validate the train length any time its composition changes.</p> <p>a) Possible changes in passenger train composition can occur:</p> <ul style="list-style-type: none"> i) At stations in close proximity of merging junctions, any time two services are joined into a single longer serving destinations with a high level of passenger demand. ii) At stations in close proximity of diverging junctions, any time one service is split into two shorter ones, serving destinations located on two diverging branches of the railway network. iii) At any track location on the network whenever a rescue train will be coupled to a train stranded on the tracks after a rolling stock breakdown. <p>b) Possible changes in freight train composition can occur at:</p> <ul style="list-style-type: none"> i) Classification yards of freight origin/destination locations where wagons need to be decoupled (because reaching the requested destination) or additional wagons need to be coupled (because being picked up from the requested origin).
TIM-03	The algorithm shall (re)compute and validate the train length any time a train crosses the location of a safety-critical infrastructure element, such as point switches and level crossings
TIM-04	The train length shall be computed, provided to and recorded into the essential onboard (e.g., EVC) and trackside (i.e. RBC) signalling components.
TIM-05	The computed train length can be provided to the responsible train driver at any new train composition update, in case the train requires manual initialization of the train data into the onboard and trackside signalling equipment.
TIM-06	Alternatively, the computed train length can, at any new train composition update, be provided to and automatically inserted into the onboard and trackside signalling equipment, in case that equipment allows automatic initialization of train data.

TIM-07	The computed train length shall be inserted in the onboard and trackside signalling component before a train starts a mission.
TIM-08	Before a train can start a mission, the algorithm shall validate the train length initialized into the onboard and trackside signalling components, by means of combined data interactions and cross-checks with the GNSS system and all the relevant train- and trackside signalling equipment.
TIM-09	The algorithm shall compute and validate the train length both on conventional tracks and shunting tracks to ensure operation safety during ordinary as well as shunting procedures.
TIM-10	In case the train length computed by the algorithm is not or only partially validated, a corresponding warning/error notification shall be sent to the onboard and trackside signalling equipment.
TIM-11	The algorithm shall interact with onboard train control components (e.g., the engine, the braking system, couplers) to acknowledge system warnings and/or malfunctioning which could somehow affect train integrity.
TIM-12	In case system warnings or malfunctioning are acknowledged by the algorithm during a train mission, a corresponding warning/error notification shall be sent to the onboard and trackside signalling equipment.
TIM-13	Algorithm developers shall analyse and assess a suitable and flexible configuration of GNSS receivers on board, including the option of GNSS receivers on any car versus equipping GNSS receivers only on the front and back cars.



9. Conclusions

This document discussed several aspects in which GNSS can contribute to railway operations. In particular to the reduction of equipment and trackside components. As shown in the introductory part of the document, the European Commission as well as other European Agencies have put efforts in exploring the applicability of GNSS in a railway context.

Being the provision of location a safety critical component, there are still several issues to be addressed before committing GNSS as the principal provider of position in a railway environment, especially for the provision of Service Level 3 of ERTMS (i.e., support for moving block and virtual coupling). In particular, provision of position should be completed with provision of integrity, continuity and availability.

The deliverable includes also details on the tool to exercise potential GNSS receiver systems in a signalling simulator. The purpose of the simulation is to test the whole GNSS processing chain (a) pseudorange generation by a software GNSS receiver (i.e., range simulator) as well as (b) processing engine to obtain the position from the observed pseudoranges (in this case synthesized ranges). This processing flow allows certain flexibility to simulate and test the impact of the several feared events discussed also in the document.

10. References

- [ASTRAIL, 2018a] ASTRail, “D1.2 – Local GNSS Effects”, 2018, Available at <http://www.astrail.eu/download.aspx?id=e1480e99-8c87-4d4a-843a-658d00f00a5c>
- [ASTRAIL, 2018b] ASTRail. “D1.3 - The ERTMS hazards associated with GNSS faults”, 2018, Available at <http://www.astrail.eu/download.aspx?id=613811b7-8869-4161-ae8c-9b6de47dde32>
- [Bauer et al., 2015] Bauer, S., Streiter, R., & Wanielik, G. (2015, July). Non-line-of-sight mitigation for reliable urban GNSS vehicle localization using a particle filter. In 2015 18th International Conference on Information Fusion (Fusion) (pp. 1664-1671). IEEE.
- [Beugin et al., 2018] Beugin J., Legrand C., Marais J., Berbineau M., El-Koursi E.-M. “ Safety Appraisal of Localization Systems Based on GNSS Used in Train Spacing Control,” IEEE-Access, vol.6(1): pp 9898 - 9916, 2018, DOI: 10.1109/ACCESS.2018.2807127
- [Bilich et al., 2008] Bilich, A., Larson, K. M., & Axelrad, P. (2008). Modeling GPS phase multipath with SNR: Case study from the Salar de Uyuni, Boliva. Journal of Geophysical Research: Solid Earth, 113(B4).
- [Borndörfer et al. 2013] Borndörfer R. , Fügenschuh A. , Klug T. , Schang T. , Schlechte T. , Schüllendorf H., The Freight Train routing problem, ZIB Report - Konrad-Zuse-Zentrum für Informationstechnik, Berlin, 2013.
- [De Angelis et al 2016] De Angelis, Guido, Antonio Moschitta, and Paolo Carbone. "Positioning techniques in indoor environments based on stochastic modeling of UWB round-trip-time measurements." IEEE Transactions on Intelligent Transportation Systems 17.8 (2016): 2272-2281.
- [EU, 2016] Regulation TSI CCS (EU) 2016/919, “Technical Specification for Interoperability relating to the 'Control-Command and Signalling' subsystems of the rail system in the European Union,” European Commission regulation, 27th May 2016. <https://eur-lex.europa.eu/legal-content/en/ALL/?uri=CELEX%3A32016R0919>
- [EU, 2013] Regulation (EU) 402/2013, “Common Safety Method for risk evaluation and assessment and repealing Regulation (EC)352/2009,” Commission implementing regulation, 30th April 2013. Available at: <https://eur-lex.europa.eu/legal-content/EN/TXT/?uri=CELEX%3A32013R0402>
- [GATE4RAIL, 2019] GNSS Automated Virtualized Test Environment for RAIL (GATE4Rail)

“Deliverable 2.2 – Railway and GNSS Test Cases”, 2019, Available at:

<https://gate4rail.eu/download.aspx?id=10cd681c-979f-42db-b2b7-6fb56406c578>

[Gentner et al 2020] Gentner, C., Ulmschneider, M., Kuehner, I., & Dammann, A. (2020, April). Wifi-rtt indoor positioning. In *2020 IEEE/ION Position, Location and Navigation Symposium (PLANS)* (pp. 1029-1035). IEEE.

[Gerlach and Rahmig, 2009] K. Gerlach and C. Rahmig, "Multi-hypothesis based map-matching algorithm for precise train positioning," *2009 12th International Conference on Information Fusion*, 2009, pp. 1363-1369.

[GRAIL, 2007], GRAILS project. “Improving Accuracy and Integrity in Rail Applications through the Integration of GNSS with a Digital Route Map“. Annex E_GRAIL-WP3-RSB-TEC-12-v10

[Lauer and Stein, 2015] M. Lauer and D. Stein, "A Train Localization Algorithm for Train Protection Systems of the Future," in *IEEE Transactions on Intelligent Transportation Systems*, vol. 16, no. 2, pp. 970-979, April 2015, doi: 10.1109/TITS.2014.2345498

[Marais et al, 2017] J. Marais, J. Beugin, and M. Berbineau, “A survey of GNSSbased research and developments for the european railway signaling,” *IEEE Transactions on Intelligent Transportation Systems*, vol. 18, no. 10, pp. 2602–2618, 2017-10. [Online]. Available at: <http://ieeexplore.ieee.org/document/7857080/>

[NGTS, 2015] Next Generation of Train Control Systems, “D7.4 Engineering rules specification”, 2015, Available at: https://ngtc.eu/wp-content/uploads/2017/05/D7.4_Engineering_rules_specification.pdf

[Obst et al., 2013] Obst, M., & Wanielik, G. (2013, June). Probabilistic non-line-of-sight detection in reliable urban GNSS vehicle localization based on an empirical sensor model. In *2013 IEEE Intelligent Vehicles Symposium (IV)* (pp. 363-368). IEEE.

[Pages-Zamora et al 2002] Pages-Zamora, Alba, Josep Vidal, and Dana H. Brooks. "Closed-form solution for positioning based on angle of arrival measurements." *The 13th IEEE international symposium on personal, indoor and mobile radio communications*. Vol. 4. IEEE, 2002.

[Solin et al 2018] Solin, A., Kok, M., Wahlström, N., Schön, T. B., & Särkkä, S. (2018). Modeling and interpolation of the ambient magnetic field by Gaussian processes. *IEEE Transactions on robotics*, 34(4), 1112-1127.

[Spilker et al. (eds) 1996] Spilker Jr, J. J., Axelrad, P., Parkinson, B. W., & Enge, P. (Eds.). (1996). *Global positioning system: theory and applications, volume II*. American Institute of



Aeronautics and Astronautics.

[STARS 2018a] STARS project, "D4.3 Railway environment characterization", 2018, available at [http://www.stars-rail.eu/wp-content/uploads/2019/08/D4.3 Railway environment characterization.pdf](http://www.stars-rail.eu/wp-content/uploads/2019/08/D4.3_Railway_environment_characterization.pdf)

[STARS 2018b] STARS project, "D5.1 State of the art of EGNSS projects for the rail application", 2018, available at <http://www.stars-rail.eu/wp-content/uploads/2017/05/D5.1-State-of-the-art-of-EGNSS-system-for-the-rail-application-updated....pdf>

[Torrieri, 1984] Torrieri, Don J. "Statistical theory of passive location systems." *IEEE transactions on Aerospace and Electronic Systems* 2 (1984): 183-198.

[UCP-Rail 2020] User Consultation Platform 2020 – Minutes of Meeting of the Rail Market Segment Panel – <https://www.euspa.europa.eu/euspace-applications/euspace-users/user-consultation-platform-20>

[Walter et al 1999] Walter, Todd, Andrew Hansen, and Per Enge. "Validation of the WAAS MOPS integrity equation." In *Proceedings of the 55th Annual Meeting of The Institute of Navigation (1999)*, pp. 217-226. 1999.



A. Appendix A: GNSS projects related to railway signalling

The tables included in this Appendix present EU projects on the last two decades and their outcomes aiming at introducing GNSS in railway safety applications. Railway Control-Command and Signalling systems (CCS) dedicated to the safe train movement management are especially targeted. How GNSS can be integrated in ERTMS/ETCS, the European CCS, are highlighted.

- Table 1 presents past EU projects under DG XIII, FP5, FP6 and FP7 programmes.
- Table 2 presents past EU projects supported by the EUSPA⁸ in FP6 and FP7 programmes.
- Table 3 presents EU projects supported by the EUSPA in H2020 programme.
- Table 4 presents EU projects supported by Shif2Rail.
- Table 5 presents EU projects supported by ESA⁹.
- Table 6 presents new EGNSS mission and services and R&D strategy for rail. They are H2020 projects supported by DG DEFIS (Defence, Industry and Space).

⁸ EUSPA (ex-GSA) = EU Agency for the Space Programme. It manages Europe's GNSS (EGNSS) programmes EGNOS and Galileo, in particular the roadmap for EGNSS in rail signalling systems available on <https://www.gsa.europa.eu/sites/default/files/rail-roadmap2018.pdf>

⁹ ESA = European Space Agency. Railway-related projects are presented on <https://space4rail.esa.int>



Table 1. EU projects under DG XIII, FP5, FP6 and FP7 programmes

Project name	Period	Some objectives and developed solution
APOLO	1998-2001	The objective of this project was to demonstrate that a GNSS (GPS + EGNOS) and inertial navigation-based train position locator is feasible for railway safety applications <ul style="list-style-type: none"> • GPS receiver in various operating modes (standalone, DGPS, EGNOS) + inertial navigation sensors
LOCOPROL / LOCOLOC	2001-2005	This project focuses on low-density traffic lines and ERTMS/ETCS. Gembloux (Belgium) and Nice-Digne (France) test lines were used. PREDISSAT tool is developed to predict satellite availability based on image processing knowledge of the environment. <ul style="list-style-type: none"> • GPS receiver + EGNOS + balise + odometer + use of redundant pairs of satellites to compute merged confidence intervals
Gaderos	2003-2004	This project focuses on low-density traffic lines and on the integration viability with an ERTMS/ETCS simulation platform. The Virtual Balise concept is introduced. <ul style="list-style-type: none"> • GPS receiver + EGNOS (some configurations with virtual balise database + some other hybridizing GNSS with odometer / angular rate sensor / accelerometer / digital map)
INTEGRAIL	2001-2004	This project aims to create a holistic, coherent information system, integrating the major railway sub-systems, in order to achieve higher levels of performance. For the localisation, it opens the way for profitable use of the EGNOS signal in safety-critical railway traffic management and control. <ul style="list-style-type: none"> • GPS receiver + localisation integrity information offered by EGNOS + other location/velocity sensor data within a hybridized positioning solution (train odometer + angular rate sensor + accelerometer + digital route database)
GIRASOLE	2005-2007	This project aims to develop a GNSS-based localisation prototype for railways using Galileo and EGNOS Safety-of-Life services. <ul style="list-style-type: none"> • Multi-constellation GNSS receiver (GPS + GLONASS + Galileo)
EATS	2012-2016	This project has the objective to address these two situations: <ol style="list-style-type: none"> 1. Propose an innovative lab with tools providing a model of the on-board ERTMS system and including the dynamic behaviour of the air-gap communication and fault injection for the safety assessment. 2. Propose a novel positioning system based on the combination of different techniques proved useful for other industrial sectors. <ul style="list-style-type: none"> • GNSS receiver + GSM-R and UMTS localisation
NGTC	2013-2016	The main scope of this project is to analyse the commonality and differences of required functionality for mainline and urban lines and develop the convergence of both ETCS and CBTC systems. The NGTC WP7 focused on application of the satellite positioning



		functionality in the frame of ERTMS/ETCS (virtual balise concept). Activities have been based on the previous results of the UNISIG Satellite Positioning Workgroup.
--	--	--

Table 2. EU projects supported by the EUSPA in FP6 and FP7 programmes		
Project name	Period	Some objectives and developed solution
GRAIL	2005-2008	<p>This project aims to prove the feasibility of introducing a GNSS-based system in different integration levels of ERTMS/ETCS by means of theoretical studies (safety analysis, some system prototypes) and demonstrations.</p> <ul style="list-style-type: none"> • Different functional and technical concepts have been presented: enhanced train odometry (GNSS receiver + odometer + IMU), GNSS for fixed balise markers (virtual balise).
GRAIL-2	2010-2012	<p>Similarly to GRAIL, GRAIL-2 aims at a smooth integration of GNSS into rail control and command applications and particularly within ETCS by getting a final product (enhanced odometry) close to the market.</p> <ul style="list-style-type: none"> • Architecture with 2 channels built according to reactive fail-safe principle (cf. EN 50129)
GaLoROI	2012-2014	<p>This project seeks to develop a new safety application-relevant localisation system that combines satellite positioning data with satellite-independent data, here provided by an Eddy Current sensor, in order to provide a robustness train position on low density railway lines.</p> <ul style="list-style-type: none"> • Architecture with 2 channels built according to the composite fail-safe principle (cf. EN 50129), dependability and safety performance analyses
SATLOC	2012-2014	<p>In this project, an innovative hybrid solution has been proposed that combines experimental knowledge of the masking obstacles with a GNSS signal simulator. The interest of the approach is to reproduce a trajectory and its associated reception conditions with obscurity. Then a scenario can be repeated or replayed with many different parameters without the need to go back in operation onto the railway line.</p> <ul style="list-style-type: none"> • GNSS receiver + EGNOS + odometer, demonstration of EGNOS and GALILEO use on a Romanian railway line, validation and certification process based on GNSS



Table 3. EU projects supported by the EUSPA in H2020 programme

Project name	Period	Some objectives and developed solution
ERSAT-EAV	2015-2017	The main project objective is to verify the suitability of EGNSS for safety railway application for low density lines. An EGNSS-based system is developed and tested on a pilot line of 50 km in Sardinia/Italy (Cagliari/San Gavino line). This line is equipped with multi constellation receivers, with solutions for GNSS-denied area and local area augmentation network enhancing EGNOS. This line will serve as a reference in Italy for the future standardisation and certification processes.
RHINOS	2016-2017	This project applies aviation-related localisation integrity concepts of GNSS into a railway context to allow safety-critical operations. High-integrity concepts are developed for trains to protect the estimated train position. <ul style="list-style-type: none"> ● Architecture combining SBAS/Local Differential GNSS + local monitoring via ARAIM-separation method
STARS	2016-2018	This project aims at characterising the rail environment via field tests and developing an approach to predict the achievable GNSS performances in a railway environment. This is needed for the use of GNSS in safety-critical applications, especially in ERTMS. <ul style="list-style-type: none"> ● Large-scale measurement campaigns in Switzerland, Italy, and the Czech Republic
ERSAT-GGC	2017-2019	This project aims to contribute to the railway certification process to enable the adoption of EGNSS for Virtual Balises. <ul style="list-style-type: none"> ● Functional architecture + test specifications + certification process with related methodology and toolset for classification of track area suitability for enabling VB implementation.
SIA	2018-2021	This project will define end-to-end EGNSS services providing prognostic information on the health status of the railway's most demanding assets in terms of maintenance costs (wheel, rail, pantograph and catenary). <ul style="list-style-type: none"> ● Use of EGNOS and Galileo multi-frequency, multi-constellation signals + digital map + filter
HELMET	2020-2022	The HELMET project intends to exploit the synergies between rail and road. The main objective is to develop innovative EGNSS applications capable of impacting eco-friendly and green transportations modes (connected and driverless cars, train signalling, UAV for surveillance of roads and railways). This project follows the RHINOS project. <ul style="list-style-type: none"> ● Multi-constellations, multi-frequencies, and multi-sensors (sensor fusion with Kalman filter) + augmentations (SBAS, GPS & Galileo ground services) + avionics ARAIM concept for FDE, tests in Italy on the l'Aquila town test bed of EMERGE
CLUG	2020-2022	This project aims at providing a continuous and accurate train localisation that could be integrated in the future ERTMS. The project will address different concepts such as digital map definition, fusion algorithms, the localisation integrity concept and the



		certification. A special action is devoted to EGNOS augmentation as performance based on DFMC service EGNOS v3.2 is not sufficient for railway needs, which needs a different localisation integrity concept coming from augmentation systems. <ul style="list-style-type: none"> • Integration of GNSS with other sensors (such as IMU, tachometer, digital map) to remove balises in ERTMS Level 3
RAILGAP	2021-2023	This project focuses on developing innovative High Accuracy, High Precision Ground Truth and Digital Maps, essential elements of an EGNSS train positioning system and a V&V Environment.

Table 4. EU projects supported by Shif2Rail

Project name	Period	Some objectives and developed solution
X2Rail-2 (Call for member S2R project)	2017-2020	Work Package 3 of this project investigated 2 possible solutions for a Fail-Safe Train Positioning System including GNSS. System and architectural requirements were given in the following work streams: <ul style="list-style-type: none"> • Stream 1 dedicated to a solution based on the virtual balise concept • Stream 2 for the use of additional sensors to complement a standalone GNSS-based solution, including the development of algorithms for sensor fusion
X2Rail-5 (CFM project)	2020-2022	Work Packages 5, 6 and 7 of this project will upgrade works performed in X2Rail-2 until providing 2 demonstrators and a roadmap for the integration of the FTPS using GNSS into the TSI (Technical Specification for Interoperability) CCS (European regulation).
ASTRAIL (open call)	2017-2019	This project aims to improve technologies for railway signalling and automation by investigating new applications and solutions taken from other domains such as avionics or automotive. In particular, this project leverages the expertise of the aeronautic sector on GNSS technology to define an efficient train localisation system with minimum achievable performances. The main formal modelling and verification languages and tools used in industrial railway applications are assessed with their capabilities for analysing the safety and operational performances. The implementation of the railway moving block principle with a new localisation system is investigated.
GATE4RAIL (open call)	2018-2021	This project develops a geo-distributed simulation and verification platform, remotely connecting existing European ERTMS/ETCS laboratories and GNSS centres of excellence, to evaluate GNSS performances in the railway environment. Moreover, it aims at defining the methodology and tools for automated update of test environments, continuous integration, their automated repetition and evaluation through Model-Based System Engineering (MBSE) philosophy.



Table 5. EU projects supported by ESA

Project name	Period	Some objectives and developed solution
ECORAIL	2001-2005	This project aims to demonstrate the feasibility and benefits of GNSS in combination with the ERTMS/ETCS. Automatic level-crossing control is investigated. <ul style="list-style-type: none"> • GPS receiver + EGNOS + Train sensors + GIS (Geographic Information System) + data fusion computer
RUNE	2001-2006	EGNOS augmentation system is used as part of an integrated solution to improve the train driver’s situational awareness. <ul style="list-style-type: none"> • GPS receiver + EGNOS + odometer + IMU, the virtual balise concept is used.
SafeRail/LeCross	2013-2014	These projects aim to provide a cost-effective solution using Satellite Navigation and Satellite Communication technology, allowing railway operators to accelerate their level crossing upgrade programme.
IRISS	2012-2014	The key target users for this project are Train Operating Companies for whom multiple applications of satellite-based communications and navigation services will be identified.
3InSat	2012-2014	This project aims at developing and validating a new satellite-based platform to be integrated into ERTMS system and based on the virtual balise concept. This satellite supported solution is not yet available on the market because of the very challenging safety requirements (SIL 4 requirement) that a railway signalling system shall comply with. A validation campaign is planned on a pilot test line in Sardinia/Italy that also implements virtual fixed block signalling sections (Cagliari/San Gavino line). <ul style="list-style-type: none"> • GNSS receiver (EGNOS + multi-constellations: GPS + GLONASS + Galileo) + SIL 4 odometer + IMU + digital map stored on-board + specific track area augmentation and localisation integrity monitoring network to be installed along the railway track
RailSafe	2016-2018	This project aims at exploring how different safety-enabled GNSS Augmentation techniques (such as SBAS, GBAS or RAIM) can be used or adapted to be used in the railway domain, thus fostering the adoption of GNSS technologies in a wider range of applications and contributing to the creation of new business opportunities, as an input to a GNSS roadmap for railways.
SBS-Rails-2.1	Start in 2018	The project purpose consists of the design, development and testing (both in the laboratory and in the field on the Pinerolo-Sangone Line-Italy) of ERTMS Regional L2 solution. This is based both on the satellite localisation of the train and on the wayside-train communications (IP-based protocols and services of the public networks using the MLCP-Multi Link Communication Platform- developed in the SAT4Train environment).



Sim4Rail	Start in 2018	<p>This project aims to specify and develop highly controllable laboratory tools for a test bench able to simulate real operating conditions, even those that are deteriorated and hard to repeat by testing in the field. It supports the development of PNT technologies for railway signalling applications that also operate when there are interferences or problems on the GNSS signals.</p> <ul style="list-style-type: none"> The specification will be first defined as required by the railway CENELEC guidelines. The second step of the project will focus on developing software tools and relevant verification, validation and integration activities.
STEMS	2018-2019	The project objective is to study the suitability of the current generation of SBAS (Satellite-Based Augmentation Systems) for use in the evolution of ERTMS with virtual balise detection using GNSS, confirming the feasibility of current system safety allocations.
CAPRESE	2018-2019	The objective of the activity is to study GNSS carrier phase integrity techniques (compared to GNSS code-based integrity) for critical railway applications (such as ERTMS) with virtual balise detection.
3TIMS	Start in 2019	<p>One essential element for implementing ERTMS/ETCS L3 is the continuous monitoring of the completeness of a train without the need of trackside equipment. This project aims at investing GNSS technologies for implementing a Train Integrity Monitoring System (TIMS).</p> <ul style="list-style-type: none"> GNSS receiver at train head and tail + IMU + Brake Pipe monitoring + M2M (Machine to Machine) / 5G radio link.

Table 6. New EGNSS mission and services and R&D strategy for rail: H2020 projects supported by DG DEFIS

Project name	Period	Objectives
EGNSS-R	Start in 2020	This project aims at performing a feasibility study on the introduction of EGNSS-based rail safety services (segment analysis, localisation integrity concept at user level, service definition, acceptance analysis, roadmap production)
IMPRESS	Start in 2020	<p>The project objectives are:</p> <ul style="list-style-type: none"> Identify what are the current European safety, legal and regulatory constraints in railway sector Analyse the main technologies used nowadays for Positioning, Navigation and Timing (PNT) in the rail domain and try to predict their foreseen evolution with respect to EGNSS penetration in the rail sector within the timeframe 2022-2035. Develop a new localisation integrity concept for the on-board unit (OBU), to be nested within the ETCS Assess the different steps towards the implementation for the new EGNSS rail safety service