



**HAL**  
open science

# Scanning Tunnelling Microscopy STM, Atomic Force Microscopy AFM

Ludovic Douillard

► **To cite this version:**

Ludovic Douillard. Scanning Tunnelling Microscopy STM, Atomic Force Microscopy AFM. Doctoral. Université Paris-Saclay, Orsay, France, France. 2015. hal-04487580

**HAL Id: hal-04487580**

**<https://hal.science/hal-04487580>**

Submitted on 3 Mar 2024

**HAL** is a multi-disciplinary open access archive for the deposit and dissemination of scientific research documents, whether they are published or not. The documents may come from teaching and research institutions in France or abroad, or from public or private research centers.

L'archive ouverte pluridisciplinaire **HAL**, est destinée au dépôt et à la diffusion de documents scientifiques de niveau recherche, publiés ou non, émanant des établissements d'enseignement et de recherche français ou étrangers, des laboratoires publics ou privés.

# Scanning Tunnelling Microscopy

*Scanning Tunnelling Microscopy* STM,  
*Scanning Tunnelling Spectrometry* STS.

➤ **Principle – Electron tunnelling, quantum mechanical effect**

$\Delta E \cdot \Delta t \sim \hbar$  - G. Binnig, H. Rohrer, *Helv. Phys. Acta* **55** (1982) 726 – 1986 Nobel Prize in Physics

Consider two electrodes brought together down to a distance  $d$  of a few Å. The overlap between the electronic wave functions of the two metals becomes significant. Any voltage  $V$  applied between these two electrodes gives rise to a tunnelling current  $I_{\text{tunnel}}$ .

$$I_{\text{tunnel}} \propto V e^{(-2Kd)}$$

with  $e \cdot V \ll \Phi$ ,  $K = \frac{\sqrt{2m_e \Phi}}{\hbar}$  [1/L],  $\Phi$  work function of the electrodes.

Orders of magnitude:  $I_{\text{tunnel}} \sim 1 \text{ nA}$ ,  $V \sim 1 \text{ V}$ ,  $d \sim 1 - 10 \text{ Å} = 0.1 - 1 \text{ nm}$ .

The tunnelling current  $I_{\text{tunnel}}$  decreases by an order of magnitude when  $d$  is increased by  $1 \text{ Å}$ .

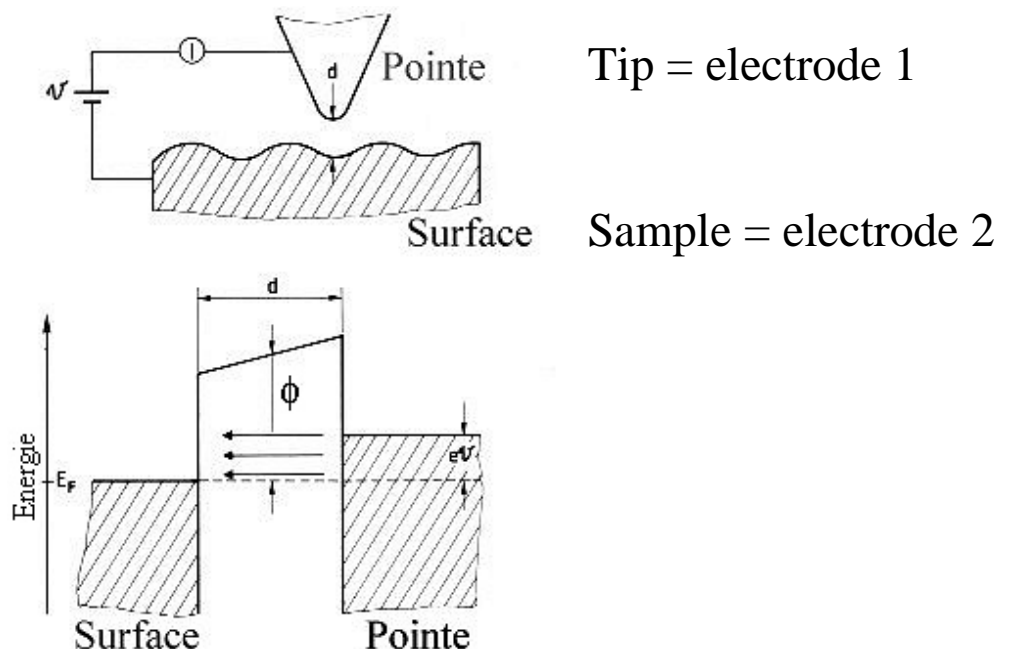

***Exploit the exponential dependence of the tunnel current  $I_{\text{tunnel}}$  on the distance  $d$  between two conductors, i.e. the tip and the sample surface, to image a solid surface with atomic resolution.***

# Scanning Tunnelling Microscopy - Instrumentation

## ➤ Instrumentation

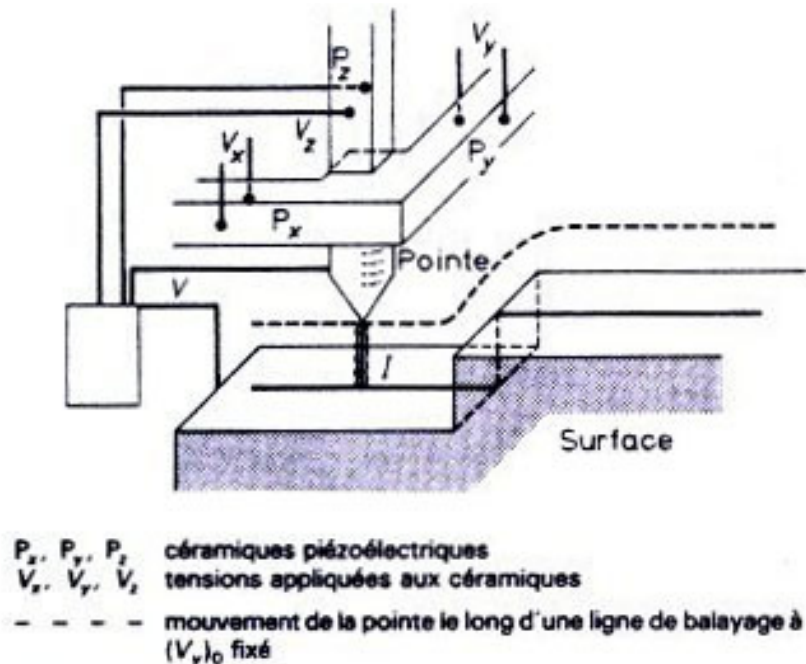

.Electrode system = (**metallic tip – conductive surface**),

.Tip scanning device (X, Y) + Z = **piezoelectric actuators**.

Example: a PZT ( $\text{Pb}(\text{Ti}, \text{Zr})\text{O}_3$ ) piezoelectric tube with electrodes and dimensions  $(L, \Phi_{\max}, \Phi_{\min}) = (12.7, 6.35, 5.84 \text{ mm})$  : spatial extensions  $\approx 5 \text{ nm/V}$  along the (X, Y, Z) directions.

.The tip height  $Z(d)$  is adjusted through a **feedback loop** to maintain a constant current  $I_{\text{tunnel}}$  at a constant bias voltage  $V_{\text{tunnel}}$ . Tunnelling setpoint  $I_{\text{tunnel}} \sim 1 \text{ nA}$ ,  $V_{\text{tunnel}} \sim 1 \text{ V}$ ,  $d \sim 1\text{-}10 \text{ \AA}$ .

.External vibration isolation system (mechanical springs).

→ Z (height) imaging mode:  $Z = f(X, Y)$  (close loop,  $I = \text{cste}$ ),

→ I (current) imaging mode:  $I = f(X, Y)$  (open loop,  $Z = \text{cste}$ ).

**Vertical resolution  $\Delta r_z \geq 0.01 \text{ \AA}$**  (exponential dependence),

**Lateral resolution limited by the radius of curvature of the tip**

**$\Delta r_{xy} \geq 1 \text{ \AA} = 0.1 \text{ nm}$ .**

**→ Atomic resolution achievable.**

# Scanning Tunnelling Microscopy

## ➤ Principle - Tunnelling current intensity - Image interpretation.

$$\frac{\partial I_{tunnel}}{\partial(eV_x)} = \rho_{surface}(E + eV)\rho_{tip}(R_{tip}, E)T(E, V)$$

$$I_{tunnel} = \int_{E_f}^{E_f + eV} \rho_{surface}(E + eV)\rho_{tip}(R_{tip}, E)T(E, V)dE$$

. $E_f$  Surface Fermi level,  $E = E_f + eV_x$  avec  $0 \leq V_x \leq V$ ,

. $\rho_{surface}$  Surface local density of states LDOS,

. $\rho_{tip}$  Tip surface local density of states at position  $R_{tip}$ ,

. $T(E, V)$  transmission coefficient of the vacuum barrier (quantum matrix element  $|M|^2 \propto \exp(-2Kd)$ ,  $K = \sqrt{2m_e\Phi} / \hbar$ ).

**In Z imaging mode, a STM picture is a measure of the integrated local densities of states of both tip and sample in an energy window close to the Fermi level.**

**The use of a tip material (W, Pt-Ir, Ir) with a flat LDOS within the energy range of the Fermi surface reduces the tip contribution.**

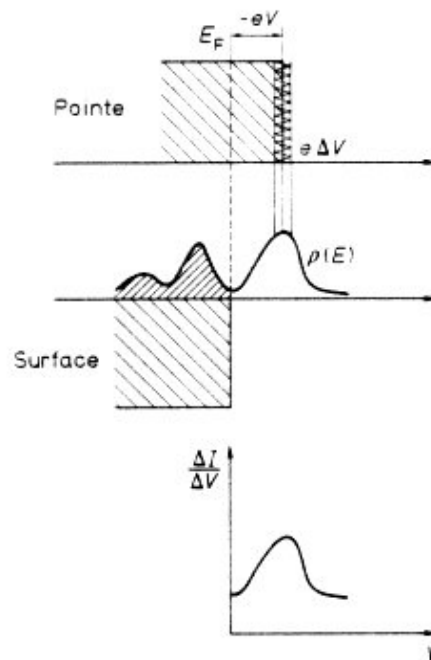

Une modulation  $\Delta V$  est superposée à la rampe de tension  $V$  appliquée entre pointe et surface et le signal  $\Delta I/\Delta V$  est mesuré à l'aide d'une détection synchrone.

**Fig. 4. - Relation entre la densité d'états électroniques de la surface analysée avec le signal  $\Delta I/\Delta V$ .**

## ➤ Applications

*Investigation of surface structures of metals and semi-conductors by direct imaging (atomic spatial resolution):*

.metals: vicinal surfaces, surface defects...

.semiconductors: surface reconstructions, surface defects...

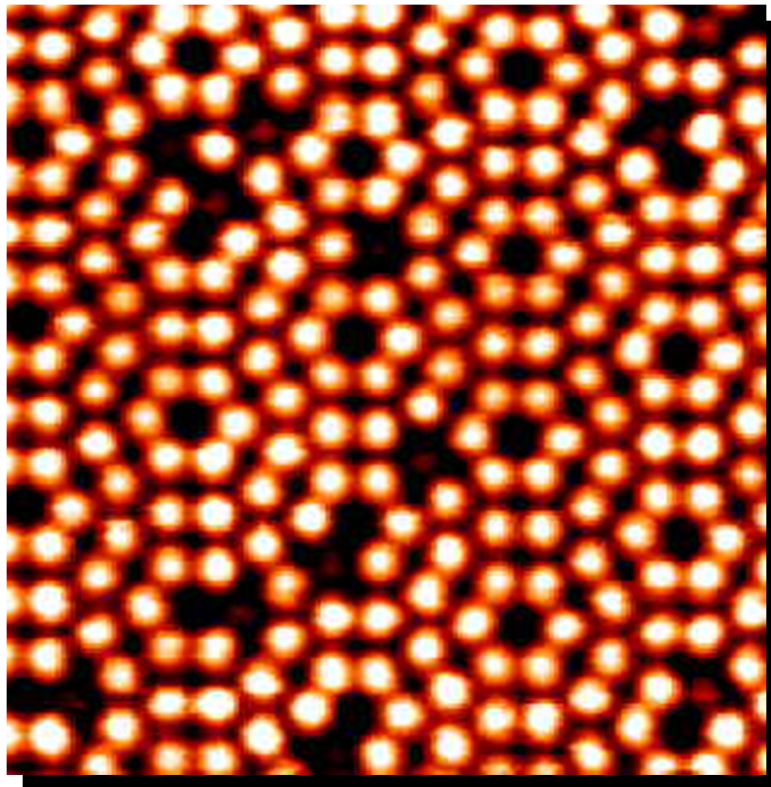

(7x7) Si(111) surface reconstruction - OMICRON GmbH

.Surface reaction, catalytic reaction, self-assembly phenomena, 2D supramolecular chemistry...

*Spectrometric investigation of the electronic structure of surface*  
Scanning Tunnelling Spectrometry STS,

In the spectroscopic mode, the tip is stationary, while the voltage is being swept.

$$\Delta I/\Delta V = f(V), d\ln I/d\ln V = f(V) \propto \text{Surface LDOS}.$$

# Atomic Force Microscopy

Atomic Force Microscopy AFM, Scanning Force Microscopy SFM, Dynamic Force Microscopy DFM, Lateral Force Microscopy LFM, Magnetic Force Microscopy MFM, Electrostatic Force Microscopy EFM...

➤ **Principle.** - G. Binnig, C.F. Quate, Ch. Gerber, *Phys. Rev. Lett.* **56** (1986) 930

*Exploits the force interaction between a tip and a sample surface as an imaging signal.*

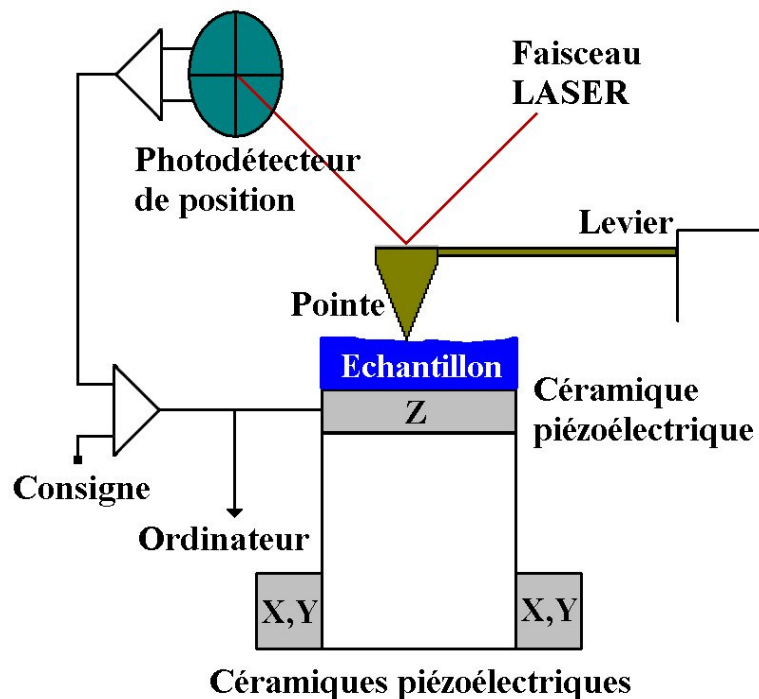

An AFM is equivalent to a STM, except that the tunnelling tip is replaced by a force sensor = **tip-cantilever assembly**.

A tip, fixed at the free end of a cantilever, is raster scanned over a sample surface (in-plane X, Y movements),

When the tip is brought into close proximity of a sample, the force between the tip and surface leads to a mechanical deflection of the cantilever  $\delta F = k \cdot \delta z$  (Hooke's law),  $k$  cantilever spring constant.

The static cantilever deflection  $\delta z$  is used as a feedback signal to image the surface (Z movement).

Tip dimensions:  $L = 2 \mu\text{m}$ ,  $R = 10 \text{ nm}$  (curvature radius),

Cantilever:  $100 \leq L \leq 200 \mu\text{m}$ ,  $10 \leq \ell \leq 40 \mu\text{m}$ ,  $0.3 \leq e \leq 2 \mu\text{m}$ ,

Tip surface distance:  $0.1 \leq d \leq 500 \text{ nm}$ .

## Atomic Force Microscopy - Types of the force

### ➤ Types of the force.

The imaging forces are mainly electromagnetic in nature.

#### *.Short range repulsive forces*

Repulsive term due to the Pauli Exclusion Principle that prevents the collapse of matter,

Repulsive forces  $F \propto 1/r^n$ ,  $n \geq 9$ ,  $r$  interatomic distance,

Short range force  $r \approx 0.1$  nm.

#### *.van der Waals – London force.*

Several terms: (i) force between two permanent dipoles (Keesom force), (ii) force between a permanent dipole and a corresponding induced dipole (Debye force), (iii) force between two instantaneously induced dipoles (London dispersion force).

(Mainly) attractive force  $F \propto 1/r^7$ ,  $r$  interatomic distance,

Long range force,  $0.1 \text{ nm} \leq r \leq 100 \text{ nm}$ ,

#### *.Electrostatic force.*

Electrostatic interaction between coulombic charges,

The electrostatic force between a tip and a surface (both conductive) is given by  $F \propto RV^2/r$ ,  $R$  tip radius,  $V$  applied electrostatic potential,  $r$  tip-to-surface distance,

Long range force,  $0.1 \text{ nm} \leq r \leq 100 \text{ nm}$ ,

#### *.Magnetic force.*

Interaction between two magnetic dipoles,

The magnetic force between a tip and a surface is given by  $\vec{F} \propto \vec{m} \nabla \vec{H}$ ,  $m$  tip magnetic moment (dipole),  $H$  magnetic stray field from the sample surface,

Long range force,  $0.1 \text{ nm} \leq r \leq 100 \text{ nm}$ ,

## Atomic Force Microscopy - Types of the force

### ➤ Types of the force – Surrounding media.

The type of the atomic force is significantly altered by the nature of the surrounding media (gas, liquid, vacuum).

#### *.Capillary (meniscus) force.*

Due to intermolecular forces between liquid and solid surfaces. For instance, in the presence of water humidity (air) a meniscus appears around the tip probe.

Attractive force,  $F_{\max} \propto R \cdot \gamma \cdot \cos(\Theta)$ , R tip curvature radius,  $\gamma$  surface tension of the liquid phase,  $\Theta$  contact angle.

### ➤ Orders of magnitude of atomic force.

#### Contact force

$F_z = \partial E / \partial z \approx \Delta E / \Delta z$ ,  $\Delta E$  [eV] bond energy,  $\Delta z$  [Å] spatial range where the force is predominant,

Ionic bond  $\Delta E_{\text{ionique}} = 10$  eV,  $\Delta z = 1.6$  Å  $\Rightarrow F_z \approx 1 \cdot 10^{-8}$  N = 10 nN

#### van der Waals force and force gradient

van der Waals bond  $\Delta E_{\text{van der Waals}} = 0.01$  eV (10 meV),  $\Delta z = 1.6$  Å,  
 $F_{\text{van der Waals}} = 1 \cdot 10^{-11}$  N = 0.01 nN

$F_z \approx 5 \cdot 10^{-13}$  N at distance  $d = 10$  nm = 100 Å, corresponding to a force gradient of about  $F' = \partial F_z / \partial z \approx 1 \cdot 10^{-4}$  N/m ( $\delta z \approx 5 \cdot 10^{-3}$  Å,  $k = 1$  N/m).

#### Electrostatic force

$F = \pi \epsilon_0 R V^2 / r = \pi \epsilon_0 \cdot 100$  nm  $\cdot (1$  V)<sup>2</sup> / 0.5 nm = 5.55 nN.

#### Capillary force

$F_{\max}$  (R = 100 nm, H<sub>2</sub>O)  $\approx 1 \cdot 10^{-7}$  N = 100 nN (ever-present in air).



## Atomic Force Microscopy – Imaging Modes

### ➤ Primary modes of imaging in an atomic force microscope.

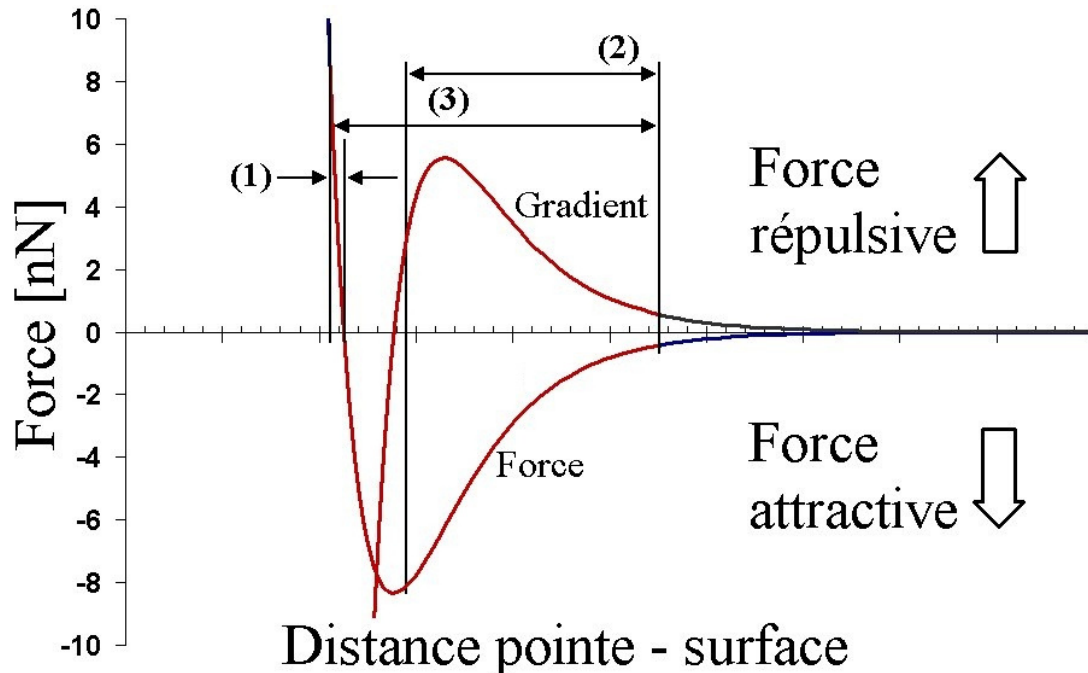

An atomic force microscope makes use of **3 primary imaging modes**, namely: the **contact**, the **non-contact** and the **intermittent contact modes**.

(1) **Contact mode** corresponds to **short tip-to-sample distances** of a few Å ( $\leq 0.3$  nm) and **repulsive contact forces** (Born - Pauli forces). The cantilever deflection is used as a feedback signal to image a constant isoforce profile,

(2) **Non-contact mode** corresponds to **large tip-to-sample distances** in the 1 – 100 nm range, where **long range attractive forces are encountered** (van der Waals, magnetic, electrostatic forces). The probe oscillates above the surface to sense the force gradient,

(3) **Intermittent contact mode or Tapping mode<sup>TM</sup>** is a combination of the previous modes. Tip-to-sample distance 0.3 – 100 nm.

Both **non-contact** and **tapping modes** involves an oscillating probe and so are described as **dynamic modes**.

## Atomic Force Microscopy - Contact Mode

In **contact mode**, the tip contacts on the surface (in the classical physics sense) and probes short range repulsive forces (Born - Pauli forces) = **repulsive force imaging mode**.

Force range  $1 \cdot 10^{-9} \text{ N} = 1 \text{ nN} \leq F_{\text{contact}} \leq 1 \cdot 10^{-7} \text{ N} = 100 \text{ nN}$ ,

Short tip-to-surface distances:  $d \leq 0.3 \text{ nm} = 3 \text{ \AA}$ ,

Normal topographic resolution  $\Delta r_z \geq 0.01 \text{ nm} = 0.1 \text{ \AA}$ ,

In-plane topographic resolution  $\Delta r_{x,y} \geq 1 \text{ nm} = 10 \text{ \AA}$ ,

### ➤ Imaging principle at *constant force setpoint*.

1) Determination of the **contact force** by measure of the deflection of the free end of the tip – cantilever assembly.

.Deflection  $\delta z$  of a cantilever of spring constant  $k$ ,

.Acting force on the cantilever (Hooke's law)  $F_{\text{contact}} = k \cdot \delta z$ ,

2) The cantilever deflection is used as a **feedback signal to maintain the tip-surface distance**  $d$  (through  $Z_{\text{sample}}$  movement), i.e. to probe the isoforce profile corresponding to the **force setpoint**,

3) Raster scan of the sample through the use of **piezoelectric actuators** (in-plane  $X_{\text{sample}}$ ,  $Y_{\text{sample}}$  movements).



**Topographic image of Z-isodisplacements, i.e. isoforce profiles,  
Image of the local isodensity of electronic states** in the case of a fully rigid sample.

High resolution gives a mapping (symmetry & periodicity) of the surface minima interaction potential, **ultimate resolution = surface lattice cell**,

A contact mode AFM is equivalent to a high resolution profilometer.

## Atomic Force Microscopy - Contact Mode

### ➤ Atomic force microscopy – Cantilever design.

(i) Maximum force sensitivity  $\delta F = k \cdot \delta z$

⇔ Low spring constant  $k \approx 1 - 10 \text{ N/m}$ ,

(ii) Minimal vibrational sensitivity (vibration isolation)

⇔ High resonance frequency  $\nu_0$ ,  $\nu_0 = (k/m)^{1/2}$ ,  $m$  effective mass of the cantilever,

⇔ Reduced mass  $m$  and dimensions ( $L \times \ell \times e$ ).

1) Manual fabrication from metallic wire and foils (Au, W).

AFM (1986) Au foil  $0.8 \times 0.25 \times 0.025 \text{ mm}^3 + C_{\text{diamond}} \text{ Tip}$ ,

2) Microfabrication by lithography, CVD... from Si, SiO<sub>2</sub>, Si<sub>3</sub>N<sub>4</sub> materials.

Cantilevers of various shapes and mechanical characteristics ( $k, \nu_0$ ) + integrated tip (conical, tetrahedral, pyramidal).

$0.001 \text{ N/m} \leq k \leq 100 \text{ N/m}$ ,

$1 \text{ kHz} \leq \nu_0 \leq 500 \text{ kHz}$ ,

$5 \text{ nm} \leq \text{tip curvature radius } R \leq 30 \text{ nm}$ .

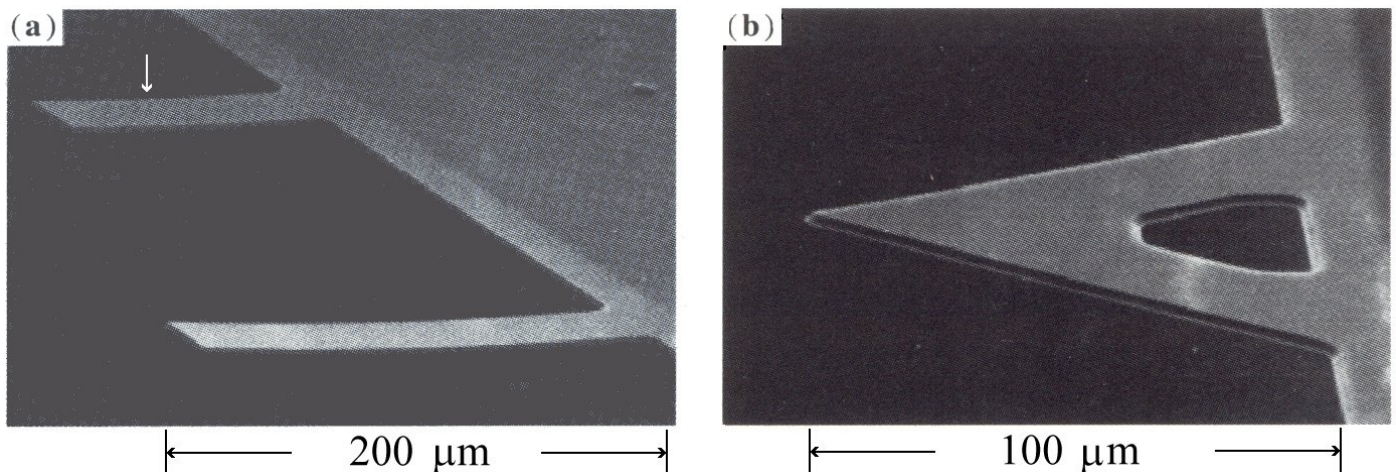

Microfabricated SiO<sub>2</sub> cantilevers. (a) Rectangular cantilever with dimensions  $200 \times 20 \times 1.5 \text{ }\mu\text{m}$ ,  $k = 1 \text{ N/m}$  and  $\nu_0 = 120 \text{ kHz}$ , (b) V-shape cantilever to increase torsion stiffness (cf. LFM) - SEM images.

## Atomic Force Microscopy - Contact Mode

### ➤ Atomic force microscopy – Instrument design.

#### .Measure of the cantilever deflections.

$$\text{NA.: } \delta z = \delta F / k = 1 \text{ nN} / 10 \text{ N/m} = 0.1 \text{ nm} = 1 \text{ \AA}$$

#### .Tunnelling method (1986 AFM-STM design).

Operate a complete STM on top of the cantilever (Au foil),

Minimal detectable deflection  $\delta z \geq 0.01 \text{ \AA} = 0.001 \text{ nm}$ ,

Required a clean metallic coating on top of the cantilever.

#### .Optical beam-deflection method (Meyer, Amer 1988)

The cantilever deflections are measured by detecting the displacements of a laser beam reflected off the back of the cantilever.

The spatial variations of the reflected laser beam are detected by a **Position Sensitive Detector (PSD)**, segmented into four quadrants. The precise position of the laser beam is deduced from the distribution of the four individual photocurrents.

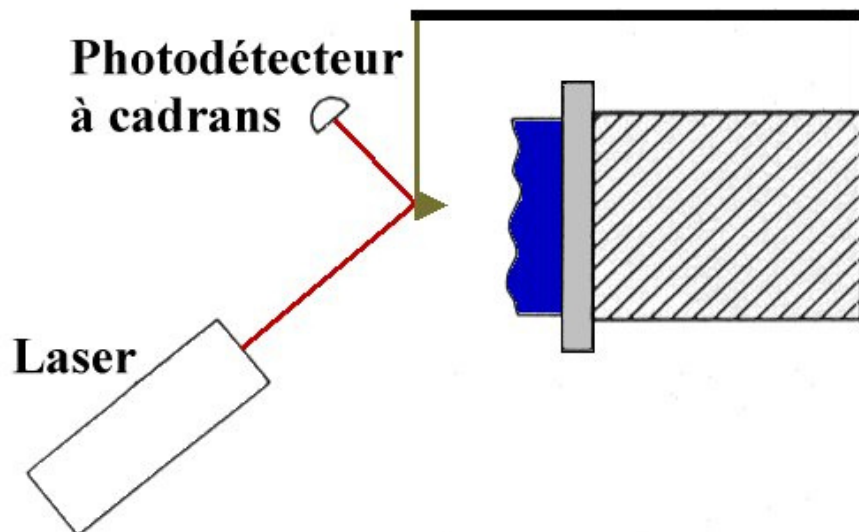

Minimal detectable deflection  $\delta z \geq 0.01 \text{ \AA} = 0.001 \text{ nm}$ ,

Spatial resolution along the surface normal (isoforce mode)  $\Delta r_z \geq 0.01 \text{ nm}$

Usual set-up of commercial AFM instruments.

## Atomic Force Microscopy - Contact Mode

### ➤ Atomic force microscopy – Instrument design.

#### .Optical interferometry

Take advantage of optical interferences between two reflected laser beams, (i) one from the fixed end of a cantilever and (ii) the second from its free end. Another widespread set-up uses a semi-transparent monomode fiber end.

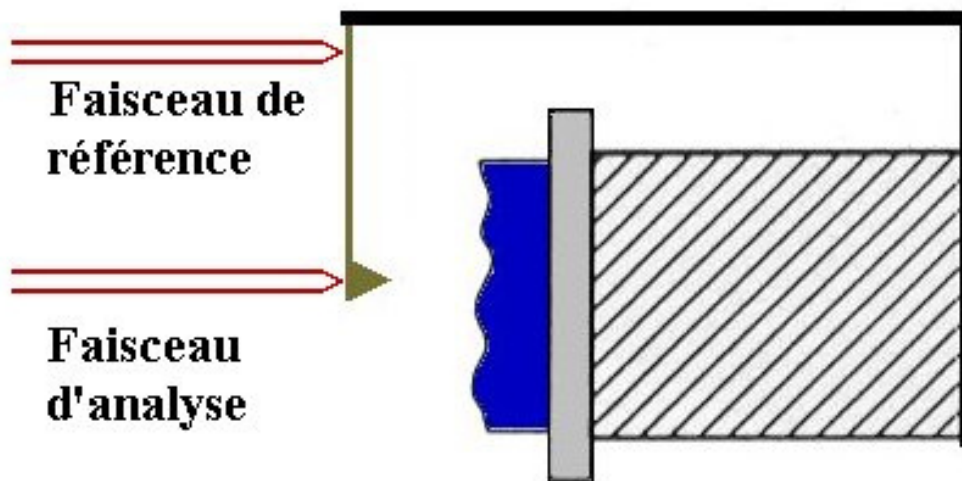

#### .Piezoelectric method.

Cantilevers made of piezoelectric materials (PZT ceramic, quartz single crystal...) generate a voltage in response to mechanical deformations. A force measurement is carried out by probing of the electrical response of the cantilever:  $\delta F \propto k\delta z \propto \delta V$ , avec  $k \approx 0.04 \text{ N/m}$

#### .Piezoelectric method – Tuning fork.

Use of a quartz tuning fork (U-shaped acoustic resonator) instead of a cantilever. Advantages are high amplitude and phase sensitivities, high mechanical quality factor  $Q$ , large spring constant  $k$  (detection of piconewton forces =  $1 \cdot 10^{-12} \text{ N} = 1 \text{ pN}$ ).

#### .Capacitive method (capacitance sensors).

Measure of the change of capacitance of a capacitor whose internal distance is linked to the cantilever deflection.

## Atomic Force Microscopy – Non contact dynamic mode

In **non contact mode**, the tip-surface interactions are extremely weak, mainly **attractive** and **long-range** in nature.

Force range:  $1 \cdot 10^{-15} \text{ N} = 1 \cdot 10^{-6} \text{ nN} \leq F_{\text{contact}} \leq 1 \cdot 10^{-10} \text{ N} = 0.1 \text{ nN}$ ,

Large tip-surface distance:  $d \geq 0.3 \text{ nm} = 3 \text{ \AA}$ ,

Normal topographic resolution  $\Delta r_z \geq 0.01 \text{ nm} = 0.1 \text{ \AA}$ ,

In-plane topographic resolution  $\Delta r_x \geq 0.1 \text{ nm} = 1 \text{ \AA}$ ,

Direct force measurement is difficult  $\delta z \approx 5 \cdot 10^{-3} \text{ \AA} \Leftrightarrow$

Measure of the **force derivative along the normal**  $F'_z = \partial F_z / \partial z$   
by an **oscillating probe**.

➤ **Imaging principle at constant force gradient setpoint.**

1) The cantilever oscillates at a driven fixed amplitude  $A$  (10 – 100 nm) and a fixed frequency  $\nu_1$  (**dynamic mode**) close to, but different from its resonance frequency  $\nu_0$  ( $\approx 10\%$  off resonance),

2) The **normal force derivative**  $F'_z = \partial F_z / \partial z$  is measured, either by:

(a) a change of the cantilever resonant frequency  $\Delta \nu_0$  caused by the cantilever-surface interaction,

(b) a change of the cantilever amplitude  $\Delta A$  caused by the cantilever-surface interaction,

3) The cantilever resonant frequency  $\nu_0$  (resp. oscillation amplitude  $A$ ) is used as a **feedback signal to maintain the tip-surface interaction** (through  $Z_{\text{sample}}$  movement), i.e. to probe the isogradient of force profile corresponding to the predefined **setpoint**,

4) Raster scan of the sample through the use of **piezoelectric actuators** (in-plane  $X_{\text{sample}}$ ,  $Y_{\text{sample}}$  movements).

**⇒ Topographic image of force isogradient profile,  
Atomic resolution is achievable.**

## Atomic Force Microscopy – Non contact dynamic mode

➤ **Force gradient measurement** - Case  $\Delta A \ll d$ .

$$\nu'_0 = \nu_0 \sqrt{1 - \frac{F'_z}{k}} \quad \text{with} \quad F'_z = \hat{n} \cdot \nabla (\hat{n} \cdot F) \approx \frac{\partial F_z}{\partial z}, \quad \hat{n} \approx \hat{z}$$

$F'_z$  force gradient along the surface normal  $\hat{n}$ ,

$\nu_0$  cantilever frequency resonance in vacuum (far from any surface interaction),

$\nu'_0$  frequency resonance in close proximity to an interacting surface sample.

Usually for increasing attractive force (*mode non contact*), the resonance frequency decreases.  $F'_z > 0 \Rightarrow \nu'_0 < \nu_0$

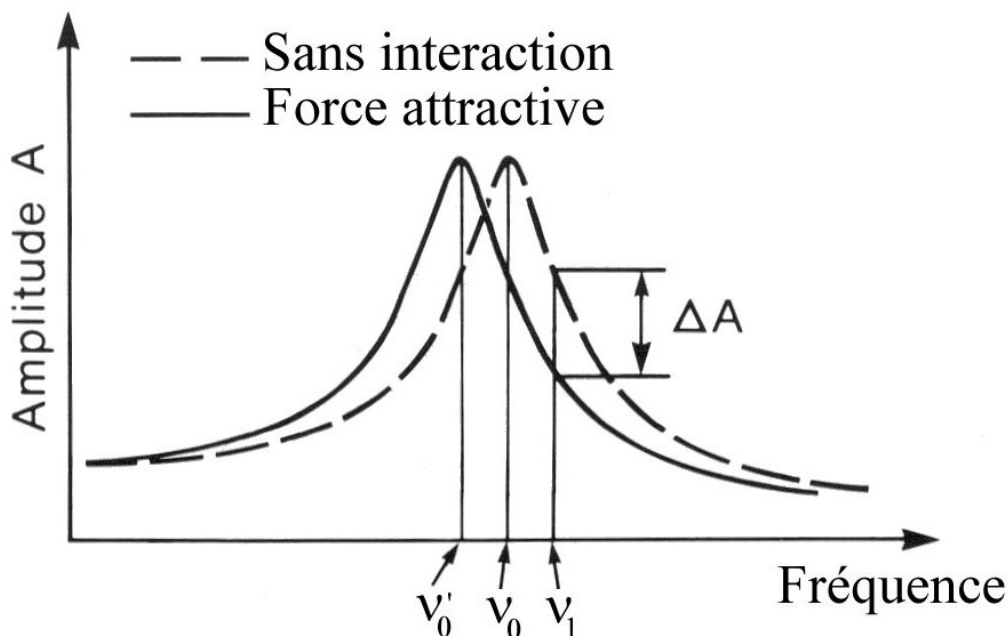

The change in resonance frequency  $\Delta \nu_0 = \nu'_0 - \nu_0$  upon probe–surface interaction can be determined, either:

(i) directly by frequency modulation (FM) *J. Appl. Phys.* **69** (1991) 668 and  $\Delta \nu_0 \approx -(\nu_0 / 2k) \cdot (\partial F_z / \partial z)$ ,

(ii) indirectly by amplitude modulation  $\Delta A$  ”**slope detection method**” *J. Vac. Sci. Technol. A* **6** (1988) 266.

Detectable force gradients  $F'_z \approx 1 \cdot 10^{-4}$  N/m, i.e.  $F_z \approx 5 \cdot 10^{-13}$  N at distance of the order of 10 nm ( $\delta z \approx 5 \cdot 10^{-3}$  Å,  $k = 1$  N/m).

## Atomic Force Microscopy – Non contact dynamic mode

➤ **Force gradient measurement** - The slope detection method.

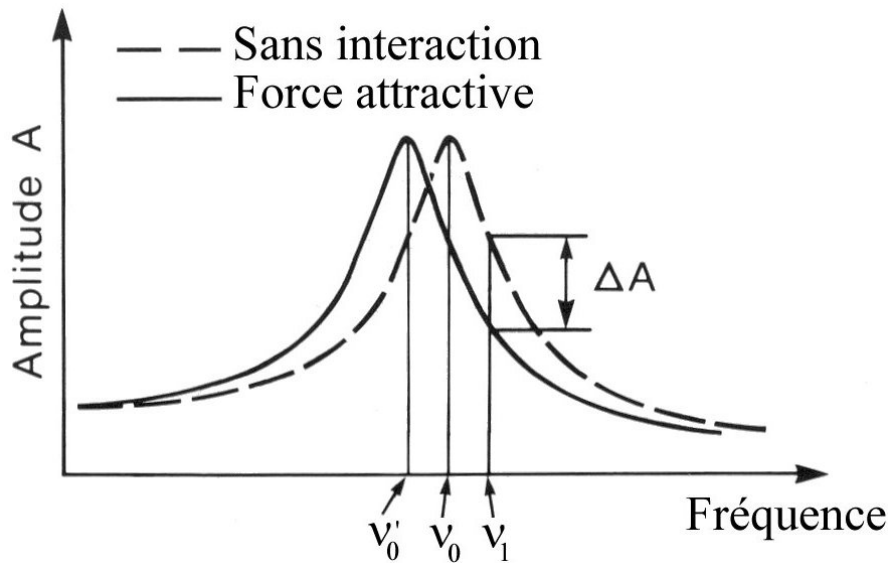

The cantilever is mounted onto a piezoelectric actuator and driven at a fixed amplitude  $A = f(\nu)$  at a fixed frequency  $\nu_1$  slightly off resonance ( $\approx 10\%$  off resonance).

**Any shift in the cantilever frequency resonance  $\Delta\nu = \nu_0' - \nu_0$  causes a change in the driven amplitude  $\Delta A$  relative to the driving signal  $\nu_1$ .**

The biggest change  $\Delta A$  for a given change in resonance frequency  $\Delta\nu$  is obtained at **the steepest portion of the A vs  $\nu$  Lorentzian curve:**

$$\frac{\Delta A}{\Delta \nu} = \frac{4A_0 Q}{3\sqrt{3}\nu_0} \quad A_0 \text{ amplitude at resonance } \nu_0, \nu_0 = c\sqrt{k}, Q \text{ resonance quality}$$

factor ( $Q \approx 1.10^4$  under UHV,  $\leq 100$  in liquid).

$$\Delta\nu = |\nu_0' - \nu_0| = \frac{\nu_0}{2k} \frac{\partial F_z}{\partial z}, \text{ for derivative } \frac{\partial F_z}{\partial z} \ll k$$

$$\text{So } \Delta A = \left( \frac{2A_0 Q}{3\sqrt{3}k} \right) \frac{\partial F_z}{\partial z} \Leftrightarrow \Delta A \propto \text{force derivative}$$



## Intermittent contact mode (tapping mode™)

The **intermittent contact mode (tapping mode™)** constitutes a compromise between the contact and non contact modes. *Digital Instruments Inc.* (1993) [www.di.com](http://www.di.com)

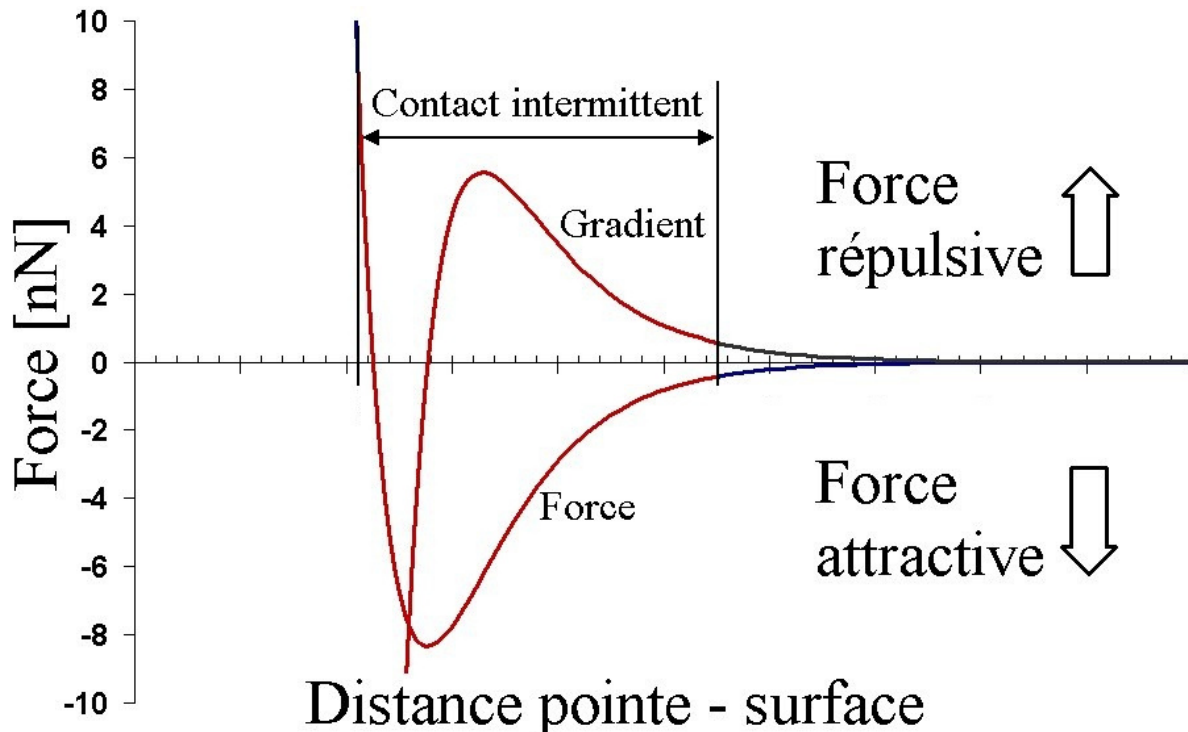

.The **cantilever oscillates** at a frequency close to its resonant frequency ( $\nu_1 \approx 300$  kHz under vacuum, much lower in a liquid.),

.Oscillation amplitude  $A$  (20 – 100 nm) is adjusted so that the probe lightly contacts (“taps”) on the surface at the bottom of its oscillating movement: **intermittent physical contact**,

.Images of constant tip-to-sample interaction (constant force gradient) are obtained by taking oscillation amplitude or phase as input of the Z feedback loop.

.Reduced normal force component,  $F_z \leq 1 \cdot 10^{-9}$  N = 1 nN,

.No lateral friction force (low tip damage),

.Spatial resolution identical to contact mode  $\Delta r_{x,y} \geq 1$  nm,

**⇒ Allows imaging of soft samples that are easily damaged.**  
**Imaging mode for soft matter (polymer, biology material, thin organic film) and inhomogeneous surfaces.**

## Atomic Force Microscopy – Imaging modes

### ➤ AFM imaging modes.

#### *.Isoforce mode (constant force),*

The static cantilever deflection  $\delta Z_{\text{cantilever}}$  is used as a Z feedback signal (closed loop) to image a constant isoforce profile (**contact mode**),

$$\rightarrow \text{Image} \equiv \Delta Z_{\text{sample}} (\delta Z_{\text{cantilever}} = \text{cste}) = f(X_{\text{sample}}, Y_{\text{sample}}),$$

#### *.Constant height mode,*

No Z feedback control of the cantilever deflection (open loop) (**mode contact**),

$$\rightarrow \text{Image} \equiv \delta Z_{\text{cantilever}} (\Delta Z_{\text{sample}} = \text{cste}) = f(X_{\text{sample}}, Y_{\text{sample}}),$$

#### *.Constant force gradient,*

The change in amplitude  $\Delta A$  (resp. in resonance frequency  $\Delta \nu$ ) is used as an input signal for the Z feedback loop to image a constant force gradient  $(\partial F_z / \partial z)_{\text{cantilever}}$  (**non contact mode**),

$$\rightarrow \text{Image} \equiv \Delta Z_{\text{sample}} \left( \frac{\partial F_z}{\partial z} = \text{cste} \right) = f(X_{\text{sample}}, Y_{\text{sample}}),$$

#### *.Spectrometric mode*

Measure of the force-distance curves  $F = f(Z)$  along the surface normal at specific surface positions (X, Y).

## Atomic Force Microscopy – MFM Variant

➤ **Magnetic Force Microscopy MFM.** Y. Martin, H. K. Wickramasinghe, *Appl. Phys. Lett.* **50** (1987) 1455.

The use of a tip possessing a magnetic moment (Ni, Fe, Co) or coated with a magnetic thin film (FeNdB, CoPtCr, CoZrNb...) gives rise to tip-surface interactions magnetostatic in nature.

Detection of the magnetic force allows magnetic imaging of the surface, i.e. imaging of domain walls (Bloch, Neel), closure domains, recorded magnetic bits...

**"Lift height" scanning procedure.** MFM operates in two steps:

(i) mapping of the topographic profile of the surface in **contact mode** (short range repulsive force),

(ii) mapping of the long range magnetic force ( $20 \text{ nm} \leq d \leq 500 \text{ nm}$ ) in **non contact dynamic mode**,

.Spatial lateral resolution  $10 \text{ nm} \leq \Delta r_{x,y} \leq 100 \text{ nm}$

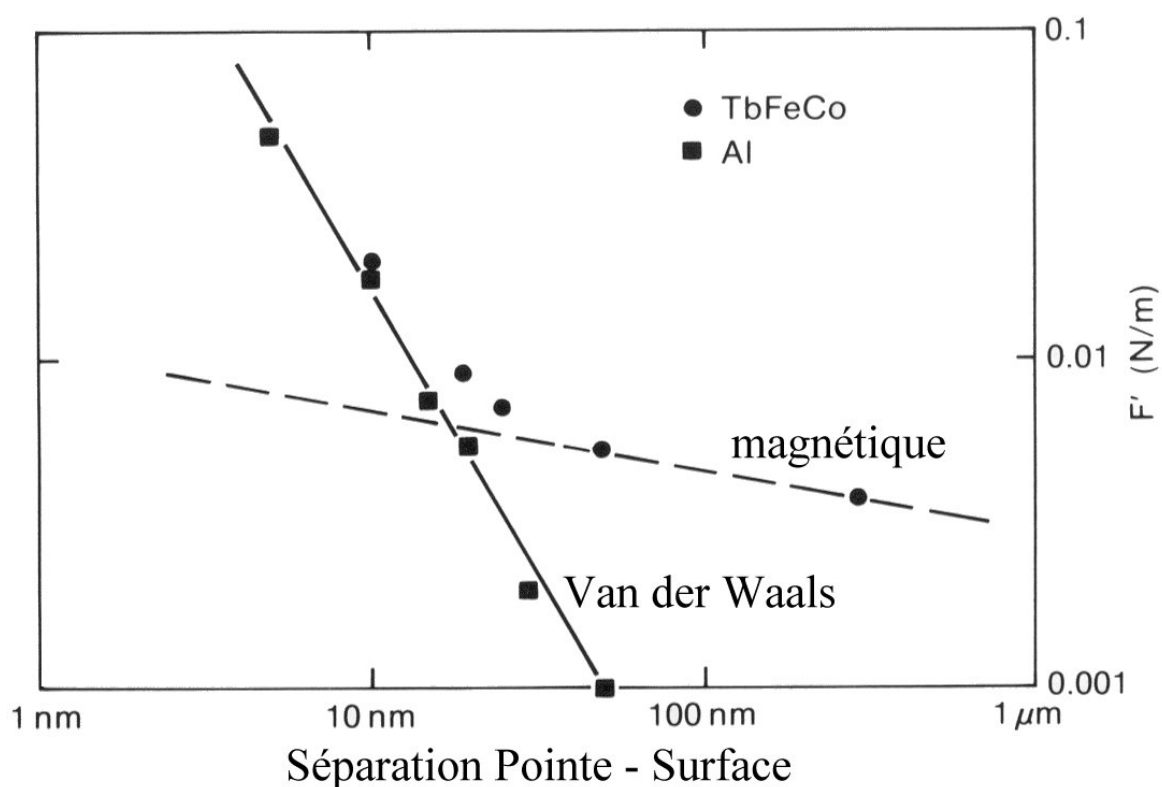

## Atomic Force Microscopy - MFM Variant

### .Magnetic Force Microscopy MFM - Lift Mode™.

Magnetic imaging is conducted in two passes to enhance the magnetic contrast (*Digital Instruments Inc*):

**.Pass n°1:** Measure of the topographic profile of each scan line in **contact or intermittent mode** where mgn interaction  $\ll$  VdW, electrostatic and atomic contact forces,

**.Pass n°2:** The magnetized tip is then lifted away from the surface by a distance of about 20 – 500 nm and magnetic force gradients are measured on a profile tracking the topographic information (open feedback loop).

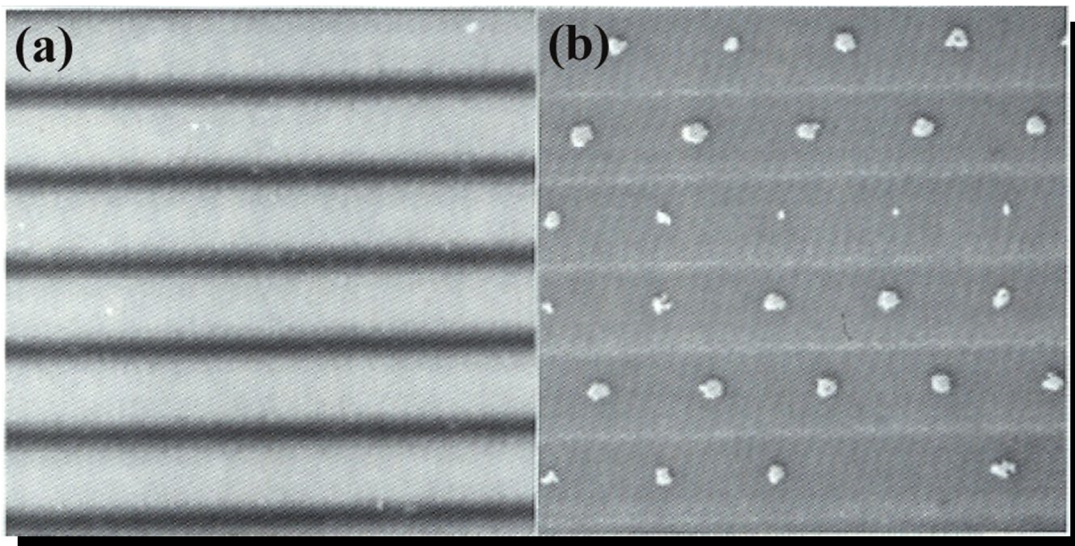
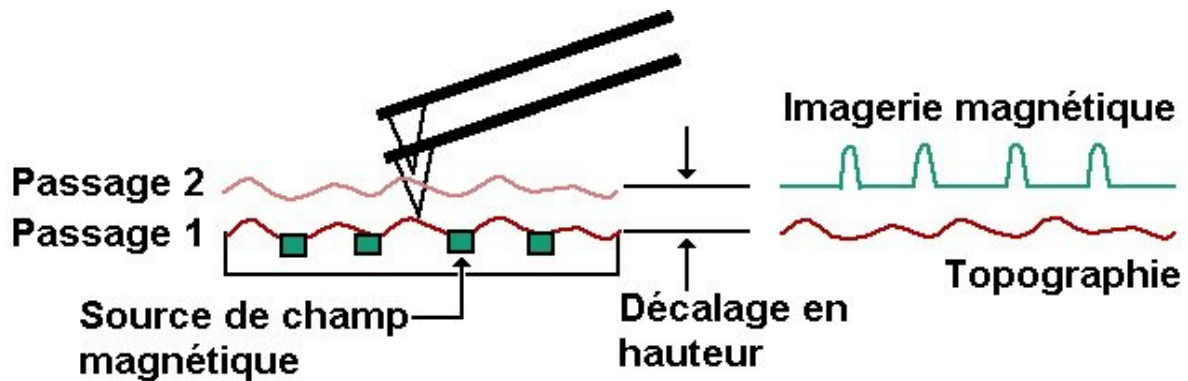

Surface of a magneto-optic disk (*mode Lift*). (a) Surface topography in intermittent (tapping) mode, (b) Mapping of the magnetic force gradient in dynamic mode at constant height (signature of magnetic bits, writing laser of various irradiances),  $\Delta r_x \approx 10$  nm, tip + thin film FeNdB. *J. Vac. Sci. Technol. A* **8** (1990) 406.

## Atomic Force Microscopy - LFM Variant

### ➤ Lateral Force Microscopy LFM.

In parallel to the measure of the force component along the normal direction, detection of the *lateral frictional forces* gives access to the mapping of the frictional coefficient. The corresponding microscopy is called **Lateral Force Microscopy (LFM)**.

Frictional forces are detected by measure of the lateral deflection (*torsional deflection*) of the cantilever when it moves horizontally along the surface plane.

The common force detection set-up of a LFM microscope is the optical beam deflection method. Use of a four quadrant **Position Sensitive Detector (PSD quad cell)** allows for the simultaneous recording of normal (AFM) and lateral force (LFM) components during sample scanning.

Imaging mode = *Contact mode*

Lateral spatial resolution  $\Delta r_{x,y} \geq 1 \text{ nm} = 10 \text{ \AA}$

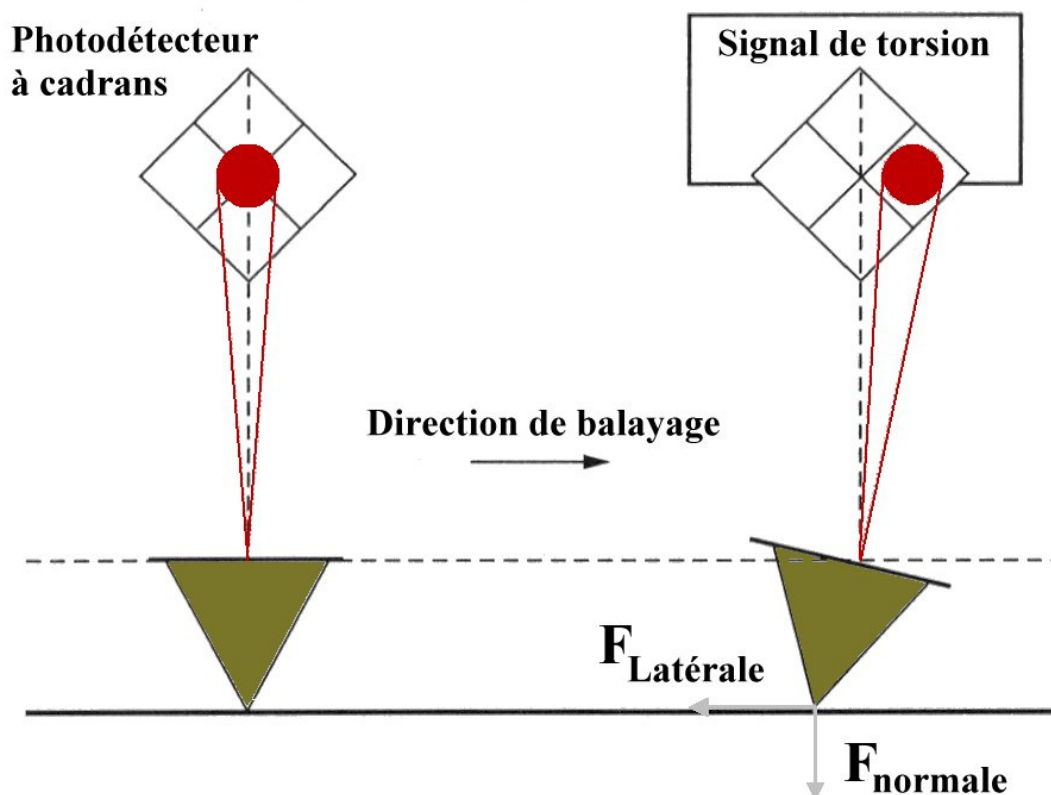

## Atomic Force Microscopy - LFM Variant

### ➤ Lateral Force Microscopy LFM.

The mapping of the lateral forces contains information of both *surface composition* (frictional coefficient, adhesion) and *topography roughness*.

Indeed, any change in torsional cantilever deflection has its origin either in:

- 1) a change of the local frictional coefficient due to inhomogeneity in surface composition,
- 2) a change in surface roughness (slopes, atomic step edges).

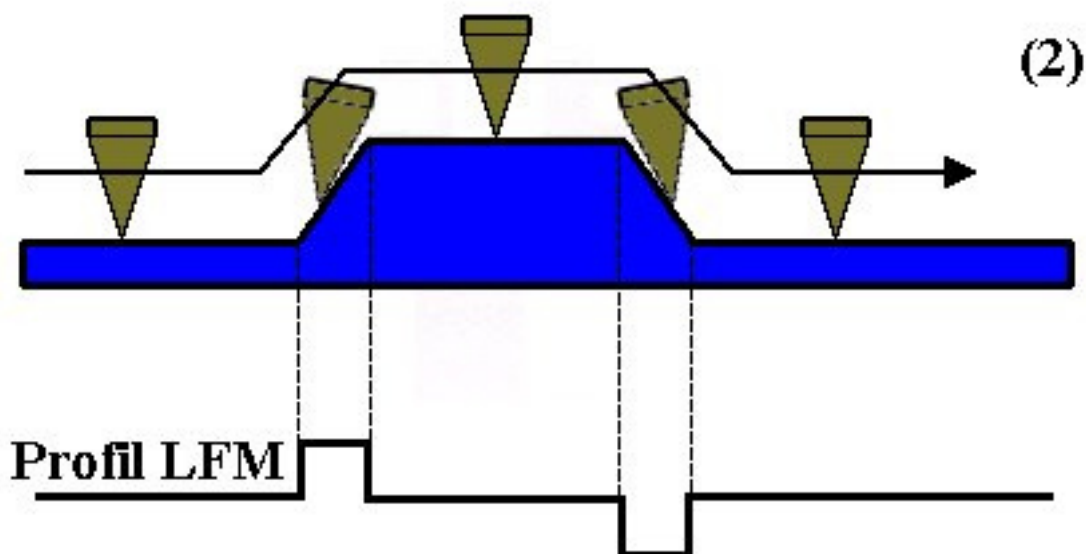
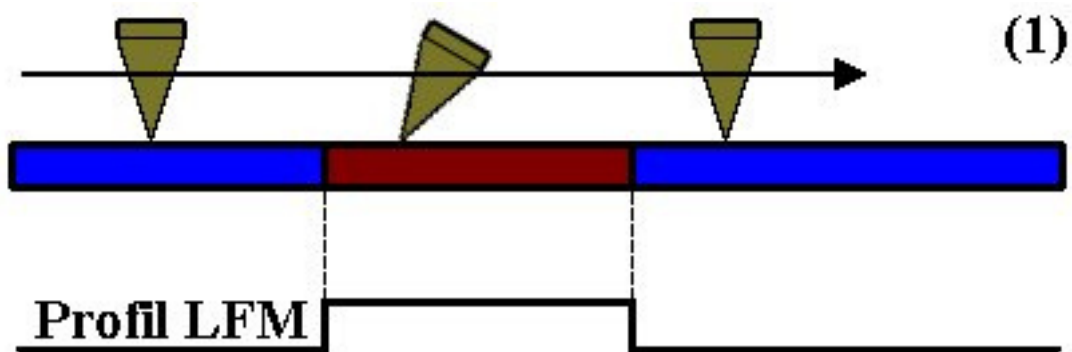

## Atomic Force Microscopy - LFM Variant

➤ **Example.** Lateral force imaging of adhesion contrast of an inhomogeneous surface.

Lateral force microscope image ( $16 \times 16 \mu\text{m}^2$ ) of a flower-shaped condensed monolayer domain of a thiolipid transferred onto a mica substrate. It is surrounded by a disordered phase.

LFM reveals the frictional contrast between the petals associated with the molecular tilt azimuth = **anisotropy of the molecular adhesion forces.**

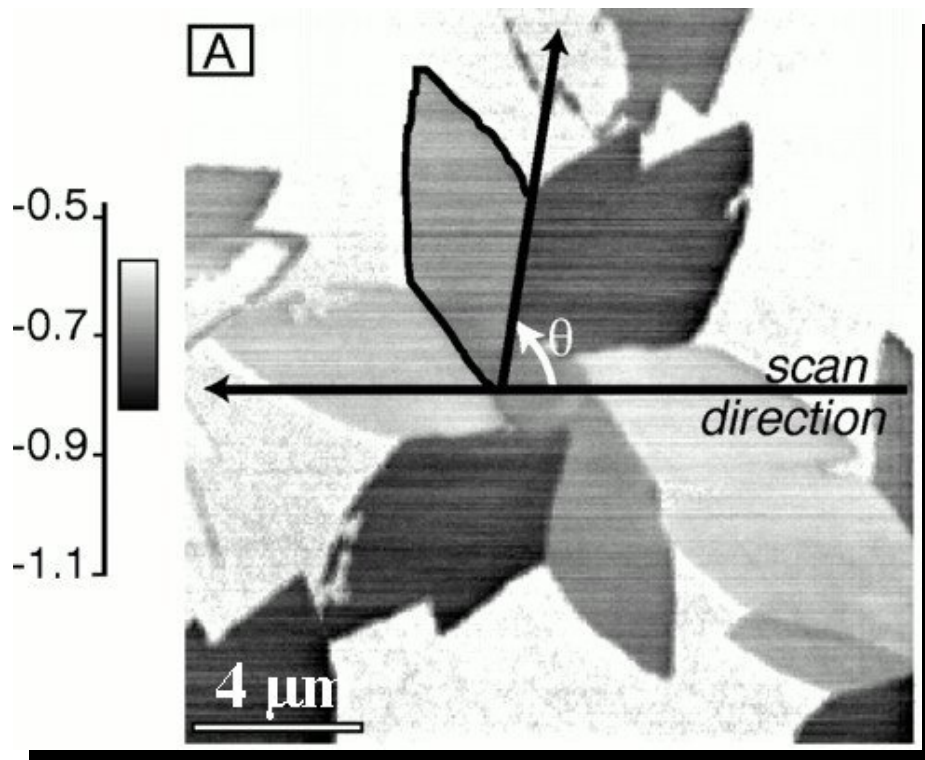

Adapted from M. Liley, D. Gourdon, D. Stamou, U. Meseth, T. M. Fischer, C. Lautz, H. Stahlberg, H. Vogel, N. A. Burnham, C. Duschl, *Science*, **280** (1998) 273.

## Atomic Force Microscopy - EFM Variant

### ➤ Electrostatic Force Microscopy EFM.

The use of a metallic tip or a tip coated with a thin metallic film ( $\text{Si}_3\text{N}_4 + \text{PtIr}_5$ ) gives rise to tip-surface interactions electrostatic in nature.

Electrostatic forces are long range forces due to the attraction or repulsion of separated charges.

In common EFM set-up, the tip-surface junction is polarized under a bias voltage  $\Delta V$  and the electrostatic forces arise from a **capacitive effect** (tip/vacuum/surface = capacitor).

$$F_z = \frac{1}{2} \frac{\partial C(x, y, z)}{\partial z} (V_{\text{tip}}(t) - V_{\text{sample}}(x, y, t) - V_{\text{CPD}})^2$$

$V_{\text{tip}}$  potential of the tip [V] = degree of freedom,

$V_{\text{sample}}$  surface potential [V],

$V_{\text{CPD}}$  Contact potential difference due to the difference in work functions of both tip and sample, a few mV [V].

EFM imaging is conducted either in *dynamic non contact* or *Lift mode* (nullifying voltage method),

Spatial lateral resolution  $\Delta r_{x,y} \geq 10 \text{ nm}$

EFM and its variants probe:

.the distribution of surface charges (trapped defects),

.the surface potential map of active devices = **Surface Potential**

**(SP) Imaging,**

.the work function map of a surface (Kelvin probe microscopy)

...



## Atomic Force Microscopy - EFM Variant

### ➤ EFM imaging. Examples. EFM Lift mode.

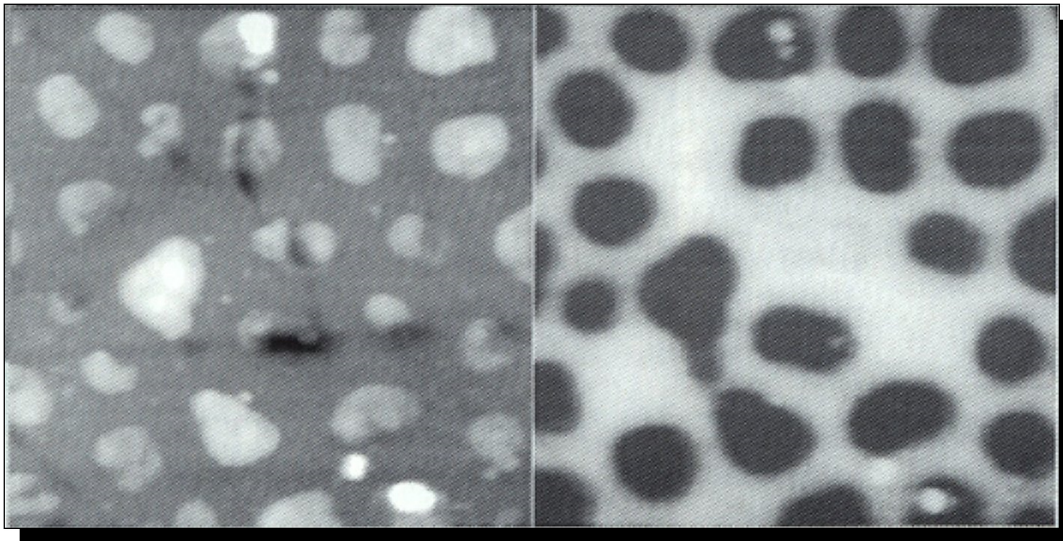

Section of a working electric cable = Cu wires embedded in an epoxy medium.

(a) Topography (AFM) in intermittent contact mode  $2 \times 2 \mu\text{m}^2$ ,

(b) Map of the electric field force gradient (EFM, *Lift mode*),  $2 \times 2 \mu\text{m}^2$ .

Source *Digital Instruments Inc., Santa Barbara CA USA*.

### ➤ Surface Potential (SP) Imaging

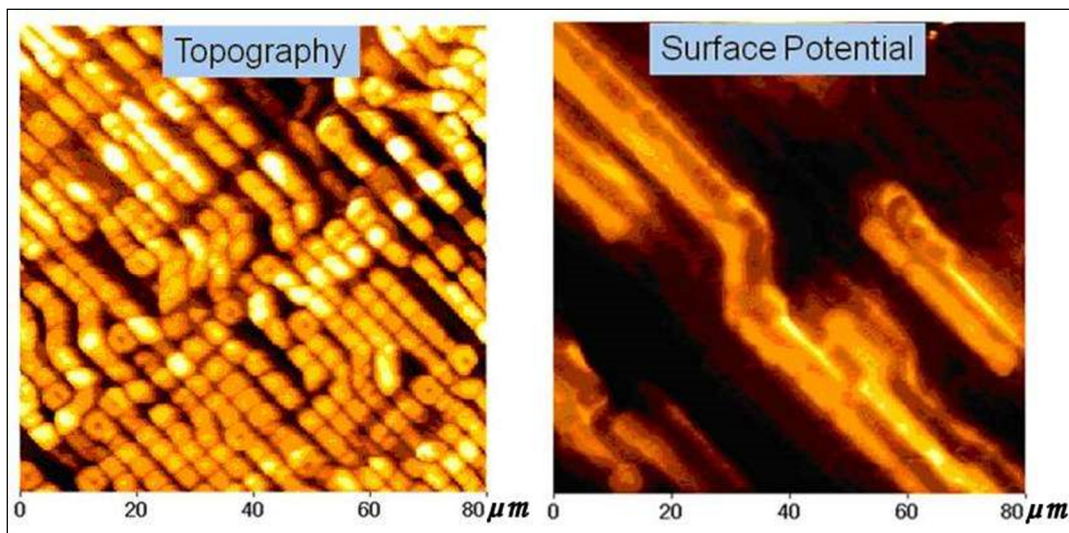

*Topography (AFM) and Surface Potential distribution (EFM) on an ASIC “Application-Specific Integrated Circuit” = microelectronics device. Source Park systems*

<http://www.parkafm.com>

## Atomic Force Microscopy - Applications

### ➤ Applications.

Wide application domain from microelectronics to biology. High spatial resolution direct imaging of any surface whatever its conductive characteristics: metals, semi-conductors and **insulators**.

### ➤ Topographic investigations.

.Metrology of surfaces AFM, LFM:

Computer science industry (CD, DVD, HDD...),

Microelectronic industry (quality control of masks...),

Optical industry (quality control of optical surfaces...),

Pharmaceutical industry, biotechnology (in vitro investigation of biological molecules, bacteria...)

Construction industry (coating, paintings...)

Automotive industry (anti-corrosion coatings, paintings...)

Fundamental research: physics, chemistry, biology...

...

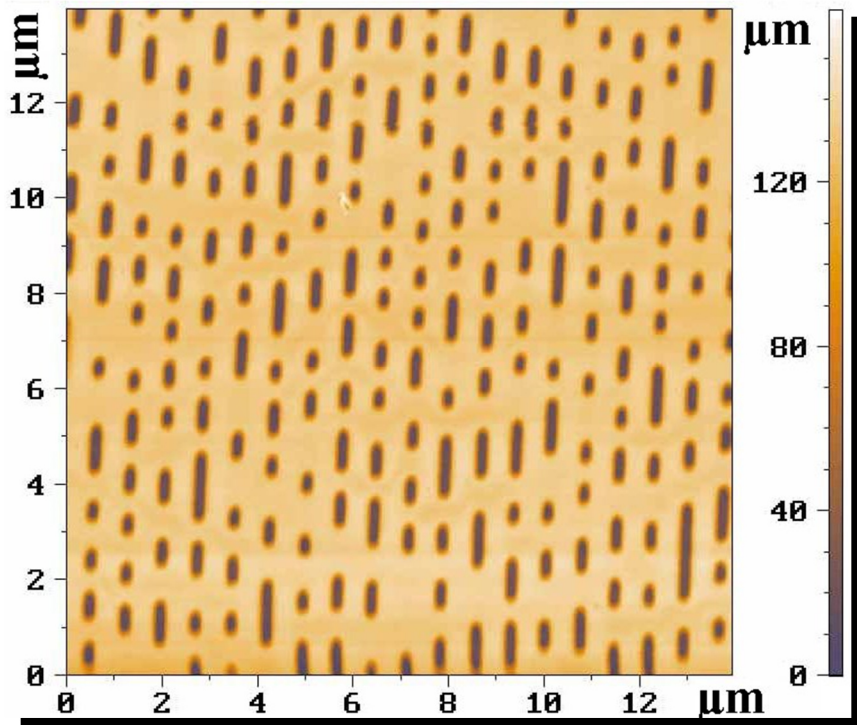

Surface of a DVD (Digital Versatile Disk)

AFM topography,  
Non contact mode,  
14 x 14 μm<sup>2</sup>.

*Sergey Lemeshko,  
NT-MDT, Russia.*

### ➤ Microfabrication, nanolithography...

## Atomic Force Microscopy - Applications

### ➤ Physical and chemical properties.

.**Mechanical properties** AFM, LFM: adhesion, tribological effects...

#### .**Magnetic properties MFM:**

Computer science industry (magnetic storage, magneto-optic disk, hard disk drive platters, magneto-resistive heads...),

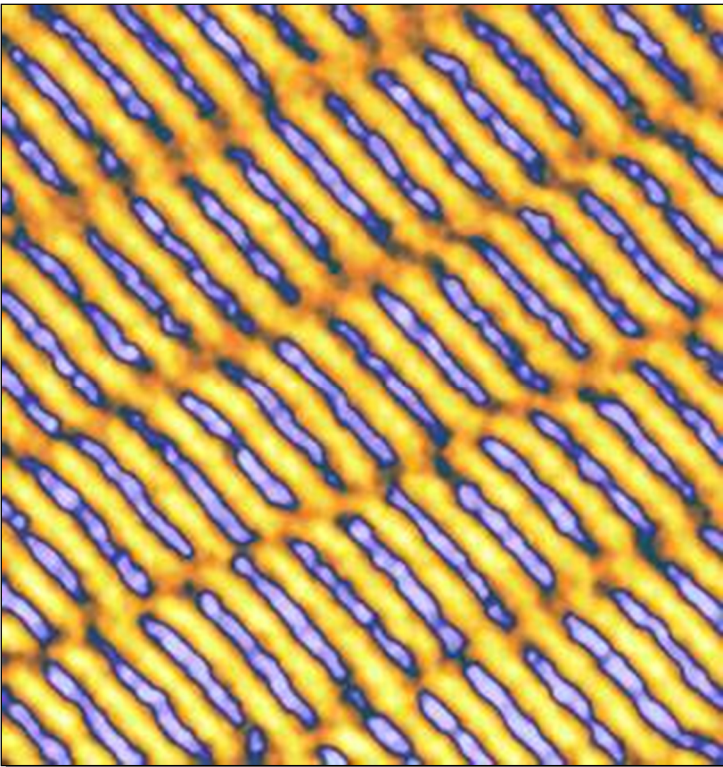

*High density HDD.  $2.5 \times 2.5 \mu\text{m}^2$  MFM image of high density (40 Gb) hard disk drive. Distance between magnetic bits is about 200 nm. (soft cantilever with permalloy coating.)*

Source <http://www.ntmdt-america.com>

Pharmaceutical industry, biotechnology (magnetotactic bacteria)  
Fundamental research: physics, geophysics (rock magnetism...)

#### .**Electric properties EFM:**

Microelectronic industry (dopant distribution, **failure analysis tool of microelectronic devices**...)

Fundamental research in physics, chemistry...

<b>Force type</b>	<b>Mode</b>	<b>Information</b>	<b>Name</b>	<b><math>\Delta r_x</math> (nm)</b>
Repulsive force, normal component	Contact	Topography, Force spectrometry	AFM	$\geq 1$
Repulsive force, lateral component	Contact	Topography, Composition, Nanotribology...	LFM	$\geq 1$
Attractive force, force gradient	Non contact, Intermittent contact	Topography (soft samples)	DFM AFM	$\geq 0.1$ $\geq 1$
Magnetic force, Force gradient	Non contact, Lift <sup>TM</sup>	Mapping of the magnetic topography (domain walls)	MFM	$\geq 10$
Electrostatic force, Force gradient	Non contact, Lift <sup>TM</sup>	Mapping of the electrostatic force, the surface potential	EFM SP	$\geq 10$

<b>Force type</b>	<b>Mode</b>	<b>Measure principle</b>	<b>Nom</b>	<b><math>\Delta r_x</math> (nm)</b>
Repulsive force, normal component	Contact. Static	Cantilever deflection	AFM	$\geq 1$
Repulsive force, lateral component	Contact. Static	Cantilever torsional deflection (twisting)	LFM	$\geq 1$
Attractive force, force gradient	Intermittent contact (Tapping <sup>TM</sup> ). Dynamic.	Forced oscillations of the cantilever, shift of the resonance frequency $\Delta\nu$ , resp. amplitude $\Delta A$ .	AFM	$\geq 1$
Attractive force, force gradient	Non contact, dynamic mode	Forced oscillations of the cantilever, shift of the resonance frequency $\Delta\nu$ , resp. amplitude $\Delta A$ .	AFM DFM	$\geq 0.1$
Magnetic, resp. electrostatic force, Force gradient	Lift	1) first pass: contact mode cantilever deflection, 2) Second pass: dynamic mode	MFM EFM SP	$\geq 10$

## Atomic Force microscopy – References & Resources.

### ➤ Bibliographic resources.

.Microscopie à sonde locale, Techniques de l'Ingénieur, Traité Analyse et Caractérisation P 895, F. Salvan, F. Thibaudau,

.Scanning Tunneling Microscopy Vol. I, II, III, R. Wiesendanger, H.-J. Güntherodt, Springer series in surface science (1992, 1993, 1995),

.Surface analysis with STM and AFM, S.N. Magonov, VCH Publishers (1996),

.Scanning Tunneling Microscopy and its Applications par C. Bai, 2<sup>nd</sup> revised edition, Springer series in surface science, Shanghai Scientific & Technical publishers (2000),

### ➤ Internet resources (commercial).

Techniques de l'Ingénieur [www.techniques-ingenieur.fr](http://www.techniques-ingenieur.fr)

AFM WorkShop [www.afmworkshop.com/](http://www.afmworkshop.com/),

Asylum Research [www.asylumresearch.com](http://www.asylumresearch.com),

Bruker AXS (**Digital Instruments**) [www.bruker-axs.de](http://www.bruker-axs.de),

CSI [www.csinstruments.eu](http://www.csinstruments.eu),

DME - Danish Micro Engineering [www.dme-spm.dk](http://www.dme-spm.dk),

JPK Instruments [www.jpk.com](http://www.jpk.com),

Keysight technologies (Agilent Tech.) [www.keysight.com](http://www.keysight.com),

Nanonics Imaging Ltd [www.nanonics.co.il](http://www.nanonics.co.il),

NanoSurf AG [www.nanosurf.com](http://www.nanosurf.com),

NovaScan [www.novascan.com](http://www.novascan.com),

NT-MDT [www.ntmdt.ru](http://www.ntmdt.ru),

Omicron GmbH [www.omicron.de](http://www.omicron.de),

Park Systems [www.parkafm.com/](http://www.parkafm.com/),

RHK Technology Inc. [www.rhk-tech.com](http://www.rhk-tech.com),

Triple-O [www.triple-o.de](http://www.triple-o.de),

Witec [witec.de](http://witec.de)

## Atomic Force Microscopy - Contact mode.

In **contact mode**, the tip contacts on the surface (in the classical physics sense) and probes short range repulsive forces (Born - Pauli forces) = **repulsive imaging mode**.

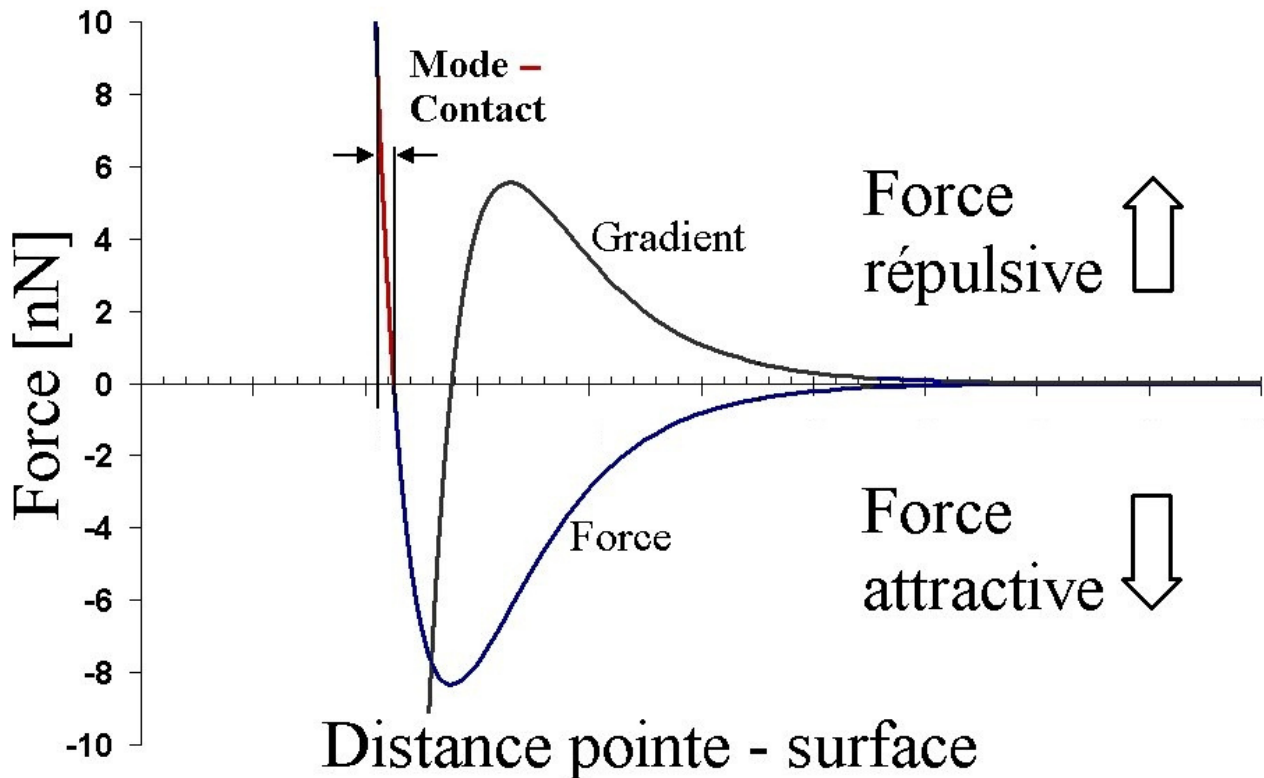

Force range	$1 \cdot 10^{-9} \text{ N} \leq F_{\text{contact}} \leq 1 \cdot 10^{-7} \text{ N}$ ,
Short tip-to-surface distances $d$	$d \leq 0.3 \text{ nm} = 3 \text{ \AA}$ ,
Normal topographic resolution	$\Delta r_z \geq 0.01 \text{ nm} = 0.1 \text{ \AA}$ ,
In-plane topographic resolution	$\Delta r_x \geq 1 \text{ nm} = 10 \text{ \AA}$ .

## Atomic Force Microscopy - Non contact dynamic mode.

In **non-contact mode**, the tip-surface interactions are extremely weak (no true contact in the classic sense), mainly **attractive** and **long-range** in nature.

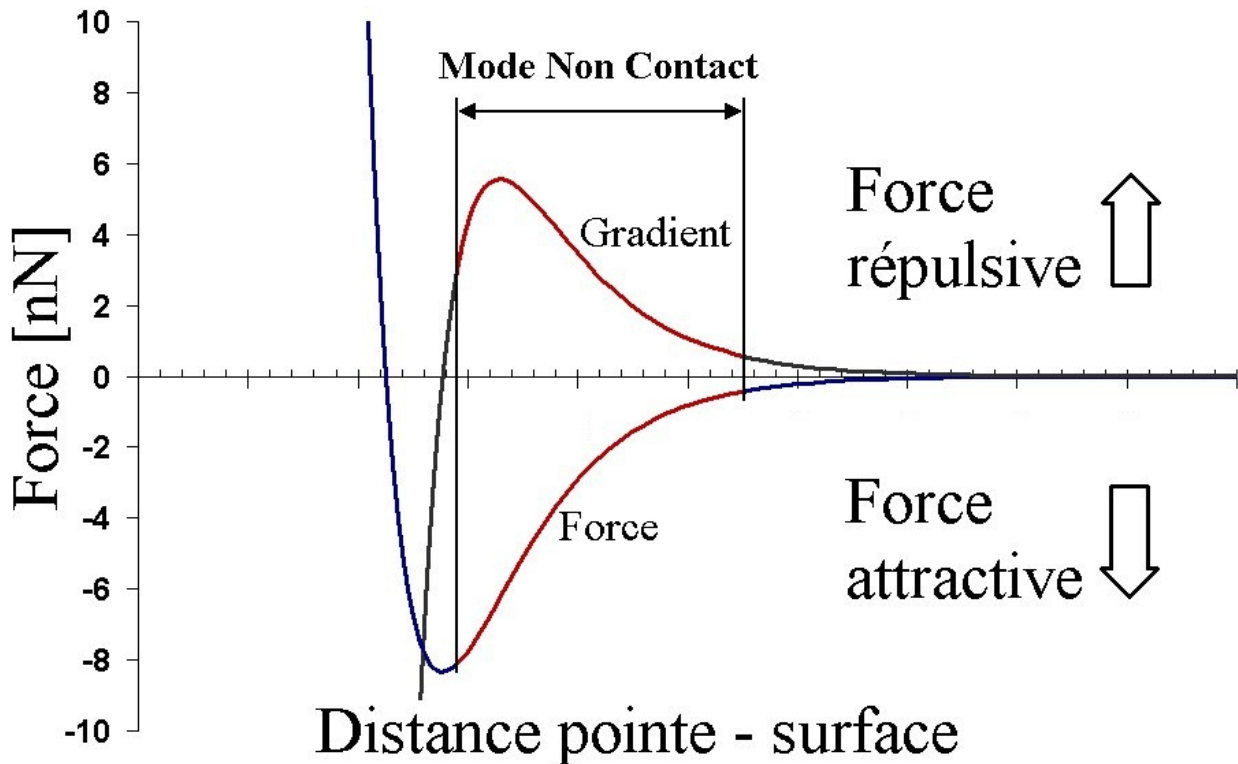

Force range

Large tip-surface distance

Normal topographic resolution

In-plane topographic resolution

$$1 \cdot 10^{-15} \text{ N} \leq F_{\text{contact}} \leq 1 \cdot 10^{-10} \text{ N},$$

$$d \geq 0.3 \text{ nm} = 3 \text{ \AA},$$

$$\Delta r_z \geq 0.01 \text{ nm} = 0.1 \text{ \AA},$$

$$\Delta r_x \geq 0.1 \text{ nm} = 1 \text{ \AA},$$

**Atomic resolution is possible.**

## Microscopie à force atomique.

- Principe. - G. Binnig, C.F. Quate, Ch. Gerber, *Phys. Rev. Lett.* **56**, 930, (1986).
- Nature des forces.
  - .Forces de répulsion à courte portée.
  - .Force de Van der Waals - London.
  - .Force électrostatique.
  - .Force magnétique.
- Nature des forces - modifications de l'environnement pointe-surface.
  - .Force de capillarité.
- Ordre de grandeur des forces répulsives de contact.
- Ordre de grandeur des forces attractives de Van der Waals.
- Modes de fonctionnement d'un microscope à force atomique.
- Microscopie à force atomique - Mode contact.
- Principe d'imagerie à *Force constante (isoforce)*.
- Mise en œuvre de la microscopie à force atomique.
  - .Préparation du système levier-pointe (cantilever)
  - .Mesure de la déflexion du levier.
    - .Méthode tunnel.
    - .Réflexion optique d'un faisceau laser.
    - .Interférométrie.
    - .Méthode piézoélectrique.
    - .Méthode capacitive.
- Microscopie à force atomique - Mode non contact vibrant.
- Principe d'imagerie à *Gradient de Force Constant*.
- Principe de la détection de gradient de force - Cas  $\Delta A \ll d$ .
- Principe de la détection de gradient de force.
- Imagerie AFM à haute résolution (DFM).
- Mode contact intermittent (tapping mode<sup>TM</sup>).
- Modes d'imagerie courants.
  - .Mode isoforce (force constante).
  - .Mode à hauteur constante.
  - .Mode isogradient de force.



## Microscopie à force atomique.

### *.Mode spectrométrique.*

- **Magnetic Force Microscopy MFM.** Y. Martin, H.K. Wickramasinghe, *Appl. Phys. Lett.* **50**, 1455 (1987).

### *.Mode Lift<sup>TM</sup>.*

- **Lateral Force Microscopy LFM.**
- **Electrostatique Force Microscopy EFM.**
- **Surface Potential (SP) Imaging - Variante EFM.**
- **Applications.**
  - Etudes topographiques.
  - Etude des propriétés physico-chimiques.
- **Références bibliographiques.**
- **Ressources internet (commerciales).**