



**HAL**  
open science

## High rejection self-oscillating up-conversion mixer for fifth-generation communications

Abdelhafid Es-Saqy, Maryam Abata, Mohammed Fattah, Said Mazer, Mahmoud Mehdi, Moulhime El Bekkali, Catherine Algani

► **To cite this version:**

Abdelhafid Es-Saqy, Maryam Abata, Mohammed Fattah, Said Mazer, Mahmoud Mehdi, et al.. High rejection self-oscillating up-conversion mixer for fifth-generation communications. International Journal of Electrical and Computer Engineering, 2023, 13 (5), pp.4979. 10.11591/ijece.v13i5.pp4979-4986 . hal-04487161

**HAL Id: hal-04487161**

**<https://hal.science/hal-04487161>**

Submitted on 18 Jul 2024

**HAL** is a multi-disciplinary open access archive for the deposit and dissemination of scientific research documents, whether they are published or not. The documents may come from teaching and research institutions in France or abroad, or from public or private research centers.

L'archive ouverte pluridisciplinaire **HAL**, est destinée au dépôt et à la diffusion de documents scientifiques de niveau recherche, publiés ou non, émanant des établissements d'enseignement et de recherche français ou étrangers, des laboratoires publics ou privés.



Distributed under a Creative Commons Attribution - ShareAlike 4.0 International License

# High rejection self-oscillating up-conversion mixer for fifth-generation communications

Abdelhafid Es-saqy<sup>1</sup>, Maryam Abata<sup>1</sup>, Mohammed Fattah<sup>2</sup>, Said Mazer<sup>1</sup>, Mahmoud Mehdi<sup>3</sup>,  
Moulhime El Bekkali<sup>1</sup>, Catherine Algani<sup>4</sup>

<sup>1</sup>AIDSES Laboratory, ENSA, Sidi Mohamed Ben Abdellah University, Fez, Morocco

<sup>2</sup>IMAGE Laboratory, EST, Moulay Ismail University, Meknes, Morocco

<sup>3</sup>Microwaves Laboratory, Lebanese University, Beirut, Lebanon

<sup>4</sup>ESYCOM Laboratory, Université Gustave Eiffel, CNRS, Paris, France

## Article Info

### Article history:

Received Oct 3, 2022

Revised Apr 7, 2023

Accepted Apr 7, 2023

### Keywords:

Fifth-generation circuits

Mixer

Mm-Wave

Self-oscillating mixer

Up-conversion

## ABSTRACT

This paper presents the design of a pseudomorphic high electron mobility transistor (pHEMT) self-oscillating mixer (SOM) for millimeter wave wireless communication systems. The 180° out-of-phase technique is chosen to both improve the desired lower sideband (LSB) signal and to achieve a satisfactory rejection of the unwanted signals (LO, USB and IF). This SOM is designed on the PH15 process of UMS foundry which is based on 0.15 μm GaAs pHEMT. The signal is up-converted from 2 GHz-IF frequency to 26 GHz-LSB frequency, using an autogenerated 28 GHz-LO signal. Simulations were performed using the advanced design system (ADS) workflow. They show 6.4 dB conversion gain and a signal rejection rate of 29.7 dB for the unwanted USB signal. the chip size is 3.6 mm<sup>2</sup>.

This is an open access article under the [CC BY-SA](https://creativecommons.org/licenses/by-sa/4.0/) license.



## Corresponding Author:

Abdelhafid Es-Saqy

AIDSES Laboratory, Sidi Mohamed Ben Abdellah University

Fez, Morocco

Email: abdelhafid.essaqy@usmba.ac.ma

## 1. INTRODUCTION

In these times of pandemic caused by coronavirus disease 2019 (COVID-19), communities' way of life has been changed [1]. During social distancing, connectivity allows us to keep informed, continue working and maintain our mental and physical health balance [2]. As current communication systems cannot meet our needs, developing new communication systems for fifth-generation (5G) has become a great necessity [3]–[5]. And to achieve the performance promised by this new generation, new design approaches and semiconductor technologies are being adopted.

Radio frequency (RF) transceivers must be as compact as possible to effectively reduce power consumption in 5G millimeter-wave systems [6]. High integration also leads to a tangible reduction in the costs of semiconductor technologies [7], [8]. In this context, the research presented in Winkler *et al.* [8] and Lee *et al.* [9] is carried out. They propose the design of self-oscillating mixer (SOM) circuit, which combines the harmonic generation, and the frequency conversion functions in a single RF chip.

Sawada and Imai [10] propose the design of an optoelectronic self-oscillating using a heterojunction bipolar transistor (HBT). The designed circuit performs the up-conversion of the 1 GHz-IF signal to a 10.6 GHz-RF signal, using a 9.6 GHz LO. On the other hand, low-power injection-locked zero-IF SOM for 40 GHz-RF frequency is developed in Burasa *et al.* [11]. The experimental results exhibit a conversion gain of -30 dB under -38 dBm input power. An up-conversion SOM for 77 GHz applications is presented in the paper [9]. This circuit has a high conversion gain of 3.87 dB. However, both lower sideband (LSB) and universal

serial bus (USB) signals have the same output power, meaning no image frequency rejection exists. In [8], an integrated receiver using a balanced SOM for 5.8 GHz-RF frequency is presented.

The purpose of this paper is to analyze and design a SOM circuit. It consists of a low-phase noise voltage controlled oscillator (VCO) and a double-balanced mixer with high LO and USB signal rejections. The mixer circuit, introducing couplers and phase-shifting lines, allows a conversion gain of 6.385 dB. Thus, among published SOMs, this work exhibits the best GC around 26 GHz, with a high rejection of unwanted harmonics, making it more attractive for 5G wireless systems.

This paper is organized as follows. The pseudomorphic high electron mobility transistor (pHEMT) is introduced in section 2. In section 3, the double-balanced mixer architecture is studied and designed. While in section 4, the designed SOM circuit and its simulation results are discussed. Then a conclusion is reported in section 5.

## 2. PHEMT TECHNOLOGY

There is explosive growth in mobile traffic demand, broadband transmissions and improved system performances are required [12]–[14]. Circuit designers are then focused on the device technology [15]: transistors with high transducer gain and low noise are privileged in our study. GaAs pHEMTs are nowadays the basis for monolithic microwave integrated circuits (MMIC) circuits [16]. Thanks to the development of these SC devices, researchers have succeeded in designing very efficient communication systems for the next generation 5G [17]–[24].

The circuit presented in this paper is designed with a 0.15  $\mu\text{m}$  GaAs pHEMT transistor from the UMS foundry. A cutoff frequency characterizes this device  $f_T$  of 110 GHz, a maximum transconductance  $g_m$  of 640 (mS)/mm, a maximum  $I_{ds}$  current of 220 mA/mm, a pinch-off voltage  $V_{pinch}$  of -0.7 V, and a gate-drain breakdown voltage of more than 4.5 V [25]. The transistor gate length is 0.15  $\mu\text{m}$ , associated with a gate width of 30  $\mu\text{m}$ . The pHEMT structure is shown in Figure 1. The typical electrical parameters of the used pHEMT are summarized in Table 1.

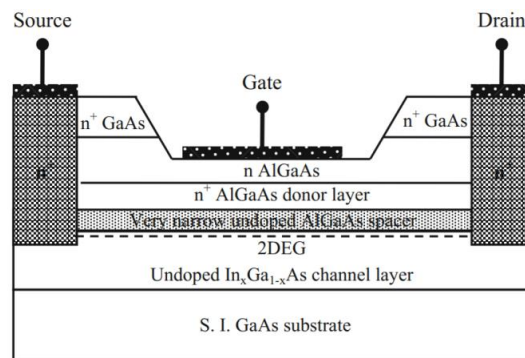

Figure 1. Structure of the pHEMT Technology [26]

Table 1. Typical electrical parameters of the pHEMT technology

Parameters	Values
Power density	300 mW/mm
Gate length	0.15 $\mu\text{m}$
$I_{dssat}$	220 mA/mm
$V_{BDS}$	> 4.5 V
Cutoff frequency	110 GHz
pinch-off voltage	- 0.7 V
$G_m$ max	640 ms/mm
Noise/Gain	1.9/6 dB @ 60 GHz

## 3. DOUBLE BALANCED MIXER DESIGN

### 3.1. Proposed architecture

LO, IF, and USB rejections are performed by filtering, in the case of a carrier frequency in a few hundred MHz, or by the method of phase opposition, especially for a carrier frequency in the millimeter-wave band, where filtering becomes difficult because of the impedance matching difference at the different ports of

a balanced structure and in a large bandwidth. Two input signals that are phase opposite and with the same amplitude cancel each other at the output when added.

As shown in Figure 2, the signals LO1, LO2, LO3, and LO4, successively shifted in phase by 90°, drive the four transistor gates of four cascode cells acting as mixer cells. The other four transistor gates are excited by the signals IF1, IF2, IF3, and IF4, successively phase shifted by 90°, to. Table 2 presents the phase balance of the main signals present at each output of the four cascode cells, corresponding to transistor drains. Vector addition of the signals RF1, RF2, RF3 and RF4, leads to eliminating the signals in the opposite phase, i.e., IF, LO, and USB, while it amplifies the LSB signal in the millimeter-waves for 5G.

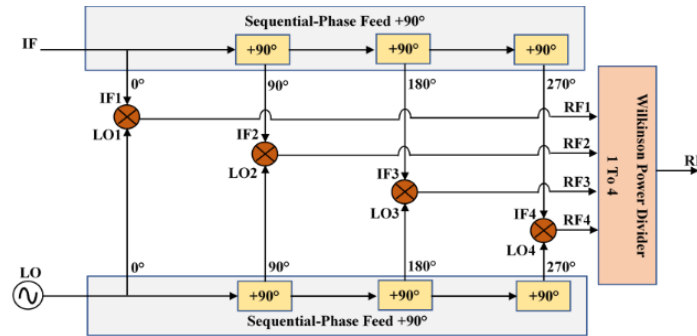

Figure 2. Synoptic diagram of the proposed double balanced mixer

Table 2. Phase balance of the signals present on the drains of the four cascode cells

Output	Signal			
	FI	OL	LSB	USB
RF1	0°	0°	0°	0°
RF2	90°	90°	0°	180°
RF3	180°	180°	0°	0°
RF4	270°	270°	0°	180°

### 3.2. Post-layout simulations

The mixer presented in this paper can generate RF signal in the first millimeter-wave band assigned to 5G by the International Telecommunication Union (from 24.25 to 27.5 GHz). Figure 3 shows the conversion gain CG as a function of LO frequency, varying from 26.25 to 29.5 GHz. CG is positive and higher than 2 dB. In addition, to verify the harmonic rejection at IF, LO, and USB frequencies, its output power spectrum is presented in Figure 4. In the LO frequency bandwidth, the mixer has a good level of rejection. The rejection of the USB signal is maximum and about 25 dB for a LO frequency of 28.25 GHz. And the rejection of the IF signal exceeds 30 dB in the LO bandwidth. At 27.4 GHz-LO frequency, the LO rejection reaches its maximum value of 15 dB at the mixer output, and it decreases for the other frequencies, higher than 4 dB for the worst case.

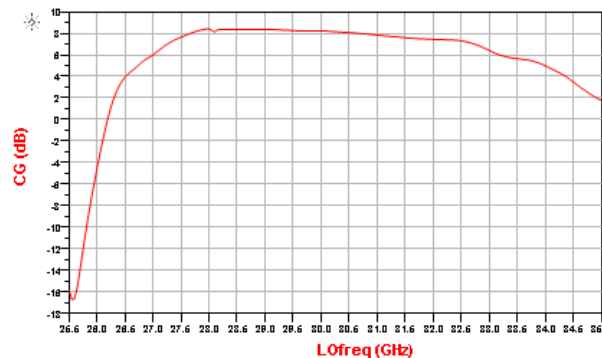

Figure 3. Variation of the conversion gain versus LO frequency (for IF\_power=-11.5 dBm and LO\_power=7.5 dBm and IF\_freq=2 GHz)

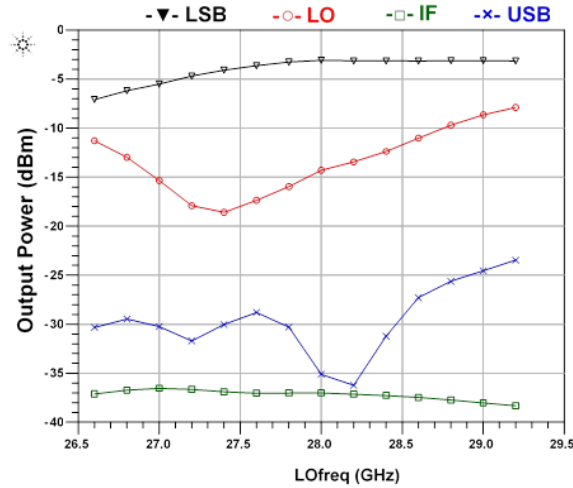

Figure 4. Variation of IF, LO, USB and LSB power versus LO frequency (for IF\_power=-11.5 dBm and LO\_power=7.5 dBm and IF\_freq=2 GHz)

The same frequency analysis was performed, varying the IF frequency. Figure 5 shows the CG curve versus IF frequency. It shows a conversion gain ripple of 3 dB for an IF frequency variation of 100 MHz (between 1.95 and 2.05 GHz). The output power spectrum is presented in Figure 6, showing a good rejection all over the IF frequency band: IF signal rejection is higher than 30 dB, the maximum USB rejection is 22 dB, whereas its minimum value is 5 dB, and finally, the LO rejection varies from 8 to 32 dB.

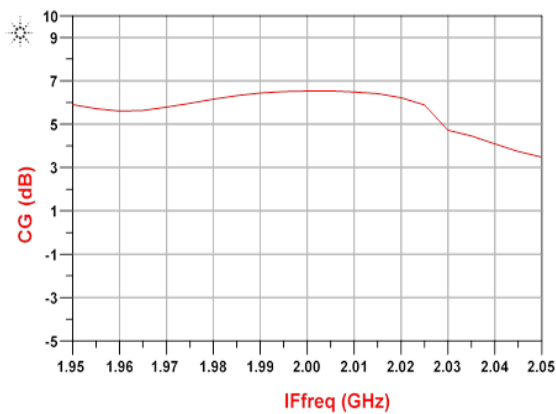

Figure 5. Variation of the conversion gain versus IF frequency (for IF\_power=-11.5 dBm and LO\_power=7.5 dBm and LO\_freq=27 GHz)

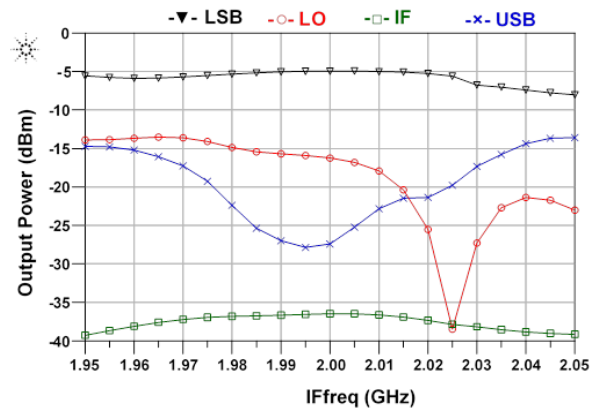

Figure 6. Variation of IF, LO, USB and LSB power versus IF frequency (for IF\_power=-11.5 dBm and LO\_power=7.5 dBm and LO\_freq=27 GHz)

#### 4. SELF-OSCILLATING MIXER DESIGN

##### 4.1. Layout design

To ensure the LO signal generation and the IF signal conversion inside the same circuit, we integrate the mixer circuit into a VCO. Figure 7 illustrates the process of this integration. Figure 7(a) shows the LO and Mixer blocks before the integration and Figure 7(b) shows the resulting SOM block. The VCO circuit has been presented and studied in detail in the paper [25]. It is a perfectly symmetrical circuit based on “pHEMT varactor” to vary the capacitance value of the resonator and thus control the oscillation frequency.

The layout of the SOM circuit is presented in Figure 8. Its area dimension is 3.6 mm<sup>2</sup>. It consists of the doubly balanced mixer (Part I), the VCO whose oscillation frequency is controlled by the control voltage V<sub>tune</sub> (Part II), and the impedance matching circuit (Part III). The matching circuits are provided to achieve impedance matching between the output of the VCO and the LO port of the mixer.

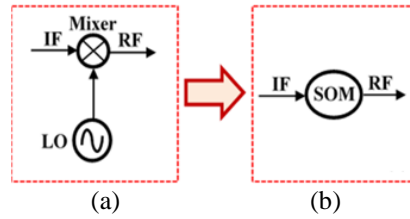

Figure 7. LO and Mixer blocks (a) before integration and (b) after integration

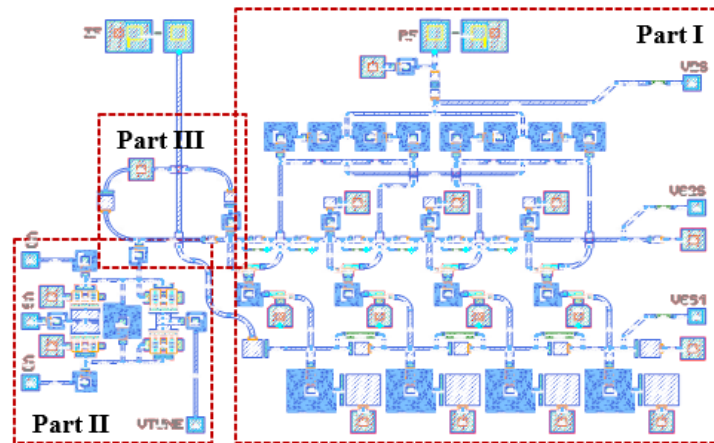

Figure 8. 5G mm-wave SOM layout

**4.2. Post-layout simulations**

The conversion gain of the SOM circuit is presented in Figure 9. For an IF power of -15.4 dBm, the CG equals 6.385 dB. On the other hand, the variation of the LSB output power is presented in Figure 10. For an IF power of -12.5 dBm, it is equal to -7.394 dBm.

To verify the rejection of IF, LO and USB harmonics, the Figure 11 presents the power spectrum at the SOM output. In the LO frequency bandwidth, the SOM has a good level of rejection. The rejection of LO signal is better than 8 dB in the entire bandwidth. In addition, the rejection of IF signal exceeds 22 dB. And the USB rejection reaches its maximum value of 29.7 dB for a voltage  $V_{tune}$  lower than 1 V. Whereas it is about 20 dB for the other values of  $V_{tune}$ . Finally, the effect of technological dispersion is evaluated. Figure 12 shows the Monte Carlo analysis of IF, LO, USB and LSB signals. This analysis is performed at 100 iterations.

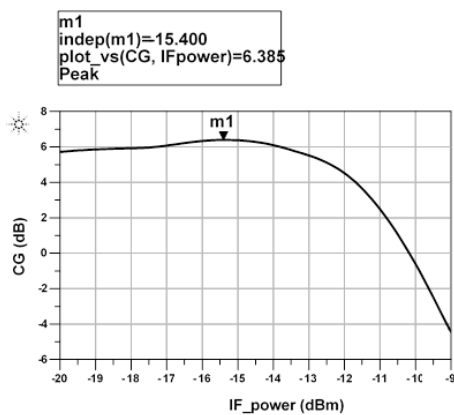

Figure 9. Variation of the conversion gain versus IF power (for IF\_frequ=2 GHz, and LO\_power=7.5 dBm and  $V_{tune}=0.8$  V)

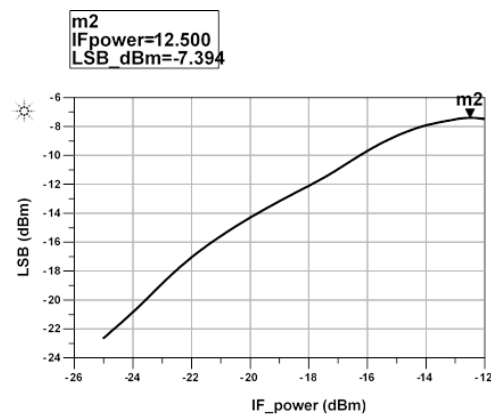

Figure 10. LSB power versus IF power (for IF\_frequ=2 GHz, and LO\_power=7.5 dBm and  $v_{tune}=0.8$  V)

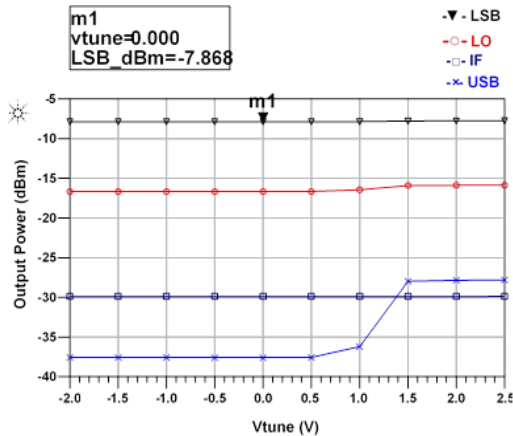

Figure 11. Variation of IF, LO, USB and LSB power versus vtune (for IF\_power=-11.5 dBm and IFfreq=2 GHz)

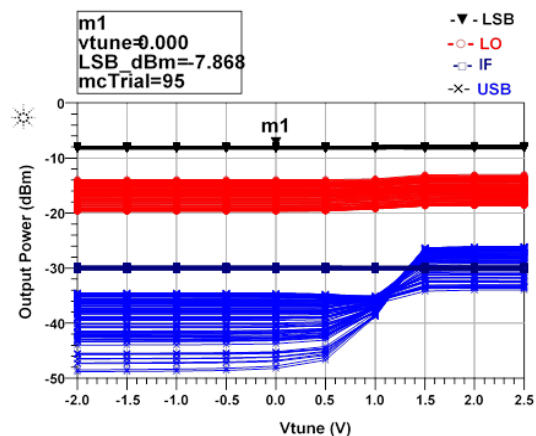

Figure 12. Monte Carlo analysis of IF, LO, USB and LSB power (for IF\_power=-11.5 dBm and IFfreq=2 GHz)

Table 3 summarizes the main characteristic parameters of SOMs published in the literature. The conversion gain of our SOM is 6.385 dB which is greater than the one of the structures studied in [9], [11], [27], [28]. In addition, our circuit allows high rejection of unwanted harmonics at its output. This allows to eliminate IF, LO and USB harmonics without the use of a bandpass filter. Therefore, this circuit meets the requirements of the new communication systems.

Table 3. Performance summary and comparison of SOMs

	Technology	RF freq (GHz)	IF freq (GHz)	CG (dB)	Chip size (mm <sup>2</sup> )
This work	0.15 $\mu$ m GaAs pHEMT	26	2	6.385	3.6
[11]	65 nm CMOS	40	NA	-30	0.24
[27]	0.13 $\mu$ m CMOS	30	0.5	-30	NA
[9]	0.10 $\mu$ m GaAs pHEMT	38.5/77.38	0.3	3.87	5.98
[28]	0.20 $\mu$ m GaAs pHEMT	10	1.57	-19	NA

## 5. CONCLUSION

New design approaches are needed to achieve the performance promised by 5G, which relies on millimeter wave frequencies. This paper shows the efficiency and feasibility of an up-conversion SOM with IF, LO, and USB rejection for 5G millimeter-wave systems. The circuit enables up-conversion of a 2 GHz IF signal to a 26 GHz LSB signal. The circuit has a conversion gain of 6.385 dB. The rejection of the LO signal is better than 8 dB in the entire bandwidth. In addition, the rejection of IF signal exceeds 22 dB. And the USB rejection reaches a maximum value of 29.7 dB. The circuit layout occupies an area of 3.6 mm<sup>2</sup>; it is designed based on 0.15  $\mu$ m GaAs pHEMT of PH15 process from UMS foundry. This circuit will constitute the core of a fully integrated communication system that we intend to design based on pHEMT Technology.



## REFERENCES

- [1] Y. Siriwardhana, C. De Alwis, G. Gur, M. Ylianttila, and M. Liyanage, "The fight against the COVID-19 pandemic with 5G technologies," *IEEE Engineering Management Review*, vol. 48, no. 3, pp. 72–84, Sep. 2020, doi: 10.1109/EMR.2020.3017451.
- [2] R. Pratap Singh, M. Javaid, A. Haleem, R. Vaishya, and S. Ali, "Internet of medical things (IoMT) for orthopaedic in COVID-19 pandemic: Roles, challenges, and applications," *Journal of Clinical Orthopaedics and Trauma*, vol. 11, no. 4, pp. 713–717, Jul. 2020, doi: 10.1016/j.jcot.2020.05.011.
- [3] J. A. Aldhaibani, Y. Naser Jurn, and N. Ibrahim Abdulkhaleq, "Performance evaluation of dual backhaul links RF/FSO for small cells of 5G cellular system," *International Journal of Electrical and Computer Engineering (IJECE)*, vol. 12, no. 4, pp. 3922–3931, Aug. 2022, doi: 10.11591/ijece.v12i4.pp3922-3931.
- [4] S.-E. Chafi, Y. Balboul, S. Mazer, M. Fattah, and M. El Bekkali, "Resource placement strategy optimization for smart grid application using 5G wireless networks," *International Journal of Electrical and Computer Engineering (IJECE)*, vol. 12, no. 4, pp. 3932–3942, Aug. 2022, doi: 10.11591/ijece.v12i4.pp3932-3942.
- [5] M. A. Waheed, A. B. Saeed, and T. H. Abd, "Signalling load reduction in 5G network based on cloud radio access network architecture," *International Journal of Electrical and Computer Engineering (IJECE)*, vol. 11, no. 6, pp. 5127–5136, Dec. 2021, doi: 10.11591/ijece.v11i6.pp5127-5136.

- [6] E. Gures, I. Shayea, A. Alhammadi, M. Ergen, and H. Mohamad, "A comprehensive survey on mobility management in 5G heterogeneous networks: Architectures, challenges and solutions," *IEEE Access*, vol. 8, pp. 195883–195913, 2020, doi: 10.1109/ACCESS.2020.3030762.
- [7] S. E. Gunnarsson *et al.*, "Highly integrated 60 GHz transmitter and receiver MMICs in a GaAs pHEMT technology," *IEEE Journal of Solid-State Circuits*, vol. 40, no. 11, pp. 2174–2186, Nov. 2005, doi: 10.1109/JSSC.2005.857366.
- [8] S. A. Winkler, K. Wu, and A. Stelzer, "Integrated receiver based on a high-order subharmonic self-oscillating mixer," *IEEE Transactions on Microwave Theory and Techniques*, vol. 55, no. 6, pp. 1398–1404, Jun. 2007, doi: 10.1109/TMTT.2007.896775.
- [9] S.-J. Lee, W. Uhm, S. Choi, K.-K. Ryu, and S.-C. Kim, "A self-oscillating mixer with double-conversion structure for 77 GHz applications," *Microwave and Optical Technology Letters*, vol. 58, no. 8, pp. 1989–1993, Aug. 2016, doi: 10.1002/mop.29962.
- [10] H. Sawada and N. Imai, "A self-oscillating optoelectronic up-converter using a heterojunction bipolar transistor up to millimeter-wave bands," in *International Topical Meeting on Microwave Photonics. MWP '96 Technical Digest. Satellite Workshop (Cat. No. 96TH8153)*, 1996, pp. 153–156. doi: 10.1109/MWP.1996.662093.
- [11] P. Burasa, N. G. Constantin, and K. Wu, "Low-power injection-locked zero-if self-oscillating mixer for high Gbit/s data-rate battery-free active tag at millimeter-wave frequencies in 65-nm CMOS," *IEEE Transactions on Microwave Theory and Techniques*, vol. 64, no. 4, pp. 1055–1065, Apr. 2016, doi: 10.1109/TMTT.2016.2530717.
- [12] A. Mamane, M. Fattah, M. El Ghazi, and M. El Bekkali, "5G enhanced mobile broadband multi-criteria scheduler for dense urban scenario," *Telecommunication Systems*, vol. 80, no. 1, pp. 33–43, May 2022, doi: 10.1007/s11235-022-00885-3.
- [13] S.-E. Didi *et al.*, "New microstrip patch antenna array design at 28 GHz millimeter-wave for fifth-generation application," *International Journal of Electrical and Computer Engineering (IJECE)*, vol. 13, no. 4, pp. 4184–4193, Aug. 2023, doi: 10.11591/ijece.v13i4.pp4184-4193.
- [14] A. El Krouk, A. Es-Saqy, M. Fattah, S. Mazer, M. El Bekkali, and M. Mehdi, "Gilbert cell down-conversion mixer for THz wireless communication," in *Proceedings of the Artificial Intelligence and Smart Environment. ICAISE*, 2023, pp. 475–480. doi: 10.1007/978-3-031-26254-8\_68.
- [15] A. Farti and A. Touhami, "Thermal model developed of high electron mobility transistor AlGaIn-GaN," *Indonesian Journal of Electrical Engineering and Computer Science (IJECS)*, vol. 26, no. 2, pp. 689–698, 2022, doi: 10.11591/ijeecs.v26.i2.pp689-698.
- [16] Z. Wang *et al.*, "A 37-GHz asymmetric doherty power amplifier with 28-dBm P sat and 32% back-off PAE in 0.1- $\mu$ m GaAs process," *IEEE Transactions on Microwave Theory and Techniques*, vol. 70, no. 2, pp. 1391–1400, Feb. 2022, doi: 10.1109/TMTT.2021.3136510.
- [17] M. Sajedin, I. Elfergani, J. Rodriguez, R. Abd-Alhameed, M. Fernandez-Barciela, and M. Violas, "Ultra-compact mm-Wave monolithic IC doherty power amplifier for mobile handsets," *Electronics*, vol. 10, no. 17, Sep. 2021, doi: 10.3390/electronics10172131.
- [18] H. Xie, Y. J. Cheng, Y. R. Ding, L. Wang, and Y. Fan, "A high-efficiency 28 GHz/39 GHz dual-band power amplifier MMIC for 5G communication," *IEEE Microwave and Wireless Components Letters*, vol. 31, no. 11, pp. 1227–1230, Nov. 2021, doi: 10.1109/LMWC.2021.3095659.
- [19] Y. Chen, C.-N. Chen, C.-C. Chiong, and H. Wang, "A compact 40-GHz doherty power amplifier with 21% PAE at 6-dB power back off in 0.1- $\mu$ m GaAs pHEMT process," *IEEE Microwave and Wireless Components Letters*, vol. 29, no. 8, pp. 545–547, Aug. 2019, doi: 10.1109/LMWC.2019.2925716.
- [20] C. Wang, D. Hou, J. Chen, and W. Hong, "A dual-band switchable MMIC star mixer," *IEEE Microwave and Wireless Components Letters*, vol. 29, no. 11, pp. 737–740, Nov. 2019, doi: 10.1109/LMWC.2019.2940637.
- [21] H. D. Lee, S. Kong, B. Park, K. C. Lee, J.-S. Park, and J.-G. Kim, "A 28-GHz 28.5-dBm power amplifier using 0.15- $\mu$ m InGaAs E-mode pHEMT technology," in *2018 International SoC Design Conference (ISOCC)*, Nov. 2018, pp. 257–258. doi: 10.1109/ISOCC.2018.8649905.
- [22] H. Lee, W. Lee, T. Kim, M. Helaoui, F. M. Ghannouchi, and Y. Yang, "6–18 GHz GaAs pHEMT broadband power amplifier based on dual-frequency selective impedance matching technique," *IEEE Access*, vol. 7, pp. 66275–66280, 2019, doi: 10.1109/ACCESS.2019.2917699.
- [23] M. Kim, K. Choi, and J. Kim, "W-band backward distributed frequency doubler using GaAs 0.15-0.15- $\mu$ m pHEMT process," *IEEE Microwave and Wireless Components Letters*, vol. 29, no. 6, pp. 400–402, Jun. 2019, doi: 10.1109/LMWC.2019.2913307.
- [24] A. Es-Saqy *et al.*, "5G mm-wave band pHEMT VCO with ultralow PN," *Advances in Science, Technology and Engineering Systems Journal*, vol. 5, no. 3, pp. 487–492, 2020, doi: 10.25046/aj050360.
- [25] A. Es-saqy *et al.*, "28 GHz balanced pHEMT VCO with low phase noise and high output power performance for 5G mm-Wave systems," *International Journal of Electrical and Computer Engineering (IJECE)*, vol. 10, no. 5, pp. 4623–4630, Oct. 2020, doi: 10.11591/ijece.v10i5.pp4623-4630.
- [26] S. C. Bera, "Microwave field effect transistors," in *Microwave Active Devices and Circuits for Communication*, 2019, pp. 79–110. doi: 10.1007/978-981-13-3004-9\_6.
- [27] J.-Y. Kim and W.-Y. Choi, "30 GHz CMOS self-oscillating mixer for self-heterodyne receiver application," *IEEE Microwave and Wireless Components Letters*, vol. 20, no. 6, pp. 334–336, Jun. 2010, doi: 10.1109/LMWC.2010.2047521.
- [28] M. Adhikary, A. Biswas, and M. J. Akhtar, "IF frequency tunable self oscillating mixer using cylindrical dielectric resonator VCO," in *2017 IEEE Applied Electromagnetics Conference (AEMC)*, Dec. 2017, pp. 1–2. doi: 10.1109/AEMC.2017.8325698.



## BIOGRAPHIES OF AUTHORS





**Abdelhafid Es-saqy**    was born in TISSA, Morocco, in January 1992. Received his master's degree in Microelectronics from Faculty of Sciences Dhar EL Mahraz Fez Morocco, in 2018. He is now Ph.D. student in Artificial Intelligence, Data Sciences and Emerging Systems Laboratory at the University of Sidi Mohamed Ben Abdellah Fez. He can be contacted at email: abdelhafid.essaqy@usmba.ac.ma.







**Maryam Abata**    born in 1989 in Nador, Morocco, obtained master's degree in 2012 at the National School of Applied Sciences. She received the Ph.D. in Telecommunications and Micro-waves Devices from Sidi Mohamed Ben Abdellah University of Fez. She can be contacted at email: maryam.abata@usmba.ac.ma.





**Mohammed Fattah**    received his Ph.D. in Telecommunications and CEM at the University of Sidi Mohamed Ben Abdellah (USMBA) Fez, Morocco, 2011. He is a professor in the Electrical Engineering Department of the High School of Technology at the Moulay Ismail University (UMI), Meknes, Morocco and he is a responsible of the research team 'Intelligent Systems, Networks and Telecommunications', IMAGE laboratory, UMI. He can be contacted at email: m.fattah@umi.ac.ma.





**Said Mazer**    born in 1978. He received the Ph.D. degree in electronics and signal processing from the University of Marne-La-Vallée, Champs-surMarne, France. He is currently a full Professor with the National School of Applied Sciences of Fez, Morocco. He is membre of IASSE Laboratory, University of Sidi Mohamed Ben Abdellah Fez. His research interests include the development of microwave-photonics devices for radio-over fibre and wireless applications, and he is also involved in network security. He can be contacted at email: said.mazer@usmba.ac.ma.





**Mahmoud Mehdi**    was born in Beirut, Lebanon, in 1974. He received his Ph.D. in high frequency communication systems from the university of Paris Marne la Vallée, France 2005. He is an associate professor in the Physics Department of the Faculty of sciences at the Lebanese University, Beirut, Lebanon. His research interests include monolithic microwave integrated circuits, micro-electro-mechanical systems (MEMS), radiofrequency, double balanced and distributed mixers, local oscillator, TW amplifiers, optoelectronic mixer for LIDAR system, optical systems and design, and photo-detectors. He is course leader in microwave devices for the Masters program in Electronics. He can be contacted at email: mahmoud.mehdi@ul.edu.lb.f.



**Moulhime El Bekkali**    holder of a doctorate in 1991 from the USTL University-Lille 1-France, he worked on antennas printed in X-band and their applications to microwave radar. Since 1992, he was a professor at the Graduate School of Technology, Fez (ESTF) and he was a member of the Transmission and Data Processing Laboratory (LTTI). In 1999, he received a second doctorate in electromagnetic compatibility from Sidi Mohamed Ben Abdellah University (USMBA). Since 2009, Pr. El Bekkali has been Vice-President of Research and Cooperation at the Sidi Mohamed Ben Abdellah University (USMBA) in Fez-Morocco until 2018. Currently, he is a professor at the National School of Applied Sciences (ENSAF) and member of the LIASSE laboratory at Sidi Mohamed Ben Abdellah University. He can be contacted at email: moulhime.elbekkali@usmba.ac.ma.



**Catherine Algani**    born in 1963. Ph.D. in electronics at the University Pierre and Marie Curie (Paris VI). University professor at the National Conservatory of Arts and Crafts, CNAM-Paris. She is the responsible of the research team "communication systems" at ESYCOM laboratory. She can be contacted at email: catherine.algani@lecnam.net.