



HAL
open science

Baseline-free algorithms for damage localization in composite structures

Cedric Bertolt Nzouatchoua, Mourad Bentahar, Silvio Montrésor, Nicolas Colin, Vincent Le Cam

► **To cite this version:**

Cedric Bertolt Nzouatchoua, Mourad Bentahar, Silvio Montrésor, Nicolas Colin, Vincent Le Cam. Baseline-free algorithms for damage localization in composite structures. NDT.net. Les Journées COFREND, Jun 2023, Marseille, France. . hal-04484083

HAL Id: hal-04484083

<https://hal.science/hal-04484083>

Submitted on 29 Feb 2024

HAL is a multi-disciplinary open access archive for the deposit and dissemination of scientific research documents, whether they are published or not. The documents may come from teaching and research institutions in France or abroad, or from public or private research centers.

L'archive ouverte pluridisciplinaire **HAL**, est destinée au dépôt et à la diffusion de documents scientifiques de niveau recherche, publiés ou non, émanant des établissements d'enseignement et de recherche français ou étrangers, des laboratoires publics ou privés.

Baseline-free algorithms for damage localization in composite structures

Cédric Bertolt Nzuouatchoua ^{1,2,3}, Mourad Bentahar ¹, Silvio Montessoro ¹, Nicolas Colin ², Vincent Le Cam ³

1. Laboratoire d'Acoustique de l'Université du Mans (LAUM), UMR CNRS 6613, Institut d'Acoustique - Graduate School (IA - GS), CNRS, Le Mans Université, 72085 Le Mans, France

2. IRT Jules Verne, NANTES Université, F-44000 Nantes, France

3. Laboratoire Structure et Instrumentation Intégrée (SII), Inference for Structures (I4S) team, département Composants et Systèmes (COSYS), Université Gustave Eiffel, 44344 Bouguenais Cedex, France

Abstract

Guided waves based structural health monitoring, mainly Lamb waves, have a great potential for localization of wavelength-order damage within plate-like composite structures. Baseline algorithms are often criticized for not taking into account environmental conditions such as temperature and damage prior to the creation of baseline signals. The current trend is to develop new algorithms using only measurements in the current state.

This thesis work aims to implement and apply new baseline-free algorithms coupled with the optimization of the placement and the number of sensors, in order to achieve a good diagnosis of complex composite structures.

Keywords : SHM, Lamb waves, impact damage, composite structures, Baseline-free algorithms

SHM

- Evaluation of structures's integrity over time, in order to maintain and extend their lifespan, to detect and predict their failures.
- SHM system with Rytter's scale ^[1]

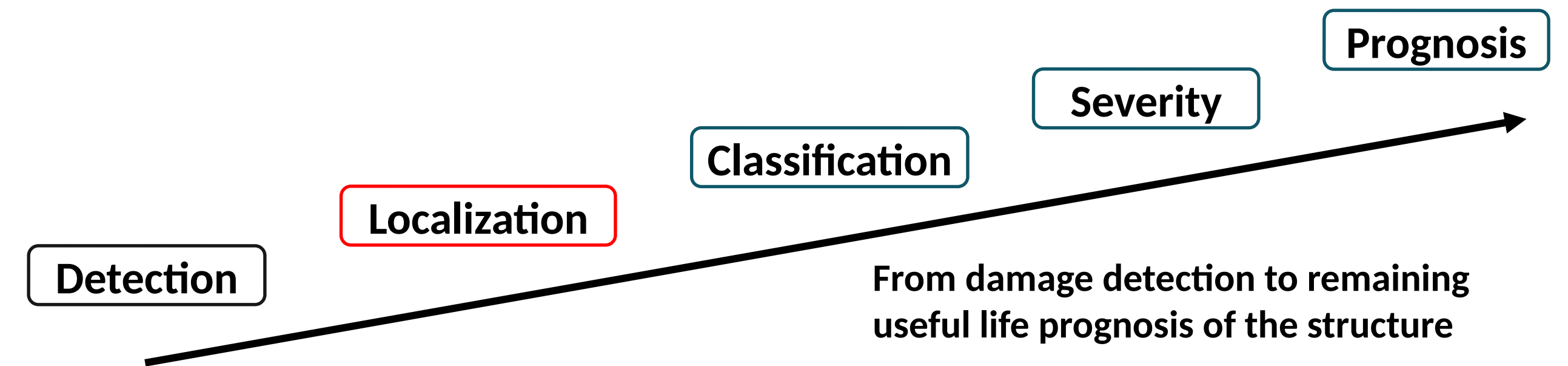

Guided Lamb waves based SHM for monitoring of composite structures

Experimental description

- Characterization of the propagation properties of composite structures by laser measurements while one of the PZT transmits the excitation signal.



Stiffened composite panel with a curvature

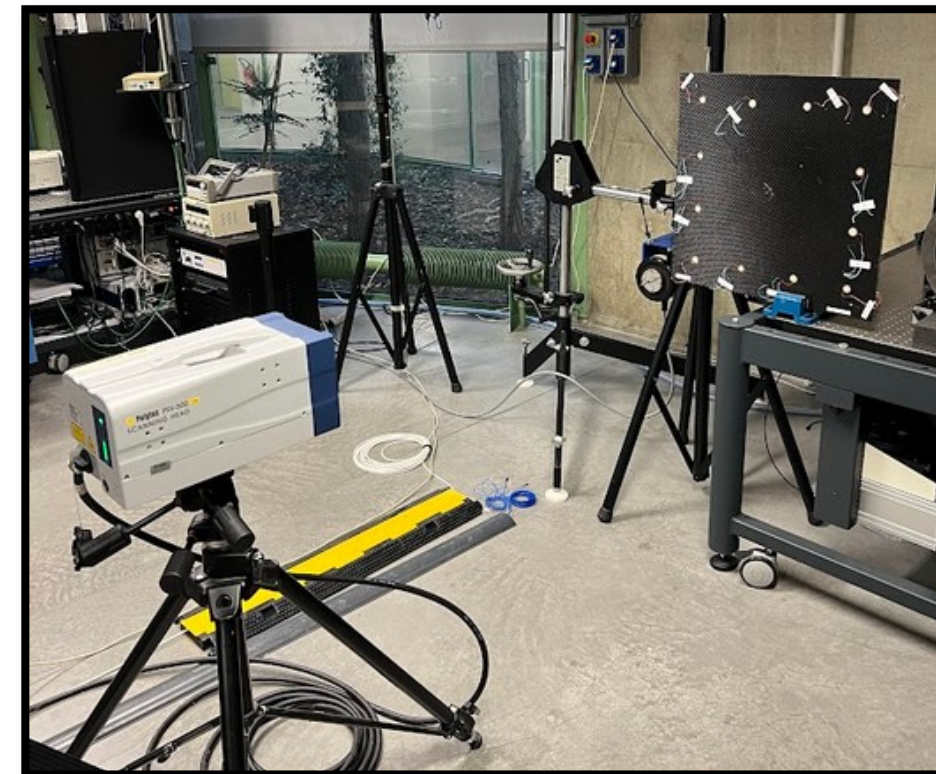

Composite plate with an orthotropic symmetry

- Acquisitions at the damaged state with the help of a system whose communication with the data processing computer is wireless.

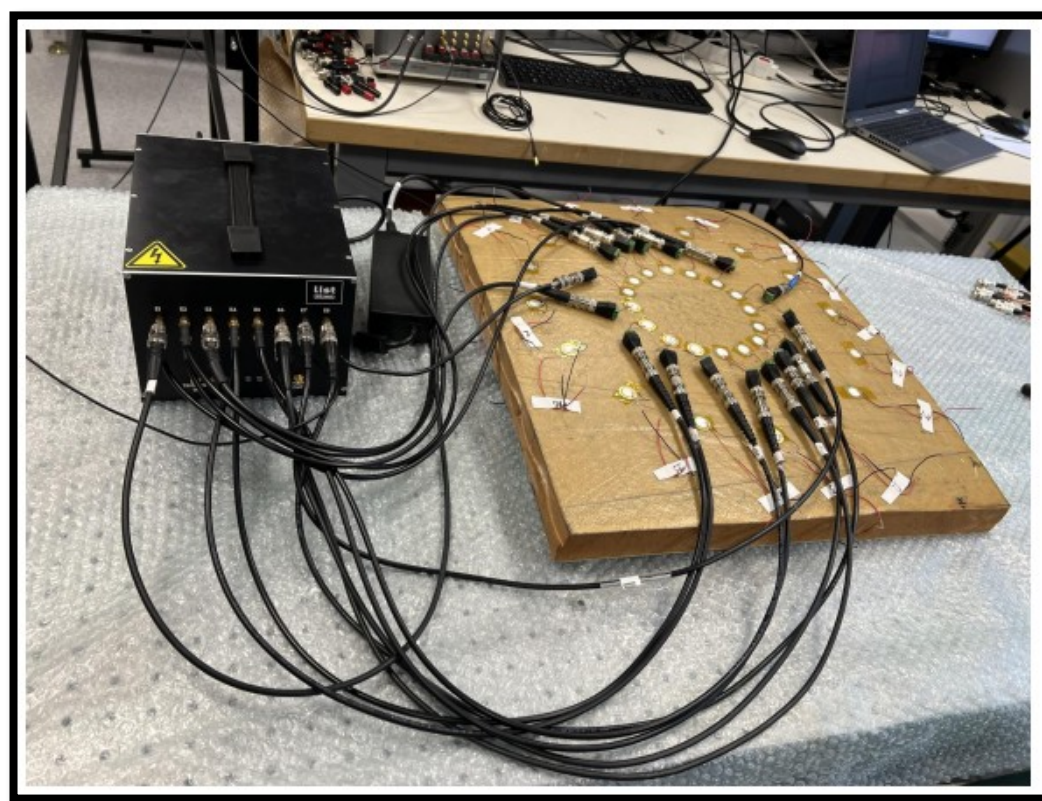

Damaged curved wind turbine blade sample

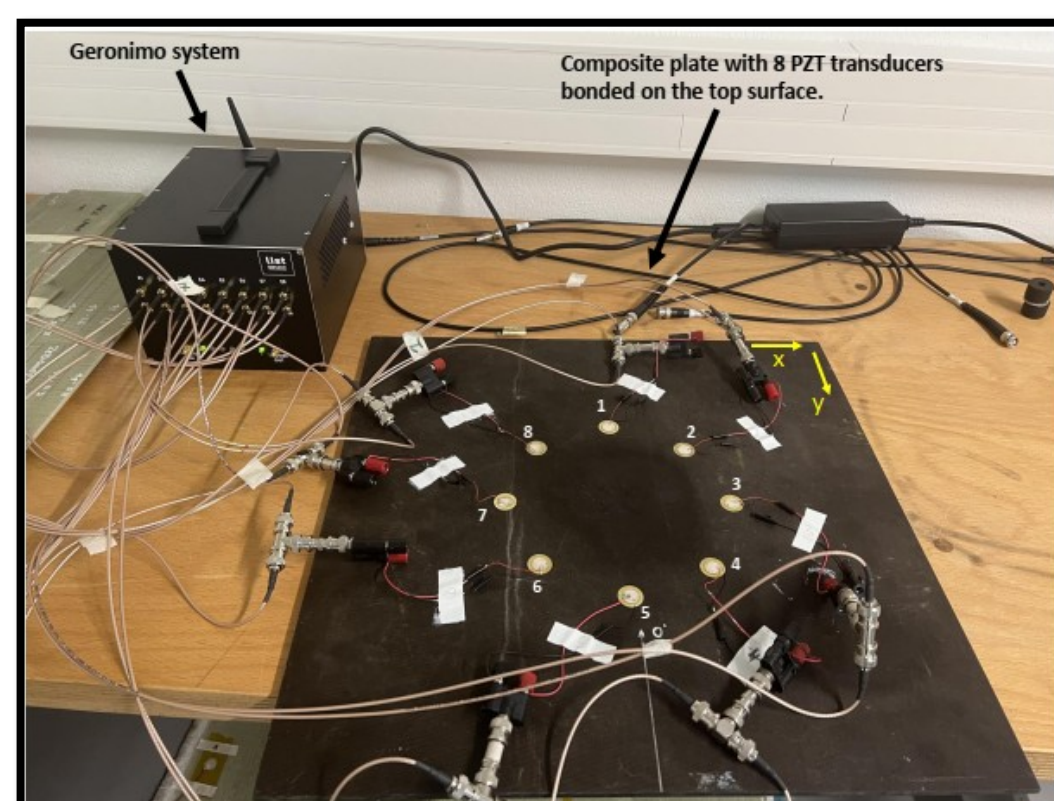

Transverse isotropic composite plate

Restrictions of baseline algorithms

- Large range of variation of the operational and environmental conditions (EOC).
- Addition of sensors for the measurement of EOC which can weigh down the structure.
- Damage prior to the creation of the baseline cannot be taken into account.

Objectives

- Implementation and application of new relevant algorithms based on Lamb waves for 2D imaging of damages on composite structures.
- Implementation and application of new PZT sensors placement and number optimization algorithms in a network.

Lamb waves

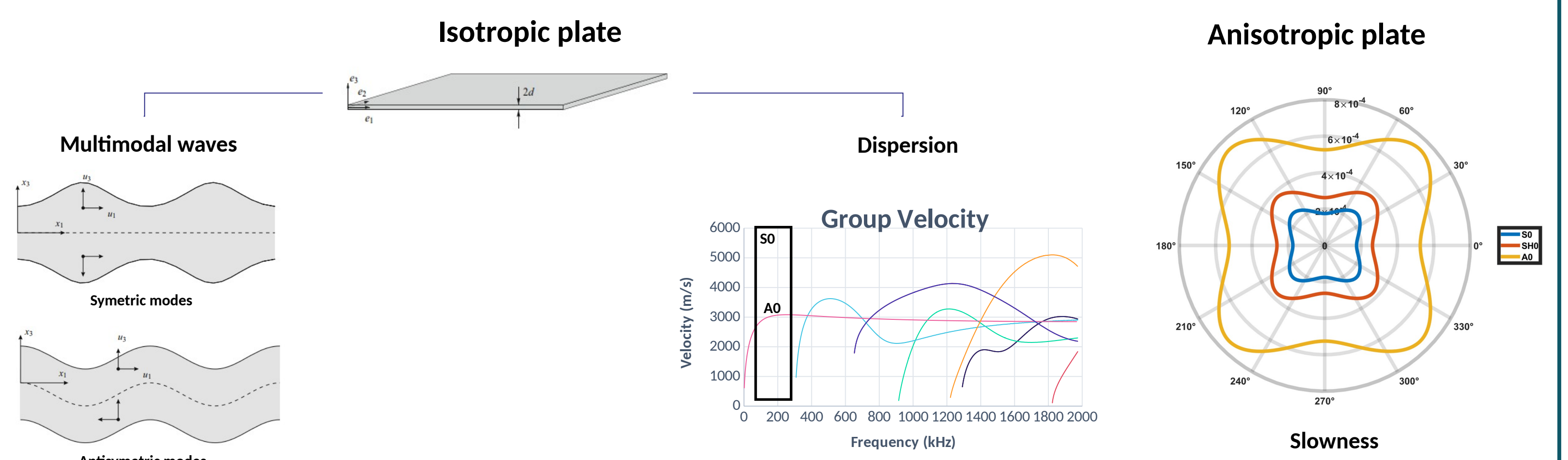

- Propagation, interaction with damages and localisation algorithms

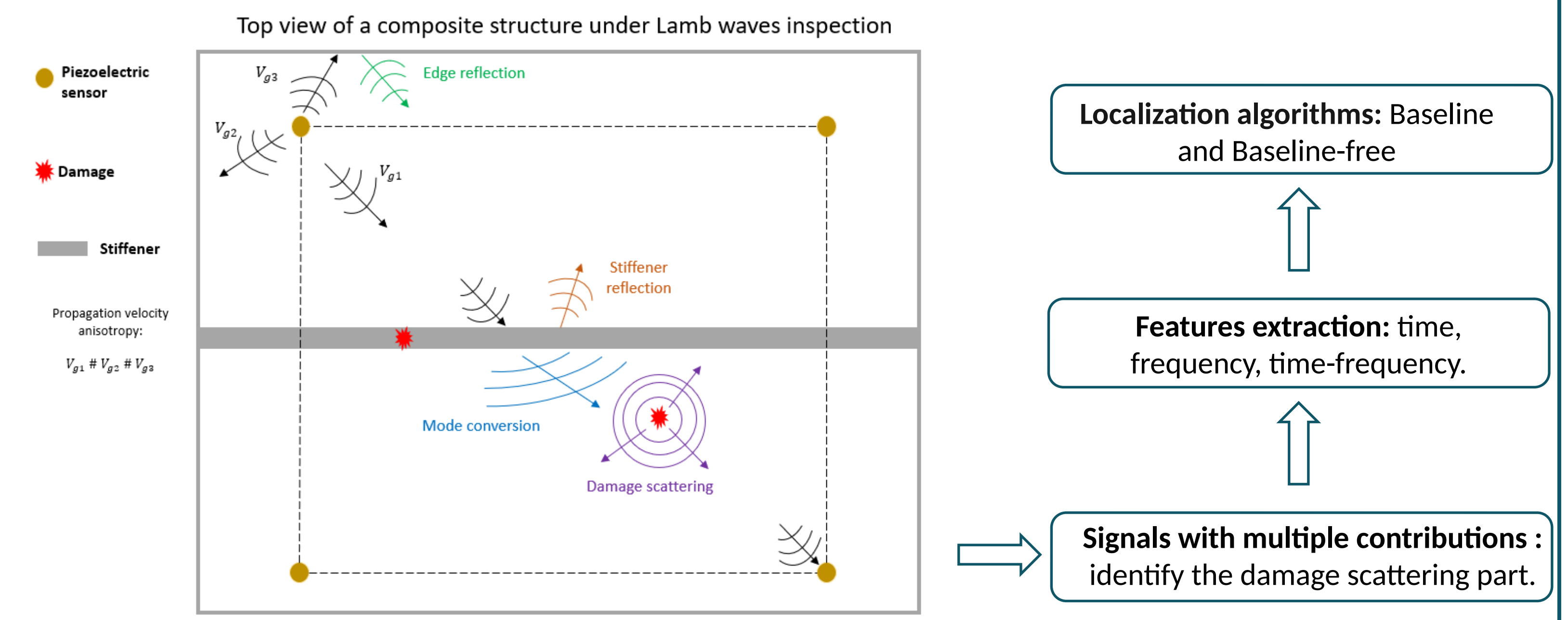

New Damage Localization Methods ^[4]

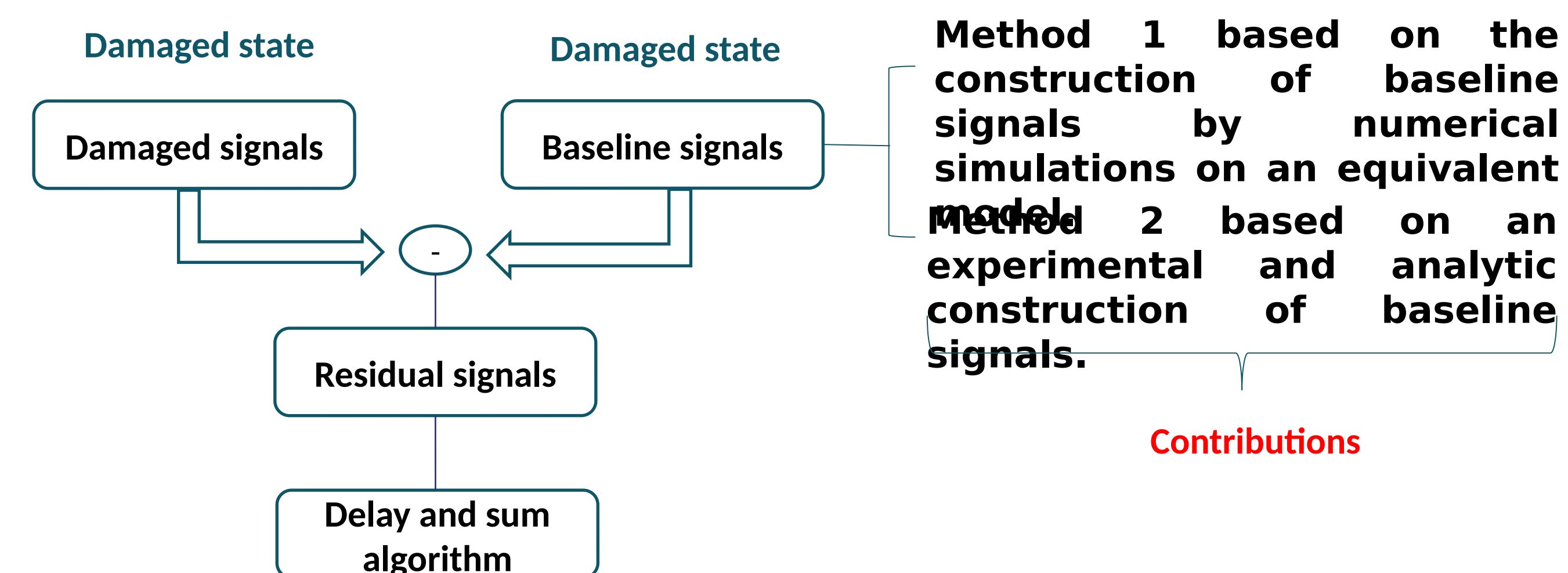

Results

- Impact damage localization results on the transverse isotropic composite plate

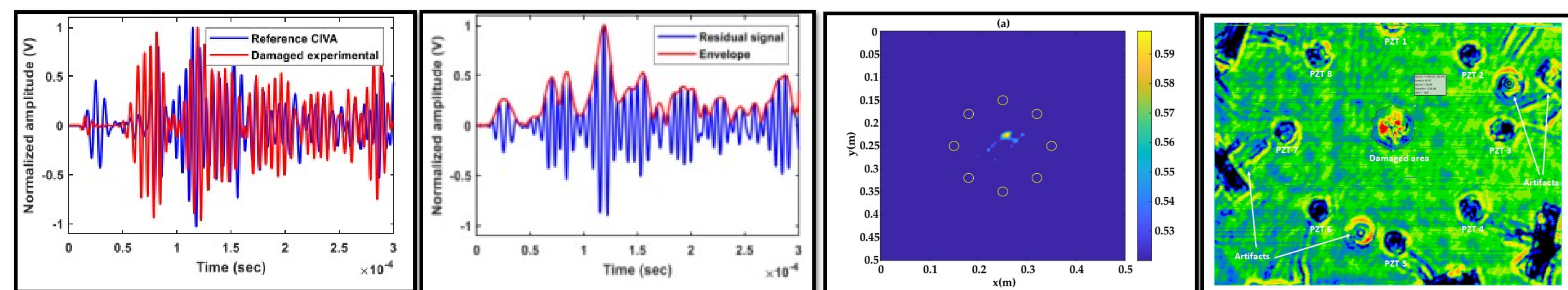

- Impact damage localization results on the curved wind turbine blade sample with delay-and-sum using actual baseline signals and with method 2 using reconstructed baseline signals

Ongoing work

- Application of new damage localisation methods on large complex composites structures.



Stiffened composite panel



IPN beam

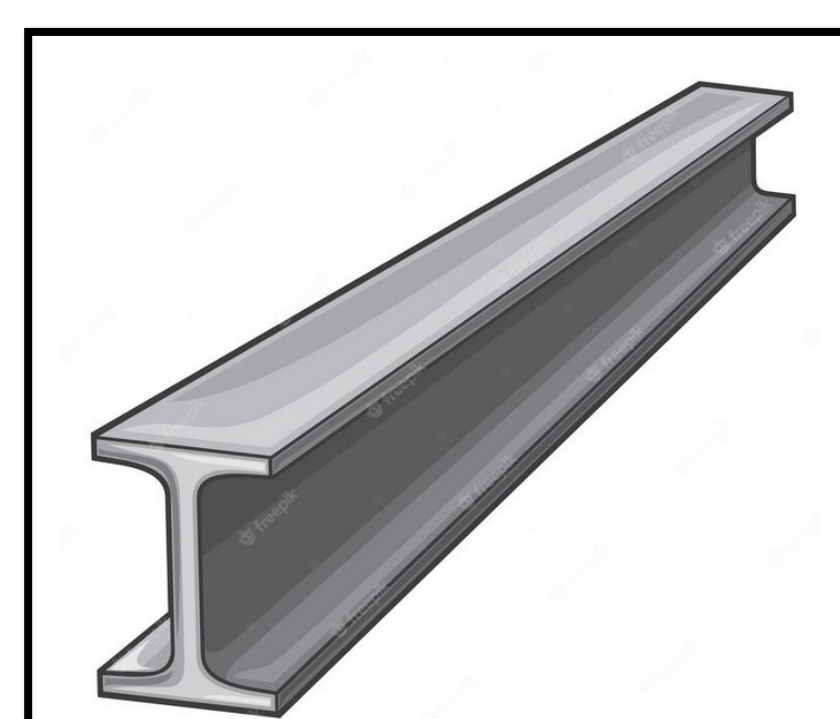

Piece of rail

- New algorithm for optimal placement of sensors while minimizing the number of sensors.

- Application of Wireless Sensors Network (WSN) with at least two electronic nodes.

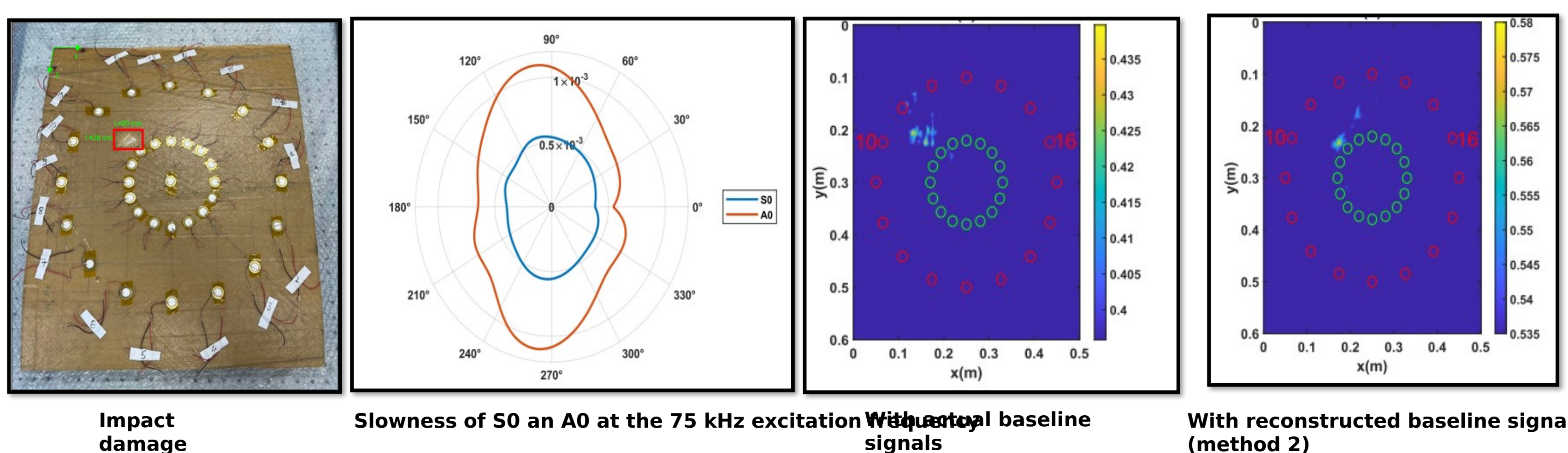

Bibliography

- [1] Rytter, A. (1993), *Vibrational Based Inspection of Civil Engineering Structures*, PhD thesis. Ph.D.-Thesis defended publicly at the University of Aalborg, April 20, 1993 PDF
- [2] Torkamani, A., Roy, Mark E Barkey, Edward Sazonov, Susan Burkett, et Sushma Kotru. « A Novel Damage Index for Damage Identification Using Guided Waves with Application in Laminated Composites ». *Smart Materials and Structures* 23, n° 095015 (7 août 2014).
- [3] Lize, Emmanuel. « Détection d'endommagement sans état de référence et estimation de la température pour le contrôle santé intégré de structures composites par ondes guidées ». *Ecole nationale supérieure d'arts et métiers - ENSAM*, 2018.
- [4] Nzuouatchoua, Cedric Bertolt, Mourad Bentahar, Silvio Montessoro, Nicolas Colin, Vincent Le Cam, Camille Trottier, et Nicolas Terrien. « Damage Localization on Composite Structures Based on the Delay-and-Sum Algorithm Using Simulation and Experimental Methods ». *sensors* 23, n° 4368 (28 avril 2023).