



**HAL**  
open science

## Compression behaviour of Al3003 alloy at varying temperatures and strain rates

Daniel Bedoya Vallejo, Eric Fleury, Jérôme Serri, Thierry Mazet, Gaëtan Bergin

► **To cite this version:**

Daniel Bedoya Vallejo, Eric Fleury, Jérôme Serri, Thierry Mazet, Gaëtan Bergin. Compression behaviour of Al3003 alloy at varying temperatures and strain rates. International Conference on Strength of Materials, ICSMA19, Jun 2022, Metz, France. hal-04479168

**HAL Id: hal-04479168**

**<https://hal.science/hal-04479168>**

Submitted on 27 Feb 2024

**HAL** is a multi-disciplinary open access archive for the deposit and dissemination of scientific research documents, whether they are published or not. The documents may come from teaching and research institutions in France or abroad, or from public or private research centers.

L'archive ouverte pluridisciplinaire **HAL**, est destinée au dépôt et à la diffusion de documents scientifiques de niveau recherche, publiés ou non, émanant des établissements d'enseignement et de recherche français ou étrangers, des laboratoires publics ou privés.

# Compression behaviour of Al3003 alloy at varying temperatures and strain rates

Daniel BEDOYA<sup>1,2</sup>, Eric FLEURY<sup>1</sup>, Jérôme SERRI<sup>1</sup>, Thierry MAZET<sup>2</sup> et Gaëtan BERGIN<sup>2</sup>

1. Laboratoire d'Etude des Microstructures et de Mécanique des Matériaux (LEM3), UMR 7239, CNRS / Université de Lorraine, 57070, Metz, France  
2. Fives Cryo, 25 bis rue du Fort, 88190 Golbey, France

## Introduction

Al3003 is a widely used for general-purpose aluminium alloy. Assemblies involving these alloys are often subjected to thermomechanical loadings with varying strain rates. The optimisation of assemblies in their production phases and/or utilisation can be achieved through the use of numerical simulation such as finite element techniques. Finite element (FE) simulation of the response of these assemblies requires the obtention of the material behaviour through a suitable constitutive model. For that purpose, a series of compressive tests have been performed for temperatures within the ambient temperature till 550°C and strain rates ranging from  $5 \times 10^{-5}$  to  $5 \times 10^{-2} \text{ s}^{-1}$ .

## Protocol and Experimental Device

### Samples

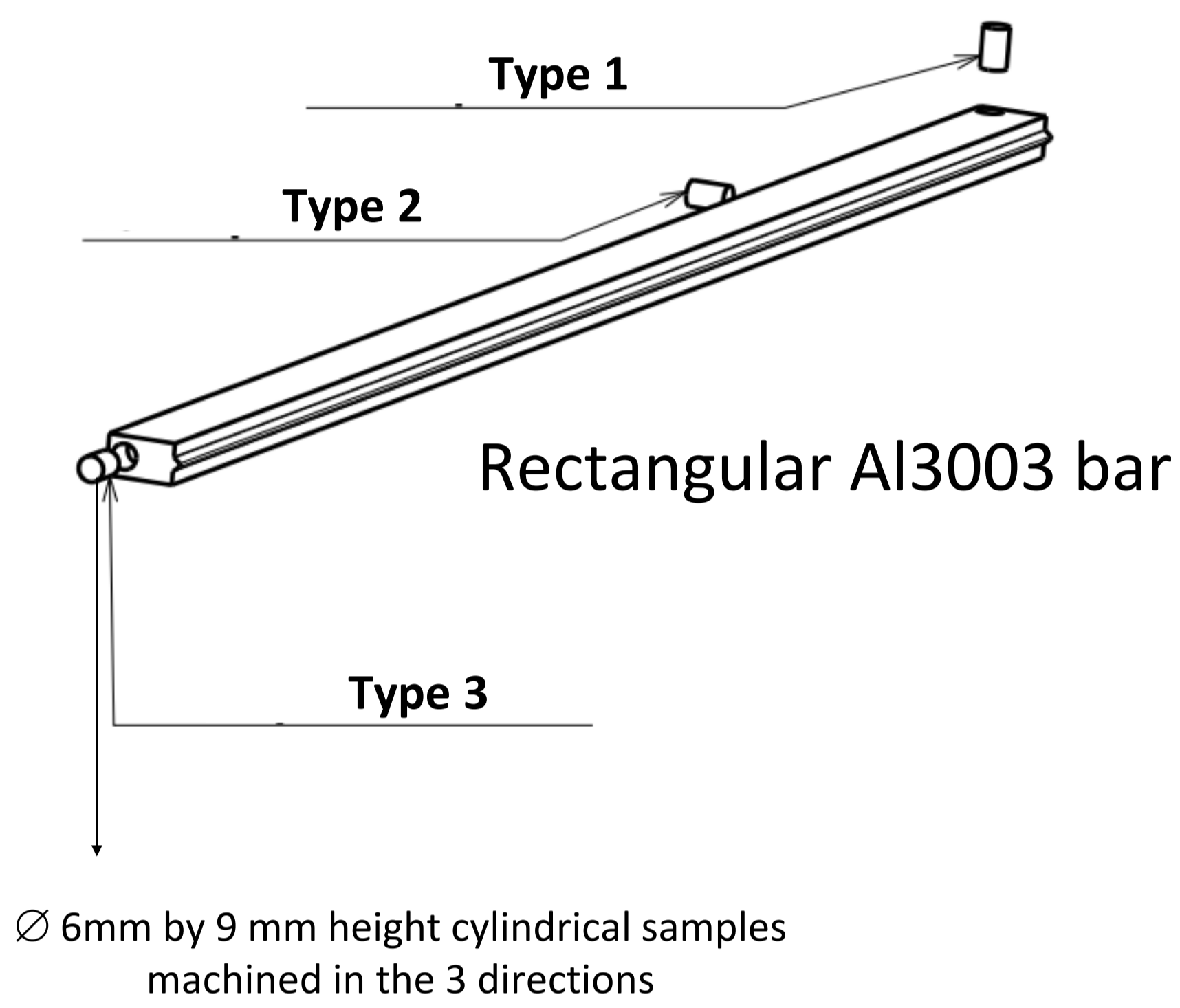

### Equipment for high temperature tests

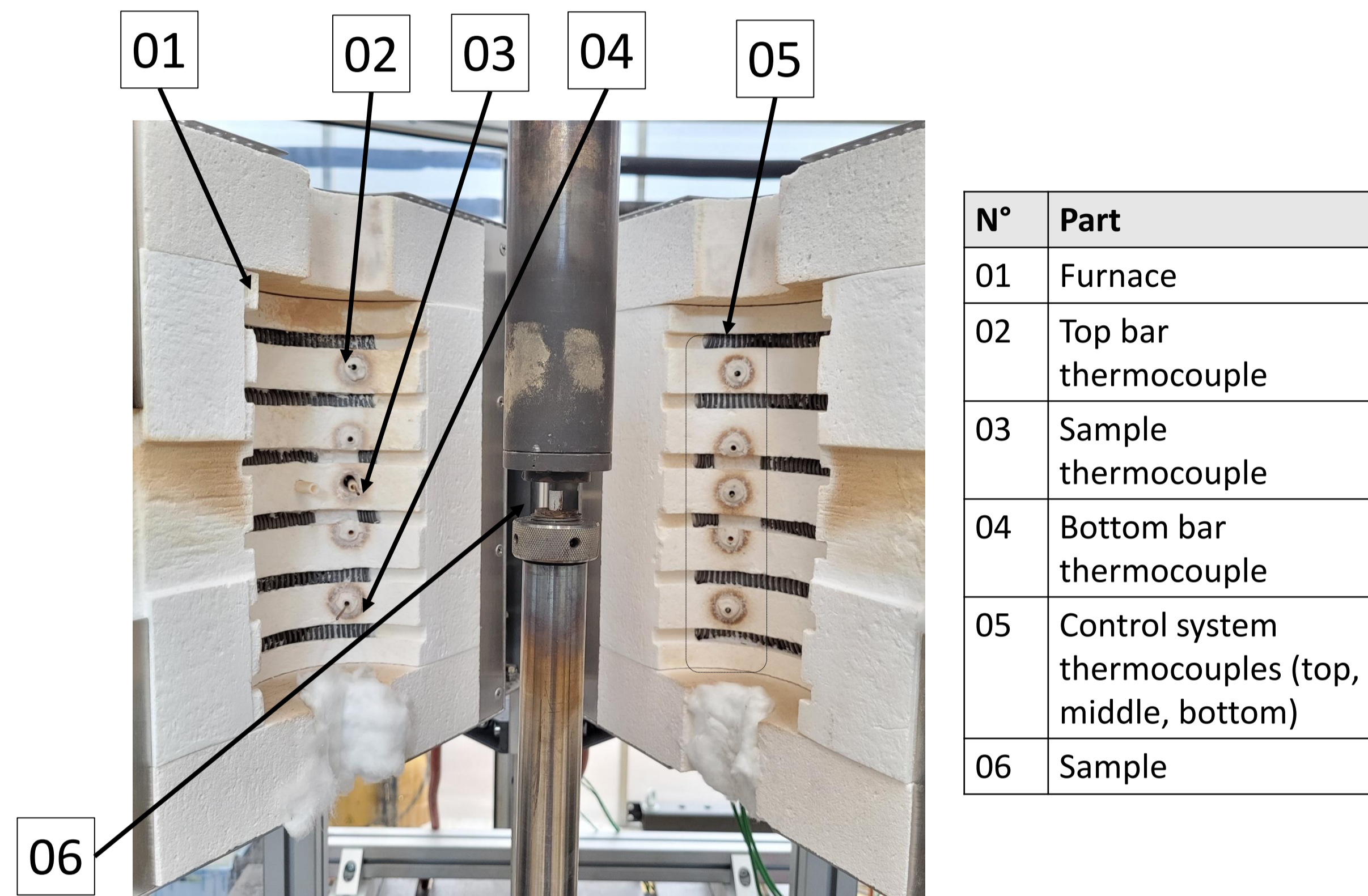

### Slavik-Sehitoglu elasto-viscoplastic model [1]

Flow rule

$$\dot{\epsilon}^{in} = \begin{cases} A \cdot \left(\frac{\sigma - \alpha}{K}\right)^7 & \text{if } \left(\frac{\sigma - \alpha}{K}\right) \leq 1 \\ A \cdot \exp\left[\left(\frac{\sigma - \alpha}{K}\right)^7 - 1\right] & \text{if } \left(\frac{\sigma - \alpha}{K}\right) > 1 \end{cases}$$

#### Back stress rate

$$\dot{\alpha} = h_{\alpha} \dot{\epsilon}^{in} - r_{\alpha} \times \alpha$$

with  $h_{\alpha}$  : back stress hardening and  $r_{\alpha}$  : back stress recovery

#### Drag stress rate

$$\dot{K} = h_K - r_K + \Phi \dot{T}$$

with  $h_K$  : drag stress hardening and  $r_K$  : drag stress recovery

## Results : Evolution of compressive behaviour with strain rate and temperature

True stress - plastic strain of Al3003 at a strain rate  $\dot{\epsilon} = 5 \times 10^{-3} \text{ s}^{-1}$  Type 3

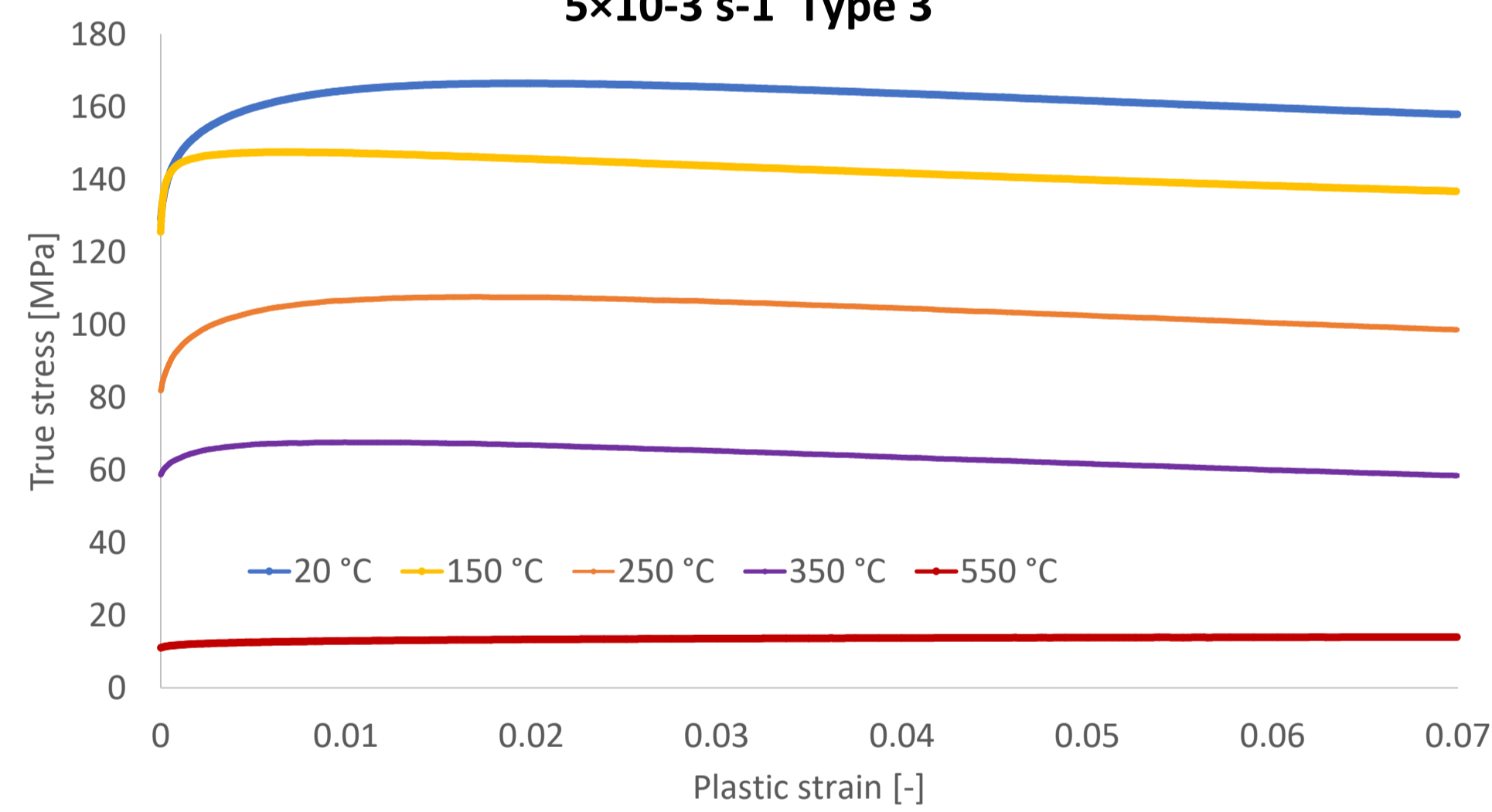

Al3003 displayed a softening behavior between room temperature and 350 °C

Variation of the yield stress with strain rate and temperature type-3

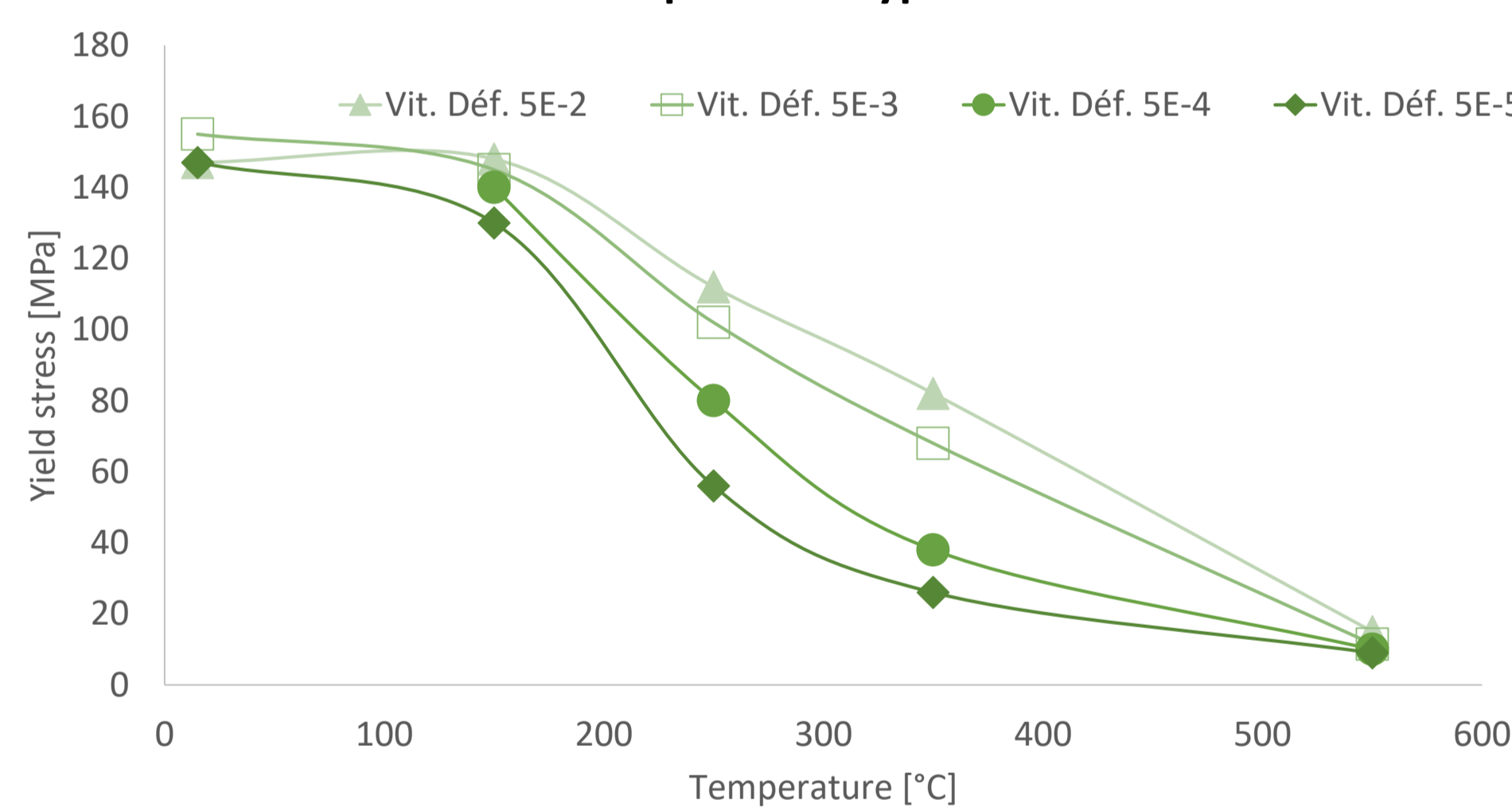

Pronounced decrease of the yield stress beyond  $T=150^{\circ}\text{C}$  and a marked effect of strain rate

Strain rate sensitivity parameter, m

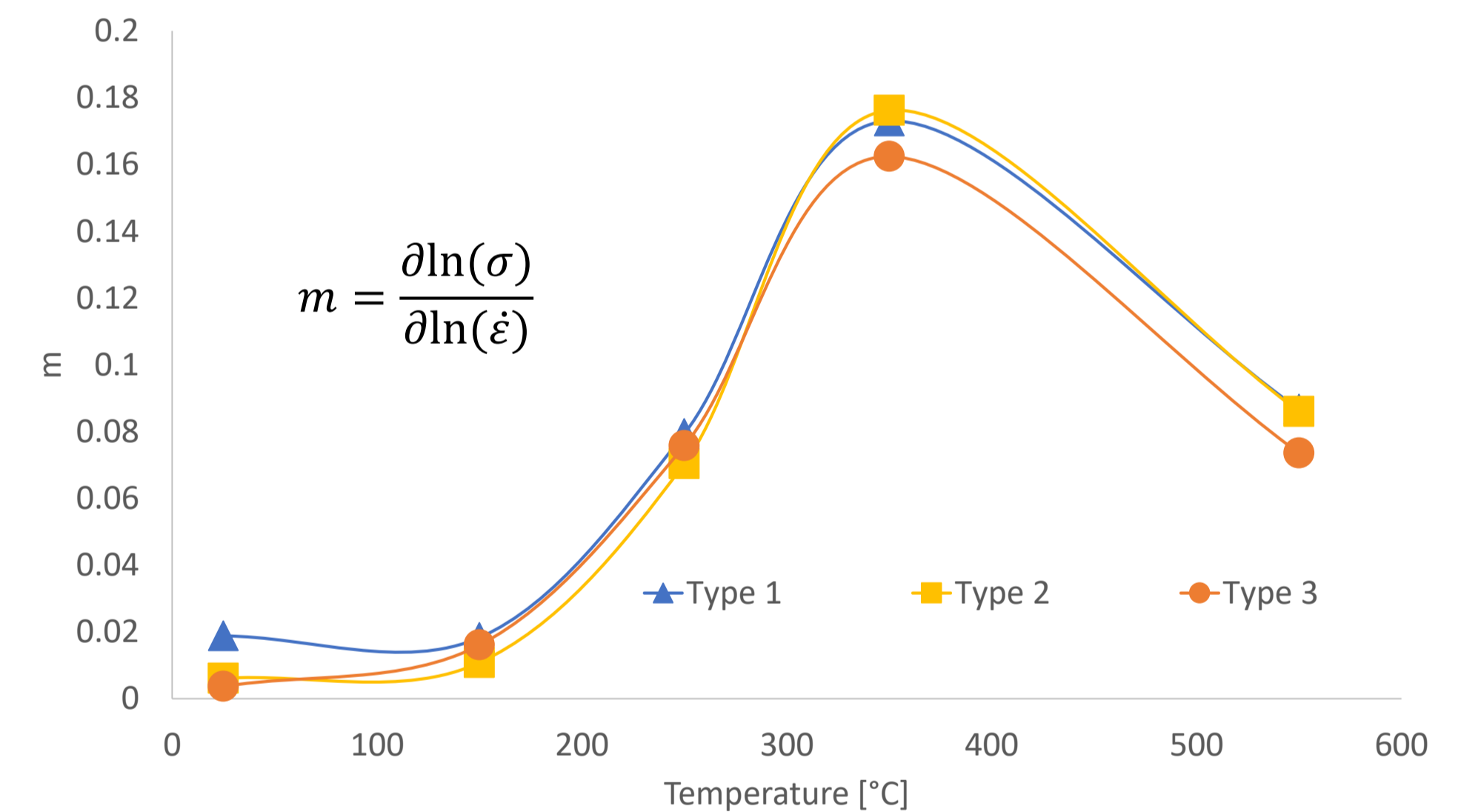

The maximum value of the strain rate sensitivity parameter was found around 350 °C

Tests at 250 °C - strain rate  $5 \cdot 10^{-3} \text{ s}^{-1}$

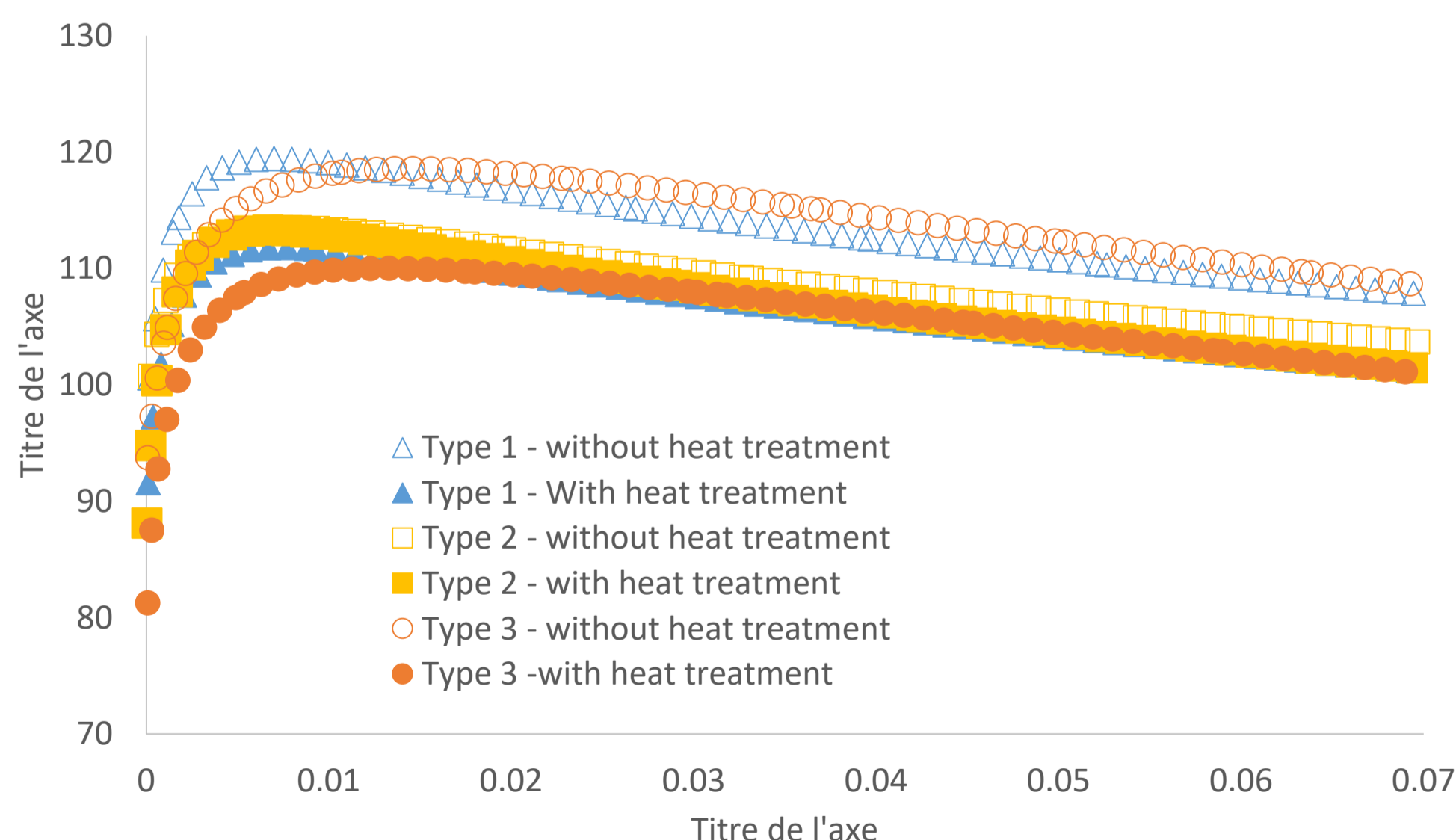

Minor dependence with the loading direction, particularly after annealing treatment

Stress relaxation test -  $T=250^{\circ}\text{C}$

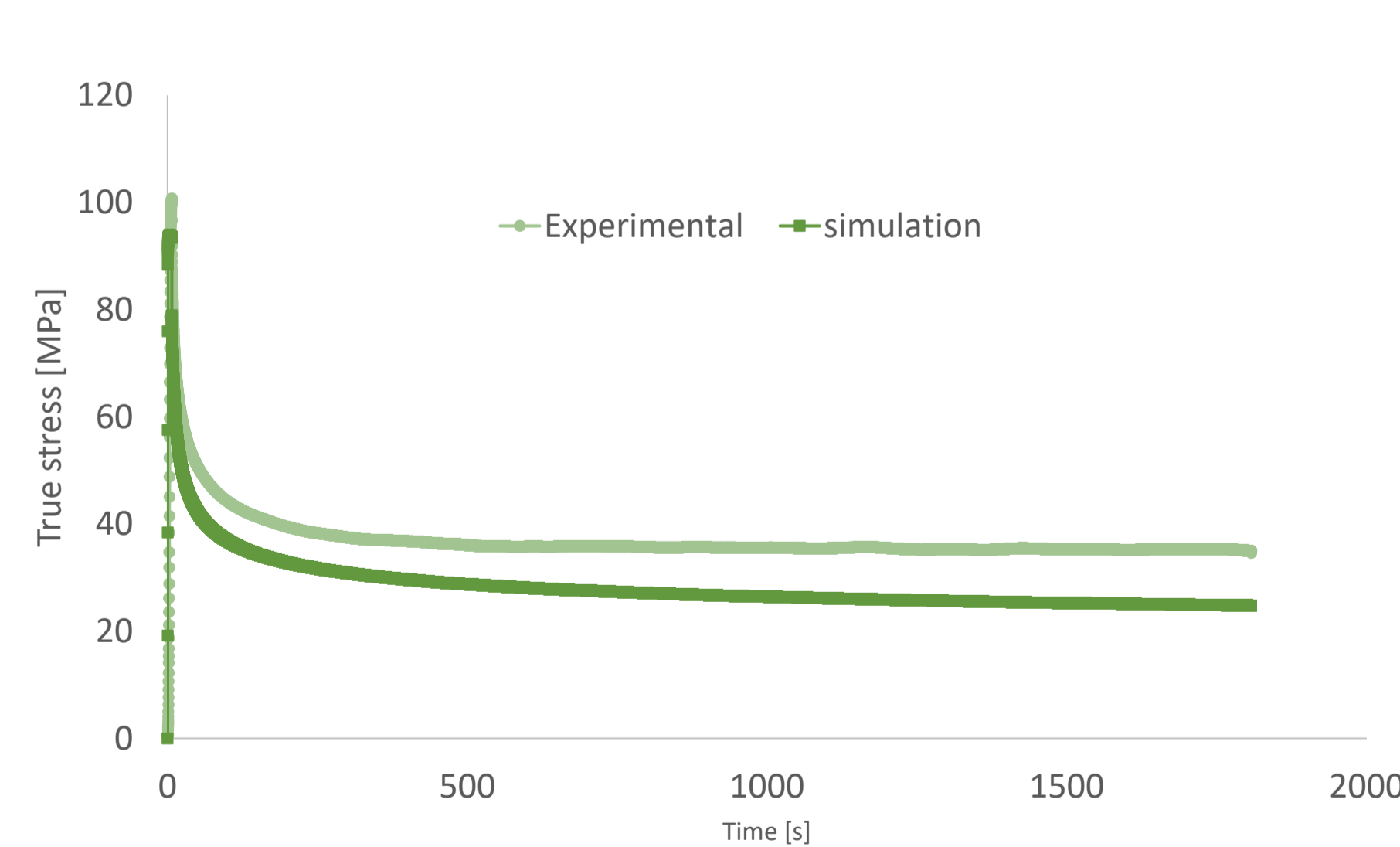

Important stress relaxation observed at  $T=250^{\circ}\text{C}$  which can be well described by the Slavik-Sehitoglu model

Measured true stress - plastic strain of Al3003 at a strain rate  $\dot{\epsilon} = 5 \times 10^{-3} \text{ s}^{-1}$  Type 3

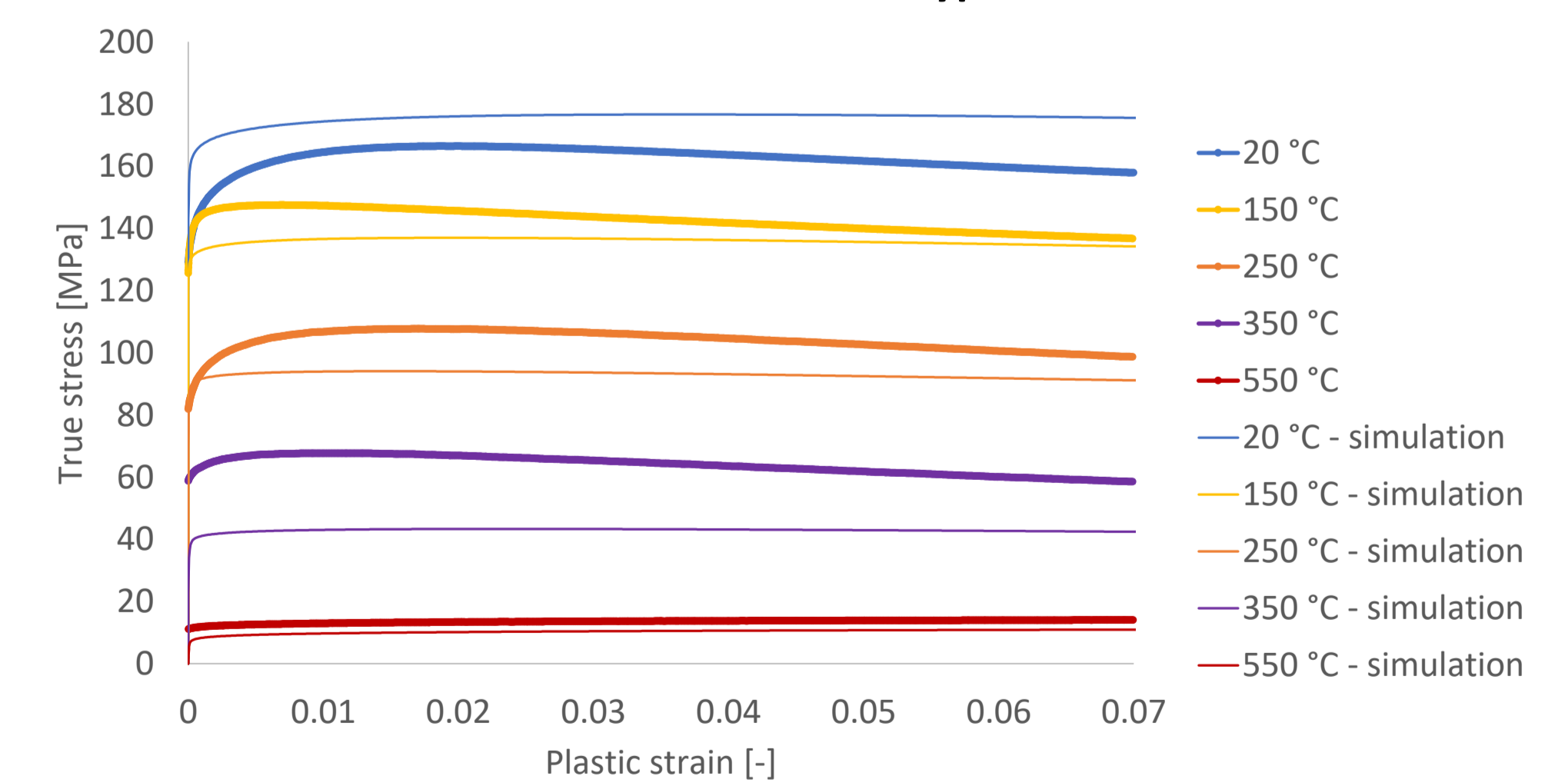

The Slavik-Sehitoglu model reproduces relatively well the temperature and strain rate dependency of the mechanical behavior

## Conclusion

- The mechanical behaviour of Al3003 displayed a light softening mechanism without pronounced dependency of the anisotropy
- Viscous behaviour of the material was exhibited at 250 °C
- This behaviour has been approximated by means of the Slavik-Sehitoglu elasto-viscoplastic model.
- Optimization of the model parameters and comparison with other elasto-viscoplastic models is currently in progress.
- This constitutive model will be implemented in a finite element simulation.