

Ultra low power Cochlea for biodiversity monitoring

François Danneville¹

Hicham Leach¹, Pierre Boulet², Philippe Devienne², Hervé Glotin³, Christophe Loyez¹

Colloque Biocomp 2023, Banyuls sur Mer

1. *IRCICA, UAR CNRS 3380 et IEMN, UMR CNRS 8520, Villeneuve d'Ascq*
2. *CRISTAL, UMR CNRS 9189, Villeneuve d'Ascq*
3. *LIS, UMR CNRS 7020, Toulon*

Biodiversity

Biodiversity Loss

Main scientific and
Societal challenge

Stimulate research in AI

Requirement of passive acoustic sensors:

- Detection, Classification, Localization
- Human / Nature acoustic Event
- 2 challenges:
 - Biodiversity Monitoring
 - Energetic frugality (carbon footprint as low as possible)

Tous droits réservés

Biodiversity / Data Deluge

□ Biodiversity :

- Between 1970 and 2018, 69% of wildlife* population declined :
 - Terrestrial environment and/or Marine ecosystems
 - **26%** Marine and/or Terrestrial mammals and **14%** birds are threatened (**)

□ Data deluge :

- Digital data (processing / communication) grows exponentially
- ICT technologies represent 4% of carbon footprint worldwide (projection is **14%** *** en 2040)

* Perrine Mouterde, *Le Monde*, 13 Octobre 2022

** https://www.ecologie.gouv.fr/biodiversite-presentation-et-informations-cles#scroll-nav_4

*** L. Belkhir et al, « Assessing global emission footprint : Trends to 2040 & recommendations », *Journal of Cleaner Production*, 2018

Tous droits réservés

Objective (i)

Development of a quasi-autonomous « embedded »
electronic system (maintenance every 3 years)

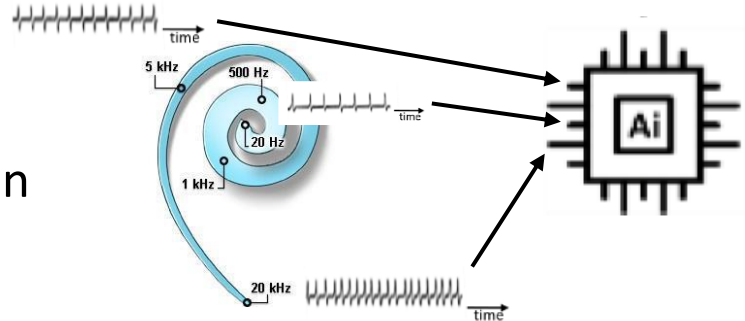

Artificial Cochlea :

- Analog information pre-processing
- Ultra frugal (power consumption)
- Mature CMOS Technology

Biodiversity Monitoring:

- Passive Bioacoustic Technology
(**non-invasive**, respect wildlife)

« local » information processing:

- Information Processing of « natural data » provided by the cochlea, **locally carried out** (« off the cloud »)

Objectives (ii)

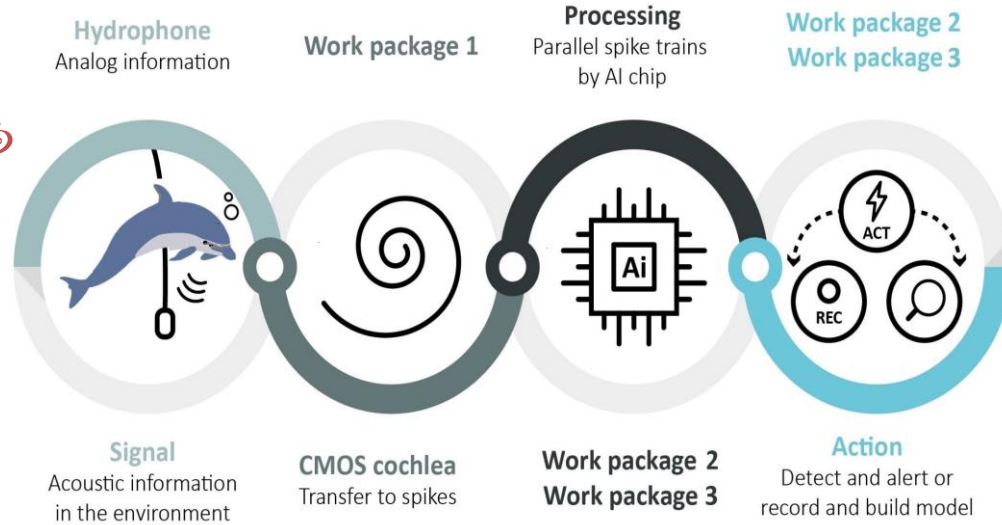

Tous droits réservés

❑ Sensor characteristics:

- Classification/counting of cetaceans (unsupervised learning)
- Compact design
- Carbon footprint as low as possible
- Low cost

Objectives (iii)



- ❑ Design of a monaural / binaural analog artificial Cochlea
 - *Ultra low power (< 30 μ Watt), 100 kHz Bandwidth*
 - *Coincidence Detector for sound localization*
- ❑ Design of AI chip to carry out biocomputing of « natural data » (generated by the Cochlea)
 - *Software Development based on Spiking Neural Networks trained for Ceteceans classification*
- ❑ Detection / Localization of specific acoustic events with main goal to preserve Ceteceans
 - *Add « alert » functionality to detect anthropogenic noise perturbing biodiversity*

Tous droits réservés

Objectives (iv)



- ❑ Design of a monaural / binaural analog artificial Cochlea
 - *Ultra low power (< 30 μ Watt), 100 kHz Bandwidth*
 - *Coincidence Detector for sound localization*
- ❑ Design of AI chip to carry out biocomputing of « natural data » (generated by the Cochlea)
 - *Software Development based on Spiking Neural Networks trained for Ceteceans classification*
- ❑ Detection / Localization of specific acoustic events with main goal to preserve Ceteceans
 - *Add « alert » functionality to detect anthropogenic noise perturbing biodiversity*

Tous droits réservés

G. V. Kékésy ~ 1960*

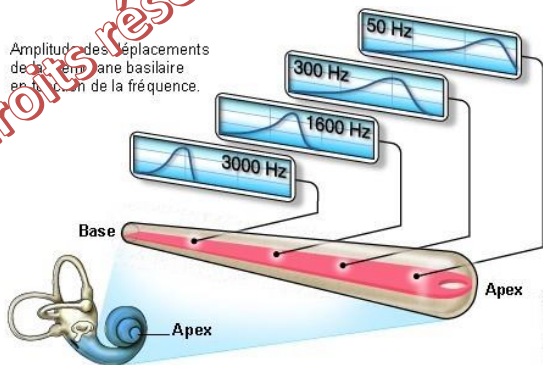

Passive
Tonotopy

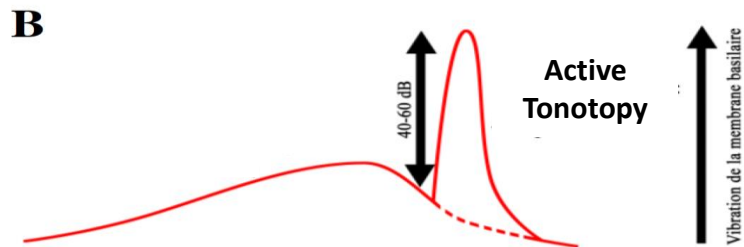
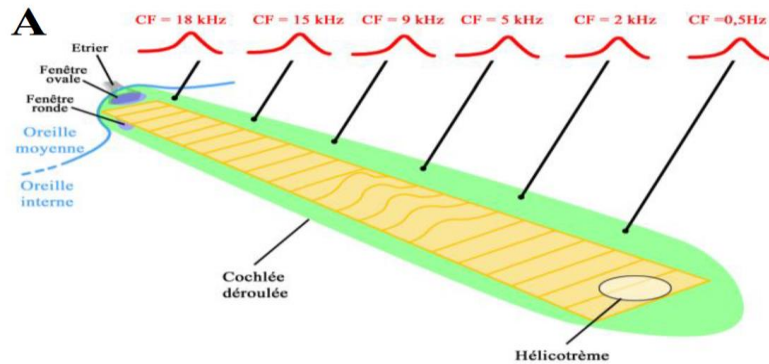

* <https://www.cochlea.eu/cochlee/fonctionnement>

Artificial Cochlea : the Pioneers (i)

IEEE TRANSACTIONS ON ACOUSTICS, SPEECH, AND SIGNAL PROCESSING, VOL. 36, NO. 7, JULY 1988

An Analog Electronic Cochlea

RICHARD F. LYON, MEMBER, IEEE, AND CARVER MEAD

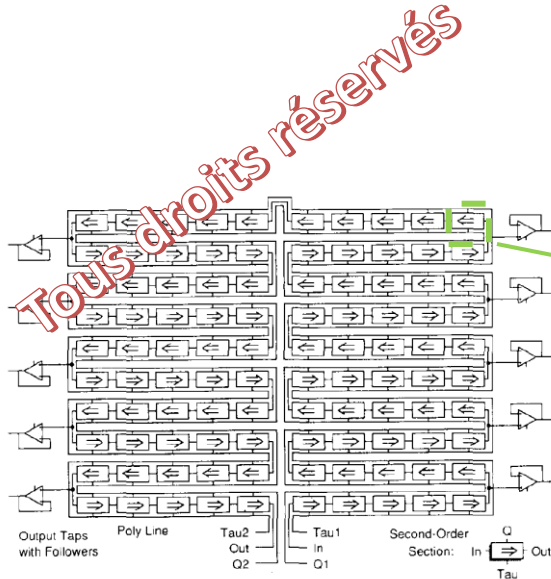

Tous droits réservés

Basic Unit :
2nd order Filter

$$H(s) = \frac{1}{\tau^2 s^2 + \frac{1}{Q} \tau s + 1}$$

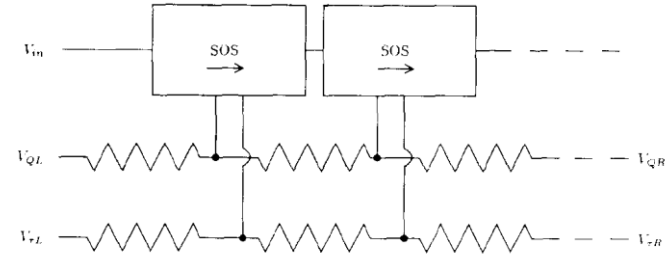

Fig. 3. Silicon cochlea, consisting of a serial cascade of second-order sections and tilted bias lines.

Fig. 8. Floorplan of 100-stage cochlea chip, in serpentine arrangement. The wires that are shown connecting the TAU and Q control terminals of the filter stages are built using a resistive polysilicon line, to act as a voltage divider that adjusts the bias currents in the cascade as an exponential function of distance from the input.

An Analog Electronic Cochlea

RICHARD F. LYON, MEMBER, IEEE, AND CARVER MEAD

Tous droits réservés

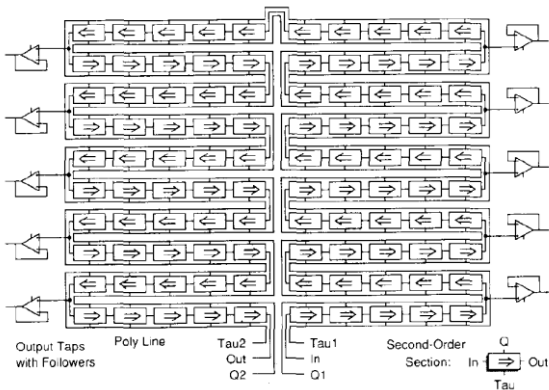
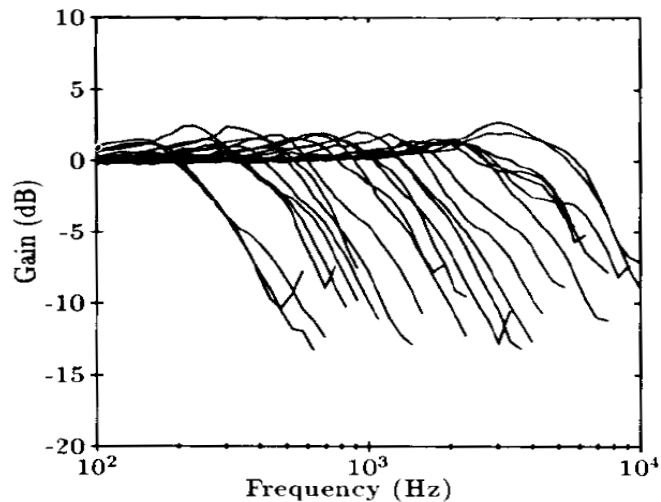

Fig. 8. Floorplan of 100-stage cochlea chip, in serpentine arrangement. The wires that are shown connecting the TAU and Q control terminals of the filter stages are built using a resistive polysilicon line, to act as a voltage divider that adjusts the bias currents in the cascade as an exponential function of distance from the input.



Artificial Cochlea

From acoustic signal sensing to spike encoding

Tous droits réservés

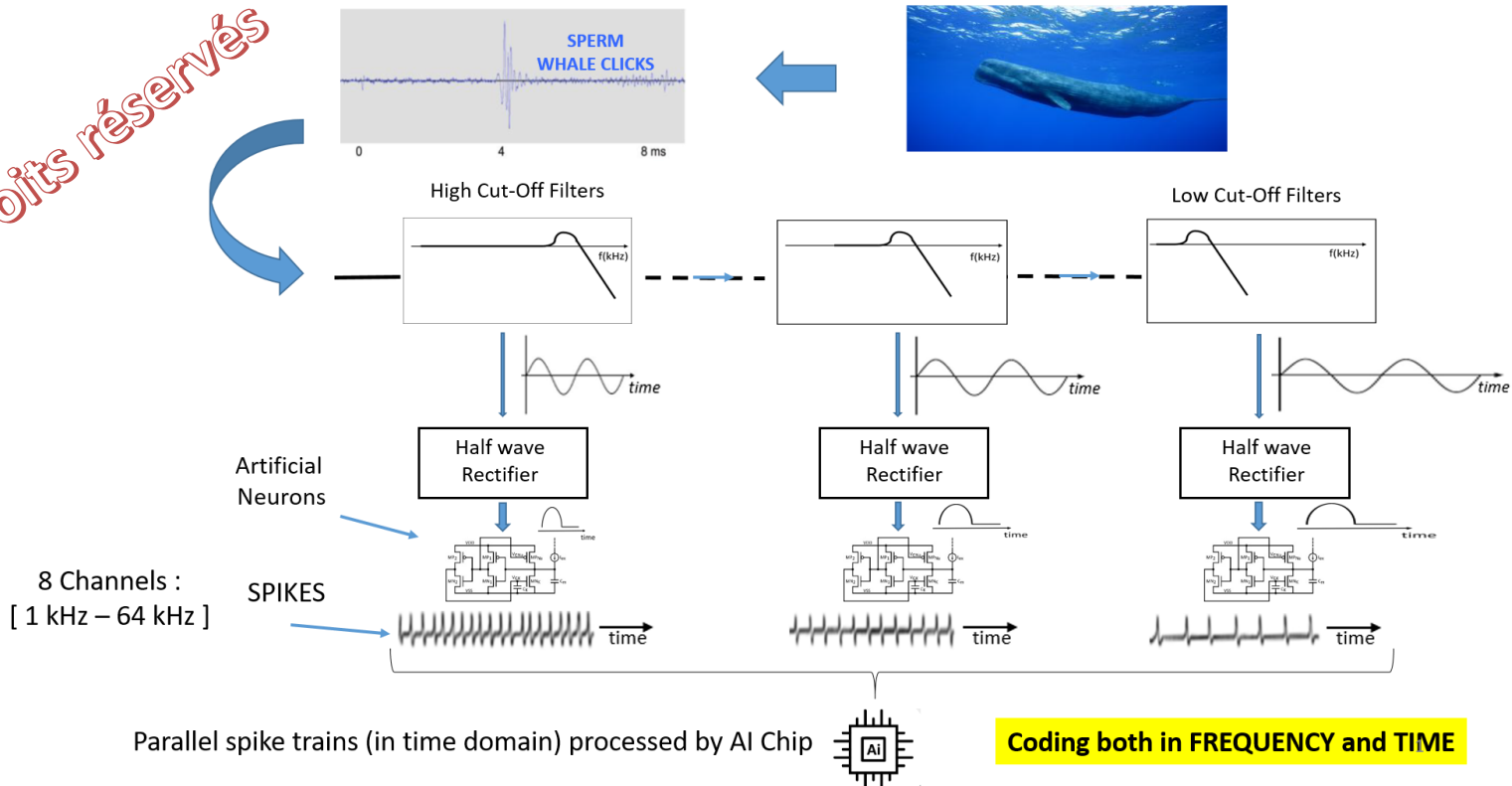

Artificial Cochlea

Cascade of Filters

Tous droits réservés

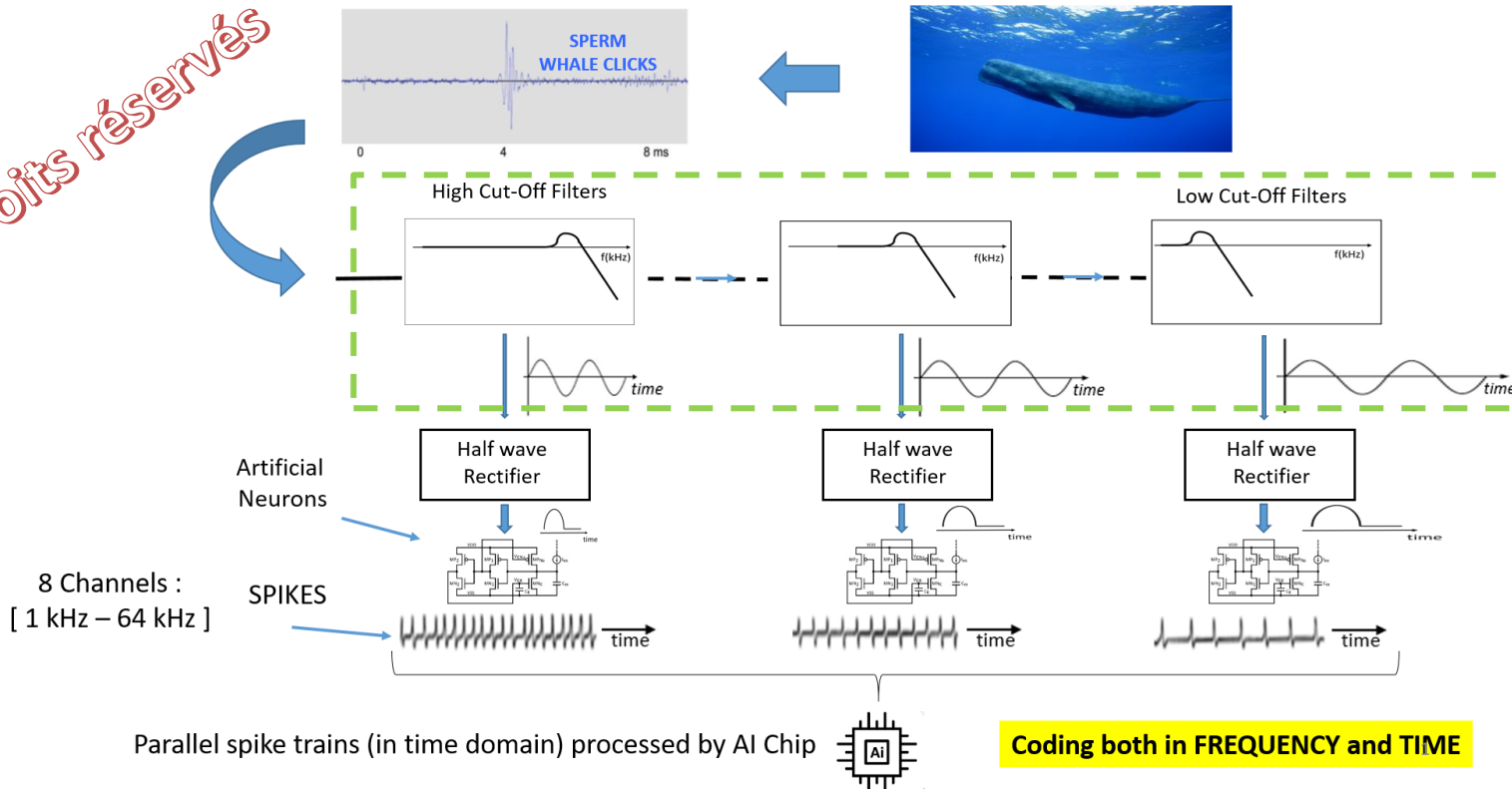

Artificial Cochlea

Cascade of Filters

Tous droits réservés

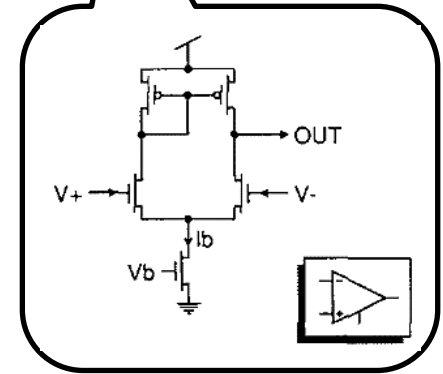
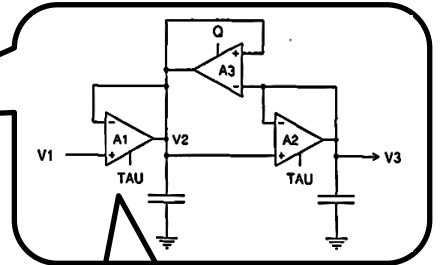
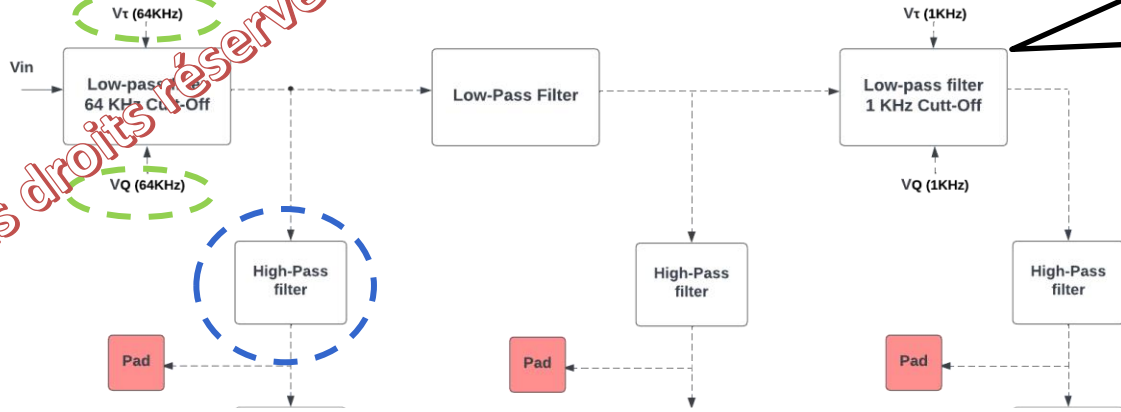

Artificial Cochlea

Conversion to spikes ?

Tous droits réservés

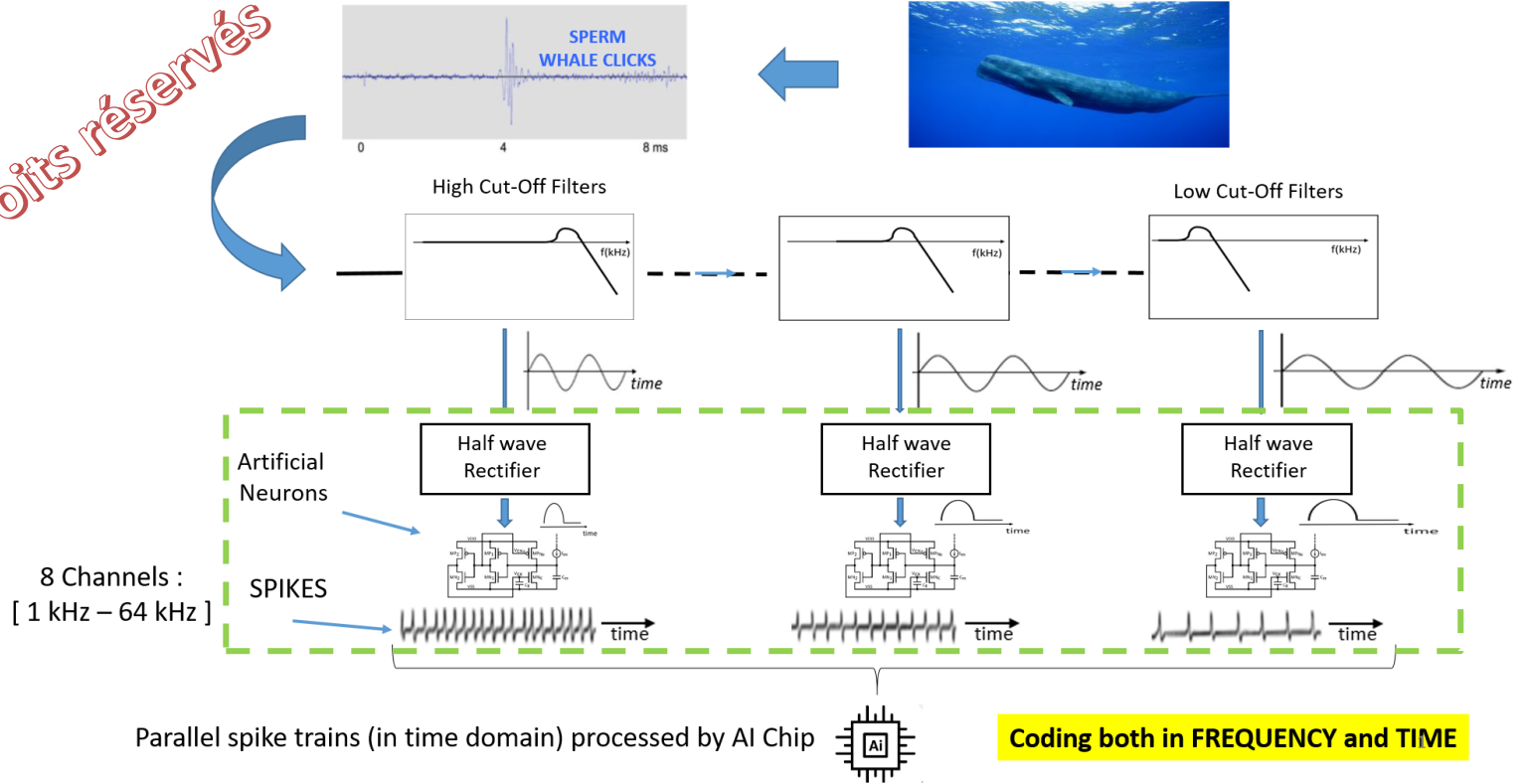

Artificial Cochlea

Artificial Neuron*

Silicon transistor circuit

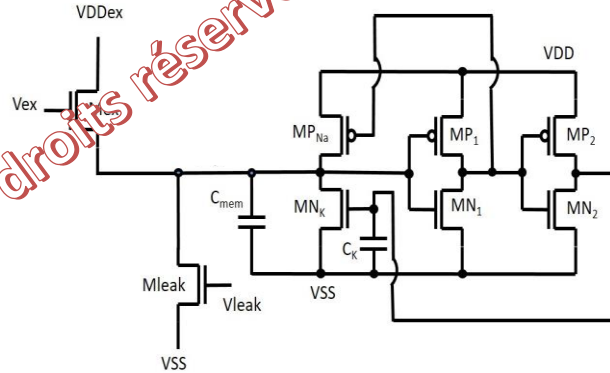

Tous droits réservés

Vmem

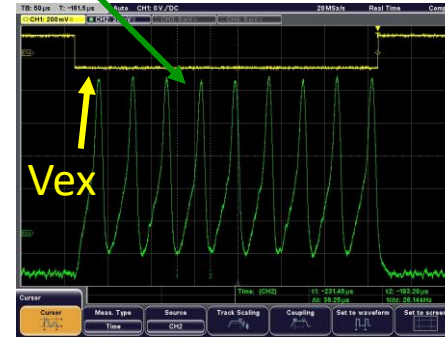

~ 100 mV
(as in biology)

time

Power Consumption < 100 pW

* Patent, FR3050050 A1, 13/10/2017 (INPI)

Artificial Cochlea

Half Wave Rectifier ?

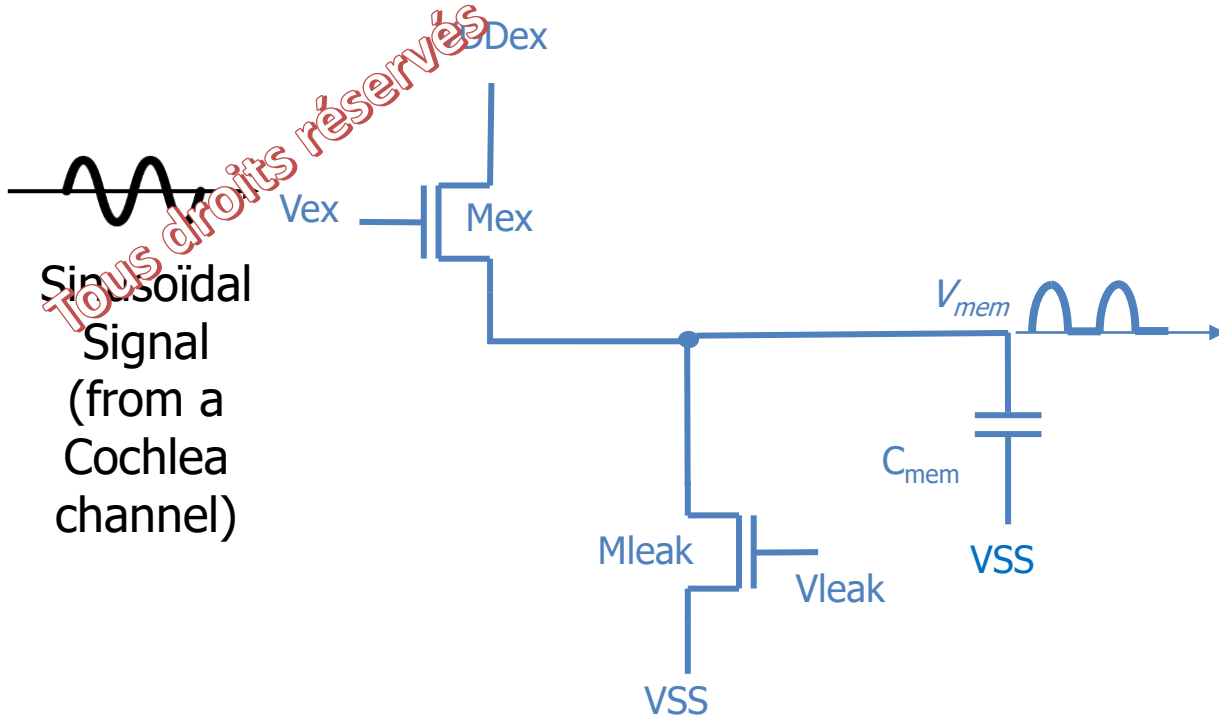

V_{mem} turns to be a half wave signal

Artificial Cochlea

Conversion to spikes ?

Tous droits réservés

Sinusoidal
Signal
(from a
Cochlea
channel)

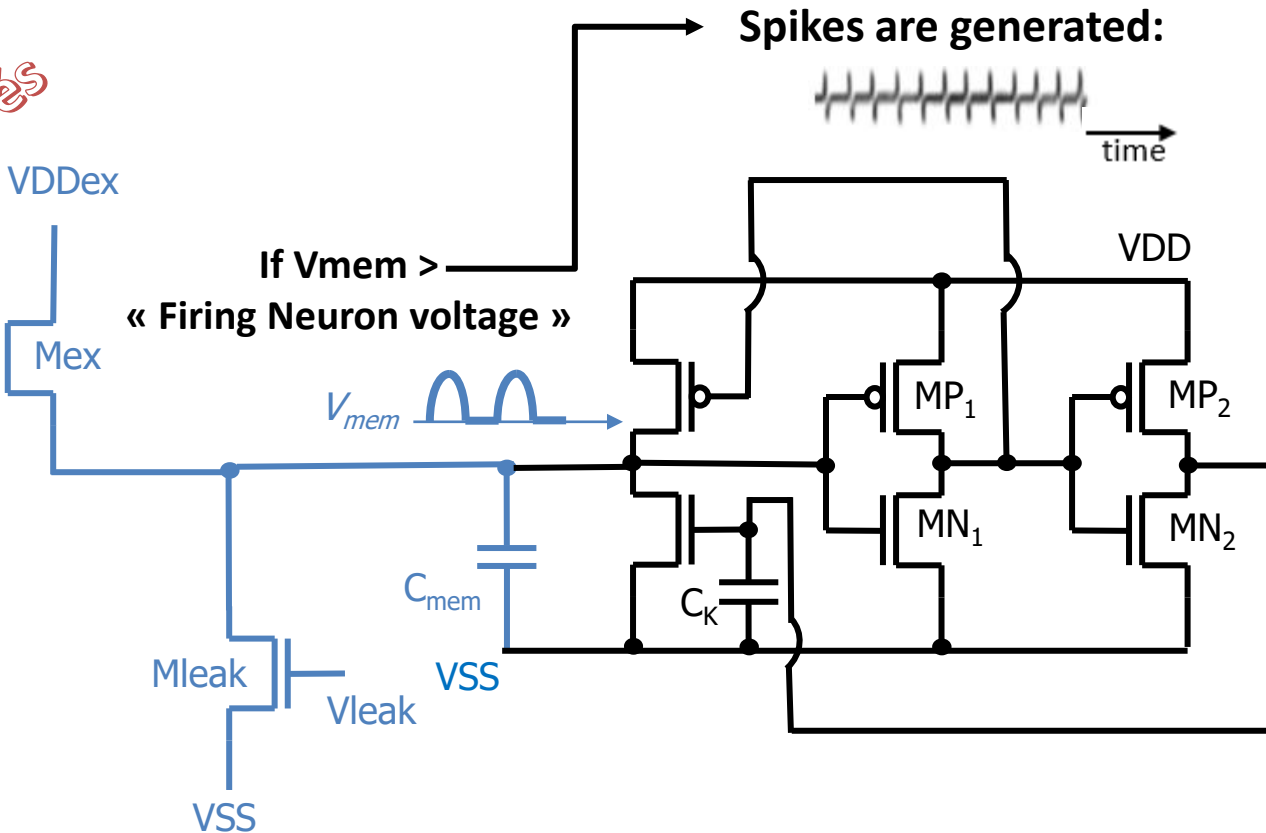

Implementation in CMOS TSMC 65nm Technology

ULP SMART

Layout (Cadence)

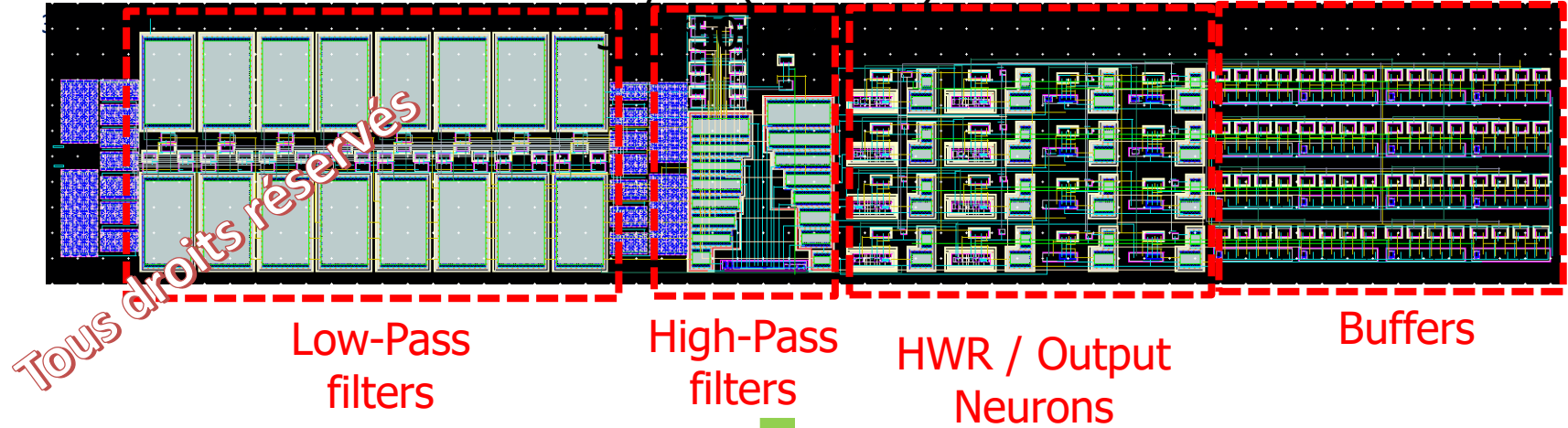

CMOS Microchip $1500 \times 250 \mu\text{m}^2$



8 Output Channels

Tous droits réservés

Simulated results

Artificial Cochlea

Cascade of Filters:

Frequency Channels (kHz) : 0.5-1-2-4-8-16-32-64

Tous droits réservés

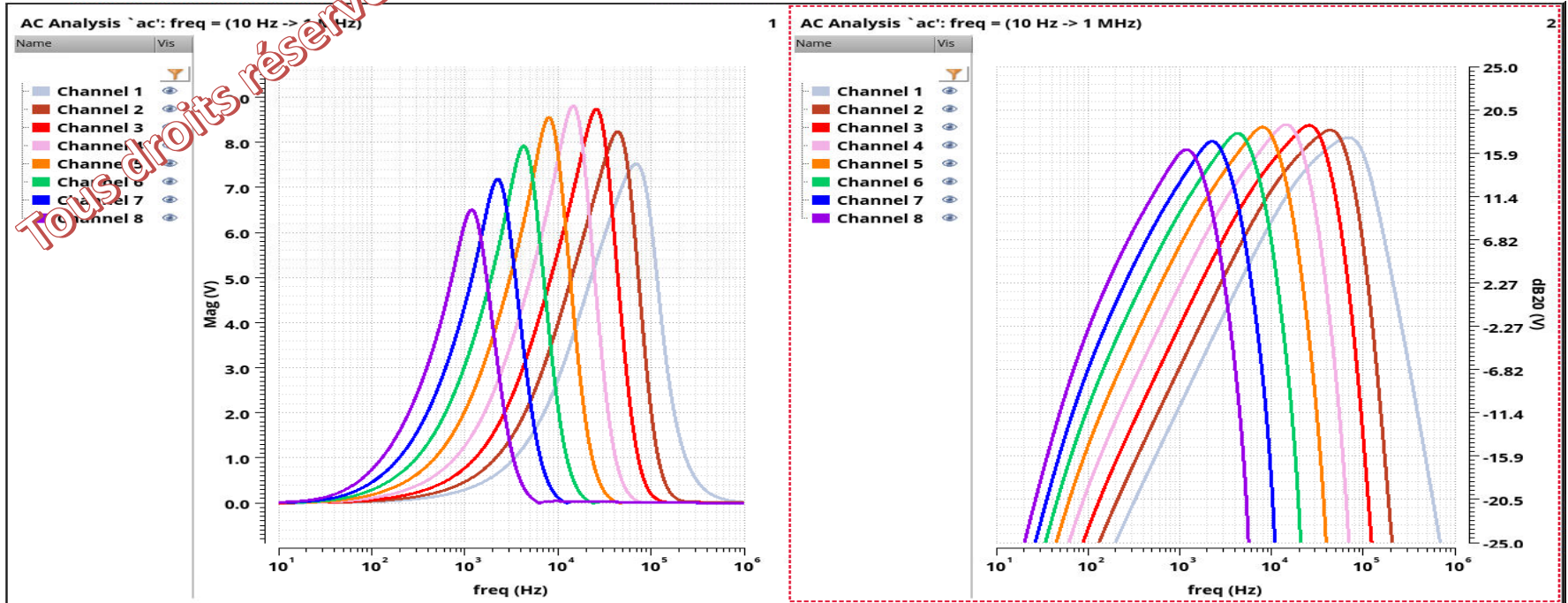

Artificial Cochlea

Conversion to spikes

Tous droits réservés

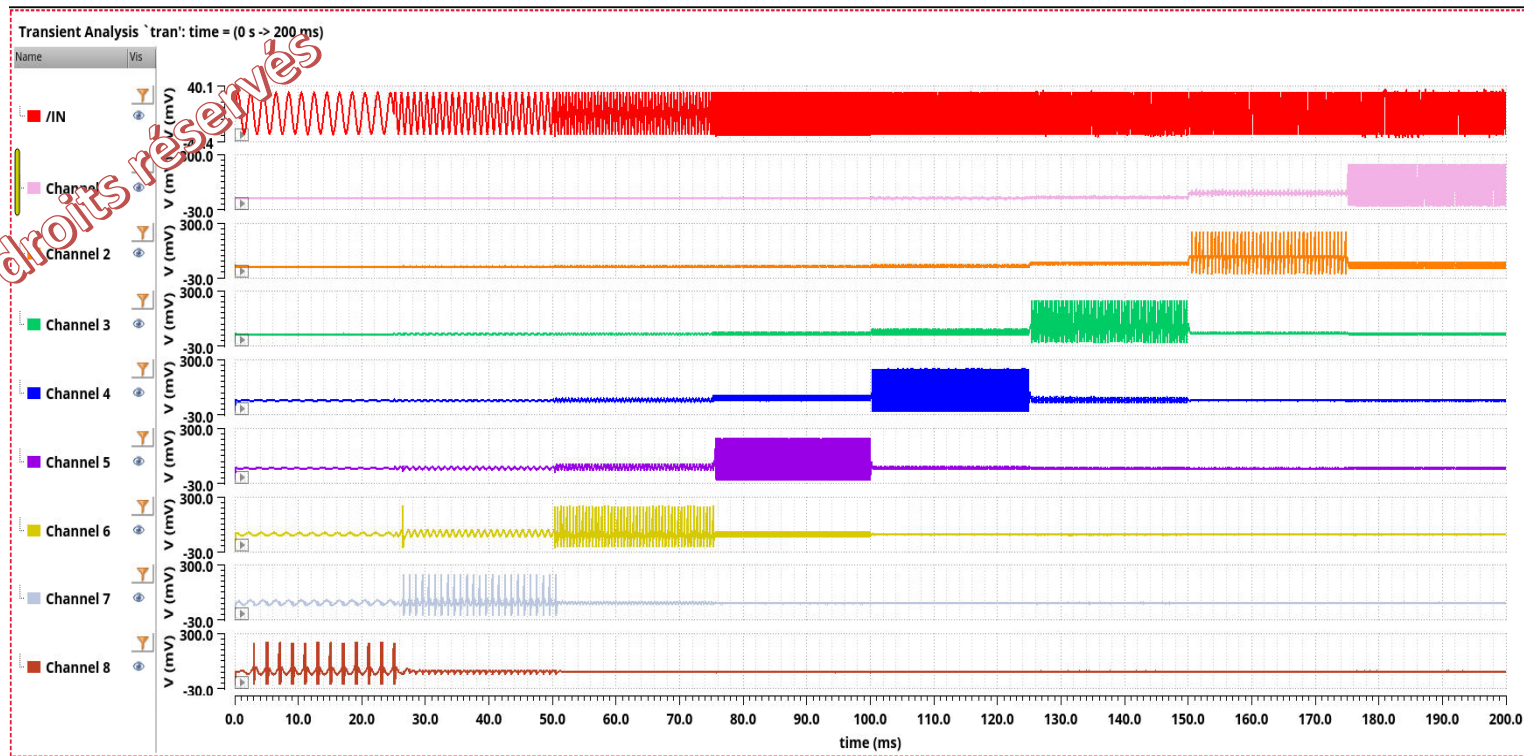

Artificial Cochlea: Simulation / Experimental results

Tous droits réservés

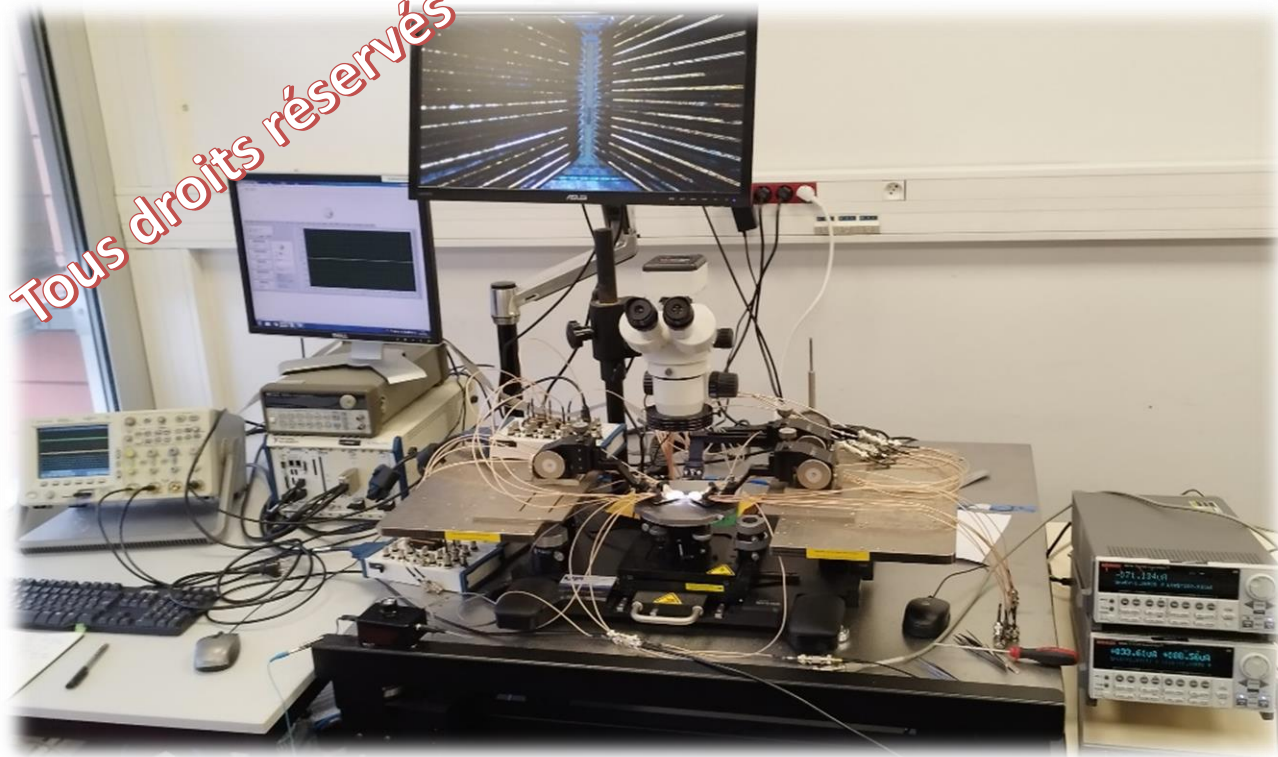

Characterization :
Use of a probe station

Acoustic (natural) Signal of two Ceteceans

ULP SMART
3D COCHLEA



Sperm Whale clicks : Discovery of Sound in the Sea

<https://dosits.org/galleries/audio-gallery/marine-mammals/toothed-whales/sperm-whale>



Rough-toothed Dolphin clicks : DCLDE Oahu

<https://www.soest.hawaii.edu/ore/dclde/>

Tous droits réservés

Acoustic (natural) Signal of two Ceteceans

UL SMART
3D

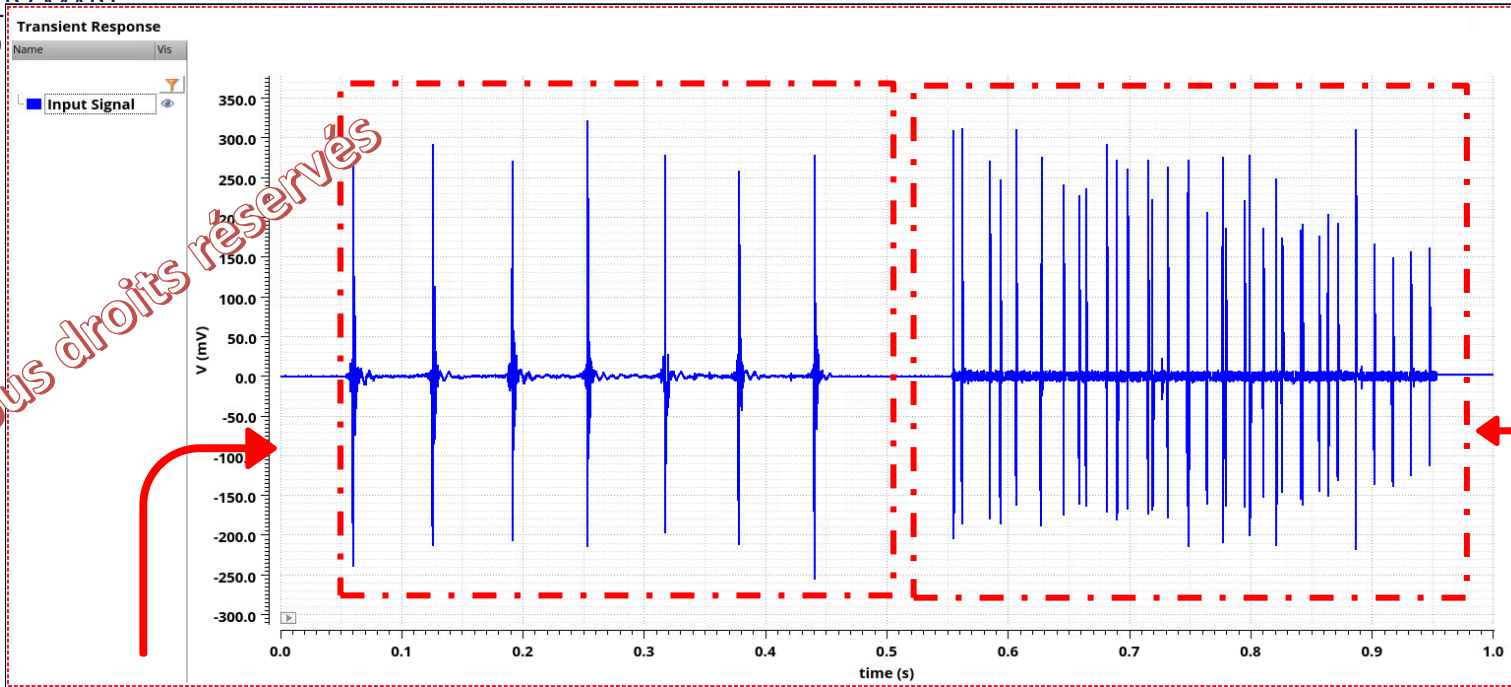

Tous droits réservés

Sperm Whale
(*Physeter macrocephalus*)



The rough-toothed
dolphin
(*Steno bredanensis*)

Sperm Whale clicks

ULP SMART
3D COCHLEA

Tous droits réservés

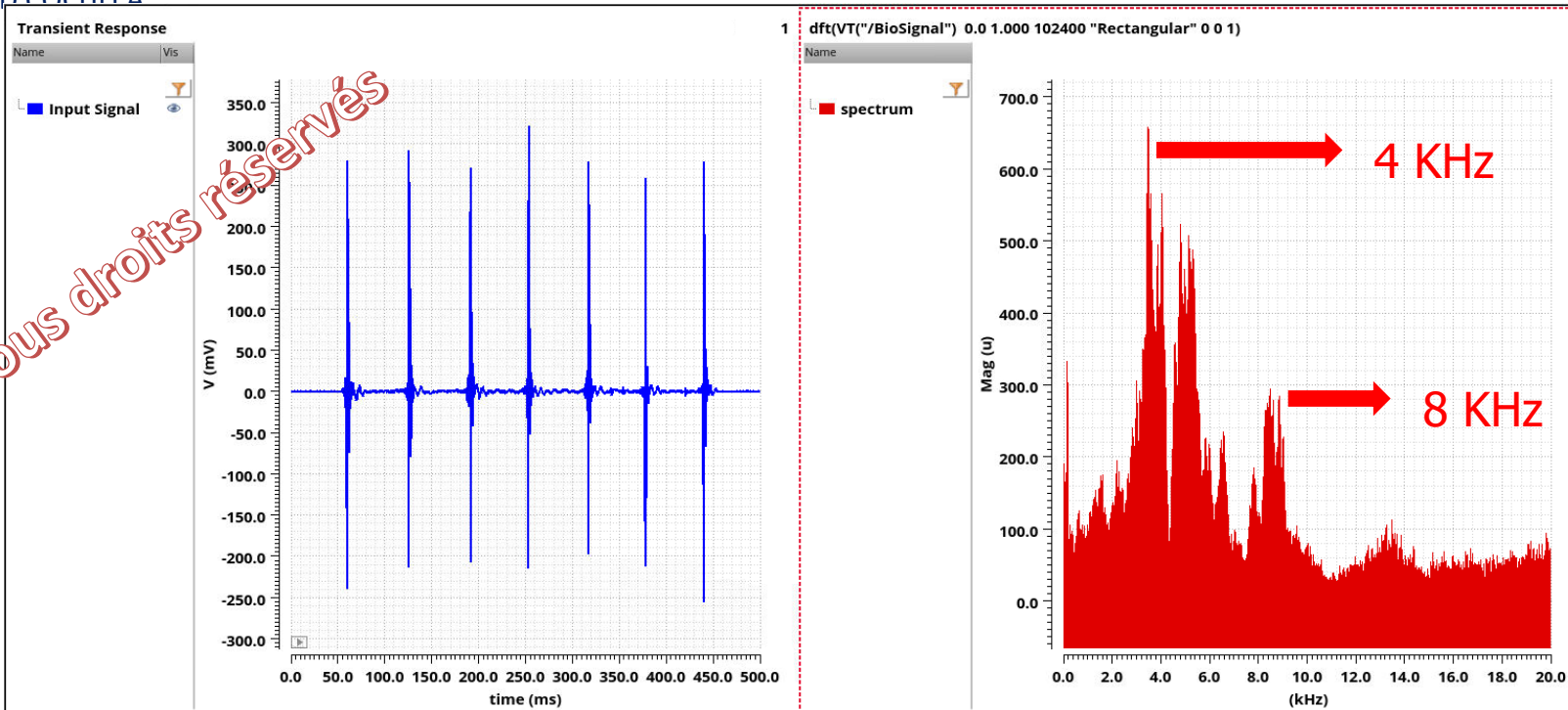

Sperm whale clicks : spectrum

Response of the Cochlea to Sperm Whale Clicks (simulation in CADENCE)

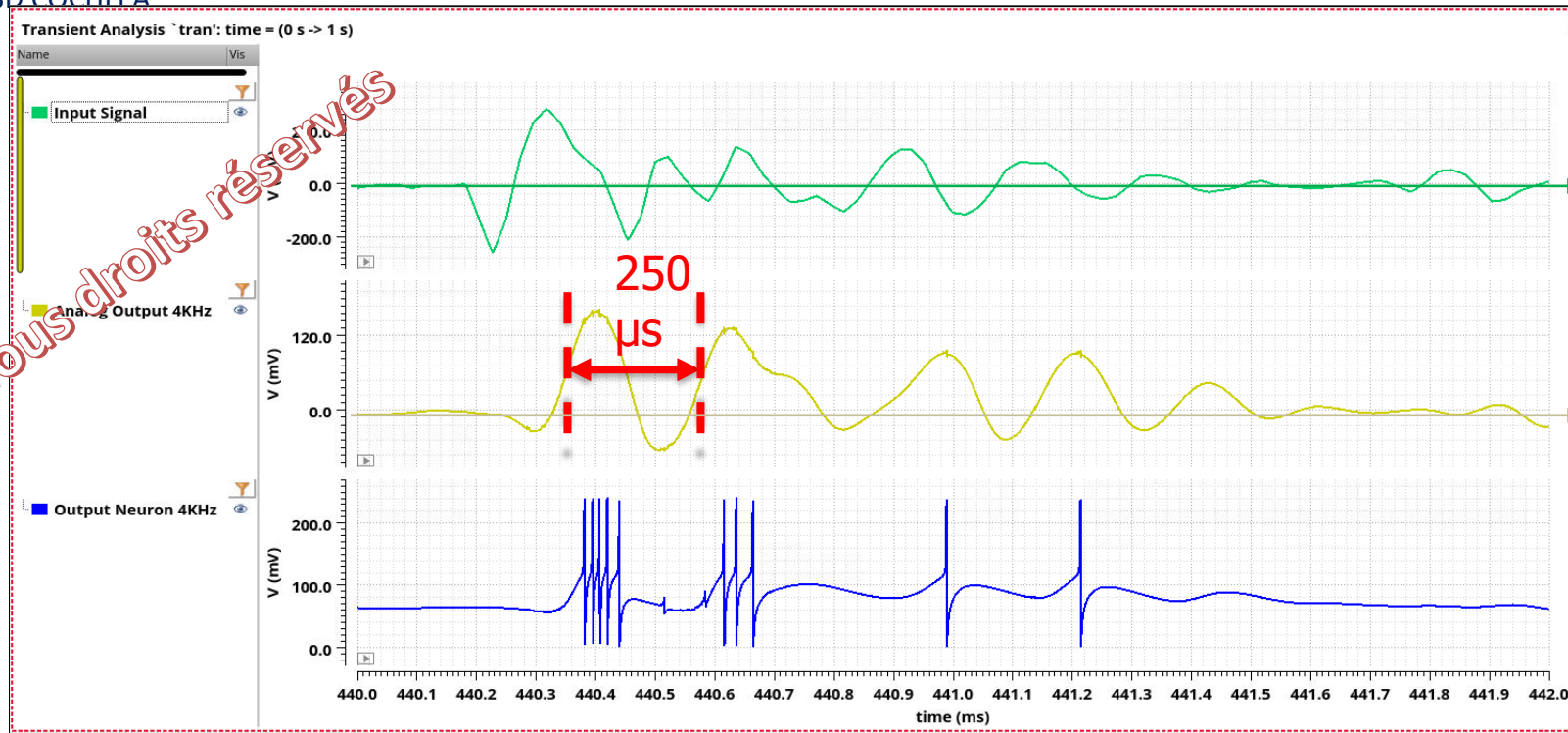
ULP SMART
3D COCHLEA

Transient response of the cochlea to a single Sperm Whale click (4KHz Channel)

Response of the Cochlea to Sperm Whale Clicks (simulation in CADENCE)

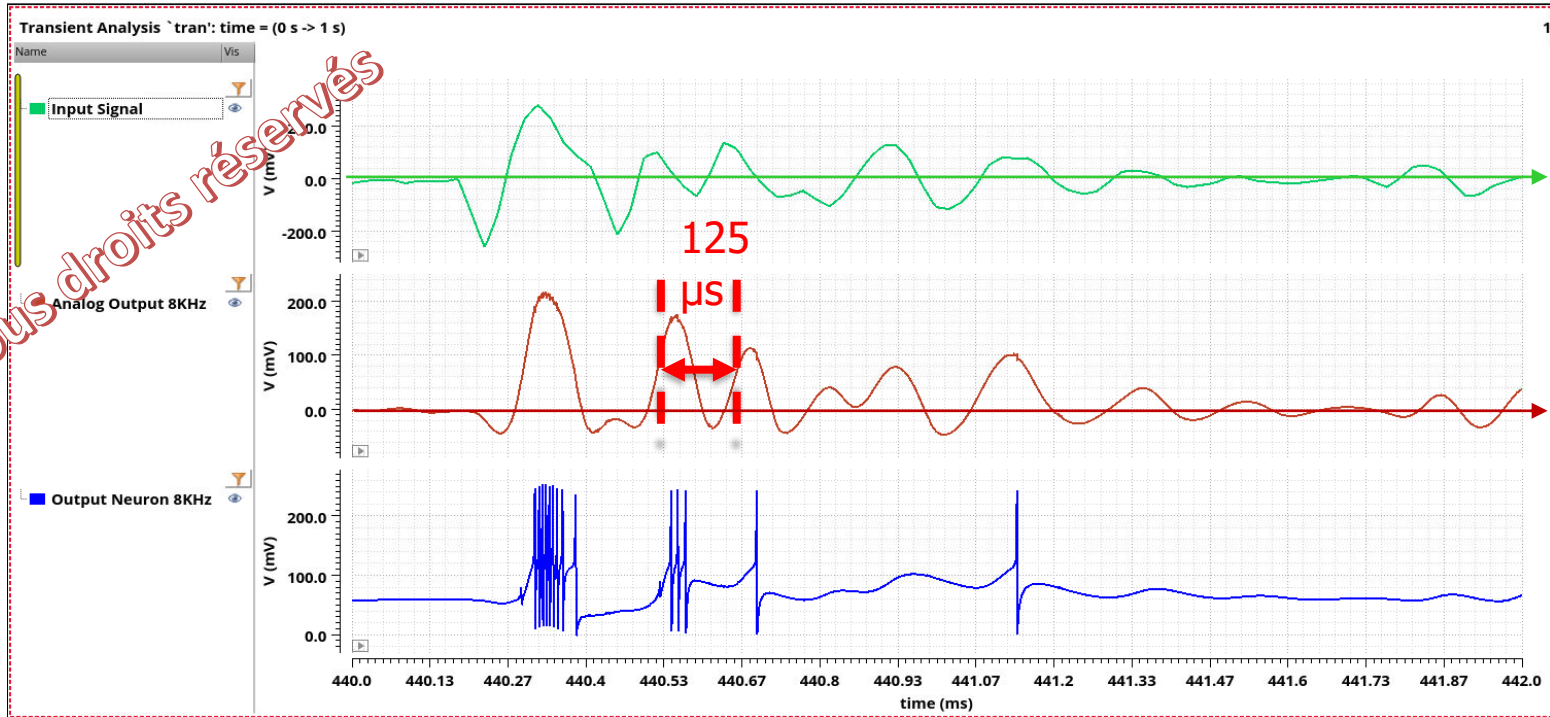

Transient response of the cochlea to a single Sperm Whale click (8KHz Channel)

Response of the Cochlea to Sperm Whale Clicks (simulation in CADENCE)

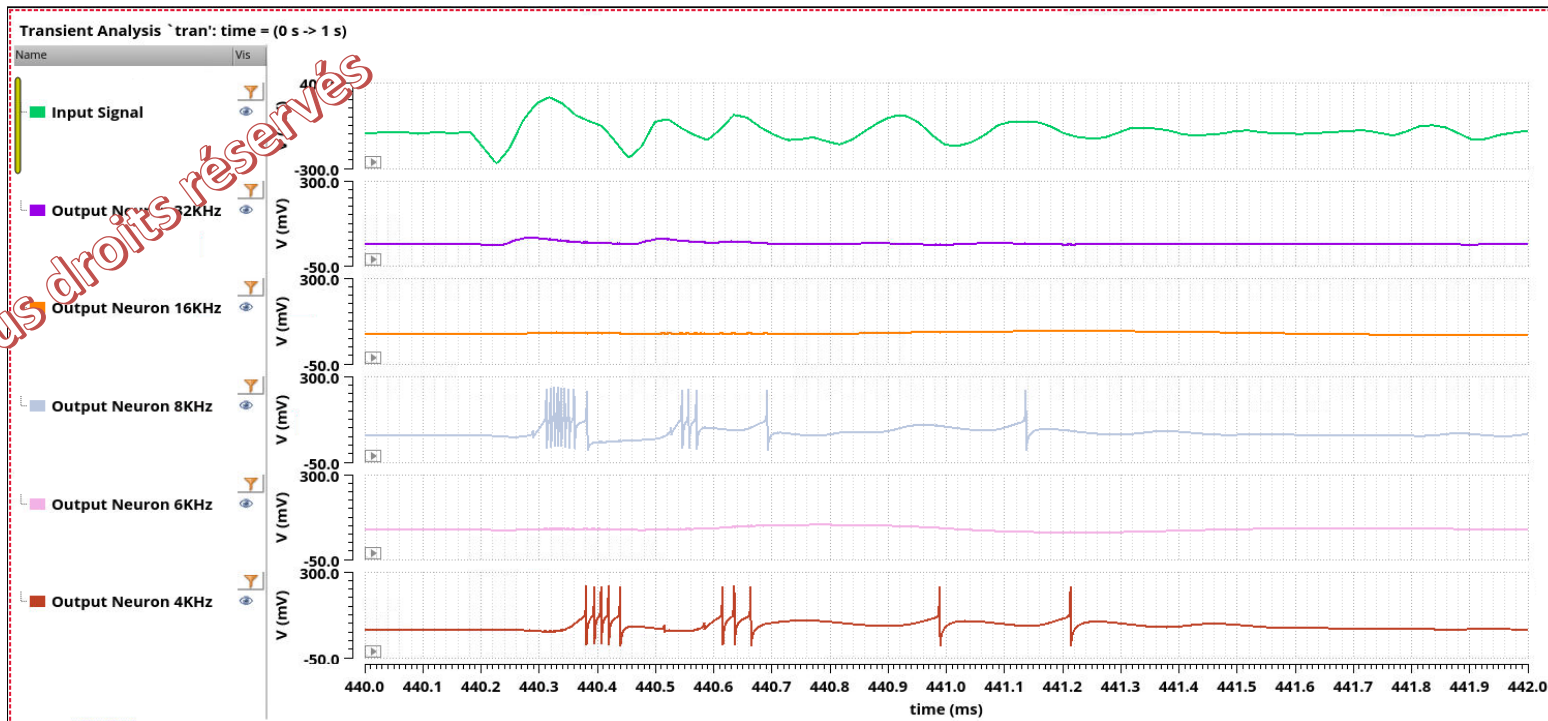
ULP SMART
3D COCHLEA

Transient response of the cochlea to a single Sperm Whale click (All Channels)

Response of the Cochlea to Sperm Whale Clicks (simulation in CADENCE)

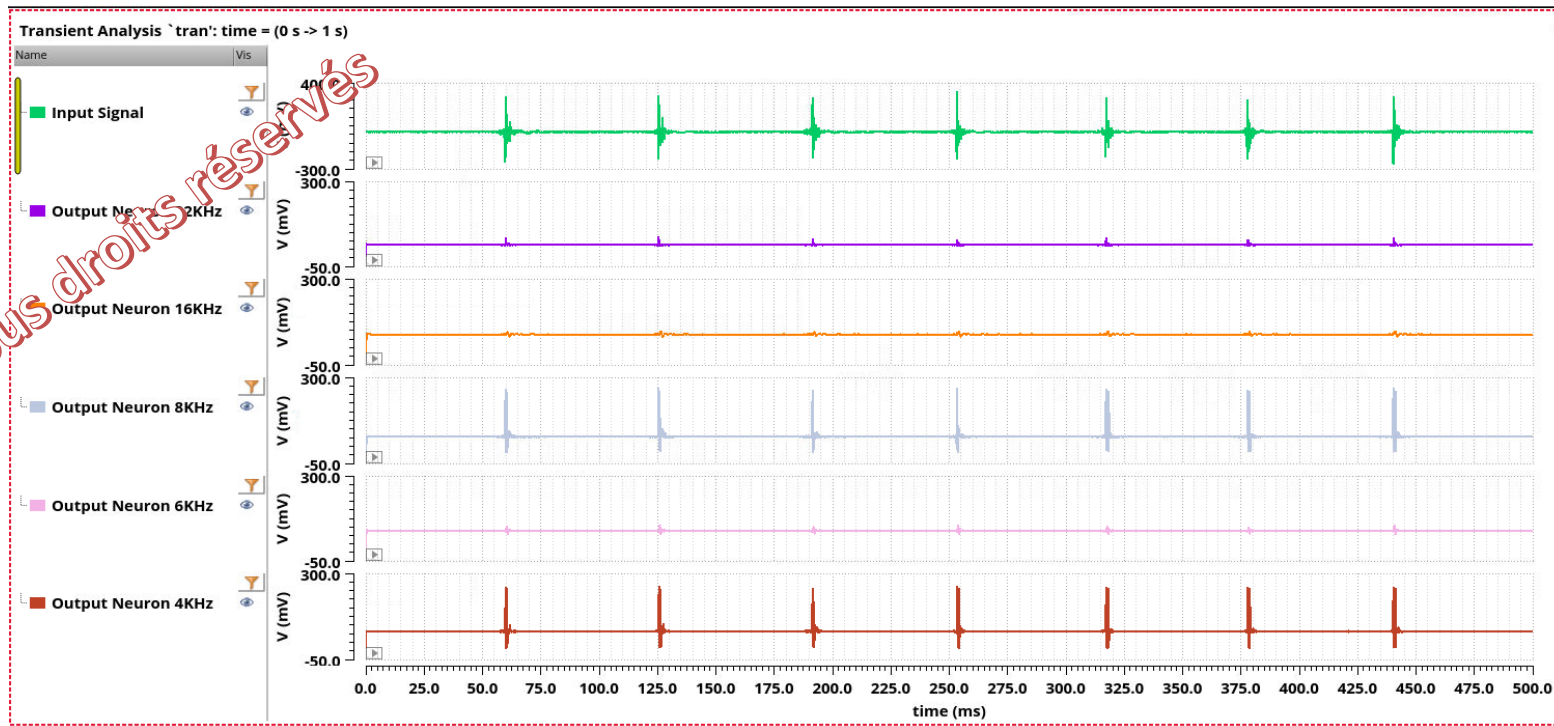
ULP SMART
3D COCHLEA

Transient response of the cochlea to a train of Sperm Whale clicks (All Channels)

Response of the Cochlea to Sperm Whale Clicks (Experimental results)

ULP SMART
3D COCHLEA

Agilent Technologies

TUE OCT 24 17:13:08 2023

Tous droits réservés

250µs

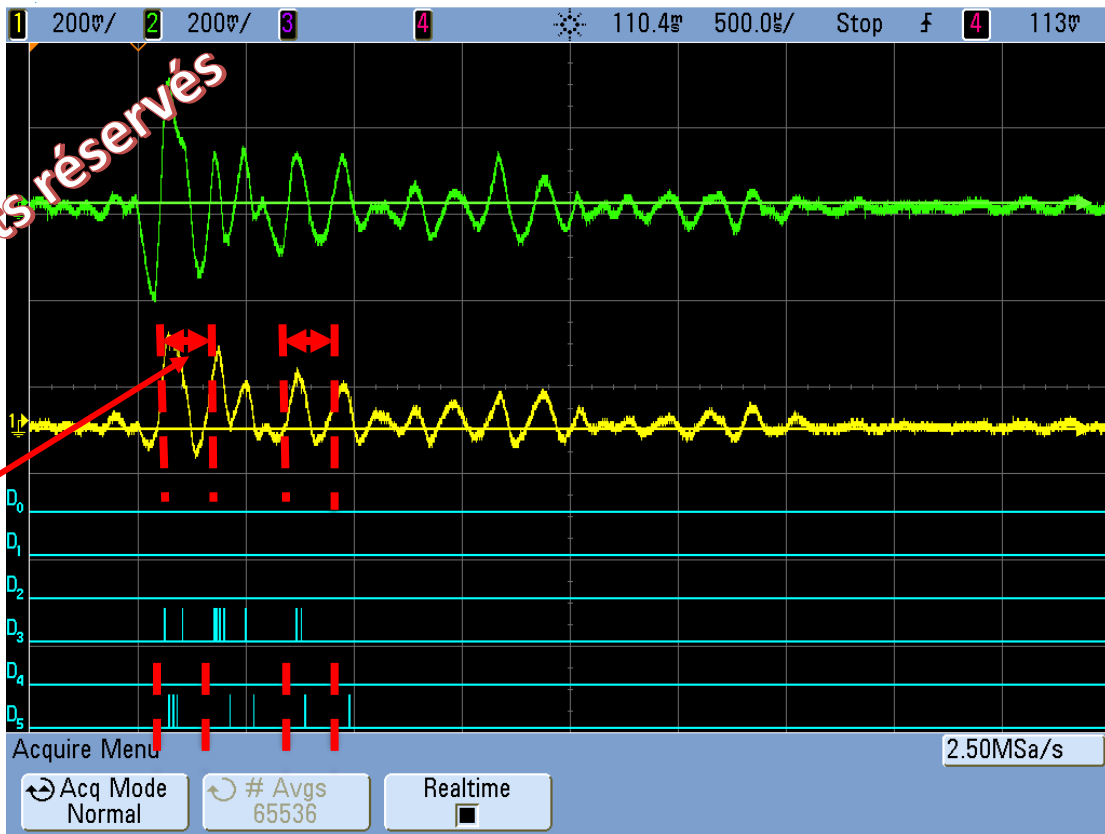

← Sperm Whale click

Single output of Filters bank available

← Analog output 4KHz

← 32KHz Channel

← 8KHz Channel

← 4KHz Channel

Response of the Cochlea to Sperm Whale Clicks (Experimental results)

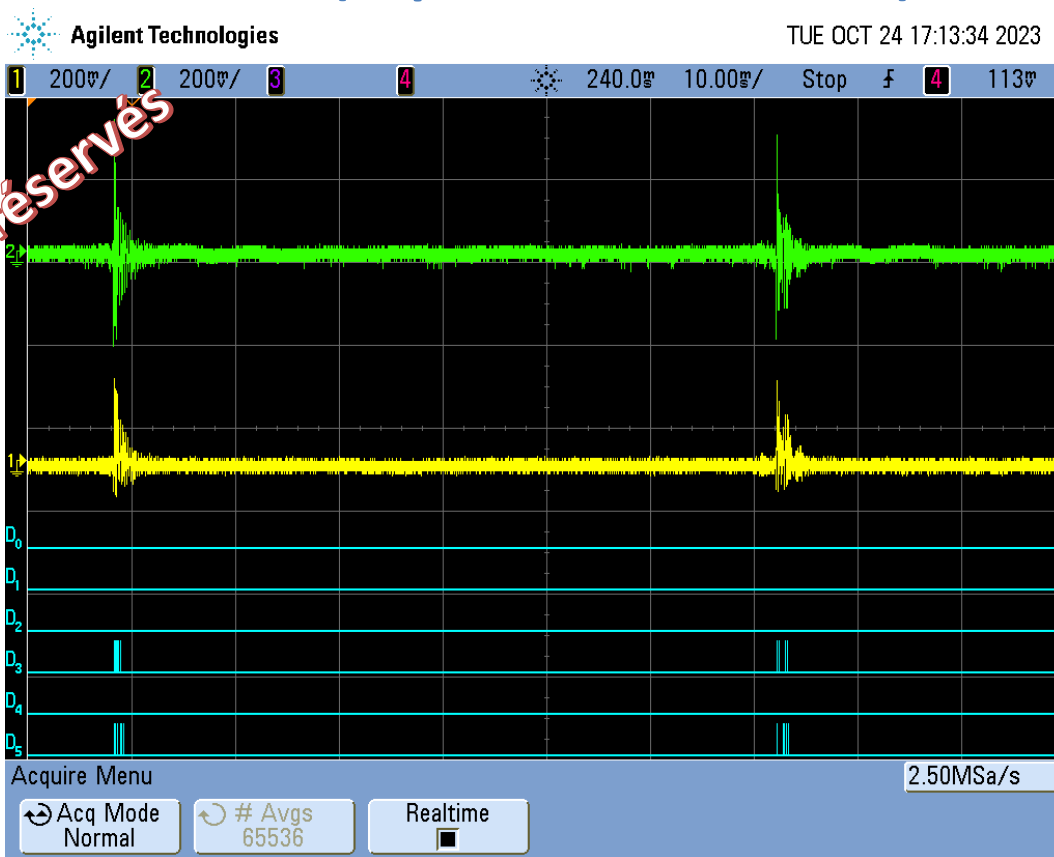

Tous droits réservés

- ← Sperm Whale click
- ← Analog output 4KHz
- ← 32KHz Channel
- ← 8KHz Channel
- ← 4KHz Channel

Dolphin clicks

ULP SMART
3D COCHLEA

Tous droits réservés

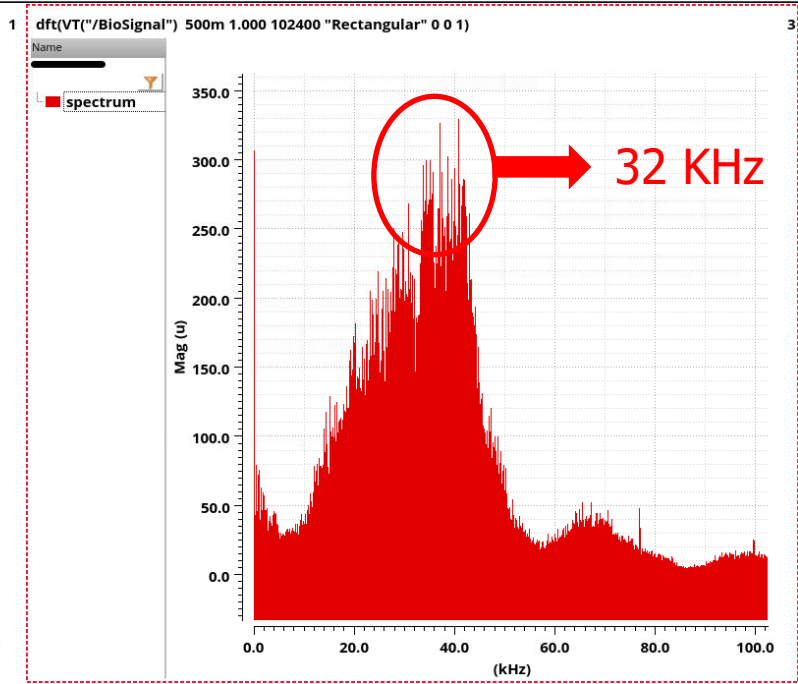
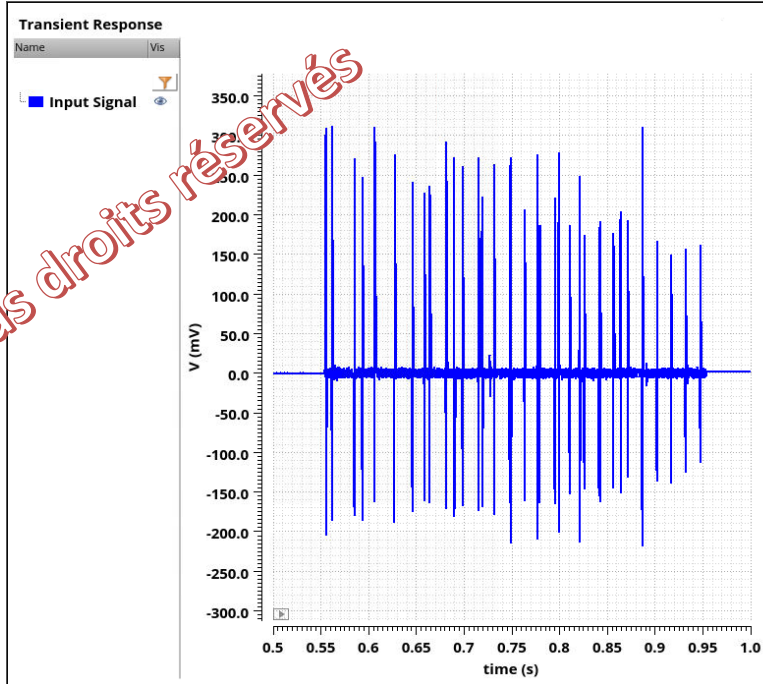

Dolphin clicks: spectrum

Response of the Cochlea to Dolphin Clicks (simulation in CADENCE)

ULP SMART
3D COCHLEA

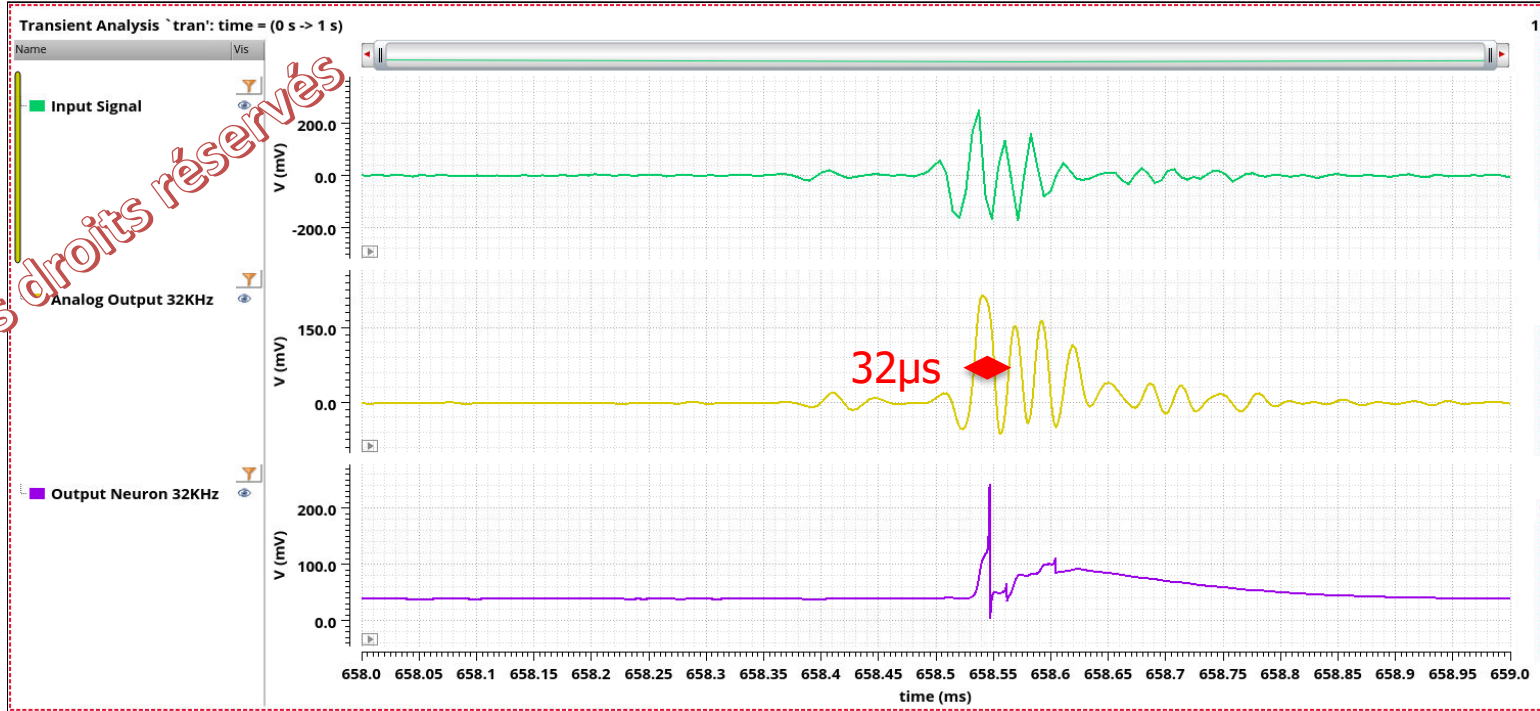

Transient response of the cochlea to a single Dolphin click (32KHz Channel)

Response of the Cochlea to Dolphin Clicks (simulation in CADENCE)

ULP SMART
3D COCHLEA

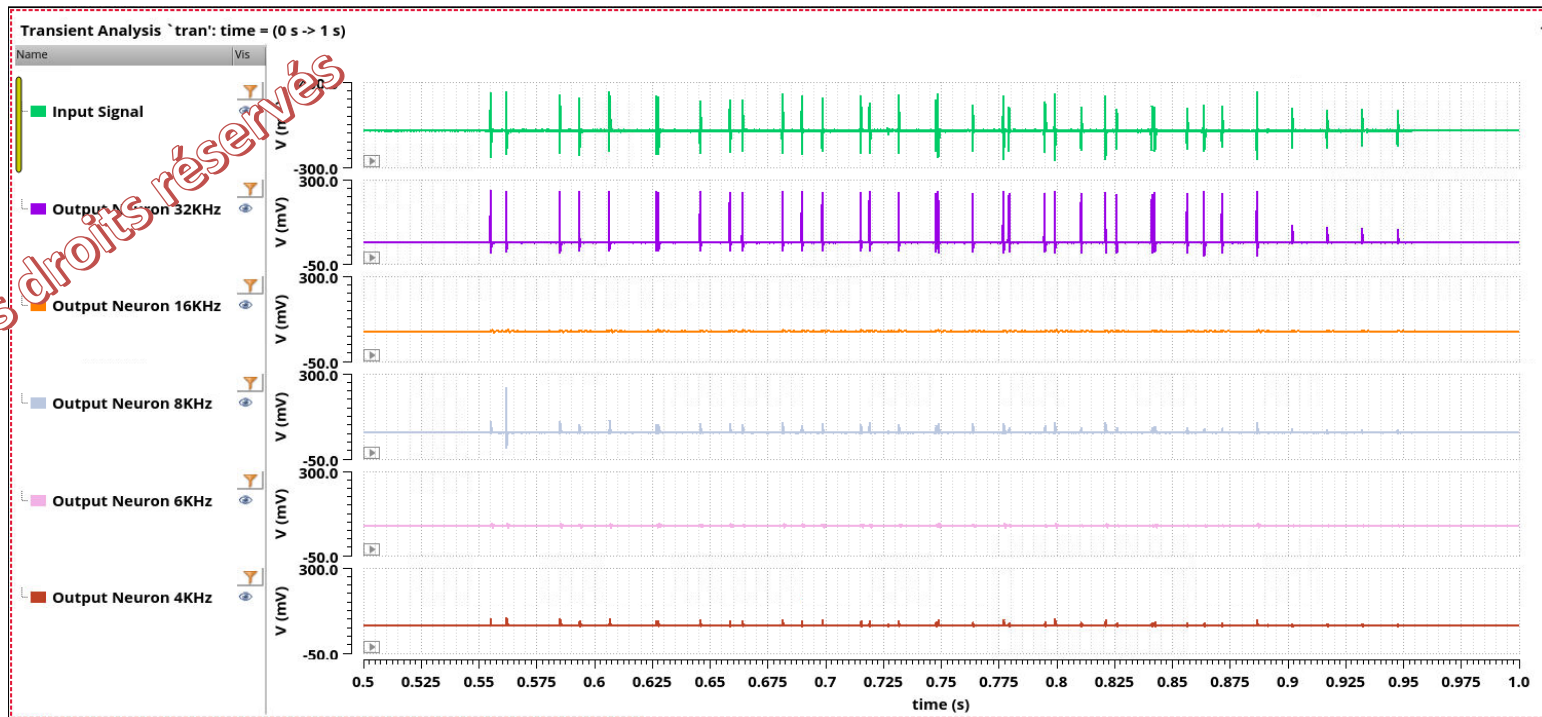

Transient response of the cochlea to a train of Dolphin clicks (ALL KHz Channel)

Response of the Cochlea to Dolphin Clicks (Experimental results)

Tous droits réservés

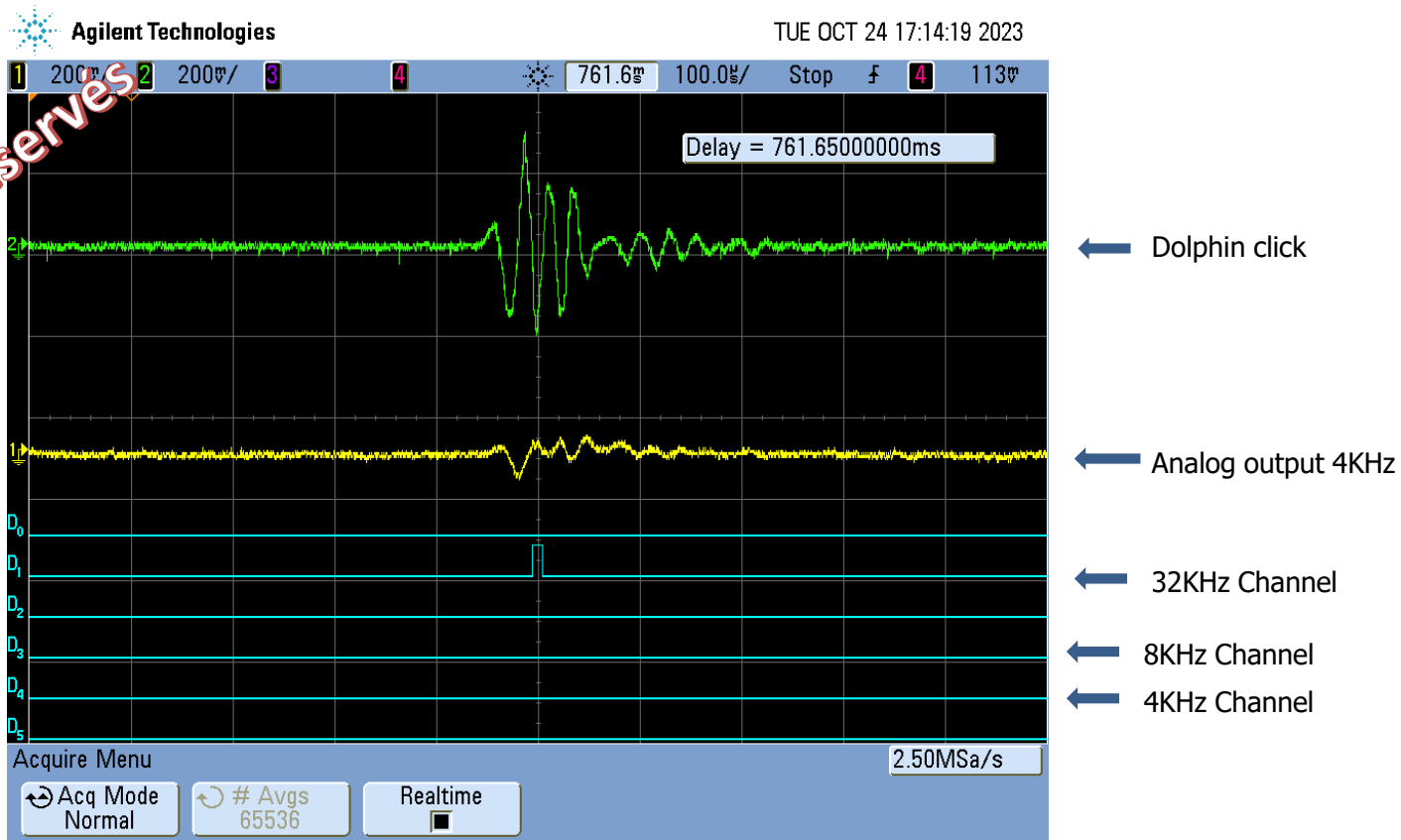

Response of the Cochlea to Dolphin and Sperm Whale clicks (simulation in CADENCE)

Tous droits réservés

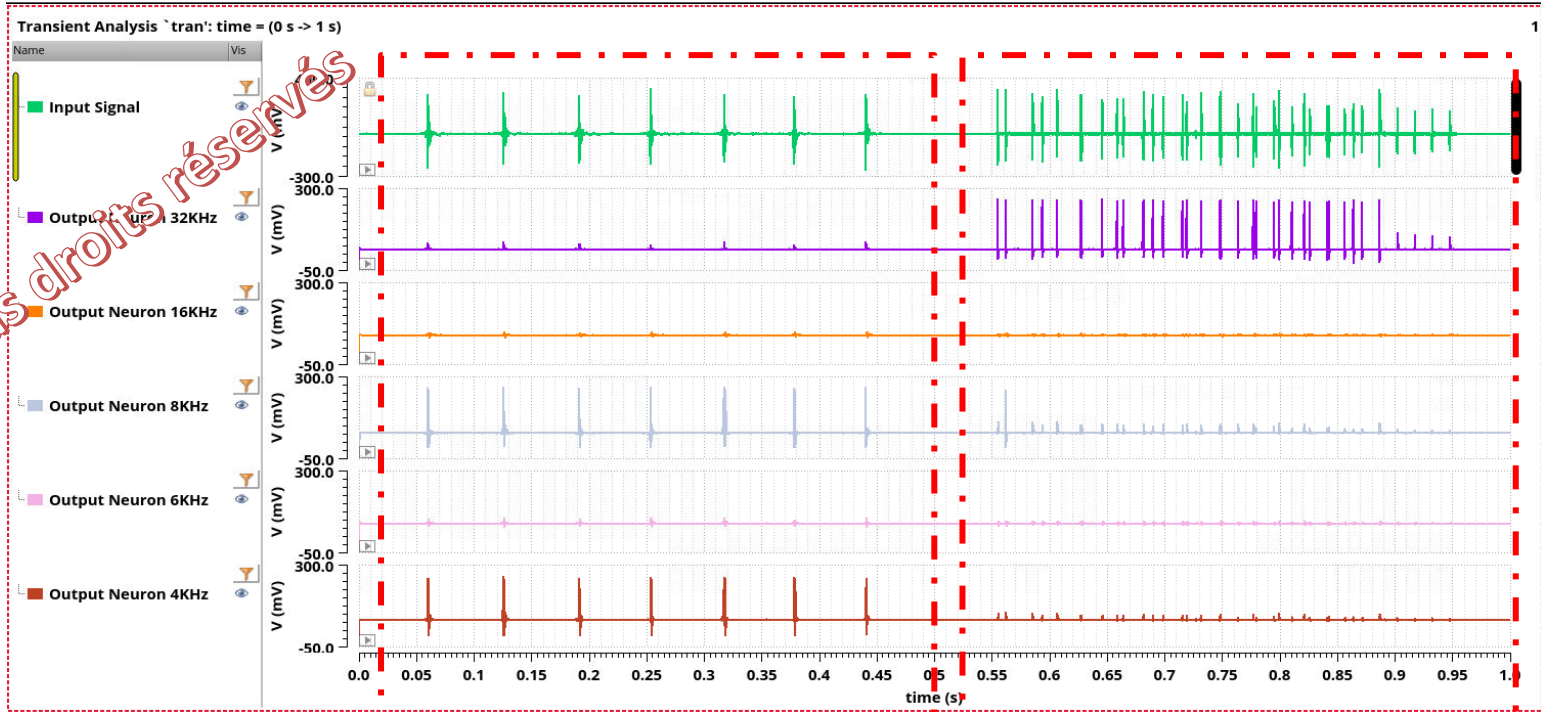

Sperm
Whale

Dolphin

Response of the Cochlea to Dolphin and Sperm Whale Clicks (Experimental results)

Agilent Technologies

TUE OCT 24 17:12:34 2023

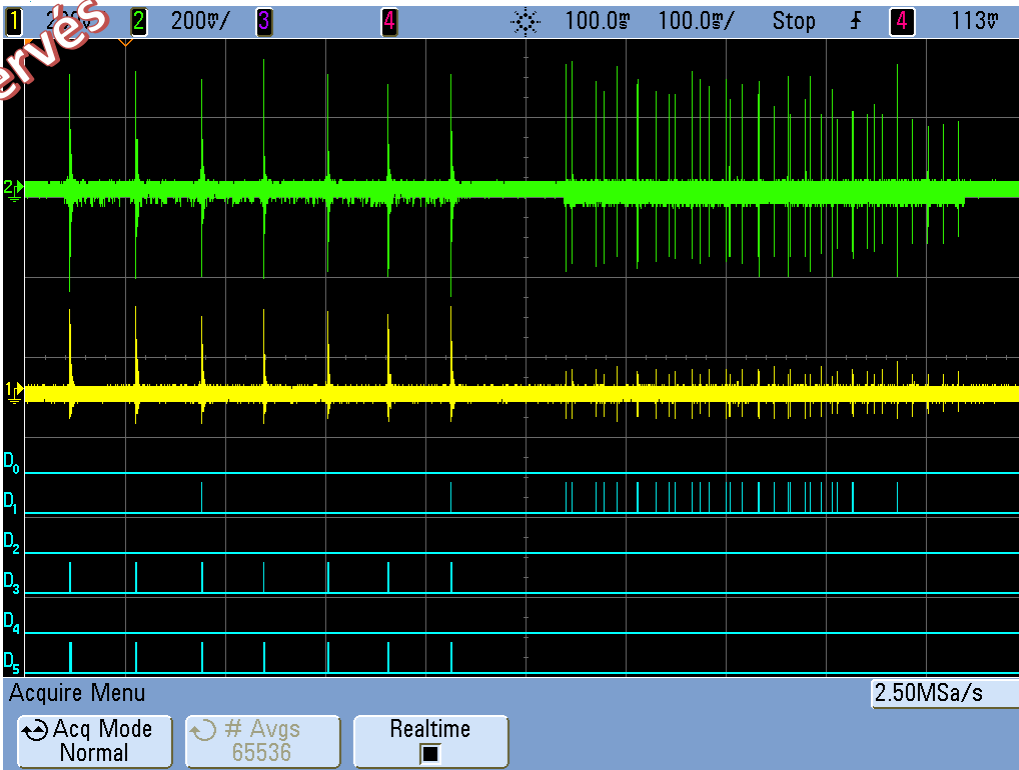

← Acoustic Signal

← Analog output
4KHz

← 32KHz Channel

← 8KHz Channel

← 4KHz Channel

Tous droits réservés

Power consumption ?

CMOS Microchip $1500 \times 250 \mu\text{m}^2$



Tous droits réservés

8 Channels

With buffers (required for characterization) :
~ few microWatts / channel

Without buffers (required for characterization) :
100 nanoWatts / channel

Tous droits réservés

ANR ULP SMART COCHLEA



NEXT ?

Dataset

Tous droits réservés



NEW BEDFORD WHALING MUSEUM

Woods Hole Oceanographic Institution

Watkins Marine Mammal Sound Database

'BEST OF' CUTS ALL CUTS MASTER TAPES ABOUT

The William A. Watkins Collection of Marine Mammal Sound Recordings consists of recordings of various marine mammal species collected over a span of seven decades in a wide range of geographic areas by Watkins and many others. [\[MORE\]](#)

Dataset

10 species selected from the dataset

Tous droits réservés



Beluga, White Whale



False Killer Whale



Atlantic Spotted Dolphin



Bowhead Whale



Clymene Dolphin



Long-Finned Pilot Whale



Melon Headed Whale



Northern Right Whale



Ross Seal



Sperm Whale

Binary Classification : Two classes are used the first class contains several species of marine mammals and the second class corresponds to the killer whale species.

Tous droits réservés

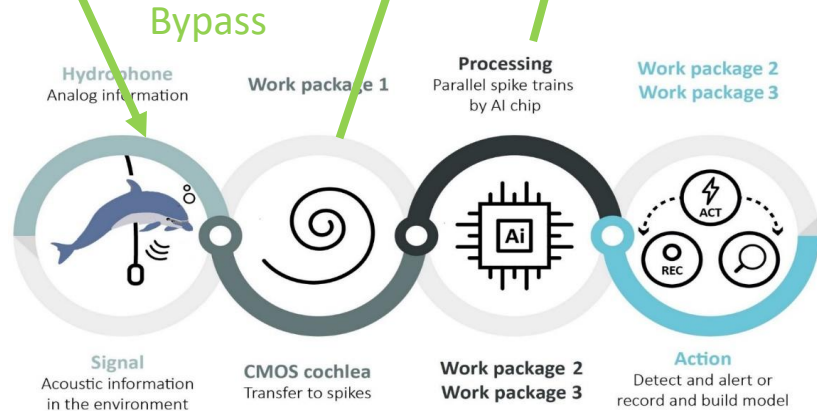
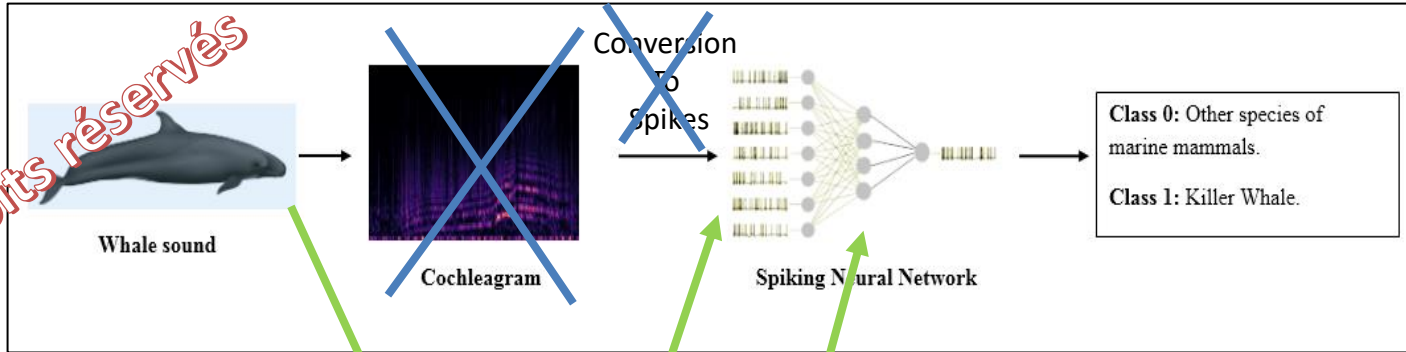

Tous droits réservés

ANR ULP SMART COCHLEA



LOCALIZATION ?

Hi!, where are you located ?



*3D localisation of sperm whales (in the abyss) possible,
using specific algorithms*

Tous droits réservés

(meters)

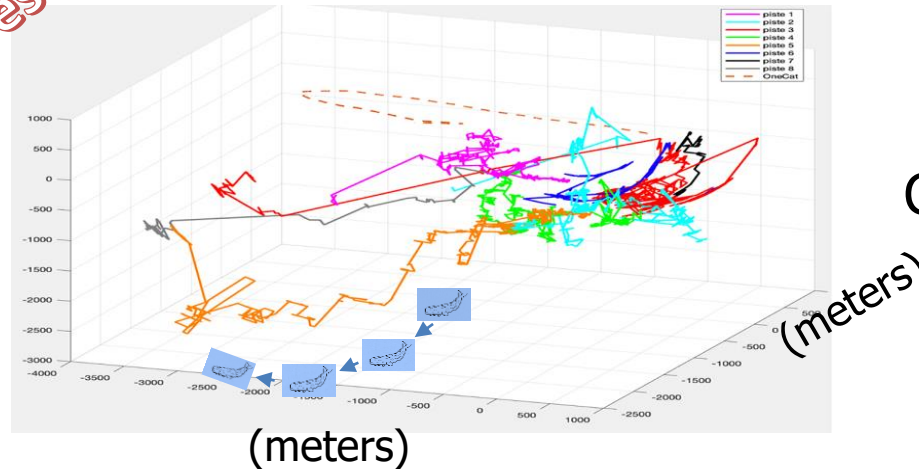

Courtesy: Prof. H. Glotin
Univ. Toulon

*Sphyrna Odyssey 2019-2020 : 3D tracks of 7 sperm whales off Monaco coast,
during 2 hours, hunting in collaboration in the abyss (-1000 à -2000m)*

<https://www.franceinter.fr/emissions/la-terre-au-carre/la-terre-au-carre-29-octobre-2020>

Sound Localization : basics

Tous droits réservés

Left Ear

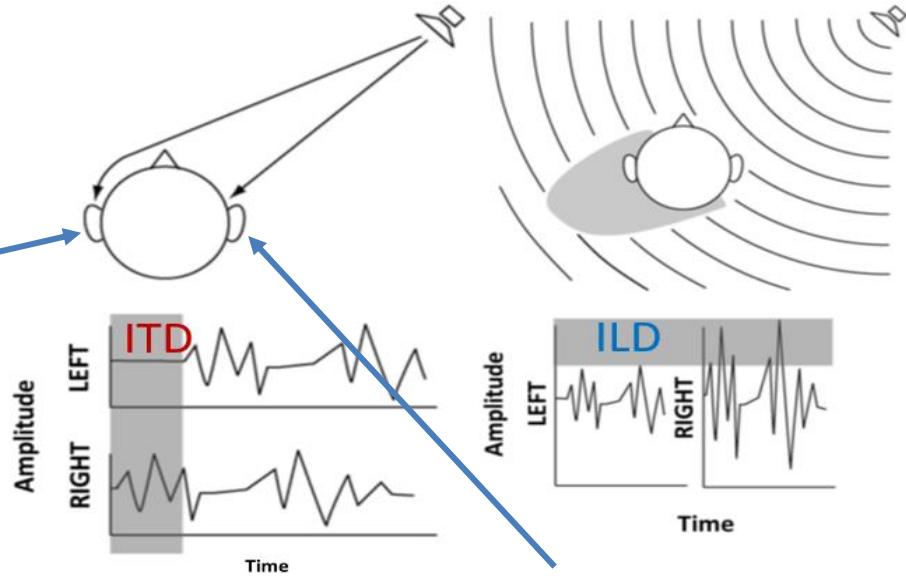

Right Ear

ITD : Interaural Time Difference

ILD : Interaural Level Difference

Sound Localization : how ITD is encoded in biology* ?

Jeffress model

Tous droits réservés

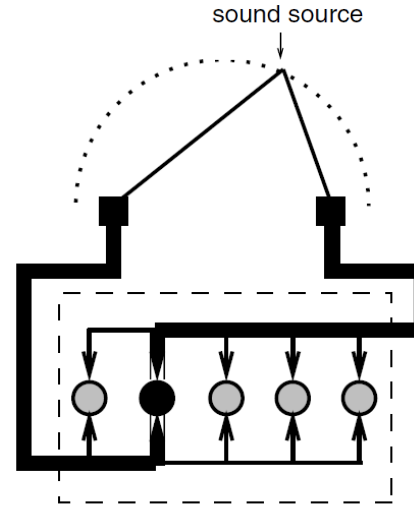
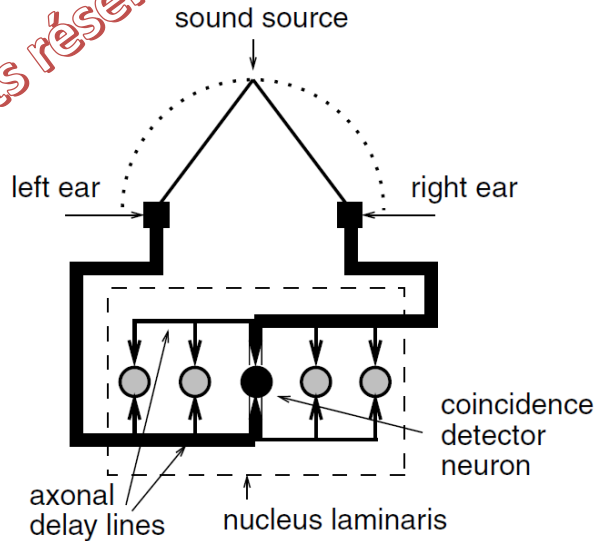

* J. Leo van Hemmen et al, *Problems in Neuroscience*, Oxford University Press, USA, 2006

MOTION DETECTOR :

« Hassenstein-Reichardt » detector (1956)



Tous droits réservés

Luminous spot that moves



Luminous spot that moves

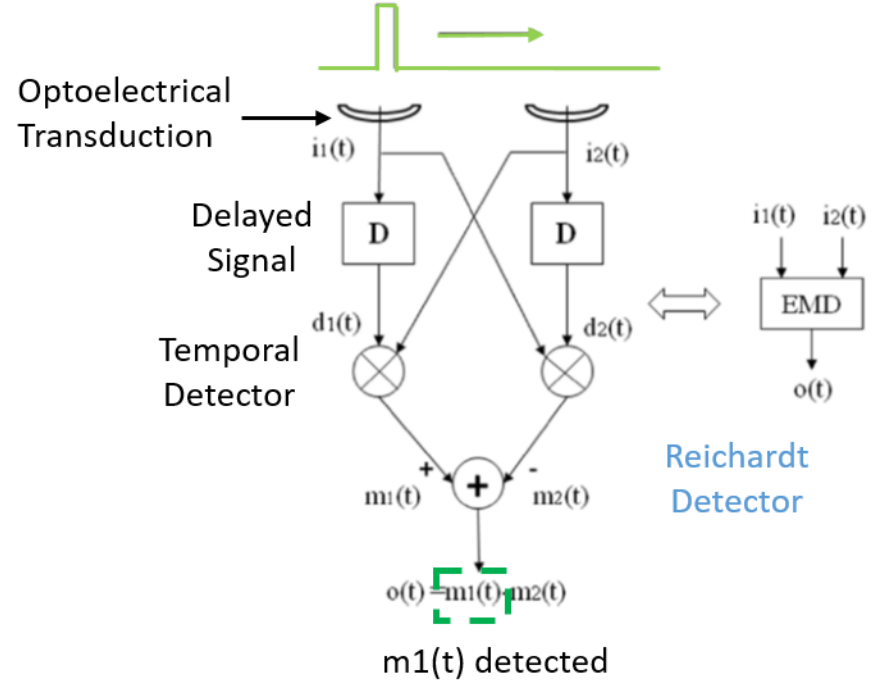

Coincidence Detector*:

coding interaural time difference (ITD),
by (simply) counting spikes

Tous droits réservés

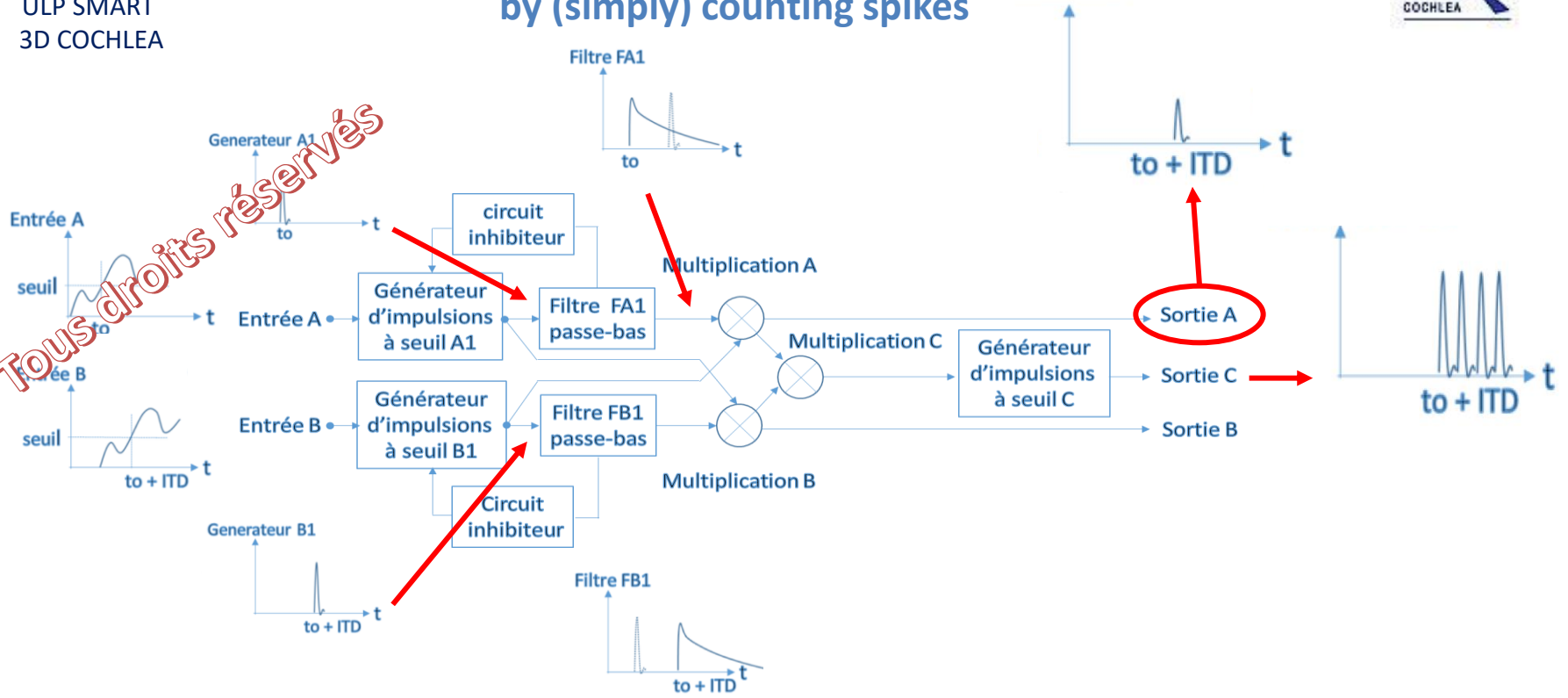

* Patent, FR2112849, 02/12/2021 (INPI)

2D LOCALIZATION ?

ULP SMART
3D COCHLEA

Tous droits réservés

$$t_1 - t_2 = \frac{d_1 - d_2}{v}$$

$$\frac{x^2}{A_x^2} - \frac{y^2}{B_x^2} - \frac{z^2}{B_x^2} = 1$$

$$A_x = \frac{(d_1 - d_2)}{2}$$

$$B_x = \sqrt{D^2 - A_x^2}$$

Cochlée A 2 D Cochlée B

Hémisphère 1 :
A devance B

Hémisphère 2 :
B devance A

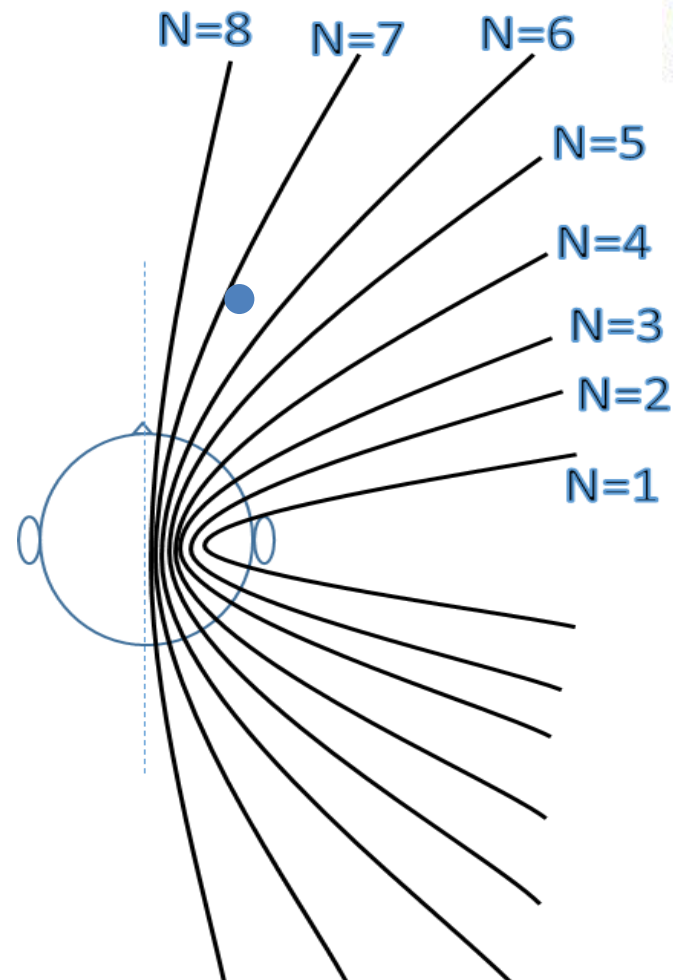
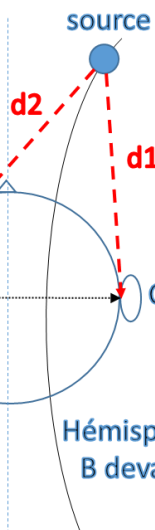

Conclusion

- ULP Artificial cochlea presented :
 - 100 nW / Channel (w/o buffer)
- Challenges :
 - Biodiversity monitoring (Ceteceans, not only)
 - Digital transition (Data deluge ↓)
- Key applications (biodiversity monitoring) :
 - Classification
 - Tracking
 - Anthropogenic noise impact ? (human activities)

Tous droits réservés