



**HAL**  
open science

## Ultra low power Cochlea for biodiversity monitoring

Francois Danneville, Larach Hicham, Pierre Boulet, Philippe Devienne, Hervé Glotin, Christophe Loyez

► **To cite this version:**

Francois Danneville, Larach Hicham, Pierre Boulet, Philippe Devienne, Hervé Glotin, et al.. Ultra low power Cochlea for biodiversity monitoring. Colloque BIOCAMP 2023, Nov 2023, Banyuls - sur - Mer, France. hal-04463709v1

**HAL Id: hal-04463709**

**<https://hal.science/hal-04463709v1>**

Submitted on 19 Mar 2024 (v1), last revised 20 Mar 2024 (v2)

**HAL** is a multi-disciplinary open access archive for the deposit and dissemination of scientific research documents, whether they are published or not. The documents may come from teaching and research institutions in France or abroad, or from public or private research centers.

L'archive ouverte pluridisciplinaire **HAL**, est destinée au dépôt et à la diffusion de documents scientifiques de niveau recherche, publiés ou non, émanant des établissements d'enseignement et de recherche français ou étrangers, des laboratoires publics ou privés.

Copyright

# Ultra low power Cochlea for biodiversity monitoring

François Danneville<sup>1</sup>

Hicham Leach<sup>1</sup>, Pierre Boulet<sup>2</sup>, Philippe Devienne<sup>2</sup>, Hervé Glotin<sup>3</sup>, Christophe Loyez<sup>1</sup>

Colloque Biocomp 2023, Banyuls sur Mer

1. *IRCICA, UAR CNRS 3380 et IEMN, UMR CNRS 8520, Villeneuve d'Ascq*
2. *CRISTAL, UMR CNRS 9189, Villeneuve d'Ascq*
3. *LIS, UMR CNRS 7020, Toulon*

# Biodiversity

## Biodiversity Loss

Main scientific and  
Societal challenge

Stimulate research in AI

Requirement of passive acoustic sensors:

- Detection, Classification, Localization
- Human / Nature acoustic Event
- 2 challenges:
  - Biodiversity Monitoring
  - Energetic frugality (carbon footprint as low as possible)

Tous droits réservés

# Biodiversity / Data Deluge

## □ Biodiversity :

- Between 1970 and 2018, 69% of wildlife\* population declined :
  - Terrestrial environment and/or Marine ecosystems
  - **26%** Marine and/or Terrestrial mammals and **14%** birds are threatened (\*\*)

## □ Data deluge :

- Digital data (processing / communication) grows exponentially
- ICT technologies represent 4% of carbon footprint worldwide (projection is **14%** \*\*\* en 2040)

\* Perrine Mouterde, *Le Monde*, 13 Octobre 2022

\*\* [https://www.ecologie.gouv.fr/biodiversite-presentation-et-informations-cles#scroll-nav\\_4](https://www.ecologie.gouv.fr/biodiversite-presentation-et-informations-cles#scroll-nav_4)

\*\*\* L. Belkhir et al, « Assessing global emission footprint : Trends to 2040 & recommendations”, *Journal of Cleaner Production*, 2018

Tous droits réservés



# Objective (i)

Development of a quasi-autonomous « embedded »  
electronic system (maintenance every 3 years)

## Artificial Cochlea :

- Analog information pre-processing
- Ultra frugal (power consumption)
- Mature CMOS Technology

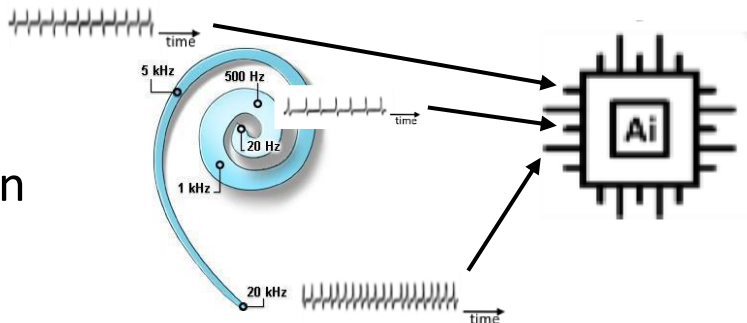

« local » information processing:

- Information Processing of « natural data » provided by the cochlea, **locally carried out** (« off the cloud »)

## Biodiversity Monitoring:

- Passive Bioacoustic Technology  
(**non-invasive**, respect wildlife)

# Objectives (ii)

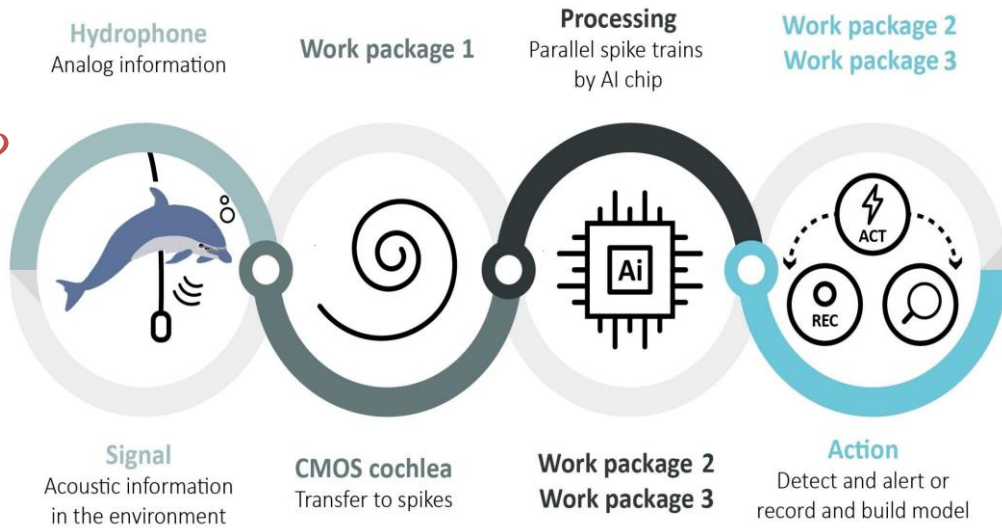

## ❑ Sensor characteristics:

- Classification/counting of ceteceans (unsupervised learning)
- Compact design
- Carbon footprint as low as possible
- Low cost

## Objectives (iii)



- ❑ Design of a monaural / binaural analog artificial Cochlea
  - *Ultra low power (< 30  $\mu$ Watt), 100 kHz Bandwidth*
  - *Coincidence Detector for sound localization*
- ❑ Design of AI chip to carry out biocomputing of « natural data » (generated by the Cochlea)
  - *Software Development based on Spiking Neural Networks trained for Ceteceans classification*
- ❑ Detection / Localization of specific acoustic events with main goal to preserve Ceteceans
  - *Add « alert » functionality to detect anthropogenic noise perturbing biodiversity*

Tous droits réservés

# Objectives (iv)



- ❑ Design of a monaural / binaural analog artificial Cochlea
  - *Ultra low power (< 30  $\mu$ Watt), 100 kHz Bandwidth*
  - *Coincidence Detector for sound localization*
- ❑ Design of AI chip to carry out biocomputing of « natural data » (generated by the Cochlea)
  - *Software Development based on Spiking Neural Networks trained for Ceteceans classification*
- ❑ Detection / Localization of specific acoustic events with main goal to preserve Ceteceans
  - *Add « alert » functionality to detect anthropogenic noise perturbing biodiversity*

Tous droits réservés

# Biological Cochlea

ULP SMART  
3D COCHLEA

G. V. Kékényi ~ 1960\*

Amplitude des déplacements de la membrane basilaire en fonction de la fréquence.

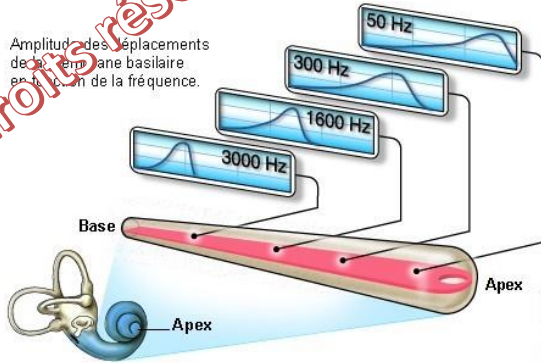

Passive  
Tonotopy

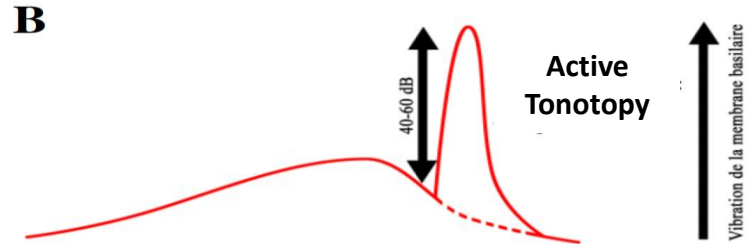
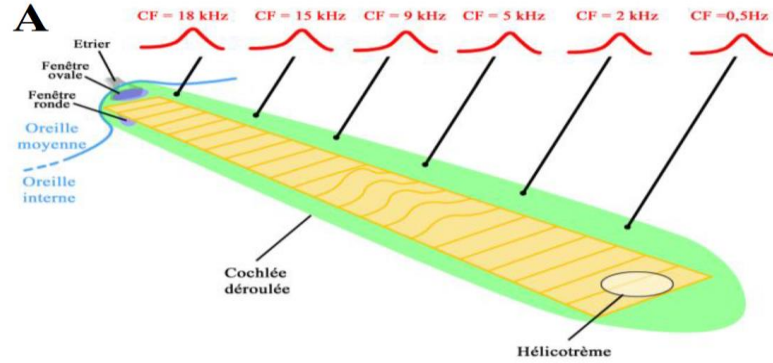

\* <https://www.cochlea.eu/cochlee/fonctionnement>

# Artificial Cochlea : the Pioneers (i)

IEEE TRANSACTIONS ON ACOUSTICS, SPEECH, AND SIGNAL PROCESSING, VOL. 36, NO. 7, JULY 1988

## An Analog Electronic Cochlea

RICHARD F. LYON, MEMBER, IEEE, AND CARVER MEAD

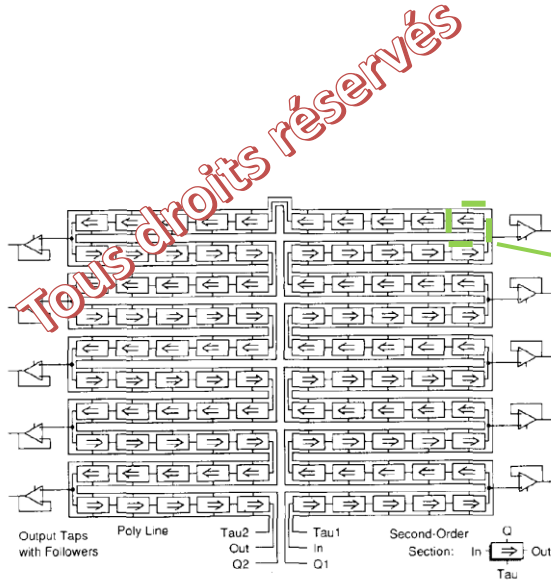

Tous droits réservés

Basic Unit :  
2<sup>nd</sup> order Filter

$$H(s) = \frac{1}{\tau^2 s^2 + \frac{1}{Q} \tau s + 1}$$

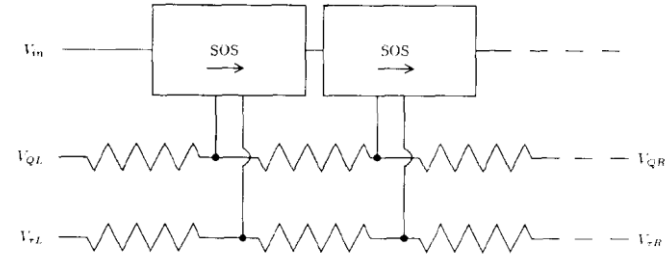

Fig. 3. Silicon cochlea, consisting of a serial cascade of second-order sections and tilted bias lines.

Fig. 8. Floorplan of 100-stage cochlea chip, in serpentine arrangement. The wires that are shown connecting the TAU and Q control terminals of the filter stages are built using a resistive polysilicon line, to act as a voltage divider that adjusts the bias currents in the cascade as an exponential function of distance from the input.

## An Analog Electronic Cochlea

RICHARD F. LYON, MEMBER, IEEE, AND CARVER MEAD

Tous droits réservés

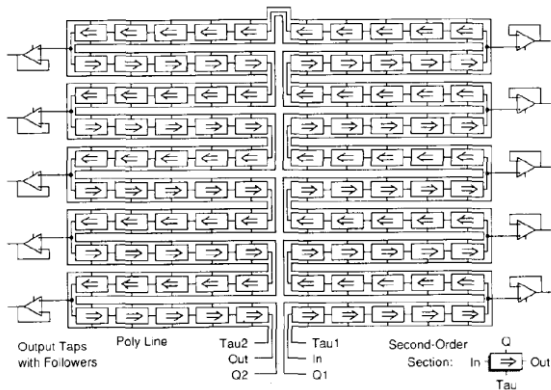
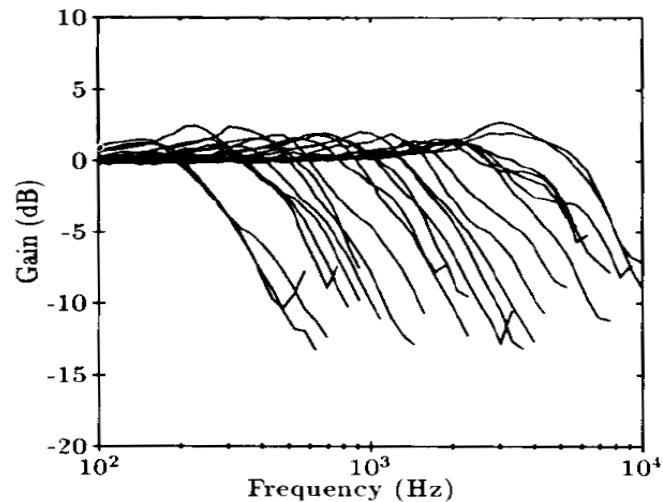

Fig. 8. Floorplan of 100-stage cochlea chip, in serpentine arrangement. The wires that are shown connecting the TAU and Q control terminals of the filter stages are built using a resistive polysilicon line, to act as a voltage divider that adjusts the bias currents in the cascade as an exponential function of distance from the input.



# Artificial Cochlea

## From acoustic signal sensing to spike encoding

Tous droits réservés

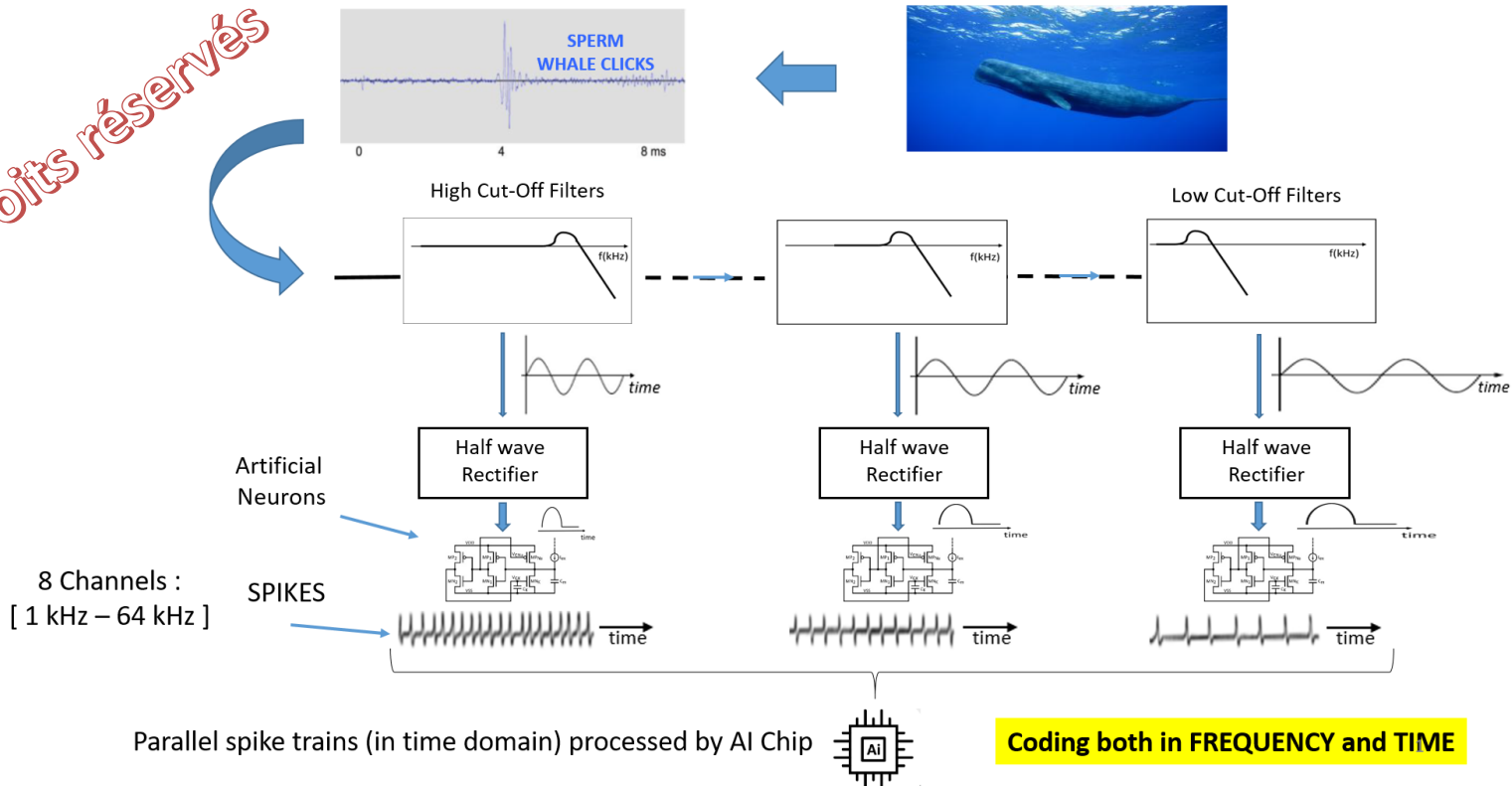



# Artificial Cochlea

## Cascade of Filters

Tous droits réservés

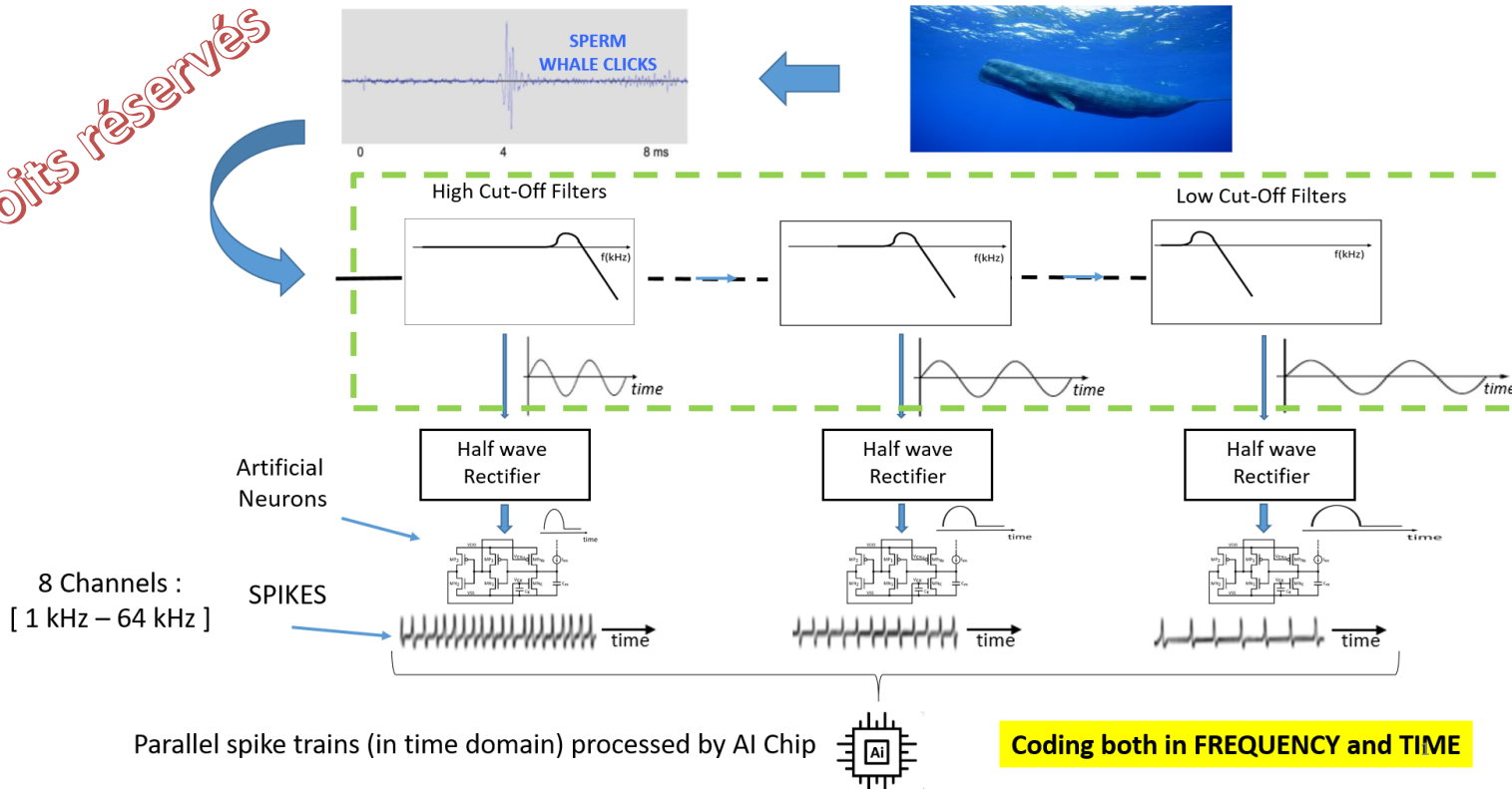

Parallel spike trains (in time domain) processed by AI Chip

# Artificial Cochlea

## Cascade of Filters

Tous droits réservés

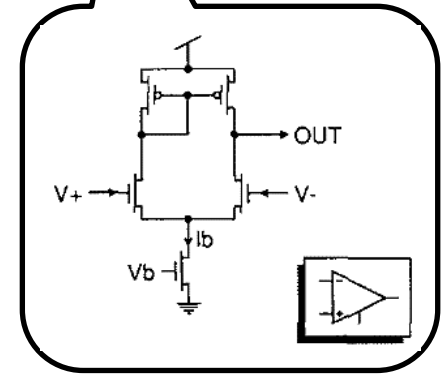
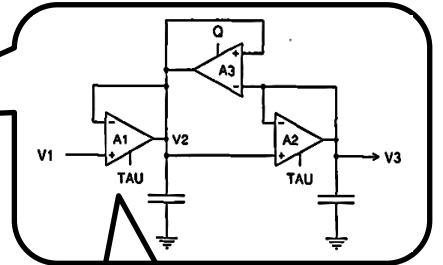
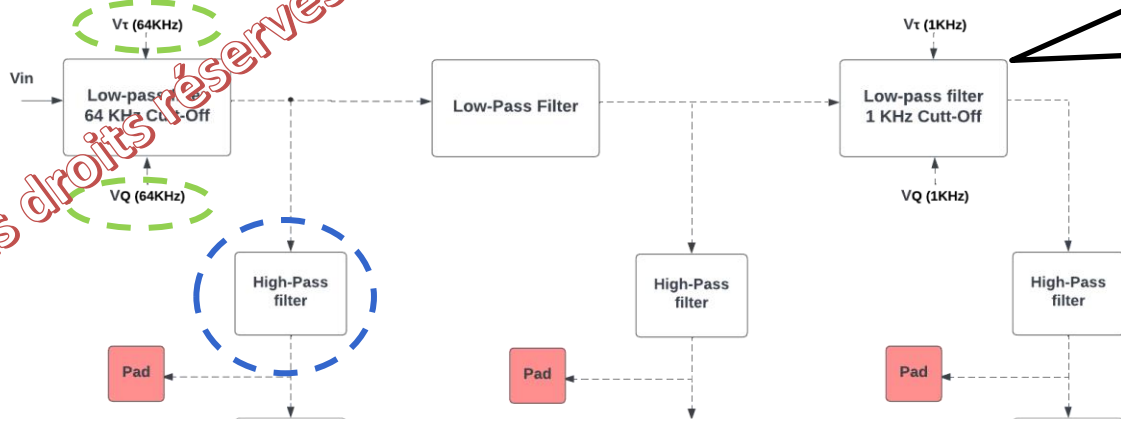

# Artificial Cochlea

## Conversion to spikes ?



Tous droits réservés

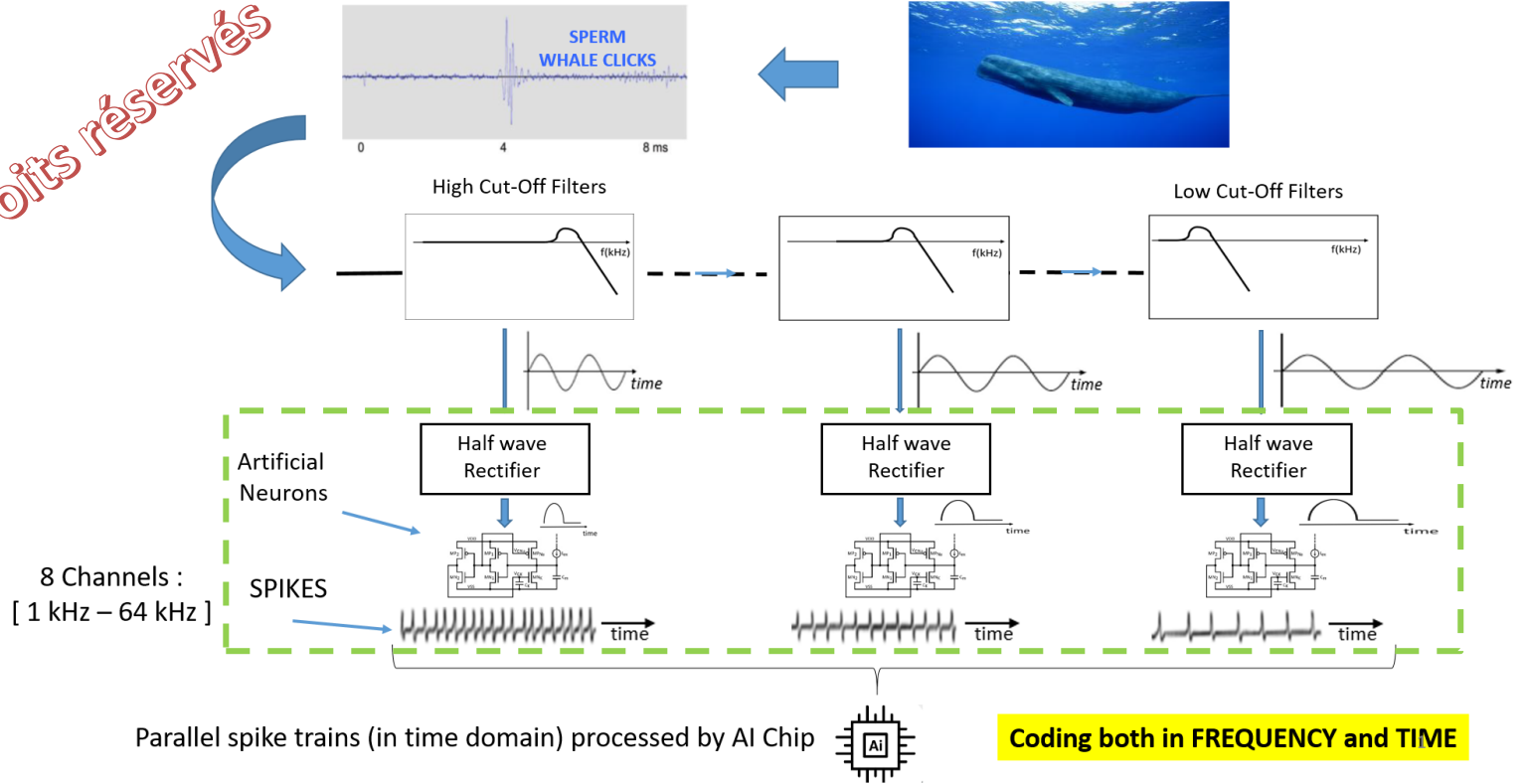

Parallel spike trains (in time domain) processed by AI Chip



Coding both in FREQUENCY and TIME

# Artificial Cochlea

## Artificial Neuron\*

Silicon transistor circuit

Tous droits réservés

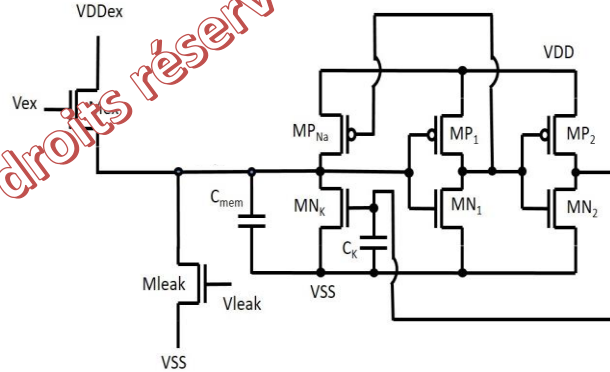

Vmem

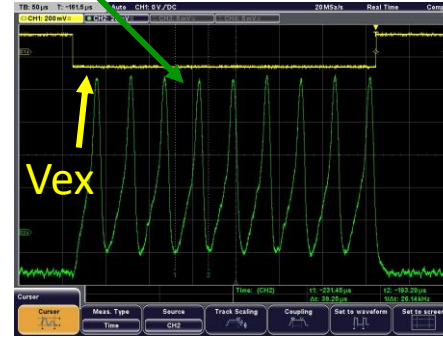

~ 100 mV  
(as in biology)

time

Power Consumption < 100 pW

\* Patent, FR3050050 A1, 13/10/2017 (INPI)

# Artificial Cochlea

## Half Wave Rectifier ?

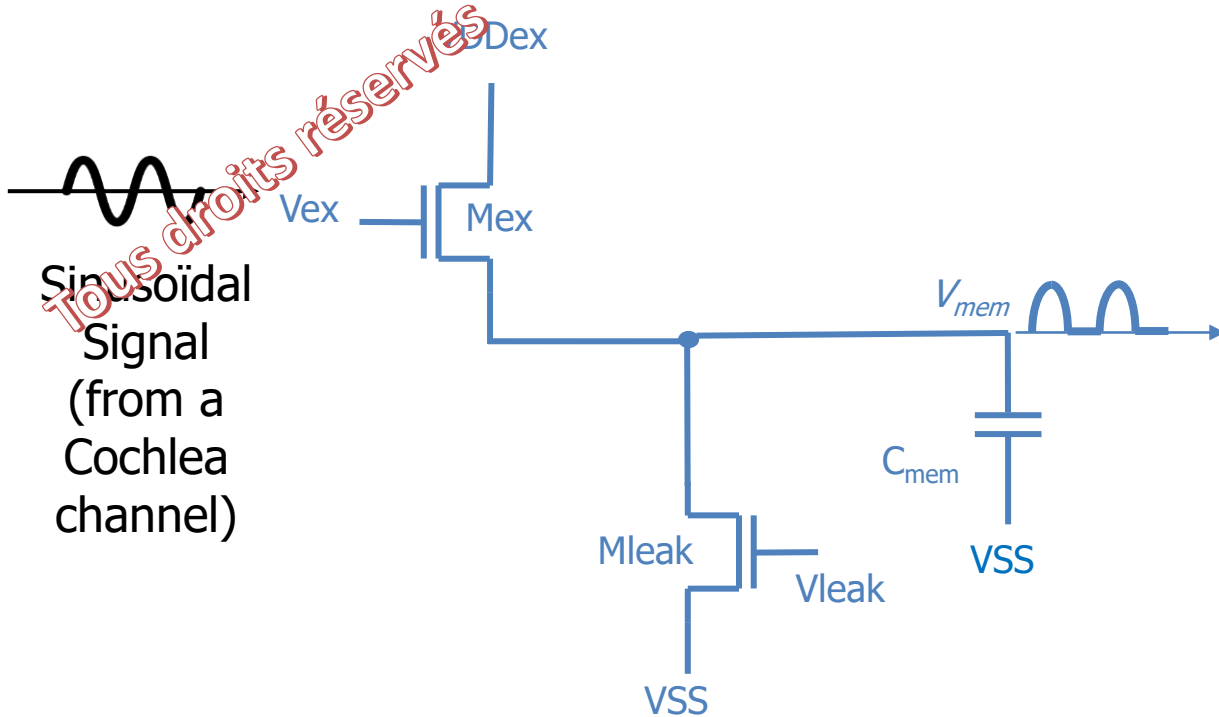

$V_{mem}$  turns to be a half wave signal

# Artificial Cochlea

## Conversion to spikes ?

Tous droits réservés

Sinusoidal  
Signal  
(from a  
Cochlea  
channel)

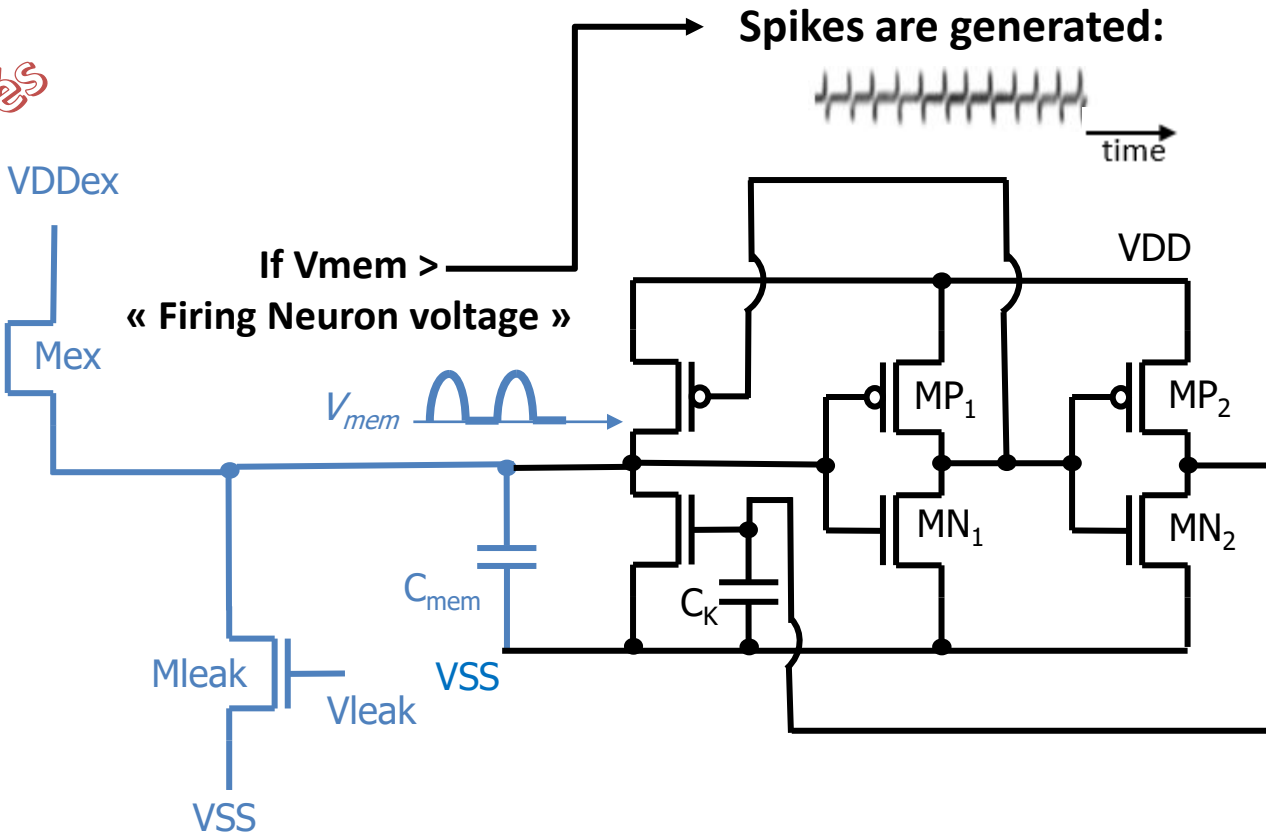

# Implementation in CMOS TSMC 65nm Technology

ULP SMART

Layout (Cadence)

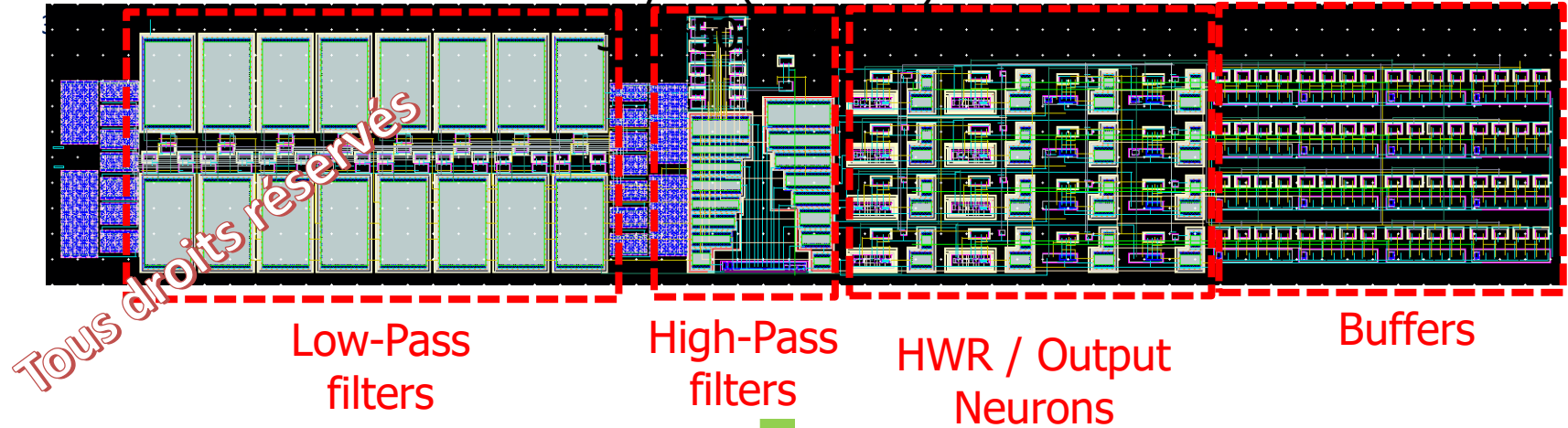

CMOS Microchip  $1500 \times 250 \mu\text{m}^2$



8 Output Channels

Tous droits réservés

# Simulated results



# Artificial Cochlea

## Cascade of Filters:

Frequency Channels (kHz) : 0.5-1-2-4-8-16-32-64

Tous droits réservés

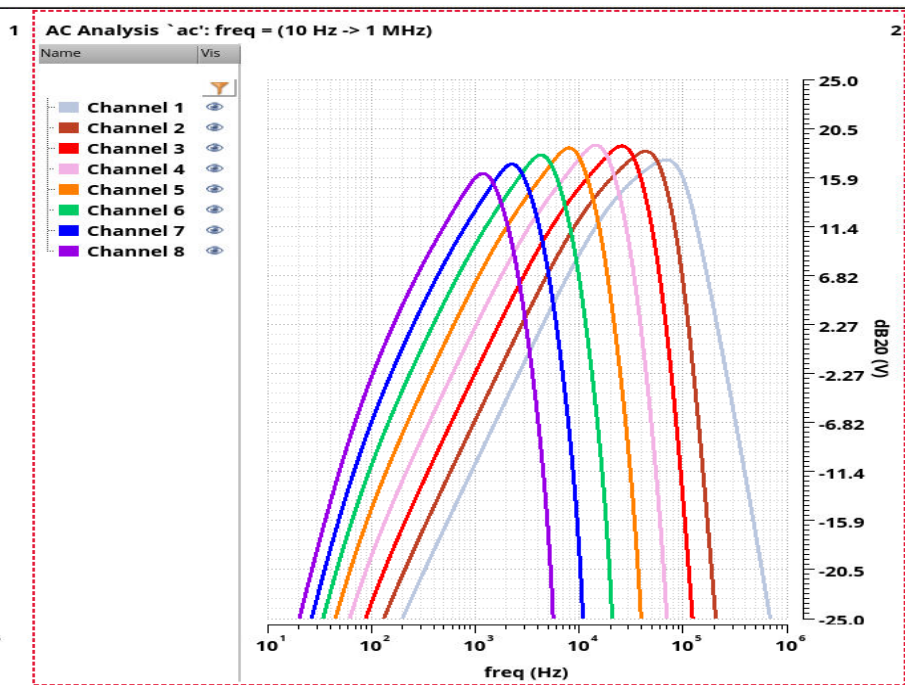
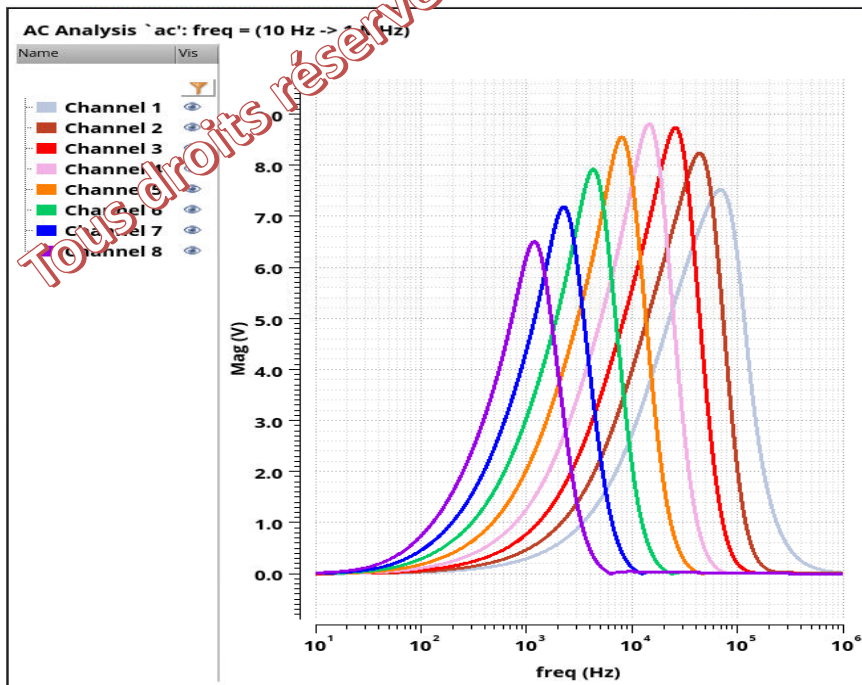

# Artificial Cochlea

## Conversion to spikes

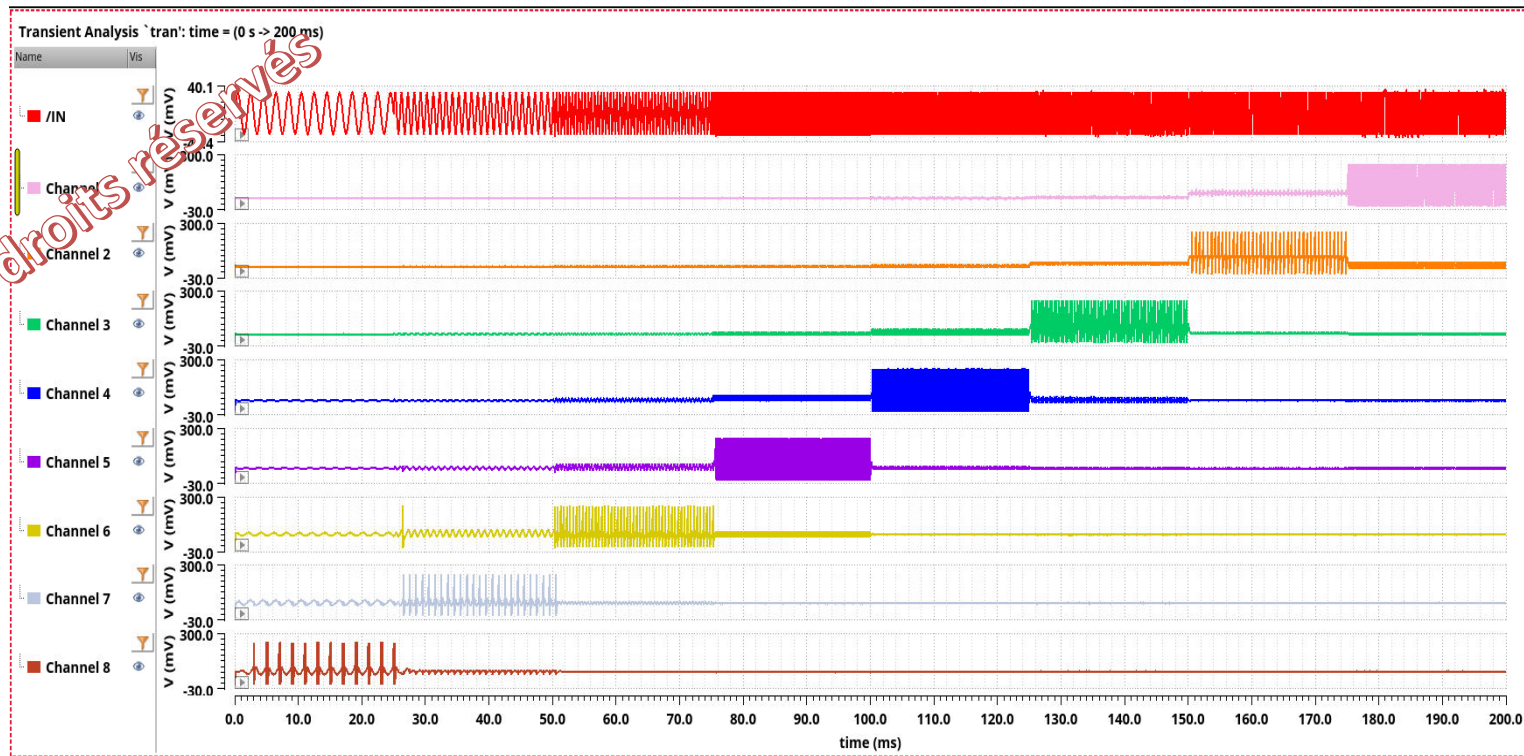

# Artificial Cochlea: Simulation / Experimental results

Tous droits réservés

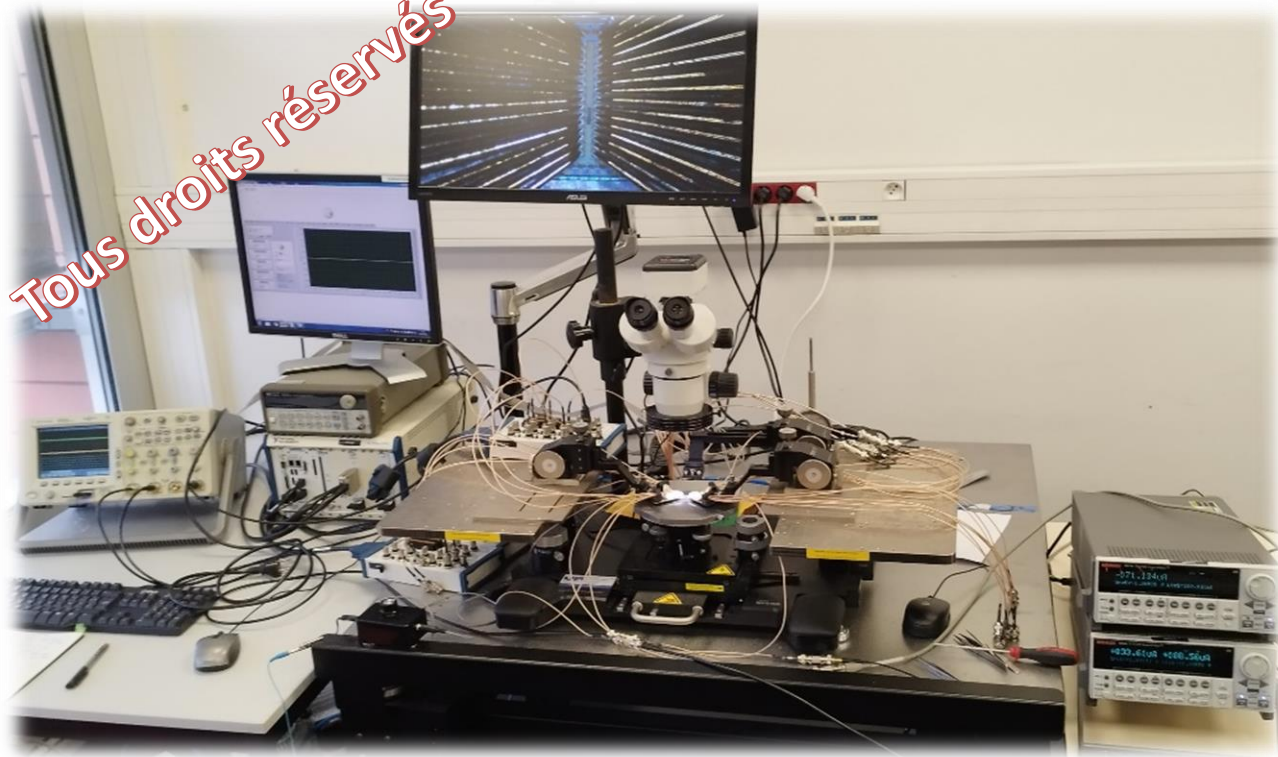

Characterization :  
Use of a probe station

# Acoustic (natural) Signal of two Cetaceans

ULP SMART  
3D COCHLEA



Sperm Whale clicks : Discovery of Sound in the Sea

<https://dosits.org/galleries/audio-gallery/marine-mammals/toothed-whales/sperm-whale>



Rough-toothed Dolphin clicks : DCLDE Oahu

<https://www.soest.hawaii.edu/ore/dclde/>

Tous droits réservés



# Acoustic (natural) Signal of two Ceteceans

UL SMART  
3D

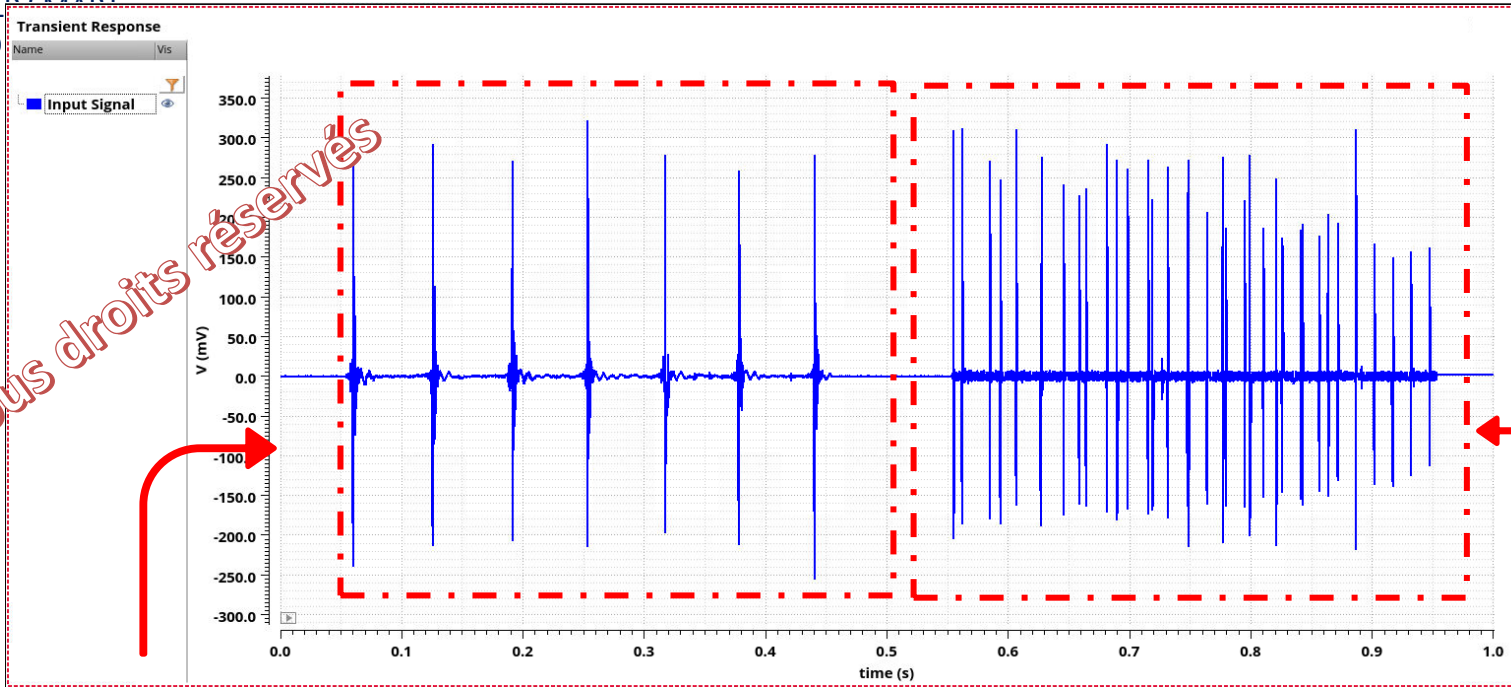

Tous droits réservés

Sperm Whale  
(*Physeter macrocephalus*)



© Martin Prochazkacz / shutterstock



The rough-toothed  
dolphin  
(*Steno bredanensis*)

# Sperm Whale clicks

ULP SMART  
3D COCHLEA

Tous droits réservés

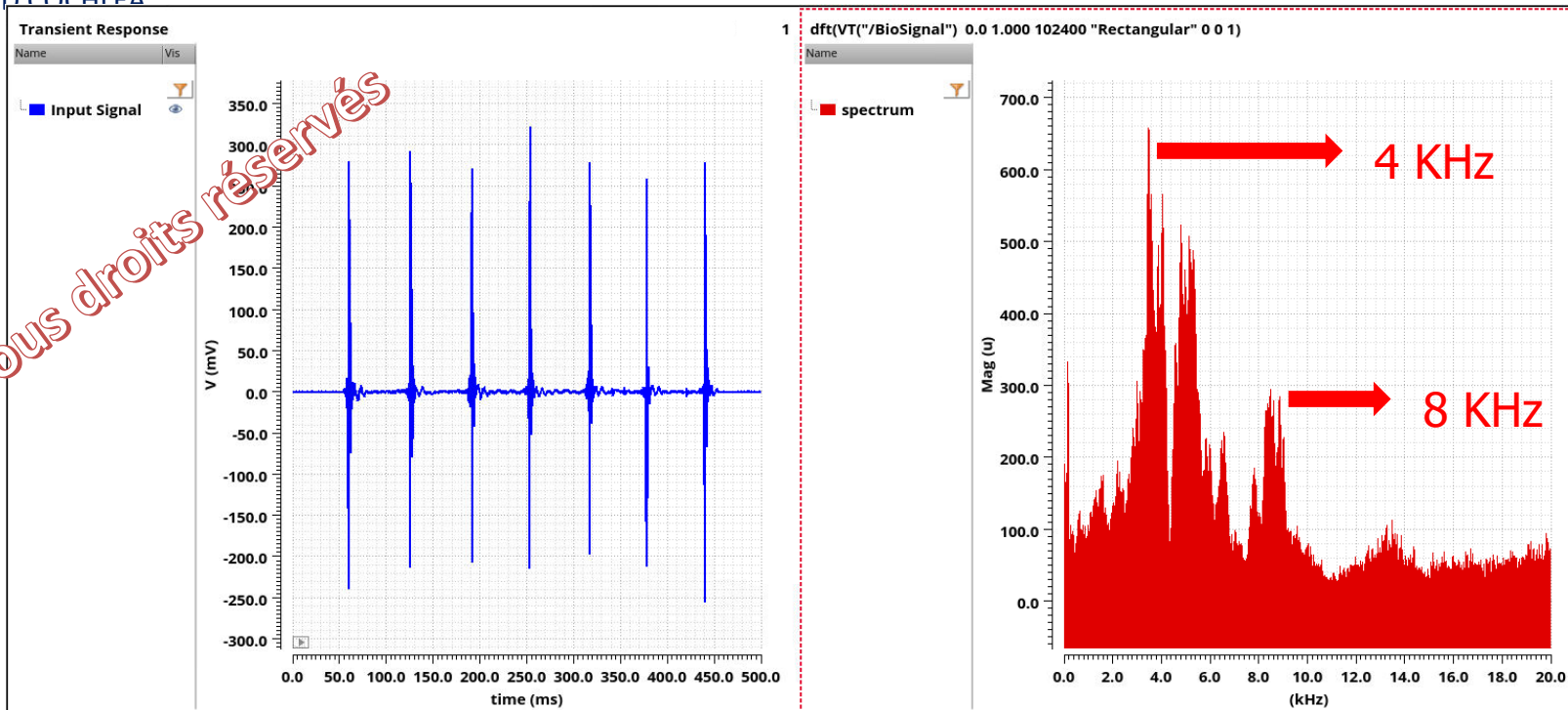

Sperm whale clicks : spectrum

# Response of the Cochlea to Sperm Whale Clicks (simulation in CADENCE)

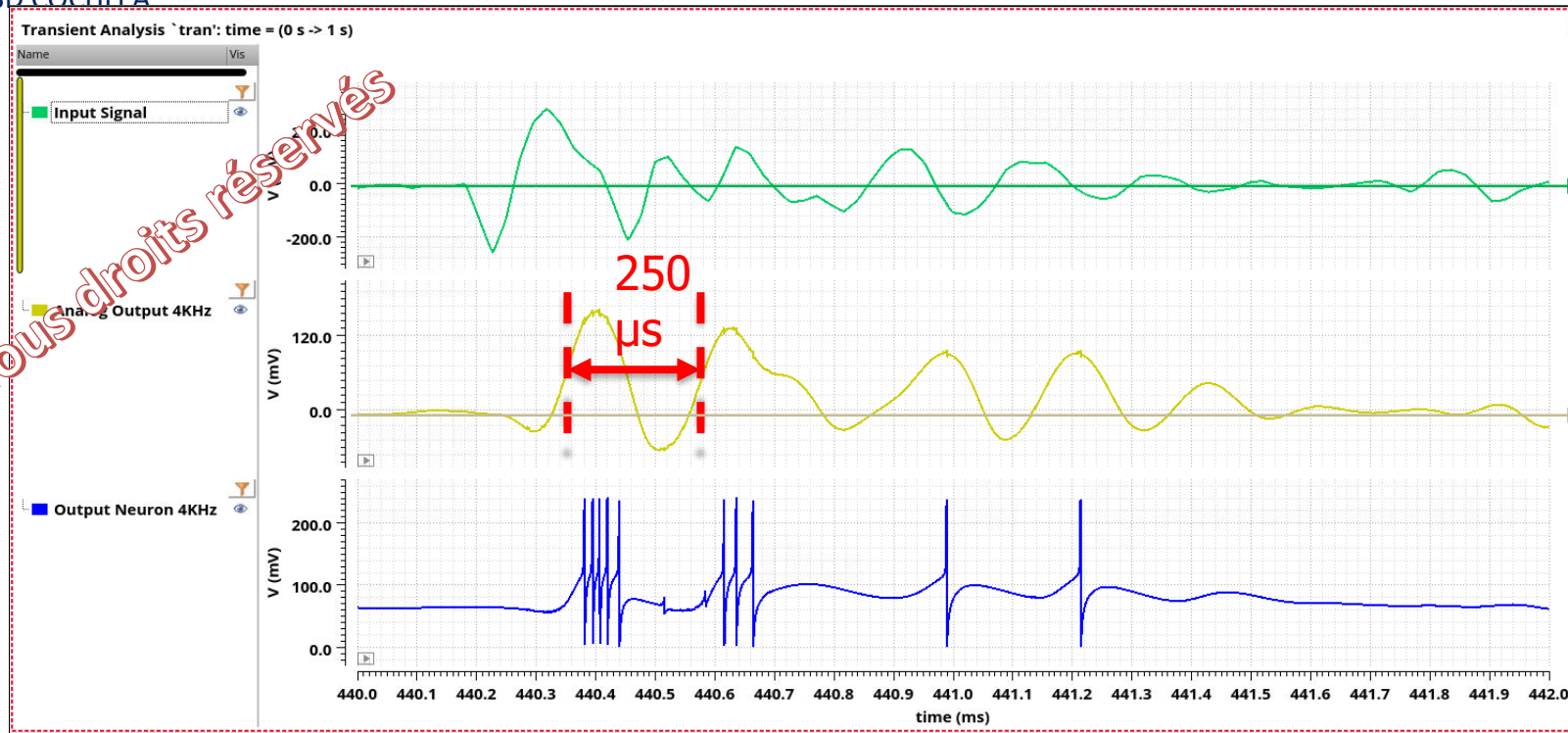
ULP SMART  
3D COCHLEA

Transient response of the cochlea to a single Sperm Whale click ( 4KHz Channel )

# Response of the Cochlea to Sperm Whale Clicks (simulation in CADENCE)

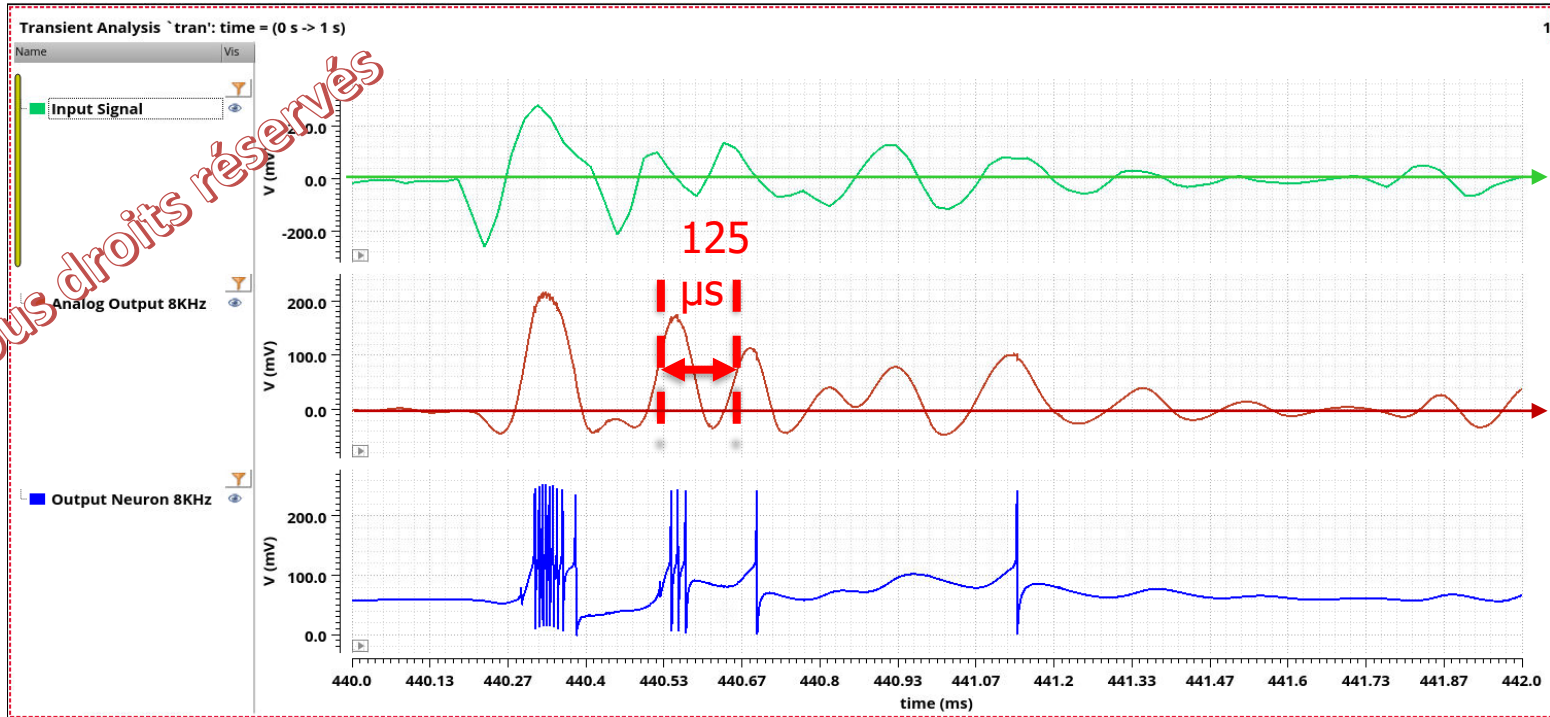

Transient response of the cochlea to a single Sperm Whale click ( 8KHz Channel )

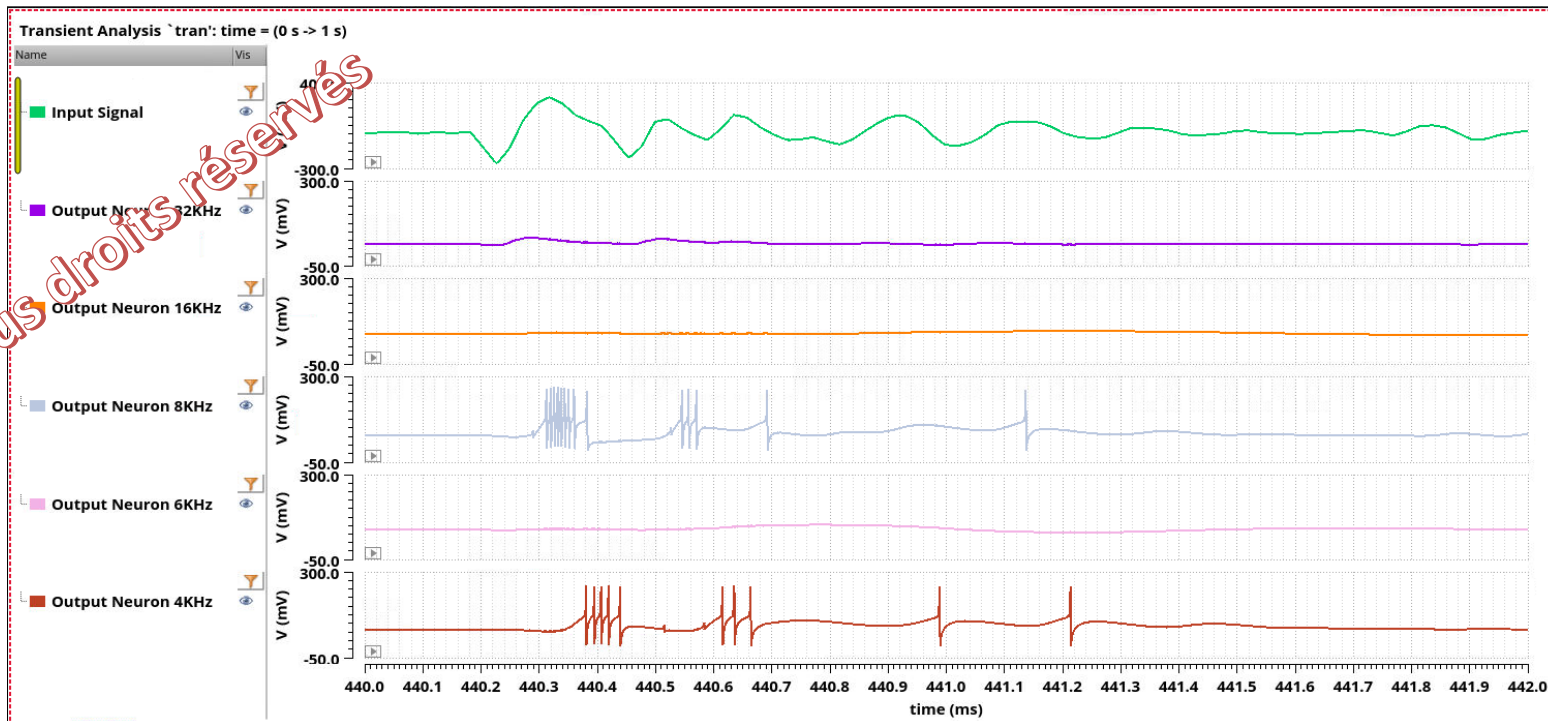

# Response of the Cochlea to Sperm Whale Clicks (simulation in CADENCE)

ULP SMART  
3D COCHLEA

Transient response of the cochlea to a single Sperm Whale click ( All Channels )

# Response of the Cochlea to Sperm Whale Clicks (simulation in CADENCE)

ULP SMART  
3D COCHLEA

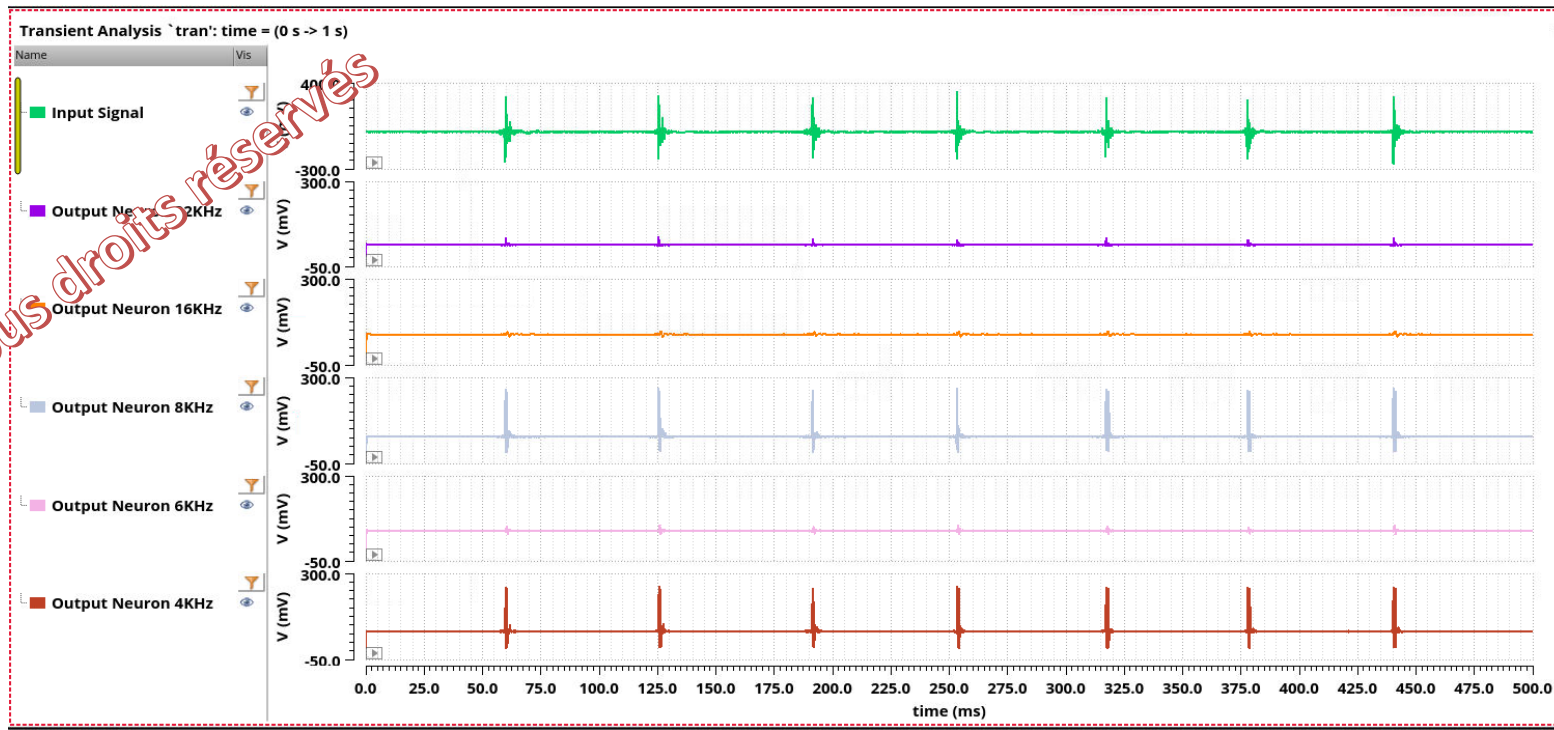

Transient response of the cochlea to a train of Sperm Whale clicks ( All Channels )

# Response of the Cochlea to Sperm Whale Clicks (Experimental results)

ULP SMART  
3D COCHLEA

Agilent Technologies

TUE OCT 24 17:13:08 2023

Tous droits réservés

250µs

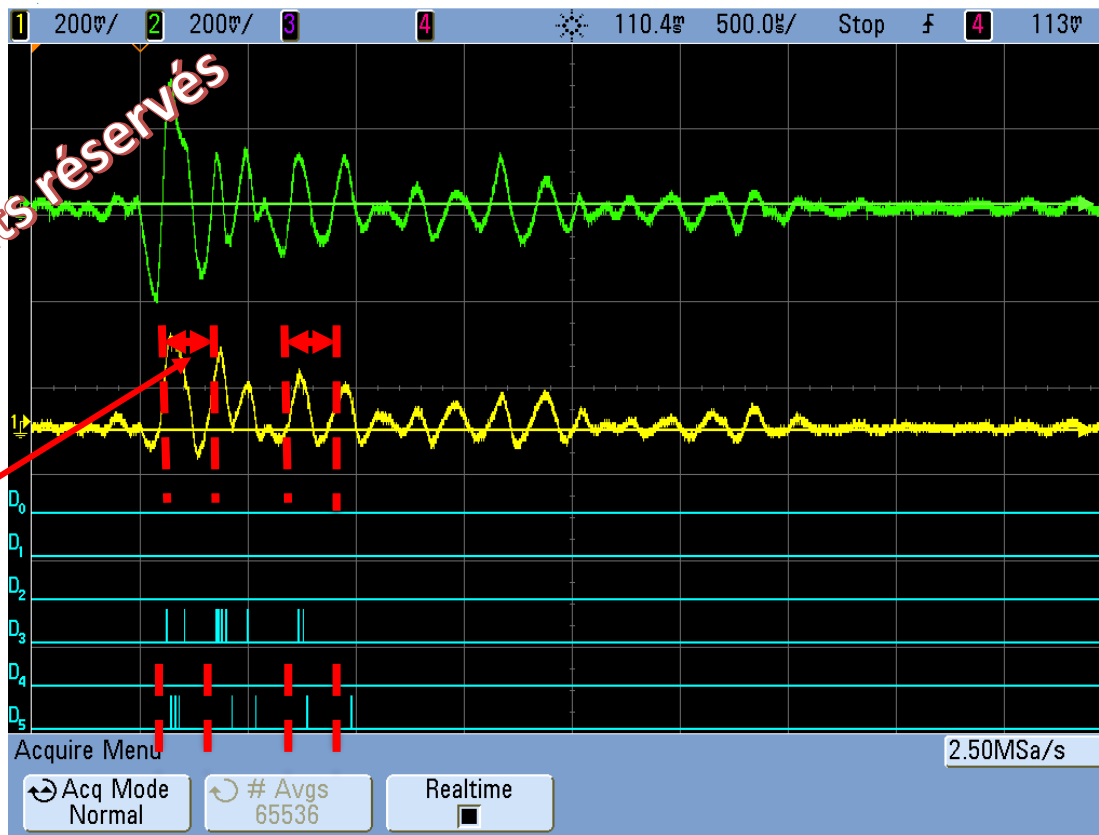

← Sperm Whale click

Single output of Filters bank available

← Analog output 4KHz

← 32KHz Channel

← 8KHz Channel

← 4KHz Channel

# Response of the Cochlea to Sperm Whale Clicks (Experimental results)

Tous droits réservés

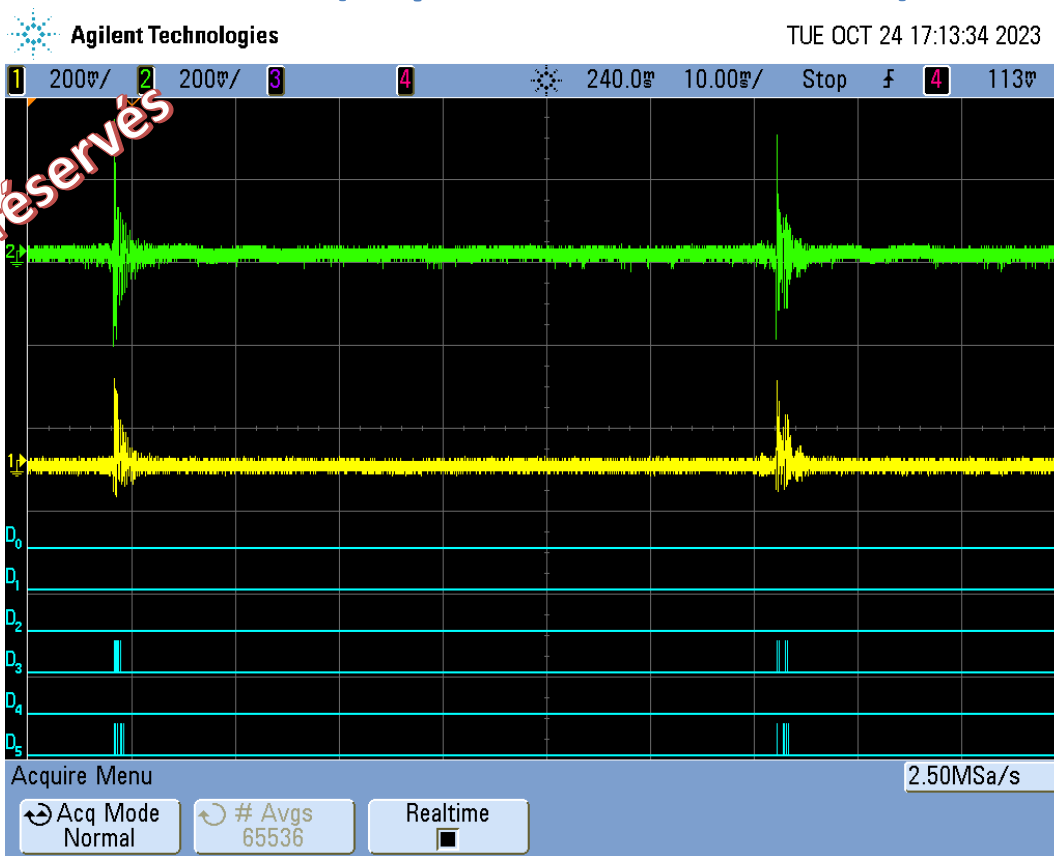

- ← Sperm Whale click
- ← Analog output 4KHz
- ← 32KHz Channel
- ← 8KHz Channel
- ← 4KHz Channel

# Dolphin clicks

ULP SMART  
3D COCHLEA

Tous droits réservés

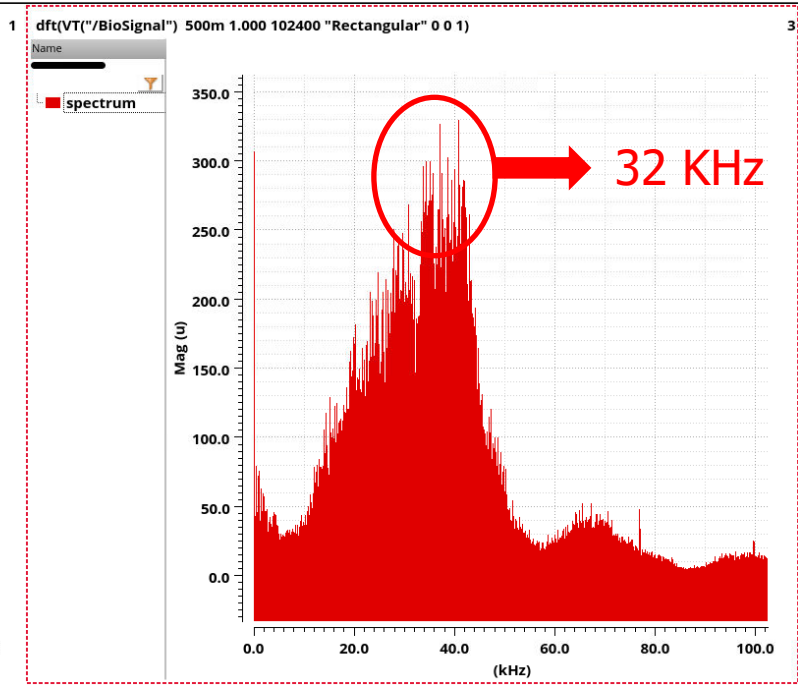
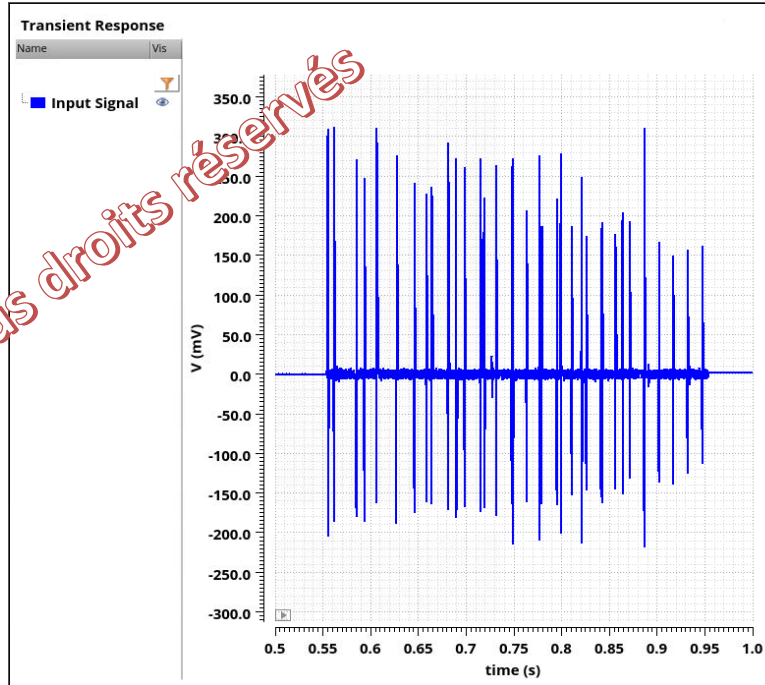

Dolphin clicks: spectrum

# Response of the Cochlea to Dolphin Clicks (simulation in CADENCE)

ULP SMART  
3D COCHLEA

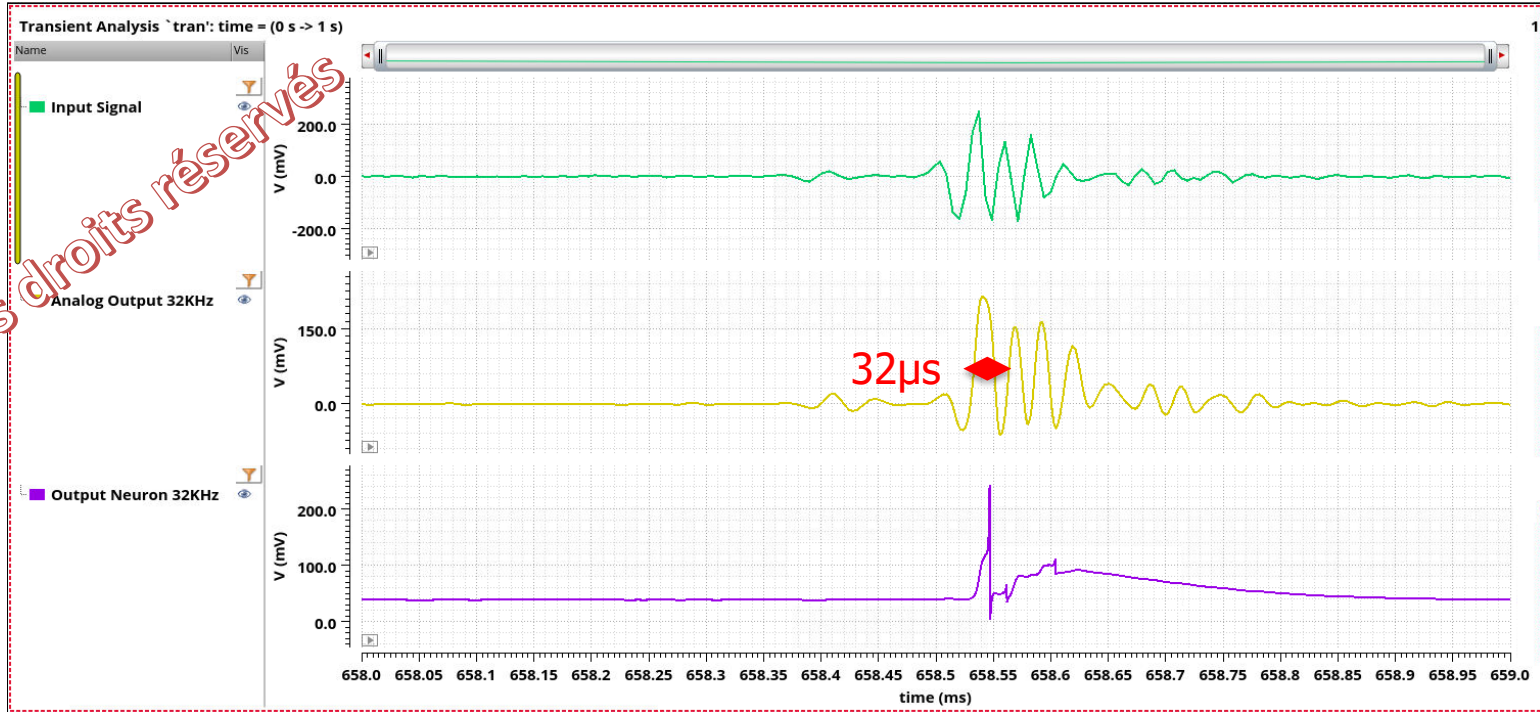

Transient response of the cochlea to a single Dolphin click ( 32KHz Channel )

# Response of the Cochlea to Dolphin Clicks (simulation in CADENCE)

ULP SMART  
3D COCHLEA

Tous droits réservés

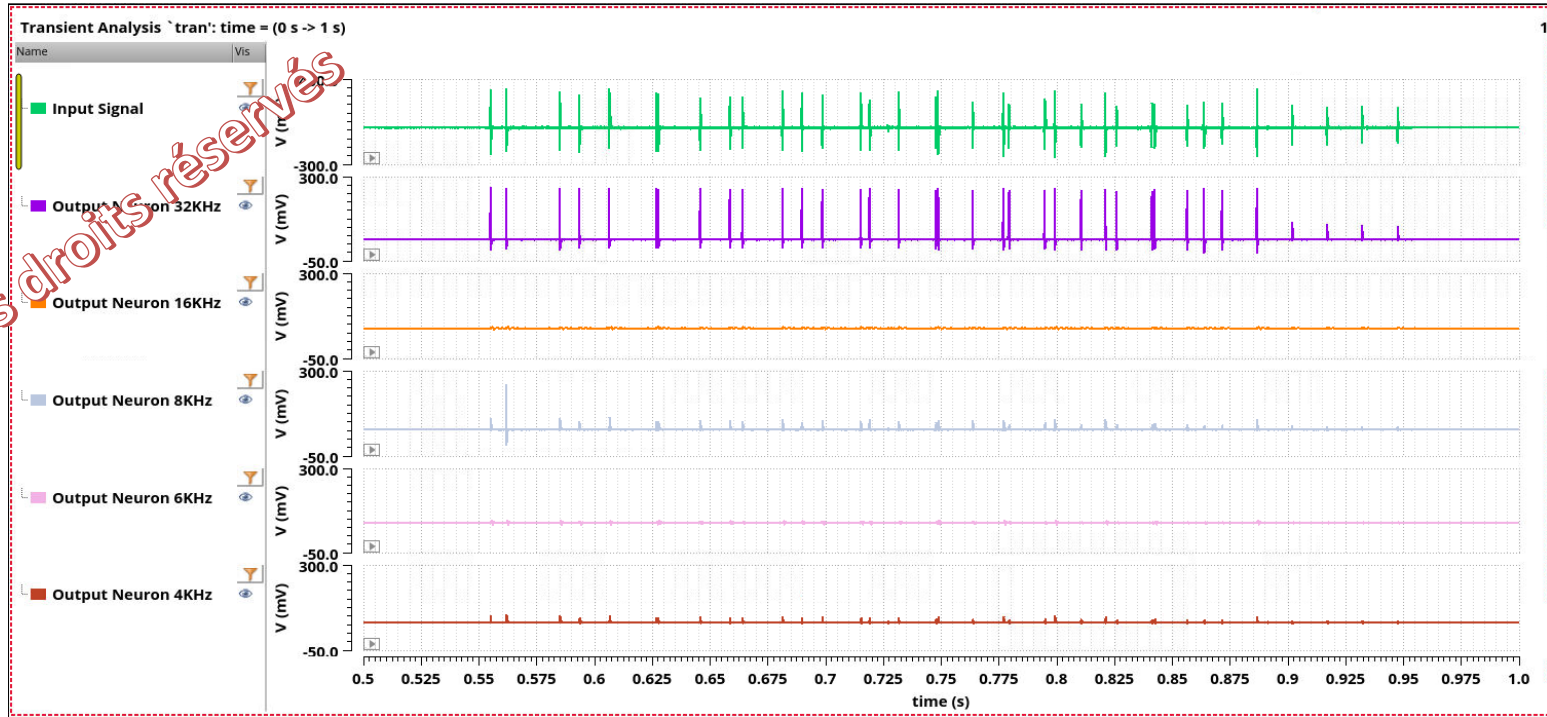

Transient response of the cochlea to a train of Dolphin clicks ( ALL KHz Channel )



# Response of the Cochlea to Dolphin Clicks (Experimental results)

Tous droits réservés

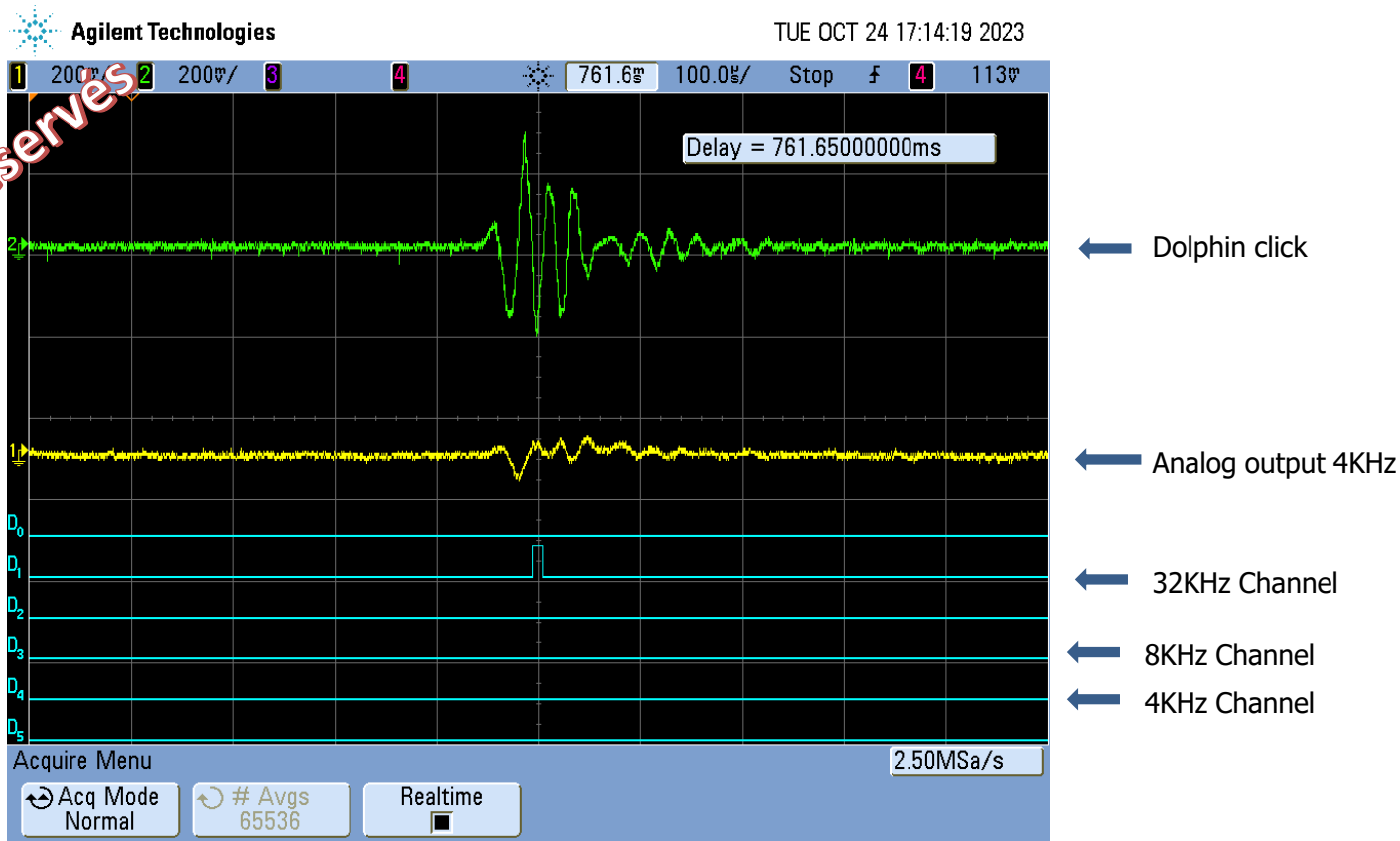



# Response of the Cochlea to Dolphin and Sperm Whale clicks (simulation in CADENCE)

Tous droits réservés

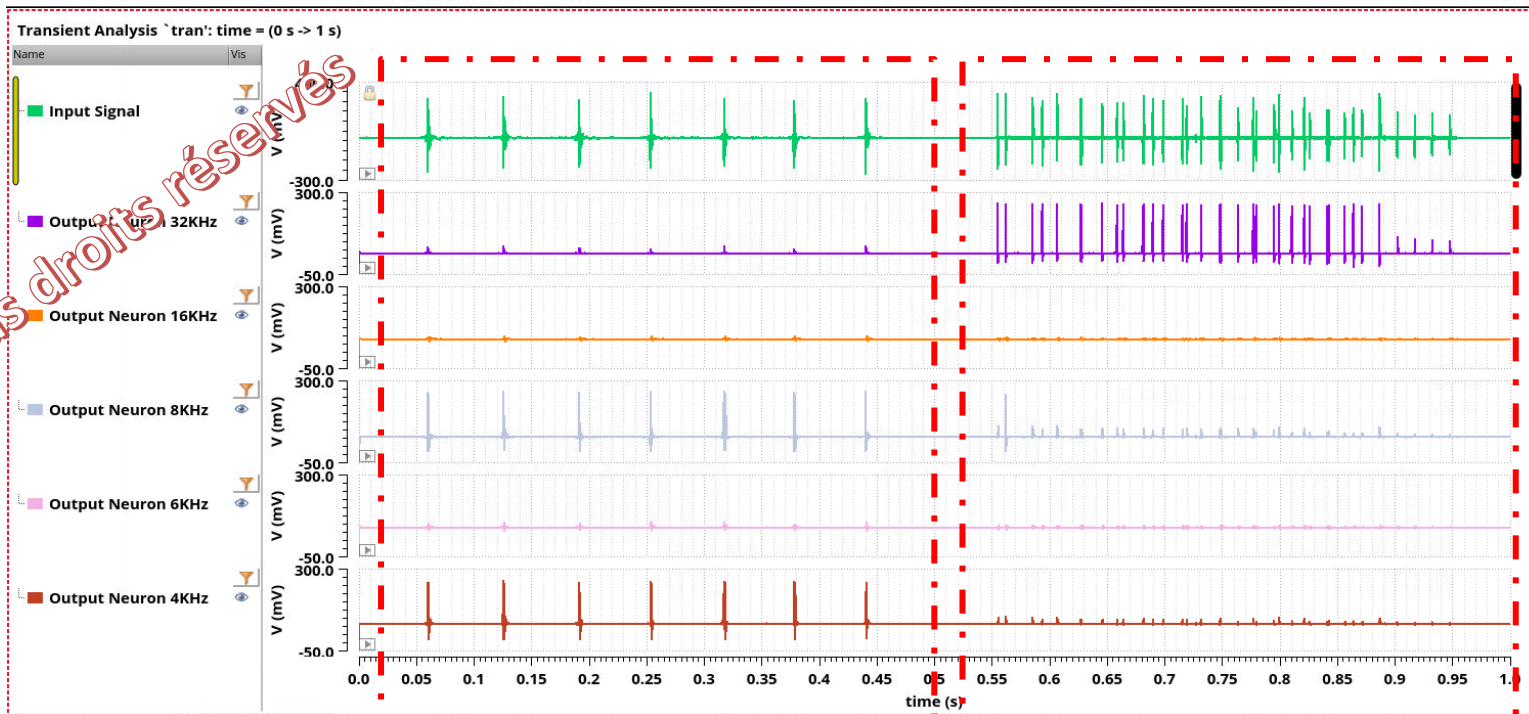

Sperm  
Whale

Dolphin

# Response of the Cochlea to Dolphin and Sperm Whale Clicks (Experimental results)

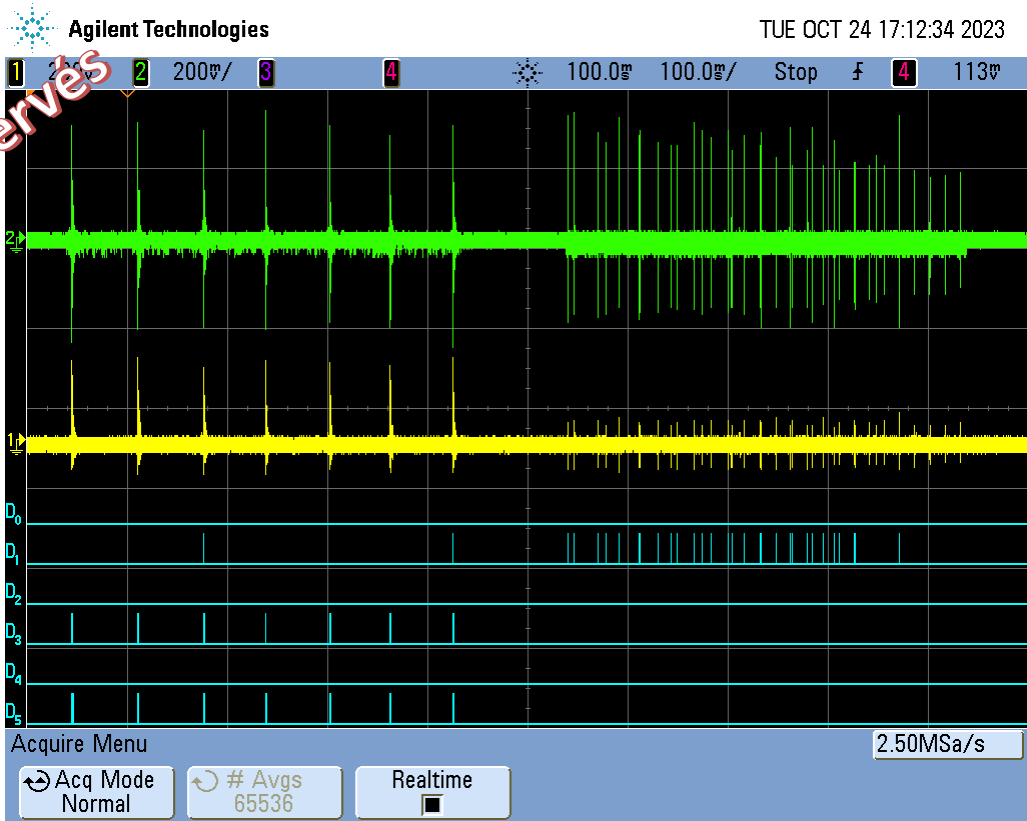

Tous droits réservés

## Power consumption ?

CMOS Microchip  $1500 \times 250 \mu\text{m}^2$



Tous droits réservés

8 Channels

With buffers (required for characterization) :  
~ few microWatts / channel

Without buffers (required for characterization) :  
100 nanoWatts / channel

Tous droits réservés

ANR ULP SMART COCHLEA



NEXT ?

# Dataset

Tous droits réservés



NEW BEDFORD WHALING MUSEUM

Woods Hole Oceanographic Institution

## Watkins Marine Mammal Sound Database

'BEST OF' CUTS ALL CUTS MASTER TAPES ABOUT

The William A. Watkins Collection of Marine Mammal Sound Recordings consists of recordings of various marine mammal species collected over a span of seven decades in a wide range of geographic areas by Watkins and many others. [\[MORE\]](#)

# Dataset

10 species selected from the dataset

*Tous droits réservés*

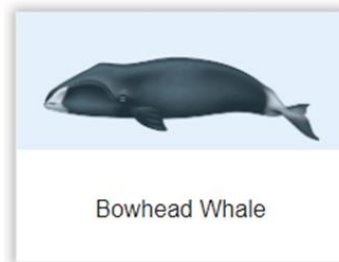

**Binary Classification** : Two classes are used the first class contains several species of marine mammals and the second class corresponds to the killer whale species.

Tous droits réservés

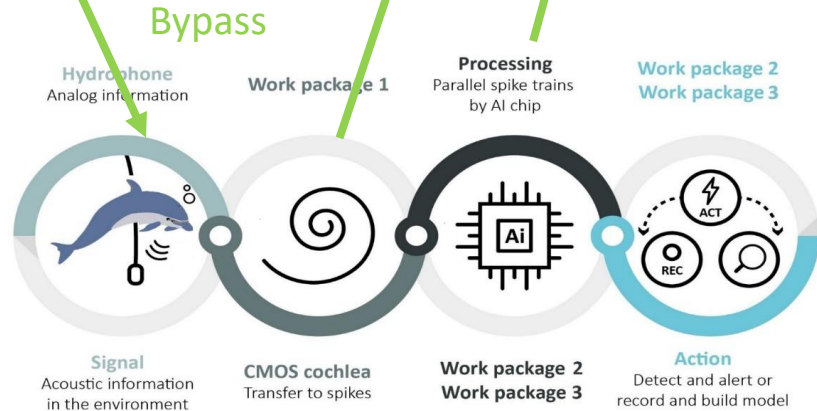
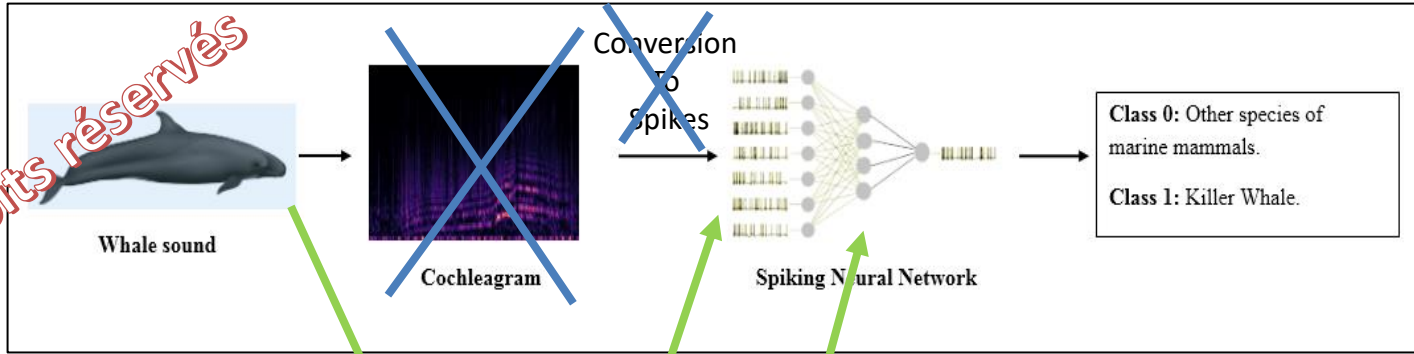

Tous droits réservés

ANR ULP SMART COCHLEA



LOCALIZATION ?



Hi!, where are you located ?



*3D localisation of sperm whales (in the abyss) possible,  
using specific algorithms*

Tous droits réservés

(meters)

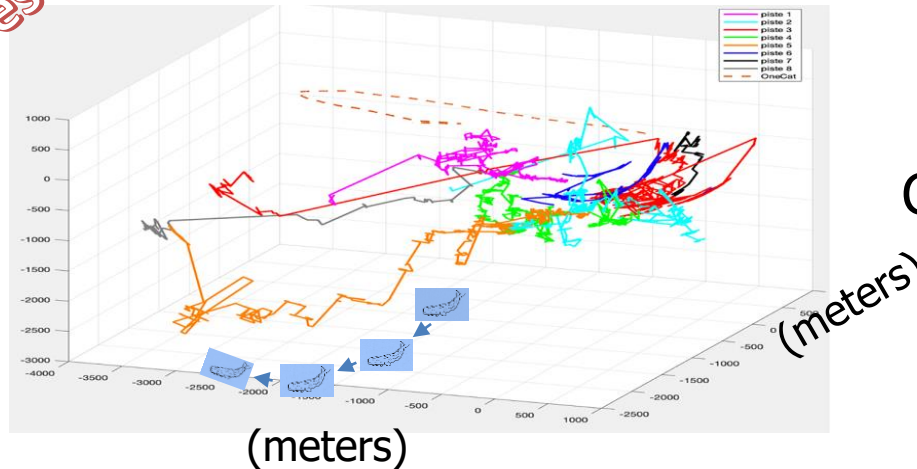

Courtesy: Prof. H. Glotin  
Univ. Toulon

*Sphyrna Odyssey 2019-2020 : 3D tracks of 7 sperm whales off Monaco coast,  
during 2 hours, hunting in collaboration in the abyss (-1000 à -2000m)*

<https://www.franceinter.fr/emissions/la-terre-au-carre/la-terre-au-carre-29-octobre-2020>

# Sound Localization : basics

Tous droits réservés

Left Ear

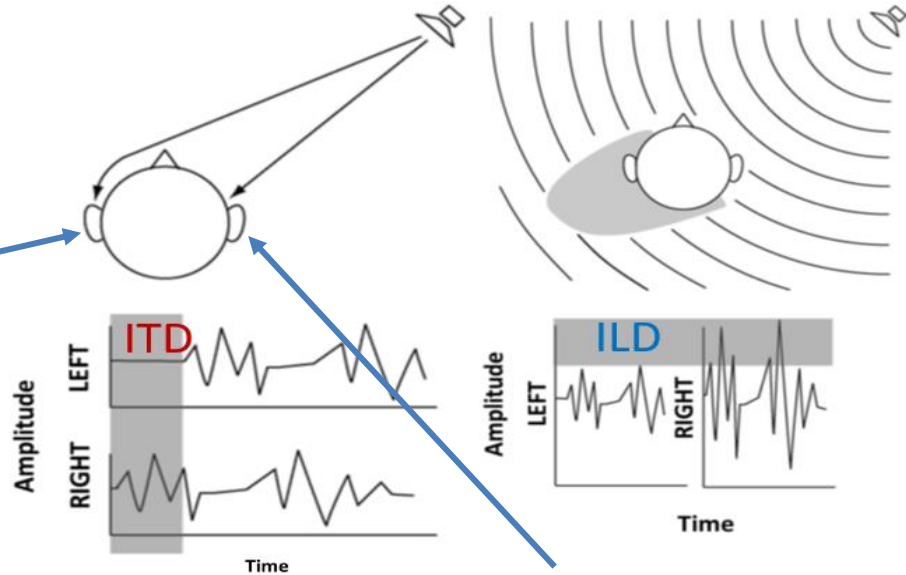

Right Ear

ITD : Interaural Time Difference

ILD : Interaural Level Difference

# Sound Localization : how ITD is encoded in biology\* ?

## Jeffers model

Tous droits réservés

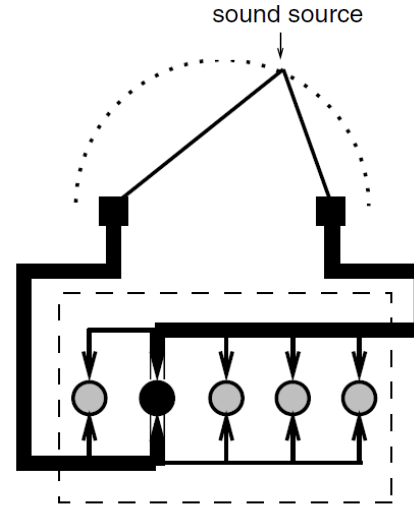
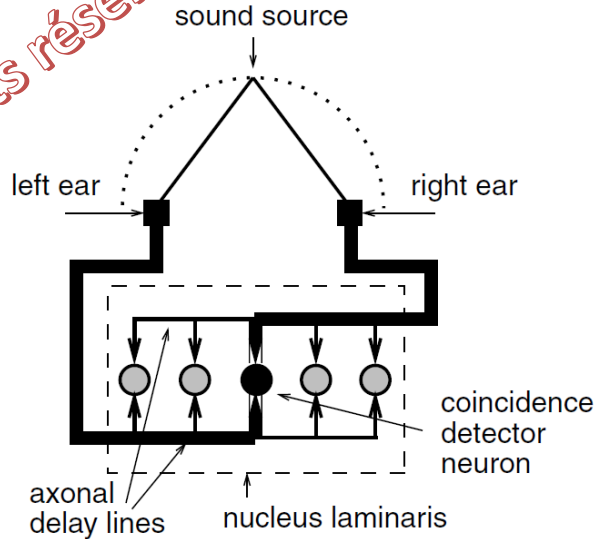

\* J. Leo van Hemmen et al, *Problems in Neuroscience*, Oxford University Press, USA, 2006

# MOTION DETECTOR :

## « Hassenstein-Reichardt » detector (1956)



Tous droits réservés

Luminous spot that moves



Luminous spot that moves

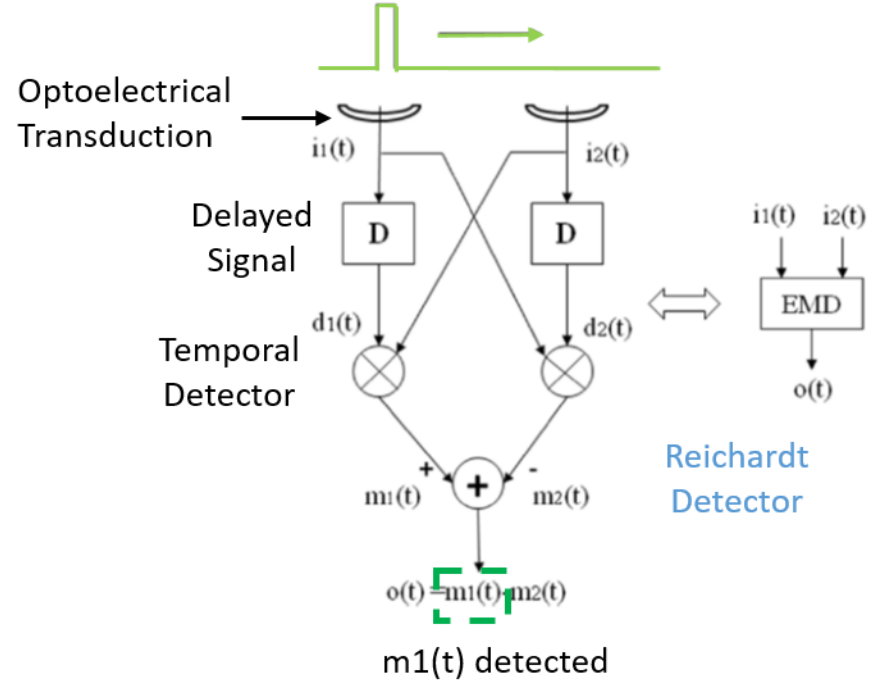

# Coincidence Detector\*:

coding interaural time difference (ITD),  
by (simply) counting spikes

Tous droits réservés

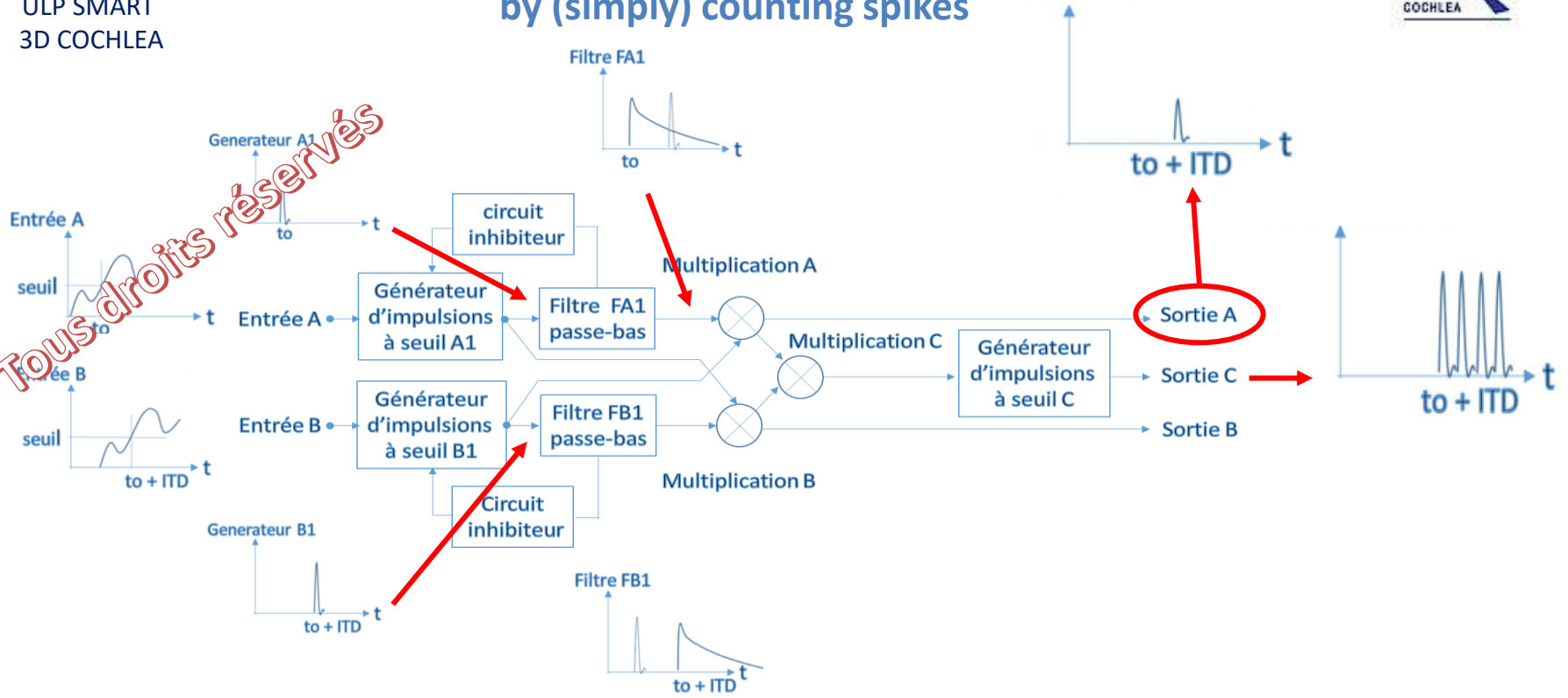

\* Patent, FR2112849, 02/12/2021 (INPI)

# 2D LOCALIZATION ?

ULP SMART  
3D COCHLEA

Tous droits réservés

$$t_1 - t_2 = \frac{d_1 - d_2}{v}$$

$$\frac{x^2}{A_x^2} - \frac{y^2}{B_x^2} - \frac{z^2}{B_x^2} = 1$$

$$A_x = \frac{(d_1 - d_2)}{2}$$

$$B_x = \sqrt{D^2 - A_x^2}$$

Cochlée A      2 D      Cochlée B

Hémisphère 1 :  
A devance B

Hémisphère 2 :  
B devance A

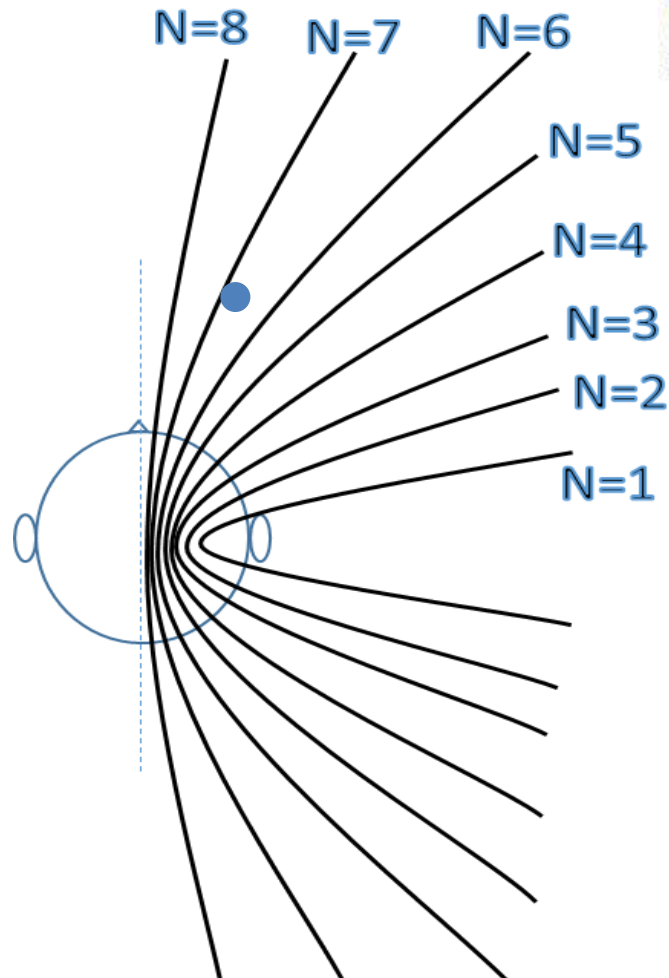
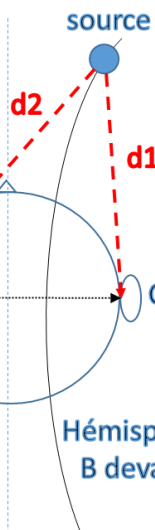

# Conclusion

- ULP Artificial cochlea presented :
  - 100 nW / Channel (w/o buffer)
- Challenges :
  - Biodiversity monitoring (Ceteceans, not only)
  - Digital transition (Data deluge ↓)
- Key applications (biodiversity monitoring) :
  - Classification
  - Tracking
  - Anthropogenic noise impact ? (human activities)

Tous droits réservés