



HAL
open science

Detection Techniques and Fundamental Limits in Frequency Stabilization via Spectral Hole Burning

M T Hartman, X Lin, B Pointard, R Le Targat, S Seidelin, P Goldner, B Fang, Y Le Coq

► To cite this version:

M T Hartman, X Lin, B Pointard, R Le Targat, S Seidelin, et al.. Detection Techniques and Fundamental Limits in Frequency Stabilization via Spectral Hole Burning. Assemblée générale de la Fédération de Recherche FIRST-TF 2023, Nov 2023, Nice, France. 2023. <hal-04460577>

HAL Id: hal-04460577

<https://hal.science/hal-04460577v1>

Submitted on 15 Feb 2024

HAL is a multi-disciplinary open access archive for the deposit and dissemination of scientific research documents, whether they are published or not. The documents may come from teaching and research institutions in France or abroad, or from public or private research centers.

L'archive ouverte pluridisciplinaire **HAL**, est destinée au dépôt et à la diffusion de documents scientifiques de niveau recherche, publiés ou non, émanant des établissements d'enseignement et de recherche français ou étrangers, des laboratoires publics ou privés.



Distributed under a Creative Commons CC BY 4.0 - Attribution - International License

Collaboration



Detection Techniques and Fundamental Limits in Frequency Stabilization via Spectral Hole Burning

M. T. Hartman¹, X. Lin¹,
B. Pointard¹, R. Le Targat¹,
S. Seidelin^{2,3}, P. Goldner⁴,
B. Fang¹, Y. Le Coq¹

1. LNE-SYRTE, Observatoire de Paris, Université PSL, CNRS, Sorbonne Université - Paris, France
2. Nano-Optique et Forces, Institut NEEL, CNRS, UGA, Grenoble INP - Grenoble, France
3. Institut Universitaire de France - Paris, France
4. Institut de Recherche de Chimie, Paris Université PSL, Chimie ParisTech, CNRS - Paris, France

Ultra-Stable Lasers The State of the Art

In order for optical clocks to reach their ultimate performance (quantum projection limit, $\sim 10^{-17}$ fractional frequency stability at 1 s), they require an ultra-stabilized probe laser, setting a **goal of 10^{-18} at 1 s**.

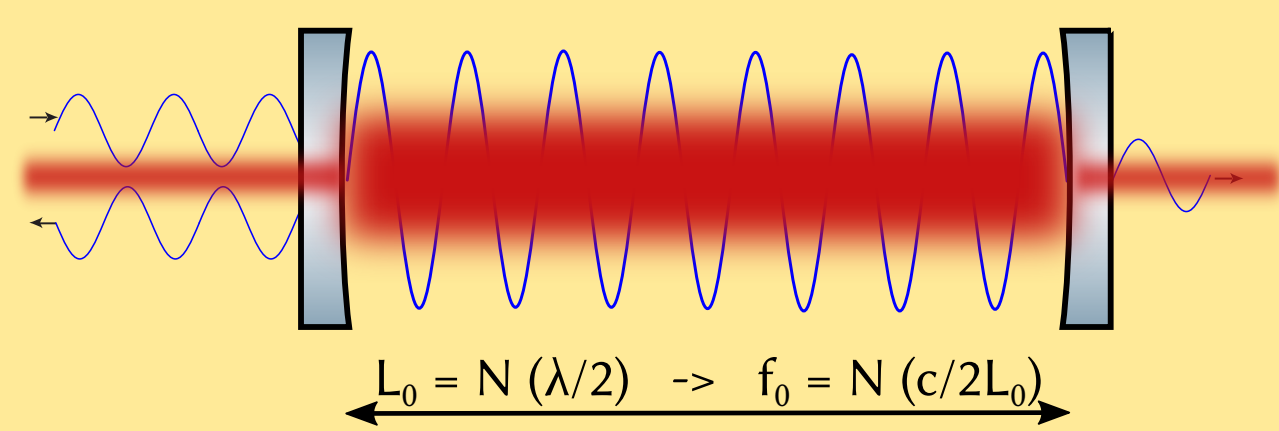

Traditionally, these lasers use length-stable optical cavities as a frequency reference.

Conventional cavities have a fundamental limit, due to thermal noise, at $\sim 10^{-16}$ at 1 s. Efforts to mitigate thermal noise include alternate cavity geometries, use of high-Q materials, and cryogenic cavities.

- PTB, JILA^[1]: Cryogenic Cavities: 4×10^{-17} at 1 s
- PTB^[2]: Long Cavities: 8×10^{-17} at 1 s

While successful, this route faces considerable technological challenges.

- [1] D. G. Matei, et al., *Phys. Rev. Lett.* **118**, 263202 (2017).
[2] S. Häfner, et al., *Opt. Lett.* **40**, 2112-2115 (2015).

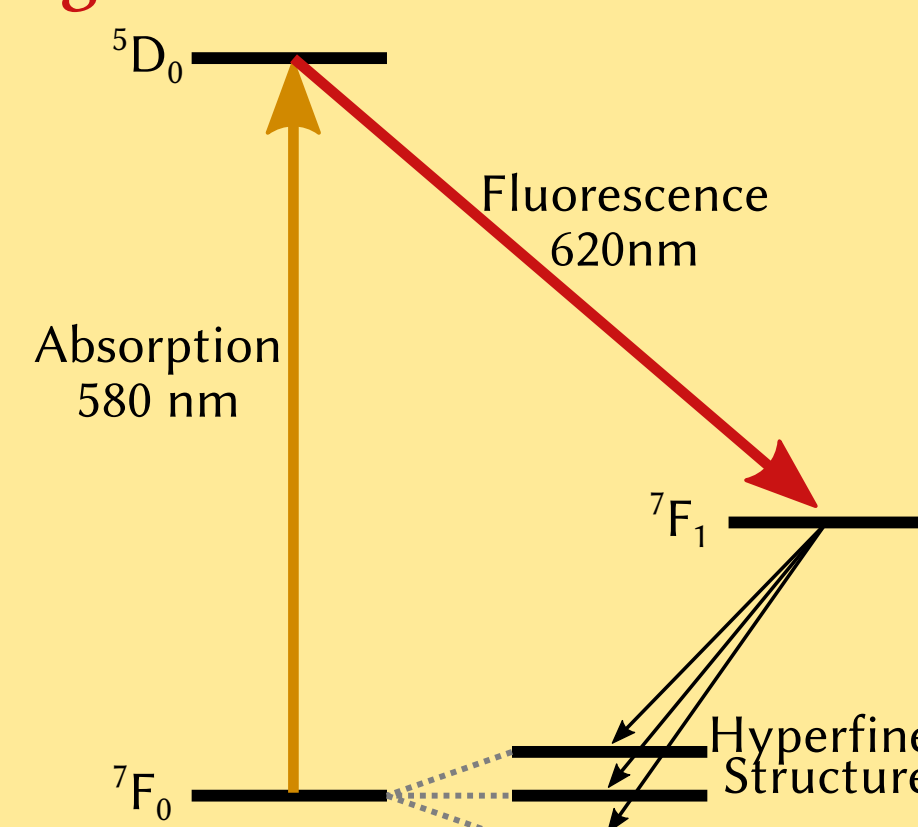

We are researching a potential **paradigm shift in ultra-stable lasers: stabilization to an optical transition of a rare earth ion, Europium (Eu^{3+}), doped into an Yttrium Orthosilicate (Y_2SiO_5)**.

Spectral Hole Burning (SHB)

The ${}^7\text{F}_0 \rightarrow {}^5\text{D}_0$ transition in Eu^{3+} has a narrow homogeneous absorption line of order ~ 100 Hz.

Within the crystal, inhomogeneous constraints lead to a broadening of the absorption spectrum.

A narrow linewidth pump beam at 580 nm excites the ions, which drop into a hyperfine state.

Pumping-out all the ions at one frequency produces a narrow transmissive 'spectral hole' in the absorption spectrum.

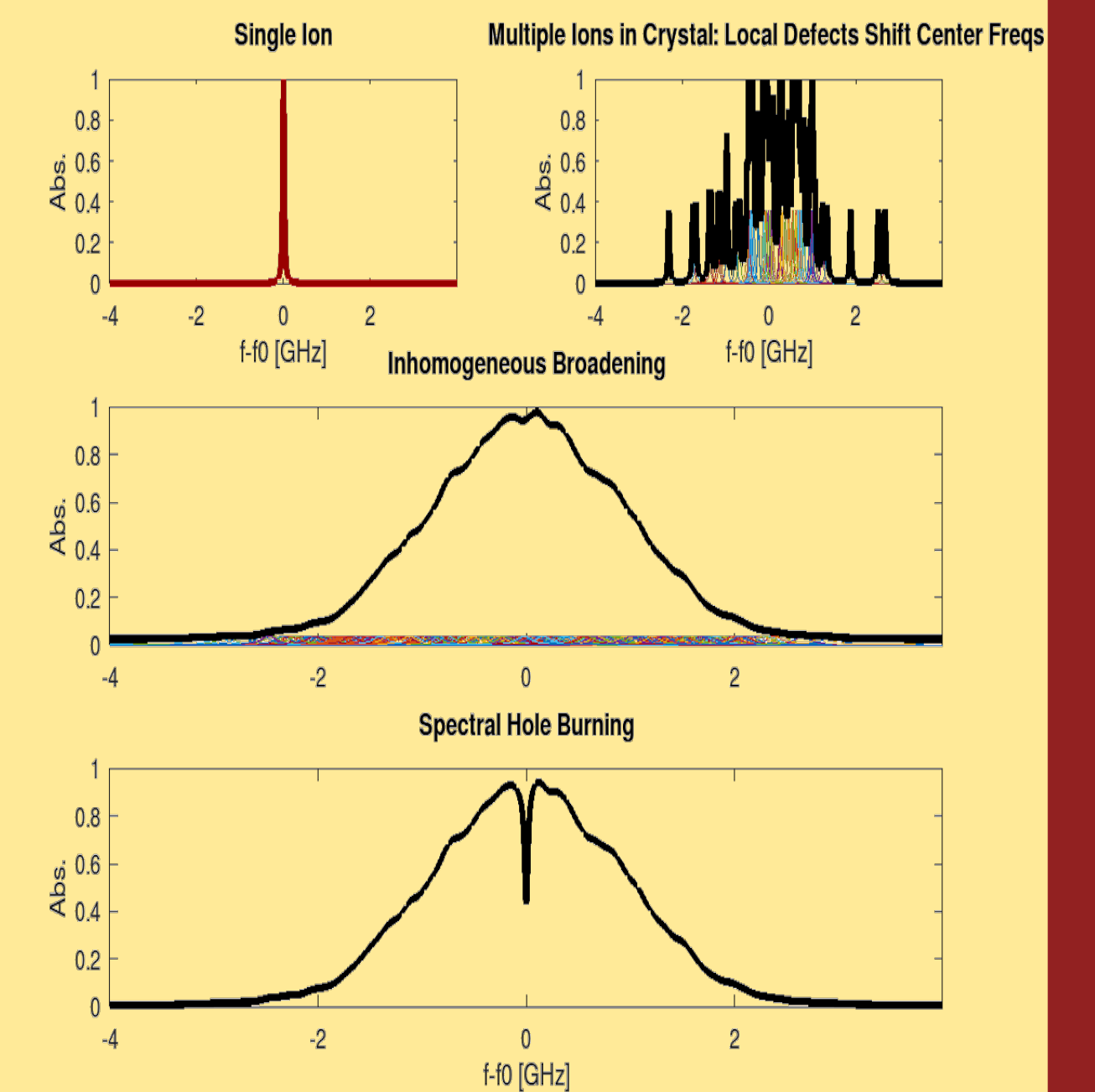

Experimental Setup

A slave laser is phase-locked to a cavity-referenced pre-stabilized master laser at 1160 nm. The slave is frequency doubled and tuned to the absorption band of the $\text{Eu}^{3+}:\text{Y}_2\text{SiO}_5$ crystal. The desired spectrum of beat notes is generated on the slave by an AOM driven by a GNU Radio controlled Ettus X310 FPGA-based SDR.

At high power (1 uW) the slave laser acts as the pump, burning the spectral holes. Switching to low power (10 nW), it probes the holes, experiencing a phase retardation proportional to the frequency difference between the laser modes and spectral holes.

This phase difference, $\phi_{p_i}(t) = \phi_{p_i}^{\text{Xtal}}(t) - \phi_{p_i}^{\text{Ref}}(t)$, is measured in the FPGA, comparing the transmitted beat note on PD^{Xtal} with a reference beat on PD^{Ref} . The FPGA generates the correction signal tuning the PLL offset.

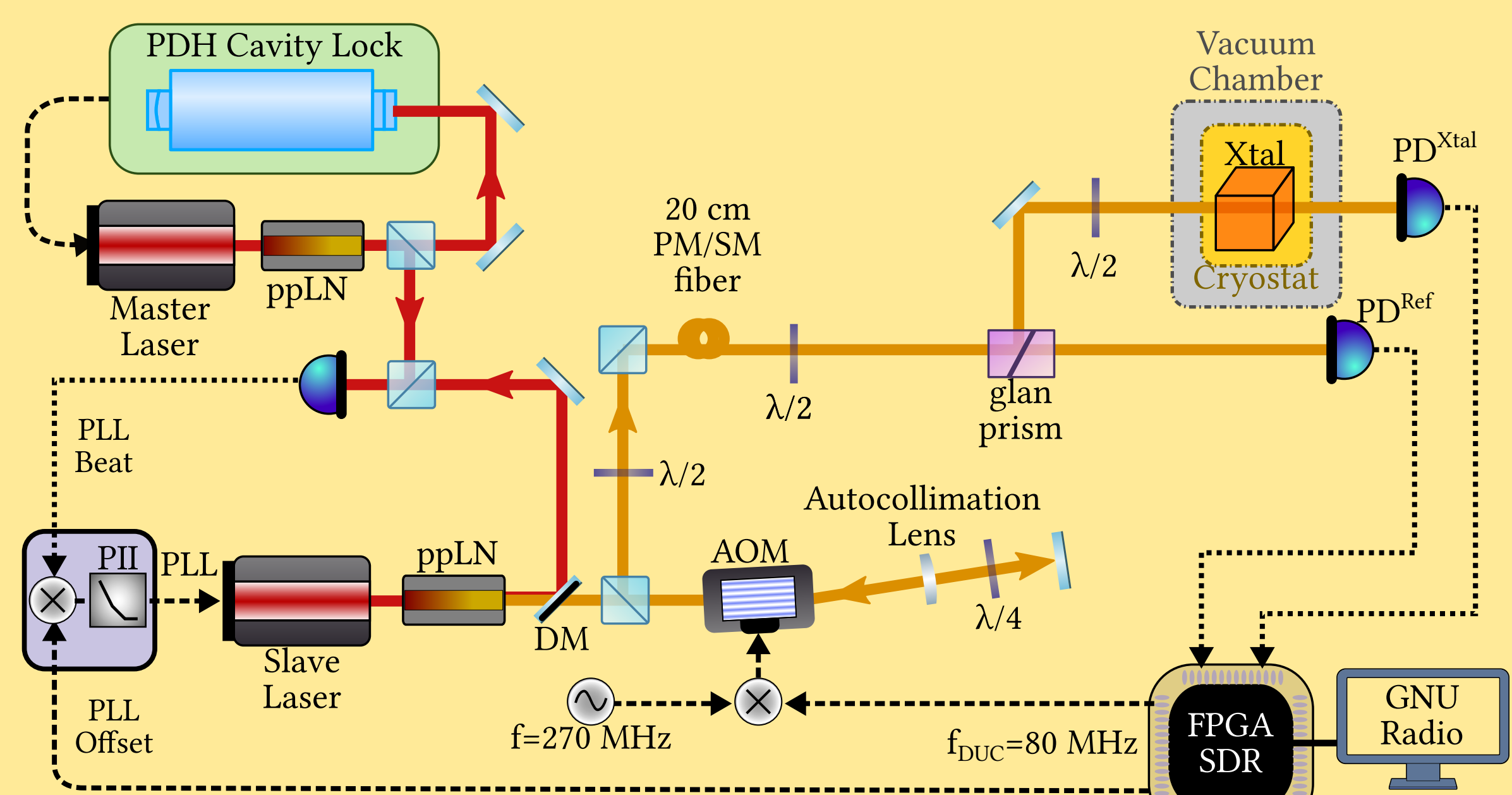

Multi-mode Heterodyne Detection^[3]

We implemented a novel multi-mode detection scheme to reduce sensing noise. In this scheme we probe multiple narrow spectral holes simultaneously using corresponding laser probe modes, p_i : $\bar{\phi}_{p_i}(t) = \frac{1}{N} \sum_{i=1}^N \phi_{p_i}(t)$
Below: We average over the modes, reducing uncorrelated noise.

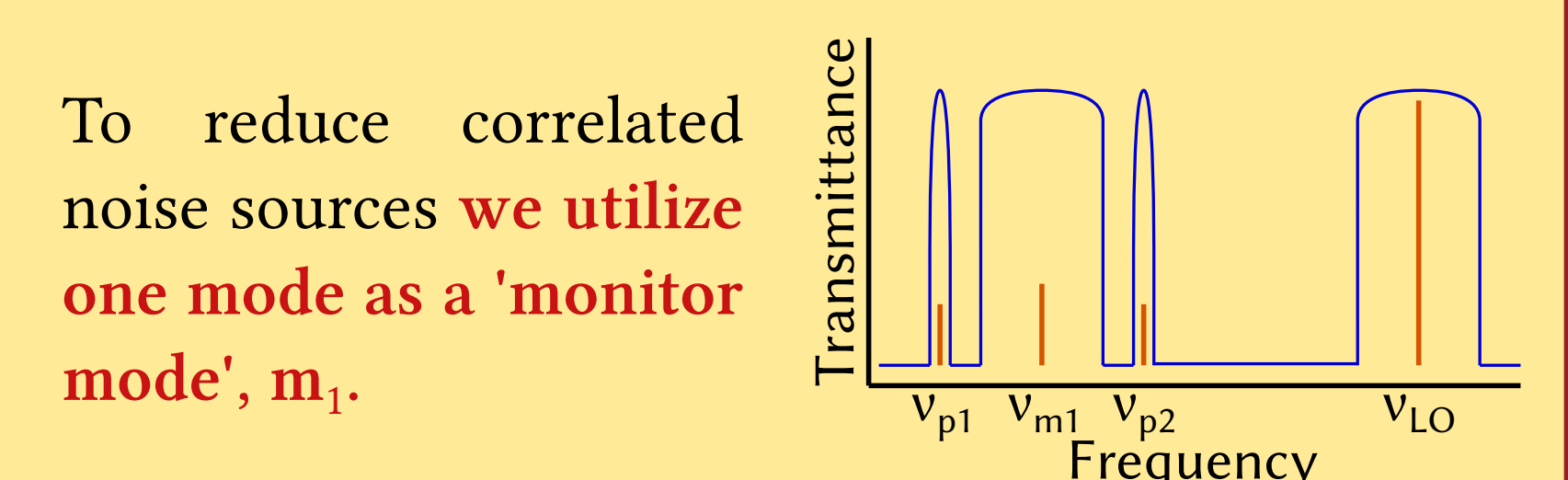
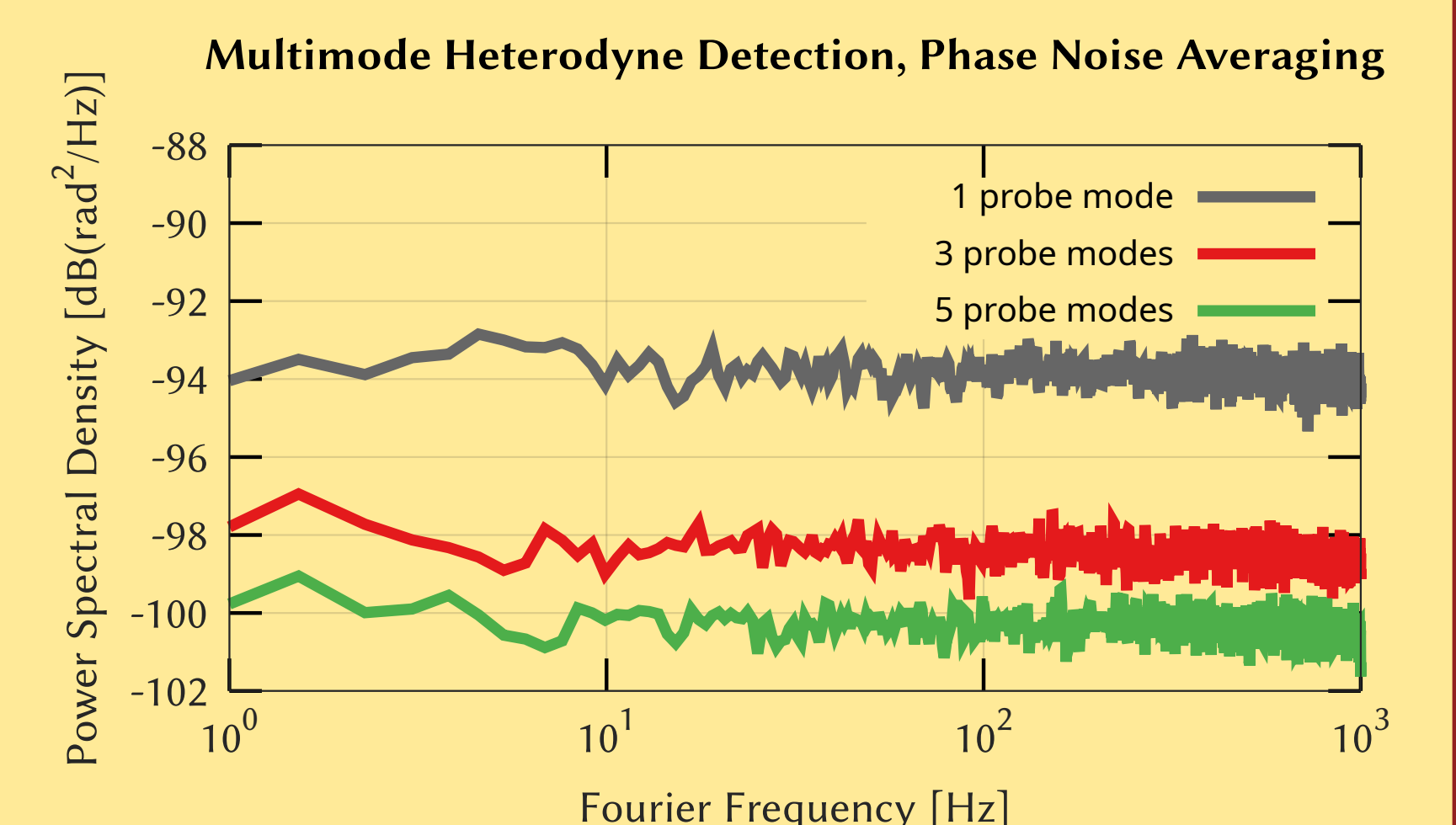

To reduce correlated noise sources we utilize one mode as a 'monitor mode', m_1 .

Above: Propagating on the same beam, the monitor mode passes through a broad 'square' spectral hole, accumulating common-mode phase noise from sources such as parasitic interferometers.

Below: Subtracting path-length noise in real-time has yielded high common-mode noise rejection into the thousands of seconds of integration time.

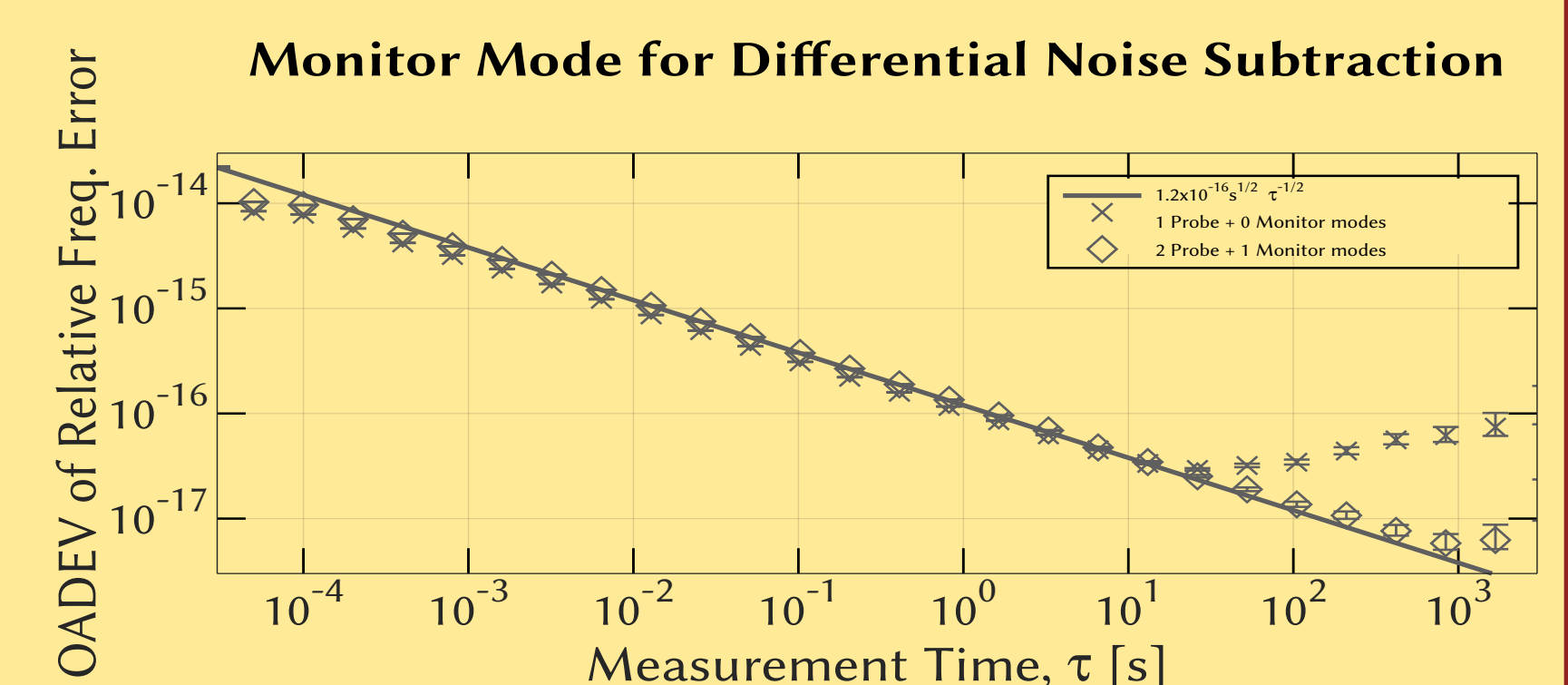

[3] X. Lin, *Opt. Express*, **31**(23), 38475-38493 (2023).

Spectral Hole Line Shifts at $< 1\text{K}$ ^[5]

Early measurements in our experiment^[4] found frequency noise that is compatible with spectral hole (SH) temperature-induced line shifts at $T \sim 4$ K combined with the temperature stability of our cryostat. This motivated the addition of a custom dilution refrigerator (MyCryoFirm) where, at temperatures < 1 K, we expected a **4 order-of-magnitude reduction in temperature sensitivity**. With the laser frequency locked to the SH, we measured the SH temperature sensitivity in two ways^[5]: 1) we ramp the temperature and measure the frequency shift of the SH-locked laser against the SYRTE frequency comb, the temperature sensitivity is the derivative of this shift. 2) we modulate the temperature while recording the laser frequency against the comb. Demodulation of these signals reveals the temperature sensitivity directly, the integration of this signal indicates the temperature shift.

Currently, we are collaborating with LENA (U. Braunschweig) to measure the mechanical loss angle of Y_2SiO_5 . This, combined with our temperature shift measurements, will allow us to develop a suite of thermal noise models to understand the fundamental stability limit.

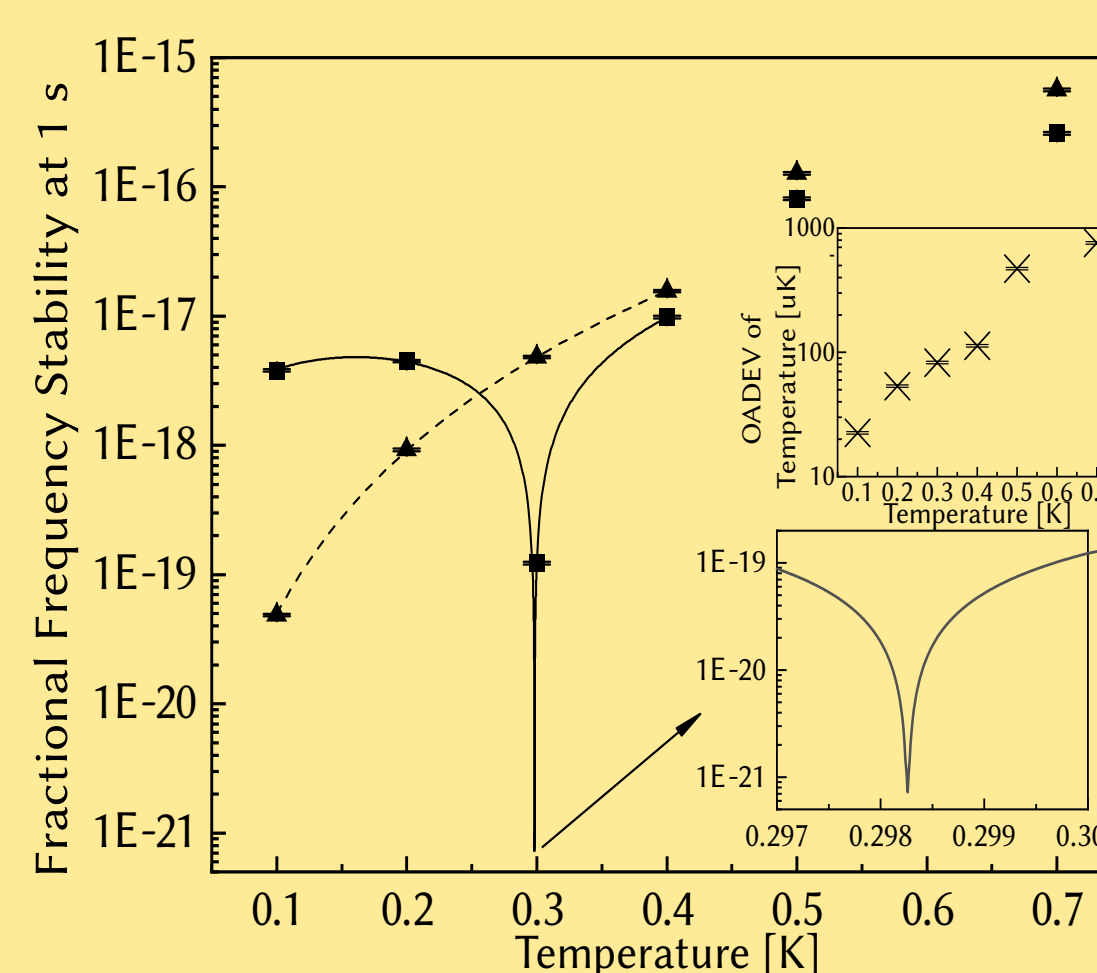

Left: The measured frequency shift in a spectral hole at dilution temperatures. At spectroscopic site 2, the line shift roughly follows the expected T^4 dependence, however at site 1 a large deviation from this trend reveals a local minimum around 300 mK **providing a region of temperature insensitivity to first order**. Above: Measured cryostat temperature stability and SH temperature sensitivities reveals a region with temperature induced fractional frequency instabilities $< 10^{-20}$.

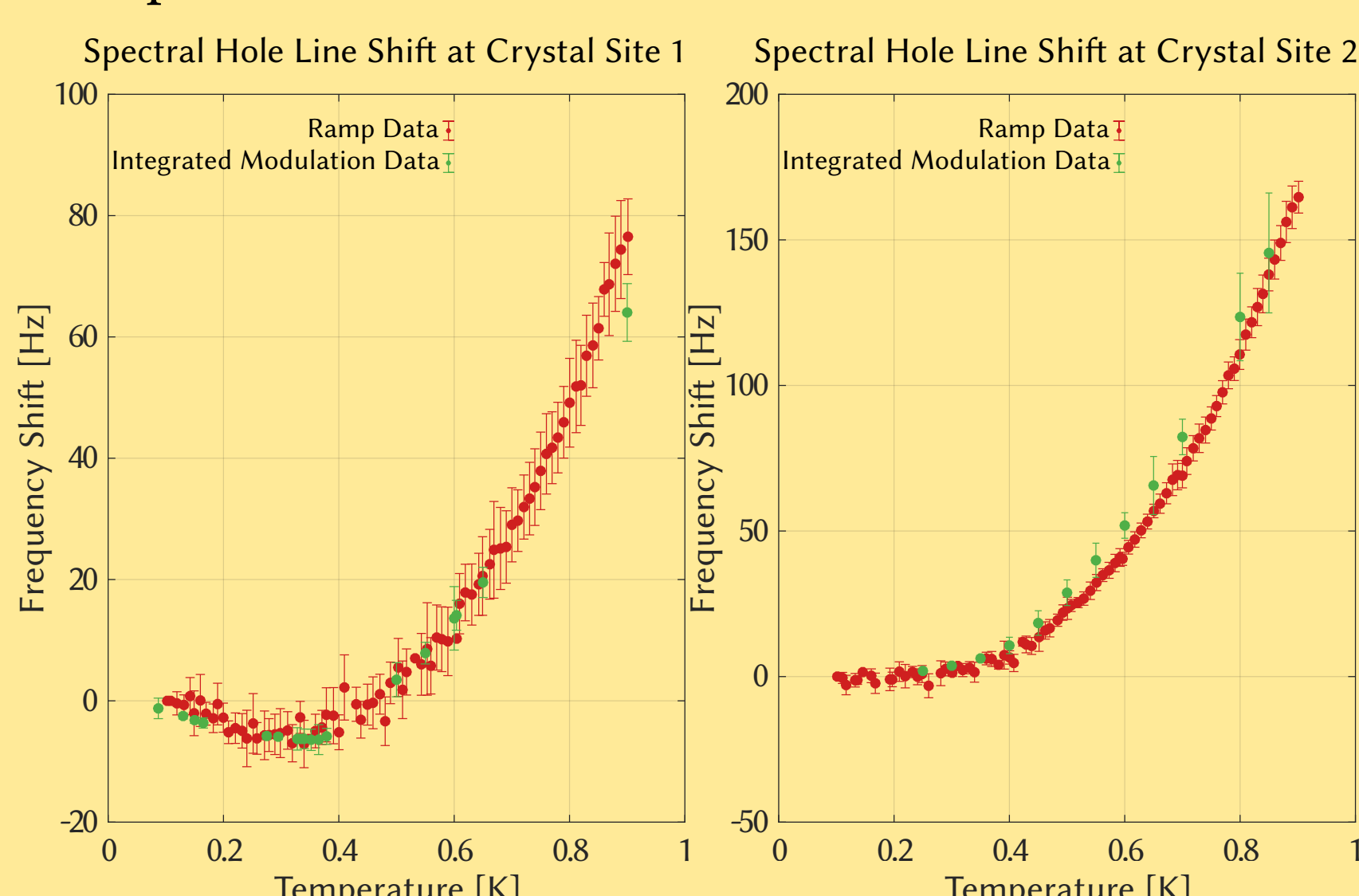

- [4] N. Galland, et al., *Opt. Lett.*, **45**, 1930-1933 (2020).
[5] Manuscript in Preparation.

Thanks To

