



HAL
open science

Physics-based simulations for assessing the playability of heritage musical instruments: Impact of the soundboard assembly process on its low frequency behavior

Victor Almanza, Sandie Le Conte, Stéphane Vaiedelich, Emmanuel Foltête, Romain Viala, Andrés Felipe Arciniegas Mosquera, Loïc Martinez, Nicolas Wilkie-Chancellier, Stephane Serfaty, Vincent Placet, et al.

► To cite this version:

Victor Almanza, Sandie Le Conte, Stéphane Vaiedelich, Emmanuel Foltête, Romain Viala, et al.. Physics-based simulations for assessing the playability of heritage musical instruments: Impact of the soundboard assembly process on its low frequency behavior. *Applied Acoustics*, 2023, 214, pp.109672 (11). 10.1016/j.apacoust.2023.109672 . hal-04456525

HAL Id: hal-04456525

<https://hal.science/hal-04456525>

Submitted on 14 Feb 2024

HAL is a multi-disciplinary open access archive for the deposit and dissemination of scientific research documents, whether they are published or not. The documents may come from teaching and research institutions in France or abroad, or from public or private research centers.

L'archive ouverte pluridisciplinaire **HAL**, est destinée au dépôt et à la diffusion de documents scientifiques de niveau recherche, publiés ou non, émanant des établissements d'enseignement et de recherche français ou étrangers, des laboratoires publics ou privés.

Physics-based simulations for assessing the playability of heritage musical instruments: Impact of the soundboard assembly process on its low frequency behavior

Victor Almanza¹, Sandie Le Conte², Stéphane Vaiedelich³, Emmanuel Foltête⁴,
Romain Viala^{5,6}, Andrés Felipe Arciniegas Mosquera¹, Loïc Martinez¹,
Nicolas Wilkie-Chancellor¹, Stéphane Serfaty¹, Vincent Placet⁴, Scott Cogan⁴

¹Laboratoire Systèmes et Applications des Technologies de l'Information et de l'Énergie (SATIE),
CNRS UMR 8029, CY Cergy Paris Université

²Institut National du Patrimoine, Laboratoire de Recherche,
Département des Restaurateurs

³Philharmonie de Paris – Centre de Recherche sur la Conservation (CRC),
Muséum National d'Histoire Naturelle, CNRS, Ministère de la Culture

⁴Institut FEMTO-ST, UMR CNRS 6174, Université Bourgogne Franche-Comté,
Department of Applied Mechanics

⁵Institut Technologique Européen des Métiers de la Musique, ITEM, Le Mans

⁶Laboratoire d'Acoustique de l'Université du Mans — LAUM CNRS 6613 —
Le Mans Université, Avenue Olivier Messiaen, 72085 Le Mans Cedex 09, France

September 21, 2023

Abstract

Curators of heritage musical instruments are faced with a number of recurring questions concerning the objects in their collection. Can the instrument be played without damaging it? How might it best be restored? Can we understand how and why the instrument evolved in the way it did and the impact of the different steps in its construction? Indeed, the impact of the different steps in the assembly of a musical instrument must be anticipated in order to assess its playability. Curators may question whether the state of internal stress, deliberately introduced by the instrument maker during the assembly process, should be restored after it has relaxed over time. These questions are typically answered through expert judgement. Meanwhile, it may be possible to leverage detailed physics-based models to enrich the decision support in the museum environment. This novel strategy is illustrated in the present study to investigate the importance of the different steps in the assembly process in order to guide the restoration process. In particular, numerical and experimental studies that have been carried out on a facsimile of the soundboard of the Christoph Koch's archlute of 1654 (E.546) with the objective of quantifying the impact of its assembly and gluing processes on the low frequency vibratory behavior. It is shown that a nominal non validated numerical model is able to predict trends, validated via experimental studies, that can be useful in understanding the impact of the assembly process in order to guide future restorative measures.

Keywords: Numerical simulations, experimental studies, decision-making support, heritage musical instruments, soundboard assembly process, mechanical behavior.

Highlights

- Recurring questions facing curators of heritage musical instruments concerning their state of playability
- Museum decisions concerning instrument restoration and playability can be informed by leveraging detailed physics-based models
- Internal mechanical stresses are oftentimes purposely introduced by the luthier in the fabrication and assembly process of a stringed musical instrument
- Non-validated physics-based models can be leveraged to predict useful trends
- Uncertainty in the gluing process has a higher impact on the low frequency behavior of the soundboard than uncertainty in the assembly process

1 Introduction

Historical musical instruments, which have been in use for musical presentation up to the present day, are the subject of research and study in various countries of the world [1].

All museums that host a collection of musical instruments face several problems, such as, how best to describe the story of music through its instruments, how to preserve and restore heritage musical instruments and how to assess their playability. In regard to playability, the musée de la Musique de la Philharmonie de Paris houses a collection of more than 7000 instruments but only 5% of this collection is in a playable state.

Indeed, heritage musical instruments present many cultural values including, historical, technical, acoustic and aesthetic. These cultural values are subjectively compared and hierarchized. The aim of this work is to provide an objective and quantifiable response to assessing the playability of a heritage musical instruments.

Regarding wooden stringed musical instruments and more particularly their soundboards, the materials chosen are extremely varied including, skins, woods, metals, glass. The present work focuses on wooden soundboards.

Assessing the playability of wooden stringed musical instruments raises many questions. Indeed, a variety of factors influences the mechanical state, stress and strain state, of wooden stringed musical instruments. A distinction is made between the mechanical state induced by the string tension under normal playing conditions from that induced by the instrument maker during the construction of the instrument and in particular the methods of assembling the instrument parts. So, a curator might wonder whether the state of internal stresses, intentionally introduced by the luthier in the process of making and assembling of a stringed musical instrument, has a significant impact on the vibroacoustic behavior of the instrument and

therefore should be restored after it has relaxed over time given the viscoelastic behavior of wood. In this work we will focus on the impact of the mechanical state induced by the instrument makers during the construction and assembly of the soundboard on its low frequency vibratory behavior.

A brief look at the chronological evolution of the guitar shows that the making gestures, particularly those concerning the reinforcement systems most often referred to as "bracings", have become increasingly complex and sophisticated (fig.1). The techniques and assembly methods used to design these structures play a key role in their artistic inspiration, as changes in their mechanical behaviour influence their intangible values, i.e. the acoustic qualities intrinsically present in these works. However, the initial state of these voluntarily added constraints is inevitably subject to change over time, given the viscoelastic behavior of wood.

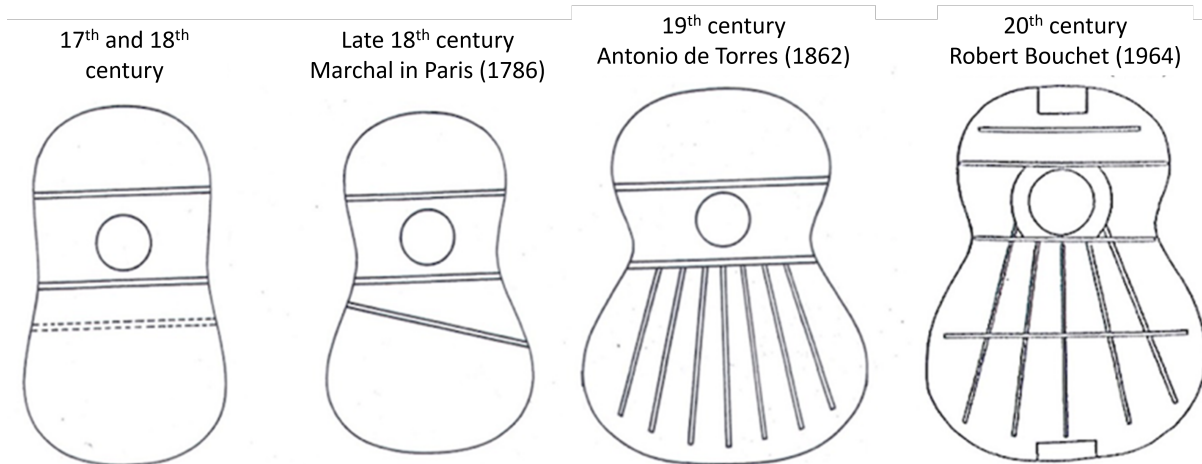

Figure 1: Evolution of guitar bracing : from the 17th to the 20th century, guitar structural systems became extraordinarily complex. Adapted from D. Friedrich, *Citéscopie : la guitare*, Cité de la musique, 1995 [2]

The types of bracing and their assembly methods differ according to instrument families, historical periods, schools and making styles. Although they vary widely in the detail of their execution, bracing techniques can be grouped into two categories, according to common mechanical criteria: those using external forces and those using the mechanosorptive behavior of wood [3].

Several approaches have been used to study the mechanical behaviour of musical instruments, including experimental approaches using direct [4, 5, 6, 7] or indirect [8, 9] vibration measurement methods, analytical approaches [10, 11, 12, 13, 14] and virtual prototyping approaches [15, 16] using the finite difference method (FDM) [17, 18], the boundary element method (BEM) [19, 20, 21] or the finite element method (FEM) [6, 9, 22].

The vibration behavior of structures with an initial state of non-zero strains and stresses has been widely studied [23, 24]. The interpretation of the observations strongly depends on the structure, but also on how the initial state has been introduced. Despite the rich literature, the immediate knowledge transfer of these observations to wooden soundboards is not immediate. Indeed, very few studies exist concerning the impact of the initial mechanical state of a musical instrument on its vibratory behavior. This question has been studied concerning the effects of nonlinearities due to the static load of piano strings [25]. More recently, the presence of manufacturing pre-stress in wooden soundboards has also been highlighted [3].

Over the last decade, the introduction of structural calculations to support the conservation-restoration program to maintain instruments in a playable state has provided new methodological and practical perspectives [9, 26, 27]. Moreover, numerical and experimental studies have already been carried out to investigate the impact of the string tension and of the assembly process on the vibratory behavior of a piano soundboard or simplified soundboards, for example [28, 29].

In spite of these studies, many unknowns remain given the unique nature of each instrument including the uncertainties inherent to the manual fabrication process as well as the spatial and temporal variability of the wood material.

In parallel, virtual prototyping has become a standard tool in the industrial world. In the field of structural

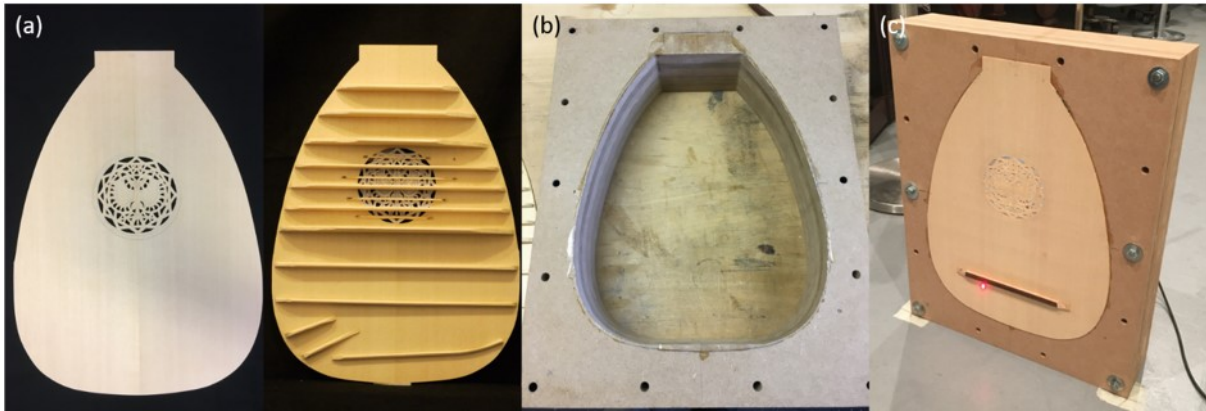

Figure 2: Pictures of (a) Christoph Koch's archlute soundboard facsimile, (b) MDF block and (c) resulting structure

mechanics, numerical models are most often produced using the finite element method. For the last twenty years, an approach known as "Verification and Validation of Simulations" (V&V) has been developed, which consists in developing guidelines and decision support tools based on numerical simulations, or how to estimate the confidence that can be placed in a numerical simulation given the presence of uncertainties [6, 30, 31, 32].

The work carried out in this paper aims to develop a decision support methodology usable in a museum context and based on the virtual prototyping paradigm to study the static and dynamic behavior of historical musical instruments to optimize its conservation and its preservation in playing conditions but also to anticipate costly or time-consuming experimental campaigns. To illustrate this decision support methodology, a procedure was set up to determine if an unvalidated numerical model is able to predict useful trends for decision support in a museum context. The numerical and experimental studies are carried out on a facsimile of the soundboard of the Christoph Koch's archlute of 1654 (E.546) in order to evaluate the impact of its assembly process and gluing on its low frequency vibratory behavior.

The methods used for this procedure are presented in the next section, followed by the results and a discussion section. Finally, the conclusion and perspectives will be presented.

2 Methods

This section presents the studied case, the numerical simulations, the experimental protocol and the features and metrics.

2.1 Case study

Within the framework of this study, a facsimile of the soundboard of Christoph Koch's archlute was made by an expert in conservation and restoration. The soundboard and bars are made of spruce, *Picea abies*, while the bridge is made of pear tree, *Pyrus communis*. The table has a height of approximately 420mm and a maximum width of approximately 305mm. The facsimile can be seen on figure 2.a. The soundboard is glued to the body of the instrument all over its edge. To reproduce these boundary conditions, a MDF (Medium Density Fiberboard) block was manufactured (figure 2.b) on which the facsimile is glued with an animal glue. The resulting structure is shown in figure 2.c.

Regarding the bracing process, flat bars are glued to the soundboard using a curved working counterform. A curved working counterform was designed with a 3 mm gap between its center and ends.

Moreover, after the assembly of the table with the brace, the soundboard is glued to the body of the instrument, which is generally not flat, modifying again its mechanical state. In order to study this assembly step, two types of MDF blocks were used: a flat MDF block and a carved MDF block with the curvature of the instrument body. In order to design the carved MDF block, the arch of the ribs (body) of Christoph Koch's archlute was measured with relaxed strings by surface scanning.

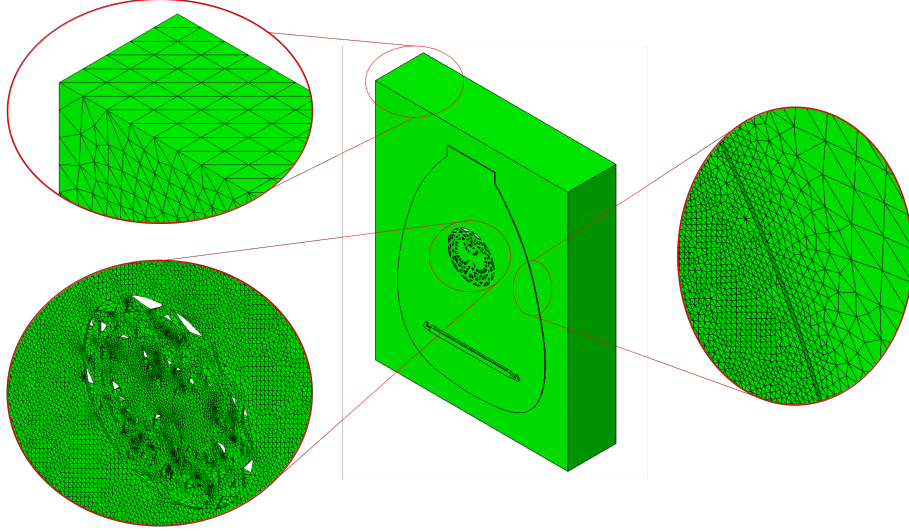

Figure 3: Facsimile and MDF block meshes

In order to dissociate the impact of the table assembly with its brace on the low frequency behavior of the soundboard from the effect induced by the assembly of the soundboard with the body of the instrument, a strategy was developed based on three different configurations:

- A first reference configuration in which the soundboard is braced with the flat bars without using the counterform (its mechanical state is therefore unchanged) and the soundboard is glued to the flat MDF block (configuration C0).
- A second configuration in which the soundboard is braced with the flat bars without using the counterform, and the soundboard is glued to **the carved MDF block** (configuration C1).
- A third configuration in which the soundboard is braced with the flat bars **using the curved counterform** and the soundboard is glued to the carved MDF block (configuration C2).

Moreover, since these operations require the gluing and ungluing of the soundboard, it was necessary to evaluate the impact of the gluing on the vibratory behavior of the soundboard in order to be able to dissociate it from the one of the assembly steps.

2.2 Numerical simulations

SolidWorks[®] 3D computer-aided design software was used to create the geometric models of the soundboard and the flat and carved MDF blocks. The 3D model of the soundboard was designed from the drawings that were used to make the soundboard.

ABAQUS finite element software was used for all structural calculations, including static calculations for the determination of the mechanical state resulting from the assembly steps and modal analyses for the determination of the natural frequencies and the corresponding mode shapes of the system. It has been observed that, for wooden stringed musical instruments, modal damping is very low [33], so our model is assumed to be undamped. The eigenvalue problem for the natural frequencies is given by:

$$(-\omega_i^2 M + K) \phi_i = 0 \quad (1)$$

where $M, K \in \mathbb{R}^{N,N}$ are the mass and stiffness matrices and ω_i, ϕ_i the i^{th} eigensolutions.

The soundboard and the MDF blocks were modeled with C3D10 tetrahedral elements. Due to the presence of the rosette, and after a mesh convergence study, the structure studied is made up of 216802 elements of 3mm. The meshes of the facsimile and the MDF block are shown in figure 3.

Since the aim of this study is to assess the ability of an uncalibrated numerical model to predict trends that may be useful for decision making, wood is modeled with orthotropic linear elastic behavior, and the

Parameters	Values
ρ (g/cm ³)	0.38
E_L (MPa)	10200
E_R (MPa)	850
E_T (MPa)	500
ν_{LR} (\emptyset)	0.39
ν_{LT} (\emptyset)	0.43
ν_{RT} (\emptyset)	0.50
G_{LR} (MPa)	750
G_{LT} (MPa)	675
G_{RT} (MPa)	75

Table 1: Material properties of the various facsimile components

Parameters	Values
ρ (g/cm ³)	0.75
E (MPa)	4000
ν (\emptyset)	0.3

Table 2: Material properties used for the MDF block

values applied for the parameters governing this behavioral model have been obtained from the literature [6, 34]. The material properties used for the various facsimile components are shown in table 1 and those used for the MDF block in table 2. In addition, given the orthotropic nature of the wood material constituting the facsimile, the material orientation has been implemented for each component of the facsimile and is presented in figure 4.

Modal analyses were performed under free condition between 10 and 1200 Hz for the C0 configuration and between 10 and 1500 Hz for the others.

To model the configuration C0, the nodes of the soundboard and the flat MDF block are linked, and a modal analysis is performed.

To model the configuration C1, a load is applied around the perimeter of the soundboard until it matches the arch of the carved MDF block. Then, the nodes of the soundboard and the carved MDF block are linked and the load is removed to obtain an elastic return. A modal analysis is then performed in this state.

To model the configuration C2, a load is applied to the bars of the soundboard until it matches the arch of the concave worktable. Then, the nodes of the table and the bars are linked and the load is removed in order to obtain an elastic return. A load is then applied around the perimeter of the soundboard until it matches the arch of the carved MDF block. Finally, the nodes of the soundboard and the carved MDF block are linked and the load is removed in order to obtain an elastic return. A modal analysis is performed in this state.

Several parameters can influence the gluing, such as the mechanical properties of the glue, its thickness or the gluing surface. In our case, we are interested in the impact of the latter on the soundboard's vibratory behavior. To study this impact, we compared two configurations in which a 0.15 mm thick film of glue [35] is introduced between the soundboard and the MDF block. The adhesive film is modeled with C3D10 tetrahedral elements and with an isotropic linear elastic behavior. The material properties of the latter were obtained from the literature [36] and are presented in table 3. The nodes on the surface of the glue film in contact with the facsimile are bonded to it, and those on the surface of the glue film in contact with the MDF block are also bonded to it. The first configuration, referred to as "C3" in the following, has a glue film covering the entire gluing surface. The second configuration, referred to as "C4" in the following, has a glue film covering only a portion of the gluing surface. To achieve this, a percentage of the glue film elements in configuration C3 were randomly removed. Two models of this configuration have been studied, one where the glue film covers 85% of the gluing surface and a second where the glue film covers 70% of the gluing surface. In the following, these models will be referred to as "C4-85" and "C4-70" respectively. Since element removal is random, 10 different simulations were carried out for each of these models.

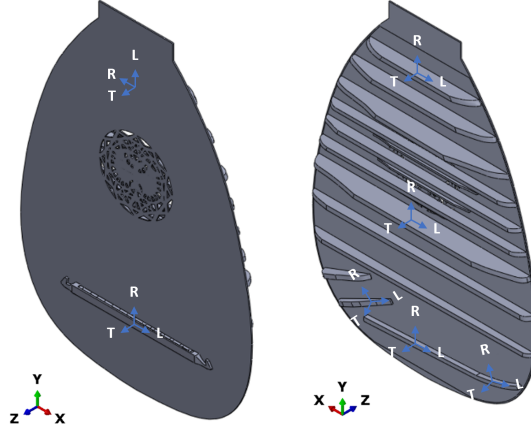

Figure 4: Material orientations used for the various facsimile components

Parameters	Values
ρ (g/cm ³)	1.27
E (MPa)	500
ν (\emptyset)	0.3

Table 3: Material properties used for the glue film

2.3 Experimental protocol

The dynamic behavior was studied by laser vibrometry using a Polytec PSV-500-3D scanning vibrometer. The vibrometer's three-dimensional calibration process allows us to define a reference coordinate system, and to precisely determine the positions and orientations of the three laser heads and the studied part within this coordinate system. The XY plane was defined as coincident with the front face of the facsimile. Measurements taken at each point in three different directions are used to reconstruct the three-dimensional velocity vector. Only the \vec{Z} component was used for modal identification and computation-test correlation. Its amplitude is 1 to 2 orders of magnitude greater than that of the other two components. This limits the pollution of data by low signal-to-noise ratio measurements, while ensuring rigorous computation-test correlation. The use of a 1D vibrometer could lead to similar results, but the measurement direction is generally assimilated to the optical axis, and its variation during the scan is usually neglected. The experimental setup is shown in 5.

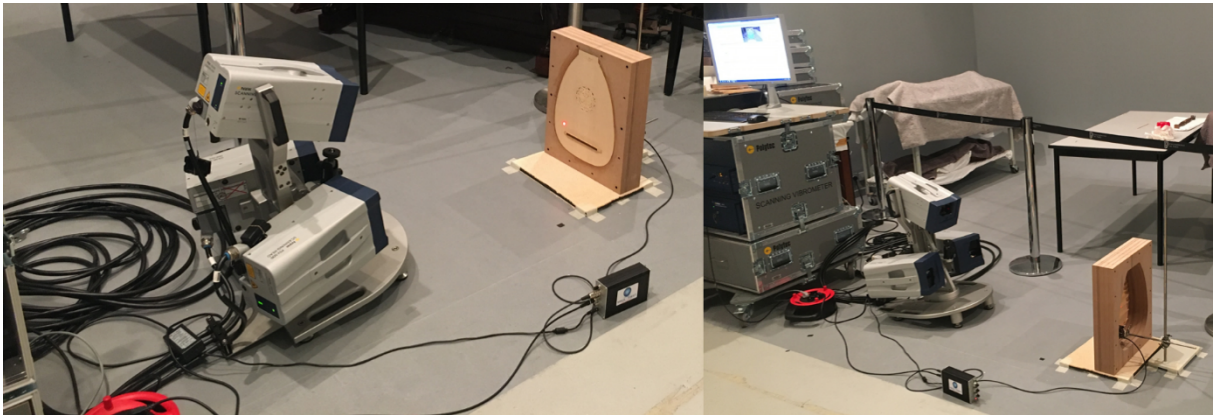

Figure 5: Experimental setup

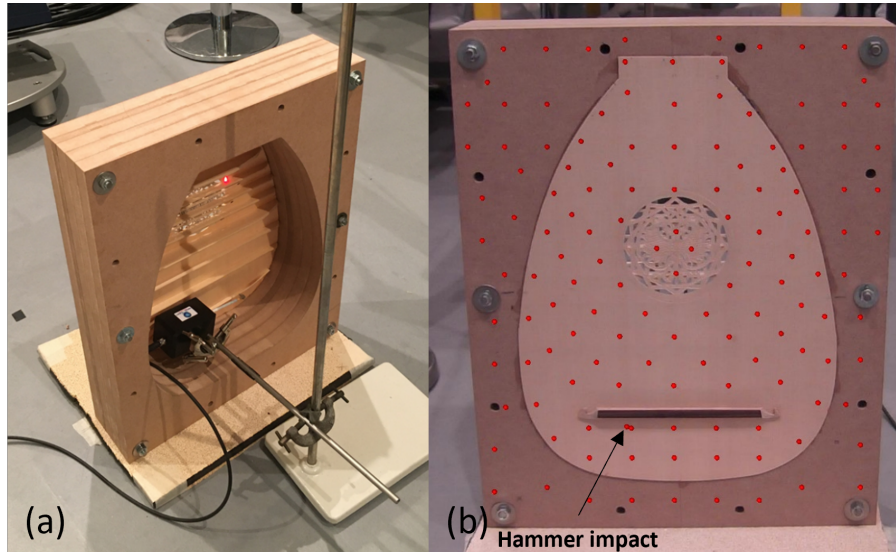

Figure 6: Pictures of (a) boundary conditions with excitation system and (b) experimental mesh

The different configurations presented below have been studied using the same boundary conditions. The structure, consisting of, the soundboard glued on the MDF block, is placed on foam and excited by an automatic impact hammer, «vImpact» MAUL-THEET, located at the back of the soundboard below the bridge. This disposition is shown in figure 6.a. The experimental mesh consists in 136 points, 87 of which are on the soundboard and 49 on the MDF block. Measurements were made on the MDF block in order to dissociate the soundboard modes from the global structural modes. The experimental mesh is shown in figure 6.b.

The measurements lasted approximately 30 minutes and were carried out between 10 and 2000 Hz with a frequency resolution of 0.6 Hz. Three averages were made for each measurement. Since the impact hammer signal decreased by 10 dB after 1200 Hz, modal analyses were performed between 10 Hz and 1200 Hz. The different experimental measurements were carried out in a room maintained at $22^{\circ}\text{C} \pm 1^{\circ}\text{C}$ with a relative humidity of $55\% \pm 5\%$.

Firstly, an experimental campaign was carried out in configuration C0. For this, the soundboard was glued to the flat MDF block. This campaign was also used to study the repeatability of measurements over a day. Nine measurements were made throughout a day in this configuration.

To study the impact of the assembly of the soundboard with the body of the instrument, four new measurements were performed in configuration C0. Then, an experimental campaign was carried out in configuration C1. For this, the soundboard was unglued from the flat MDF block and reglued to the carved MDF block (figure 7). Then, four measurements were conducted in this configuration and these measurements were compared to those obtained in configuration C0.

To study the impact of the assembly of the table with its braces, four new measurements were performed in configuration C1. Then, an experimental campaign was then carried out in configuration C2. For this, the soundboard was unglued from the carved MDF block and the bars of the soundboard were unglued from the table in order to be able to reglue them to the table by forcing them on the concave worktable (figure 8). Finally, the soundboard was reglued to the carved MDF block and four measurements were made in this configuration. These measurements were compared to those obtained in configuration C1.

Since the soundboard has been unglued from the MDF block and reglued between each of these experimental campaigns, it is necessary to study the impact of the gluing on the vibratory behavior of the soundboard in order to distinguish the variations observed due to the assembly steps from those resulting from the gluing. Hence, another experimental campaign was performed to study the impact of the gluing. Three different gluing operations were therefore carried out by three different experts and measurements were made for each of the gluing operations. Six measurements were made for the 1st gluing, two measurements for the 2nd and nine measurements for the 3rd.

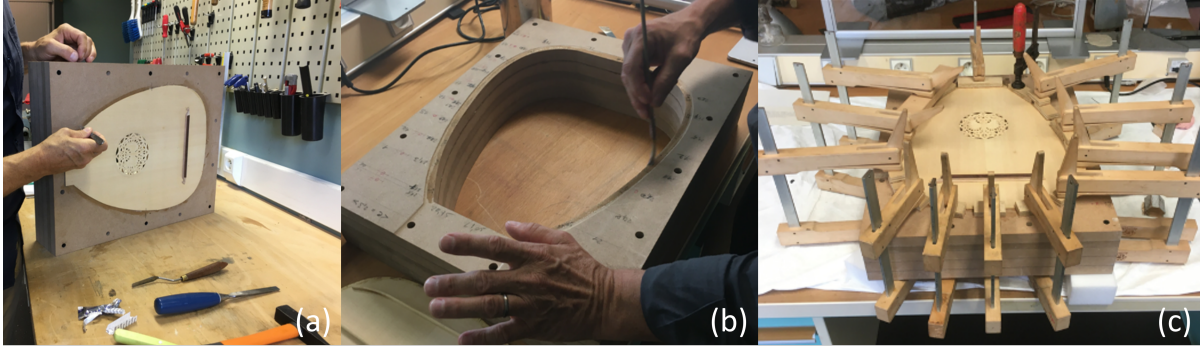

Figure 7: Pictures of the (a) ungluing and (b,c) regluing of the soundboard on the carved MDF block

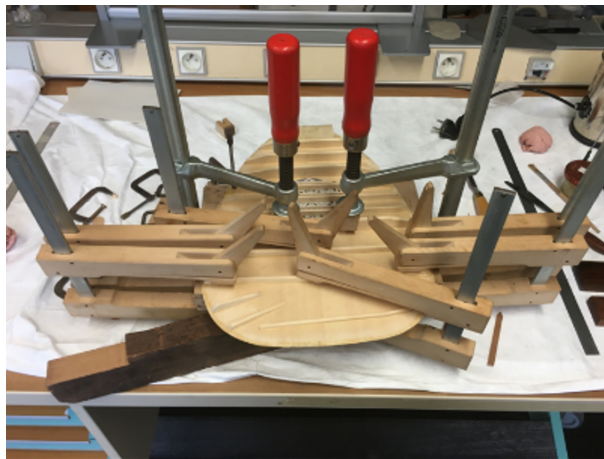

Figure 8: Pictures of bars forcing on the soundboard using the curved working counterform

2.4 Features and metrics

To study the impact of the different stages of assembly of the soundboard on its low frequency behavior, we have chosen to focus on the soundboard’s eigenfrequencies, since the characterization and the modelization of the damping remain a real challenge given its multiple origins, such as the damping relative to the wood material, which is inhomogeneous, or the damping in the links due to the gluing of the various parts of the instrument. However, as previously stated, the purpose of this study is not to match the frequencies obtained numerically and experimentally but to see if the numerical model, although imperfect, is capable of predicting the trends observed experimentally.

Regarding the experimental results, the frequency response functions were obtained from the Polytec PSV-500 software and the modal analyses were performed with the in-house software MODAN using the PolyMAX frequency-domain method [37].

The post-processing of the numerical and experimental results was performed using MATLAB.

The matching of the eigenmodes is based on the modal assurance criterion (MAC) which leads to a correlation matrix between two modal bases whose component values are normalized between 0 and 1, with 1 indicating the modal vectors are colinear and 0 indicating they are orthogonal [38]. Here, we consider that two modes are matched if they present a $MAC > 0.7$.

In order to compare numerical and experimental results, a common variation criterion must be chosen. Given the small populations of results, we opted for a normalized range (NR). For each considered eigenmode, this criterion is defined as follows:

$$NR = \frac{f_{max} - f_{min}}{f_{cv}} \quad (2)$$

with,

$$f_{cv} = \frac{f_{max} + f_{min}}{2} \quad (3)$$

where f_{max} is the maximum eigenfrequency, f_{min} the minimum eigenfrequency and f_{cv} the center eigenfrequency of the studied population.

3 Results

This section presents the numerical and experimental results.

3.1 Numerical results

First, in order to focus only on modes that mainly solicit the facsimile, a criterion based on elastic strain energy is used. The modes of interest will be those for which the strain energy within the facsimile represents more than 80% of the total strain energy. The percentage of total strain energy within the facsimile according to the eigenmodes identified, and the final numbering, are shown in figure 9. As a result, only 11 eigenmodes will be retained for further analysis, compared to 20 initially.

Regarding the impact of the assembly of the soundboard with the instrument body, the correlation of the eigenmodes obtained with the modeling of the C0 and C1 configurations has been carried out. The resulting normalized ranges are presented in table 4. The maximum value is 0.64% for mode 4.

Regarding the impact of the assembly of the table with its brace, the correlation of the eigenmodes obtained with the modeling of the C1 and C2 configurations has been carried out. The resulting normalized ranges are presented in table 4. The maximum value is 0.03% for mode 1.

Regarding the impact of the gluing, the correlation of the eigenmodes obtained with the modeling of the C0, C3, C4-85 and C4-70 configurations was carried out. For the C4-85 modeling, the resulting normalized ranges are presented in table 5. The maximum value is 1.56% for mode 7. For C4-70 modeling, the resulting normalized ranges are presented in table 5. The maximum value is 2.56% for mode 7.

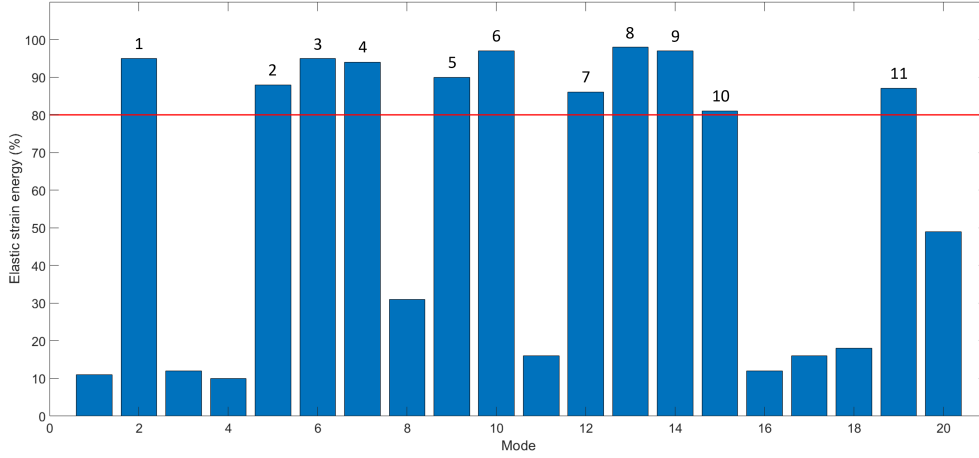

Figure 9: Percentage of total elastic strain energy within the facsimile according to identified eigenmodes and final numbering

Mode	f_{C0} (Hz)	f_{C1} (Hz)	NR (%)	Mode	f_{C1} (Hz)	f_{C2} (Hz)	NR (%)
1	296.95	298.42	0.49	1	298.42	298.52	0.03
2	440.63	442.85	0.50	2	442.85	442.94	0.02
3	447.80	449.96	0.48	3	449.96	449.93	0.01
4	638.87	642.94	0.64	4	642.94	643.08	0.02
5	706.12	705.12	0.14	5	705.12	705.26	0.02
6	742.78	742.59	0.03	6	742.59	742.68	0.01
7	846.79	848.12	0.16	7	848.12	848.10	0.00
8	894.32	895.37	0.12	8	895.37	895.43	0.01
9	941.79	940.60	0.13	9	940.60	940.71	0.01
10	959.37	961.33	0.20	10	961.33	961.42	0.01
11	1134.63	1136.13	0.13	11	1136.13	1136.37	0.02
Mean value			0.27	Mean value			0.02

Table 4: Frequencies and normalized ranges of identified eigenmodes (modeling of C0, C1 and C2 configurations)

Mode	f_{C3} (Hz)	f_{C4-85} (Hz)	NR (%)	Mode	f_{C3} (Hz)	f_{C4-70} (Hz)	NR (%)
1	294.68	291.89	0.95	1	294.68	289.44	1.80
2	437.36	433.19	0.96	2	437.36	429.59	1.79
3	444.46	440.97	0.79	3	444.46	438.91	1.26
4	631.02	622.65	1.34	4	631.02	616.42	2.34
5	702.11	697.08	0.72	5	702.11	693.23	1.27
6	738.13	731.72	0.87	6	738.13	727.01	1.52
7	834.19	821.26	1.56	7	834.19	813.09	2.56
8	888.87	881.86	0.79	8	888.87	879.31	1.08
9	937.75	931.32	0.69	9	937.75	926.92	1.16
10	955.08	948.00	0.74	10	955.08	944.05	1.16
11	1129.10	1121.67	0.66	11	1129.10	1116.58	1.12
Mean value			0.92	Mean value			1.55

Table 5: Frequencies and normalized ranges of identified eigenmodes (modeling of C3, C4-85 and C4-70 configurations)

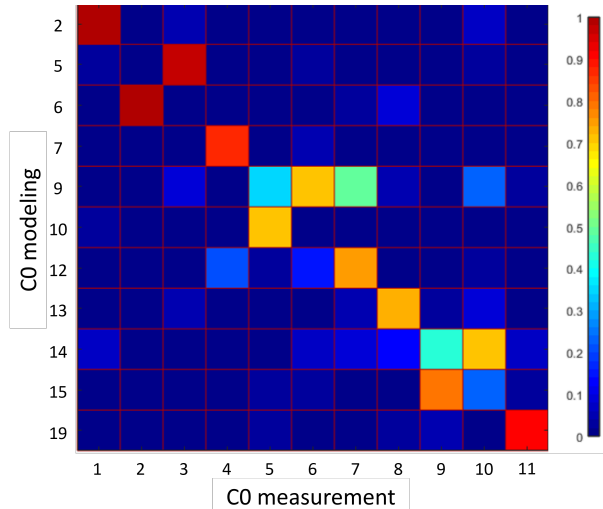

Figure 10: MAC matrix (C0 modeling/C0 measurement)

Mode	f_{cv} (Hz)	$f_{max} - f_{min}$ (Hz)	NR (%)
1	238.60	2.21	0.93
2	401.30	4.49	1.12
3	375.11	3.60	0.96
4	517.03	5.16	1.00
5	637.65	7.65	1.20
6	624.10	4.59	0.74
7	674.52	5.07	0.75
8	771.00	4.39	0.57
9	867.68	5.97	0.69
10	784.22	4.03	0.51
11	1086.79	5.64	0.52
Mean value			0.82

Table 6: Central values, frequency differences and normalized ranges of identified eigenmodes (measurements of C0 configuration)

3.2 Experimental results

For the measurements performed on the C0 configuration, eleven eigenmodes were identified during the modal analysis. In order to compare the numerical and experimental results, the eigenmodes obtained with the modeling of the configuration C0 and those identified from the measurements performed on the configuration C0, were first matched using the modal assurance criterion and the results are shown in figure 10. A change can be observed in the order of the eigenmodes. The numerical mode 2 corresponds to the experimental mode 3 and inversely. The numerical mode 5 corresponds to the experimental mode 6 and inversely. The numerical mode 9 corresponds to the experimental mode 10 and inversely. In the following, the numerical numeration is maintained.

Regarding the repeatability of the measurements during a day, the frequency response functions, averaged over all the measurement points, for the nine measurements performed on the C0 configuration, are shown in figure 11. During the modal analysis, eleven eigenmodes were identified for the measurements performed on the C0 configuration. The resulting normalized ranges of the identified modes have been studied and are presented in table 6. The maximum value is 1.20% for mode 5.

Regarding the impact of the assembly of the soundboard with the instrument body, eleven eigenmodes were identified during the modal analysis of the measurements performed on configuration C1. The matching

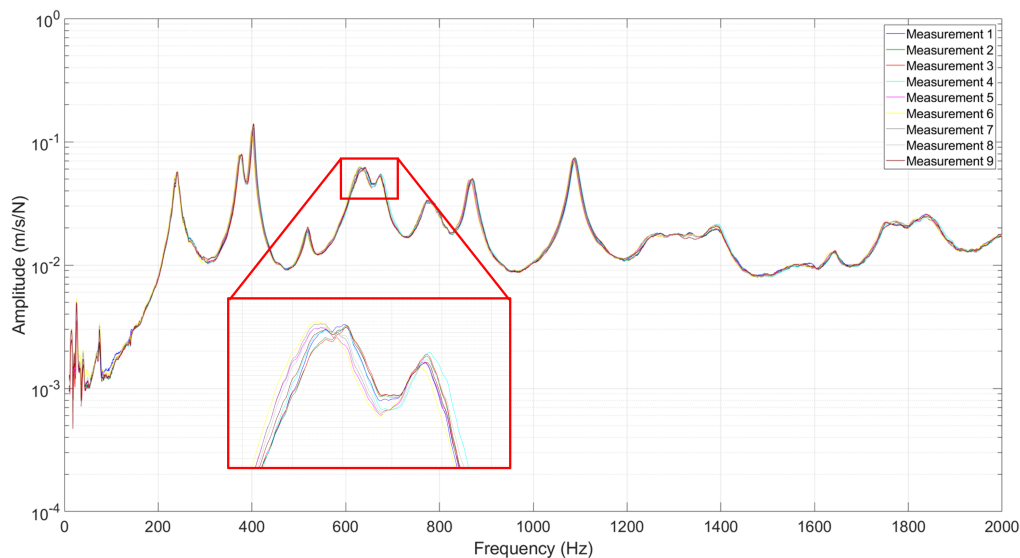

Figure 11: Frequency response functions of the nine measurements performed on configuration C0

of the eigenmodes identified with the measurements performed on configurations C0 and C1 was performed and the resulting normalized ranges of the identified modes were studied and are presented in table 7. The maximum value is 6.36% for mode 4.

Regarding the impact of the assembly of the table with its brace, eight eigenmodes were identified during the modal analysis of the measurements performed on configuration C2. The matching of the eigenmodes identified with the measurements performed on configurations C1 and C2 was performed, and modes 7, 8 and 10 were not identified for the measurements performed on configuration C2. The resulting normalized ranges of the identified modes were studied and are presented in table 8. The maximum value is 3.84% for mode 3.

Regarding the impact of the gluing, eight eigenmodes were identified during the modal analysis of the measurements performed for the 1st and 2nd gluing operations, compared with eleven for the 3rd gluing operation. The matching of the eigenmodes identified with the measurements performed for the different gluing operations was performed and modes 7, 8 and 10 were not identified for the 1st and 2nd gluing operations. The resulting normalized ranges of the identified modes were studied and are presented in table 9. The maximum value is 8.97% for mode 4.

4 Discussion

Firstly, in figure 12, a comparison of the numerically and experimentally obtained eigenfrequencies for the C0 configuration is presented. Whatever the eigenmode, one can observe that the numerical results are higher than the experimental ones. One way of minimizing this difference would be to calibrate the model by identifying the material parameters of the wood species used during the making of the facsimile. However, as previously stated, the purpose of this study is to evaluate the capacity of the unvalidated numerical model to predict trends.

Figure 13 presents a comparison of the normalized ranges obtained numerically and a comparison of the mean value of these normalized ranges. The assembly steps are seen to have a very low impact on the studied eigenfrequencies. Moreover, the assembly of the soundboard with the body of the instrument is seen to have a higher impact on the eigenfrequencies than that induced by the assembly of the table with its brace. However, whatever the mode, the gluing appears to have the predominant impact compared to the assembly steps. The gluing has the strongest impact on the 7th and 4th mode.

Figure 14 presents a comparison of the normalized ranges obtained experimentally and a comparison of

Mode	f_{cv} (Hz)	$f_{max} - f_{min}$ (Hz)	NR (%)
1	239.91	3.61	1.50
2	399.64	3.79	0.95
3	369.61	3.03	0.82
4	527.03	33.51	6.36
5	641.29	19.24	3.00
6	620.58	3.79	0.61
7	680.58	19.42	2.85
8	773.86	10.02	1.29
9	867.65	7.59	0.87
10	783.54	9.29	1.19
11	1086.35	10.26	0.94
Mean value			1.85

Table 7: Central values, frequency differences and normalized ranges of identified eigenmodes (measurements of C0 and C1 configurations)

Mode	f_{cv} (Hz)	$f_{max} - f_{min}$ (Hz)	NR (%)
1	236.01	5.12	2.17
2	401.18	7.00	1.74
3	364.22	13.99	3.84
4	549.00	9.95	1.81
5	649.44	3.80	0.59
6	627.39	14.93	2.38
7	-	-	-
8	-	-	-
9	870.27	9.82	1.13
10	-	-	-
11	1097.59	21.76	1.98
Mean value			1.96

Table 8: Central values, frequency differences and normalized ranges of identified eigenmodes (measurements of C1 and C2 configurations)

Mode	f_{cv} (Hz)	$f_{max} - f_{min}$ (Hz)	NR (%)
1	241.12	7.26	3.01
2	404.00	9.90	2.45
3	379.79	12.96	3.41
4	538.61	48.31	8.97
5	648.90	30.16	4.65
6	632.96	22.32	3.53
7	-	-	-
8	-	-	-
9	871.30	13.22	1.52
10	-	-	-
11	1099.76	31.58	2.87
Mean value			3.80

Table 9: Central values, frequency differences and normalized ranges of identified eigenmodes (gluing)

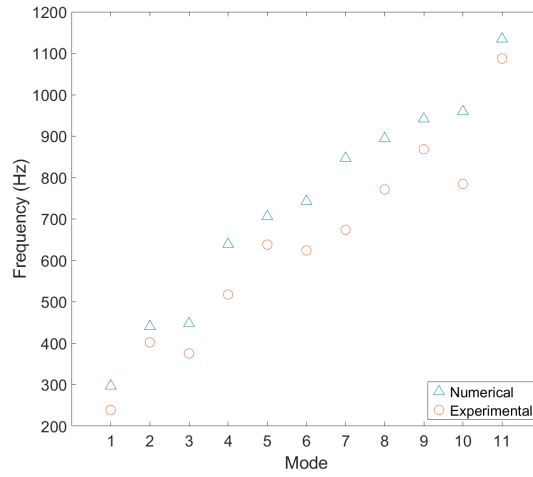

Figure 12: Comparison of numerical and experimental eigenfrequencies for the C0 configuration

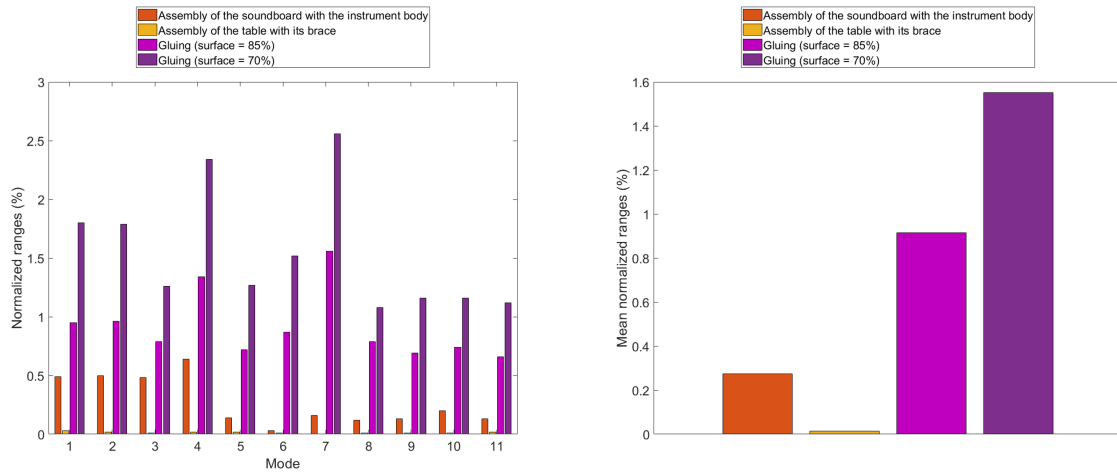

Figure 13: Comparison of normalized ranges and mean value of normalized ranges for each eigenmode obtained numerically

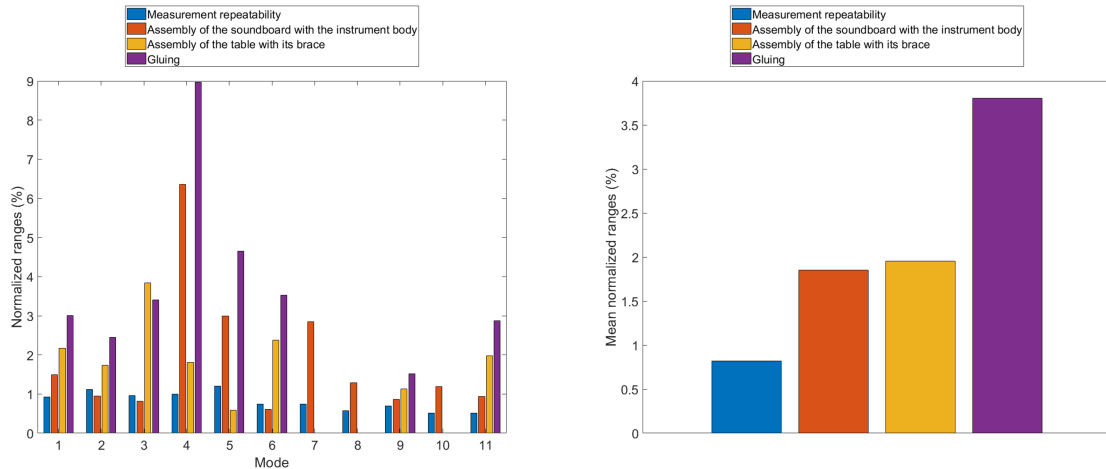

Figure 14: Comparison of normalized ranges and mean value of normalized ranges for each eigenmode obtained experimentally

the mean value of these normalized ranges. The variability specific to the study on the repeatability of the measurements is seen to be the lowest. Furthermore, we can observe that the gluing has a greater overall impact than that induced by the assembly steps. Also, although no information are known about the 7th mode, the 4th mode is still observed as the most impacted eigenmode. Finally, it should be noted that the study of the soundboard assembly process requires its gluing and ungluing from the MDF block. The gluing has been seen to have a significant impact on the eigenfrequencies of interest and are no doubt responsible for the differences we have observed on the low frequency soundboard behavior. This impact is smaller, since more than two measurements were taken during the gluing study. Thus, this result tends to show that the assembly steps have a very low impact on the soundboard’s low-frequency vibratory behavior.

Despite the difference between numerical and experimental results, all these similar observations illustrate the capacity of the unvalidated numerical models to provide useful predictive trends in a museum context and to prevent the realization of costly experimental campaigns, in terms of time or equipment, that would not give significant results. Furthermore, these results tend to demonstrate that, for this instrument, the assembly steps have a low impact on the low-frequency vibratory behavior of the soundboard, which was not intuitive. Thus, the curator can assume that it will not be necessary to reintroduce the internal stresses induced by the assembly process, given these results.

5 Conclusion

Object of use as much as object of art, the musical instrument undergoes multiple transformations throughout its life. Its material history and its structural transformations are rarely well understood. The analysis of the state of conservation and the history of restoration confirm that the disassembly of soundboards has been a common practice since at least the beginning of the 19th century.

A variety of factors influence the mechanical state of wooden stringed musical instruments. A distinction is made between the mechanical state induced by string tension under normal playing conditions and the one induced by the instrument maker during the instrument assembly process. The work presented here focuses on the impact of the initial mechanical state induced by a particular assembly method on the low-frequency vibratory behavior of a real wooden soundboard. This study had the double objective of evaluating the impact of the assembly process on the low-frequency vibratory behavior of the soundboard, and also of assessing the ability of an unvalidated numerical model to predict trends that may be useful for decision support in a museum context. This work has led to numerical and experimental studies carried out on a facsimile of Christoph Koch’s archlute soundboard of 1654. The numerical study, performed with an unvalidated model, demonstrated a greater impact of the gluing on the vibratory behavior of the soundboard than its assembly

steps. The experimental campaign validated this trend, although the experimentally observed impact is higher than the one observed numerically. Thus, this study highlighted two observations: the capacity of an unvalidated model to predict useful trends in a museum context, and the higher impact of the gluing compared to that induced by the assembly process on the low frequency behavior of the soundboard. It should be borne in mind that this study was carried out on a facsimile. In the context of historic heritage instruments, all the constraints specific to the latter must be taken into account, i.e. the use of global, non-intrusive methodological approaches. In addition, the history, material properties and current mechanical state of the instrument will be uncertain. Ageing and visible and non-visible damage will also have to be taken into account. So, in this context, uncertainties will be numerous, severe and difficult to quantify. These factors led us to carry out a study based on an unvalidated model.

In order to validate the transfer of these observations to an entire instrument, the same experimental campaign should be carried out on a facsimile of the complete Christoph Koch archlute. Moreover, due to the unique aspect of each instrument, the methodology implemented here could be applied to other types of instruments using different assembly methods than those studied.

Acknowledgments We thank the Fondation des Sciences du Patrimoine and the Domaine d’Intérêt Majeur (DIM) Matériaux anciens et patrimoniaux for their generous support of this research project. We also thank Joël Dugot for his help in fabricating the facsimile of the soundboard.

References

- [1] Andrej Štafura, Peter Barta, Ján Haluška, Martin Čulík, Janka Petőczová, and Stefan Nagy. *Historické organové pozitívy na Slovensku: Historical positive organs within the territory of Slovakia*. December 2022.
- [2] D. Friederich. Les tables des guitares classiques et leurs barrages. In *Acoustique et instruments anciens: factures, musique et science*, page 20, Paris, 1998.
- [3] J. Colmars, S. Leconte, M. Vion, C. Clarke, and E. Marconi. Précontraintes de fabrication dans les tables d’harmonie d’instruments de musique en bois. In *Sciences des matériaux du patrimoine culturel*, volume 2, page 4, Paris, 2012.
- [4] R. Jones and C. Wykes. *Holographic and speckle interferometry*. Number 6. Cambridge university press, 1989.
- [5] P. Castellini, M. Martarelli, and E. P. Tomasini. Laser Doppler Vibrometry: Development of advanced solutions answering to technology’s needs. *Mechanical systems and signal processing*, 20(6):1265–1285, 2006.
- [6] R. Viala. *Towards a model-based decision support tool for stringed musical instruments making*. PhD Thesis, Université Bourgogne Franche-Comté, 2018.
- [7] E. Bakarezos, Y. Orphanos, E. Kaselouris, V. Dimitriou, M. Tatarakis, and N. Papadogiannis. Laser-based interferometric techniques for the study of musical instruments. In *Computational Phonogram Archiving*, pages 251–268. Springer, 2019.
- [8] S. Le Moyne, S. Le Conte, and F. Ollivier. Couchet harpsichord soundboard vibroacoustics behaviour: An application of the impact nearfield acoustical holography (IPNAH). *Journal of the Acoustical Society of America*, 123(5):3445–3445, 2008.
- [9] Sylvie Le Moyne, Sandie Le Conte, François Ollivier, Joël Frelat, Jean-Claude Battault, and Stéphane Vaiedelich. Restoration of a 17th-century harpsichord to playable condition: A numerical and experimental study. *The Journal of the Acoustical Society of America*, 131(1):888–896, January 2012.
- [10] J. Woodhouse. On the “bridge hill” of the violin. *Acta acustica united with acustica*, 91(1):155–165, 2005.

- [11] F. Ablitzer, J.-P. Dalmont, and N. Dauchez. Static model of a violin bow: Influence of camber and hair tension on mechanical behavior. *The Journal of the Acoustical Society of America*, 131(1):773–782, 2012.
- [12] Delphine Chadefaux, Jean-Loïc Le Carrou, and Benoît Fabre. A model of harp plucking. *The Journal of the Acoustical Society of America*, 133(4):2444–2455, 2013. Publisher: AIP Publishing.
- [13] B. Trévisan, K. Ege, and B. Laulagnet. Vibroacoustics of orthotropic plates ribbed in both directions: Application to stiffened rectangular wood panels. *The Journal of the Acoustical Society of America*, 139(1):227–246, 2016.
- [14] B. Trévisan, K. Ege, and B. Laulagnet. Vibroacoustic Modelling of Piano Soundboards through Analytical Approaches in Frequency and Time Domains. In *Model Validation and Uncertainty Quantification*, volume 3, pages 77–80. Springer, 2017.
- [15] Daniel Konopka, Clemens Gebhardt, and Michael Kaliske. Numerical modelling of wooden structures. *Journal of Cultural Heritage*, 27:S93–S102, October 2017.
- [16] E. Kaselouris, M. Bakarezos, M. Tatarakis, N. Papadogiannis, and V. Dimitriou. A Review of Finite Element Studies in String Musical Instruments. *Acoustics*, 4(1):183–202, 2022.
- [17] V. Välimäki, J. Pakarinen, C. Erkut, and M. Karjalainen. Discrete-time modelling of musical instruments. *Reports on progress in physics*, 69(1):1, 2005.
- [18] S. Bilbao. *Numerical sound synthesis: finite difference schemes and simulation in musical acoustics*. John Wiley & Sons, 2009.
- [19] B. Richardson. Numerical modelling of stringed musical instruments. In *SMAC*, volume 93, pages 457–462, Sweden, 1993.
- [20] A. Le Pichon. *Méthode de prediction du rayonnement acoustique de structures volumiques. Composees d'une ou plusieurs faces planes vibrantes. Application aux instruments de musique a cordes*. PhD Thesis, Université Paris 11, 1996.
- [21] M. Moosrainer and H. Fleischer. Application of BEM and FEM to musical instruments. *Estorff, O. v.(Hrsg.), Boundary Elements in Acoustics-Advances and Applications, WIT Press, Southampton/Boston 2000, 377, 410, 2000*.
- [22] C. Gough. Vibrational modes of the violin family. *Proc. SMAC2013*, pages 66–74, 2013.
- [23] K. K. Raju and G. V. Rao. Free vibration behavior of prestressed beams. *Journal of Structural Engineering*, 112(2):433–437, 1986.
- [24] D. Addessi, W. Lacarbonara, and A. Paolone. On the linear normal modes of planar pre-stressed curved beams. *Journal of Sound and Vibration*, 284(3-5):1075–1097, 2005.
- [25] A. Mamou-Mani. *Précontraintes et vibration des tables d'harmonie: vers une modélisation du savoir-faire des fabricants d'instruments de musique*. PhD Thesis, Université Paris 6, 2007.
- [26] S. Vaiedelich, C. Laloue, J. Frelat, and J.-C. Battault. Maintenir en état de jeu: le cas du clavecin de I. Couchet, Anvers 1652. *Technè: la science au service de l'histoire de l'art et des civilisations*, 25:74–78, 2007.
- [27] S. Le Conte, S. Le Moyne, F. Ollivier, and S. Vaiedelich. Using mechanical modelling and experimentation for the conservation of musical instruments. *Journal of Cultural Heritage*, 13(3):S161–S164, 2012.
- [28] A. Mamou-Mani, J. Frelat, and C. Besnainou. Numerical simulation of a piano soundboard under downbearing. *The Journal of the Acoustical Society of America*, 123(4):2401–2406, 2008.

- [29] A. Mamou-Mani, S. Le Moyne, F. Ollivier, C. Besnainou, and J. Frelat. Prestress effects on the eigenfrequencies of the soundboards: Experimental results on a simplified string instrument. *The Journal of the Acoustical Society of America*, 131(1):872–877, 2012.
- [30] American Society of Mechanical Engineers. *Guide for verification and validation in computational solid mechanics*. ASME, 2006.
- [31] W. L. Oberkampf and C. J. Roy. *Verification and Validation in Scientific Computing*. Cambridge University Press, Cambridge, 2010.
- [32] R. Viala, V. Placet, S. Cogan, and E. Foltête. Model-Based Effects Screening of Stringed Instruments. In *Model Validation and Uncertainty Quantification*, volume 3, pages 151–157. Springer International Publishing, Cham, 2016.
- [33] Romain Viala, Marco A Pérez, Vincent Placet, Antonio Manjon, Emmanuel Foltête, and Scott Cogan. Towards model-based approaches for musical instruments making: validation of the model of a Spanish guitar soundboard and characterization features proposal. *Applied Acoustics*, 172:107591, 2021. Publisher: Elsevier.
- [34] D. Guitard. *Mécanique du matériau bois et composites*. Cépaduès, 1987.
- [35] R. Kurt. Effect of glue line thickness on shear strength of wood-to-wood joints. *Wood Res*, 51(1):59–66, 2006.
- [36] A. Melià-Angulo, L. Fuster-López, and A. V. Escuder. Study of the mechanical properties of selected animal glues and their implication when designing conservation strategies. In *CeROArt. Conservation, exposition, Restauration d’Objets d’Art*, volume HS. Association CeROArt asbl, 2017.
- [37] Bart Peeters, Herman Van der Auweraer, Patrick Guillaume, and Jan Leuridan. The PolyMAX frequency-domain method: a new standard for modal parameter estimation? *Shock and Vibration*, 11(3, 4):395–409, 2004. Publisher: IOS Press.
- [38] R. J. Allemang and D. L. Brown. A correlation coefficient for modal vector analysis. In *Proceedings of the 1st International Modal Analysis Conference (IMAC I)*, pages 110–116, Orlando, 1982.