



| PSL  | PERSEE

The Climate Change Impact on Power Grid Transmission Capacity

Sergio Montaña

Thesis supervisor: Dr. Andrea Michiorri

Start date: 01.12.2022

Reporters : Dr. Sandrine Berthon-Fabry
Dr. Sussana Mocci

Sergio Montaña | 04/07/2024

OUTLINE

1. Introduction and Context
2. Methodology
3. Results
4. Discussion

1. Introduction and Context

CONTEXT: CLIMATE-DRIVEN FUTURE ON POWER SYSTEMS

2019-06-01T00

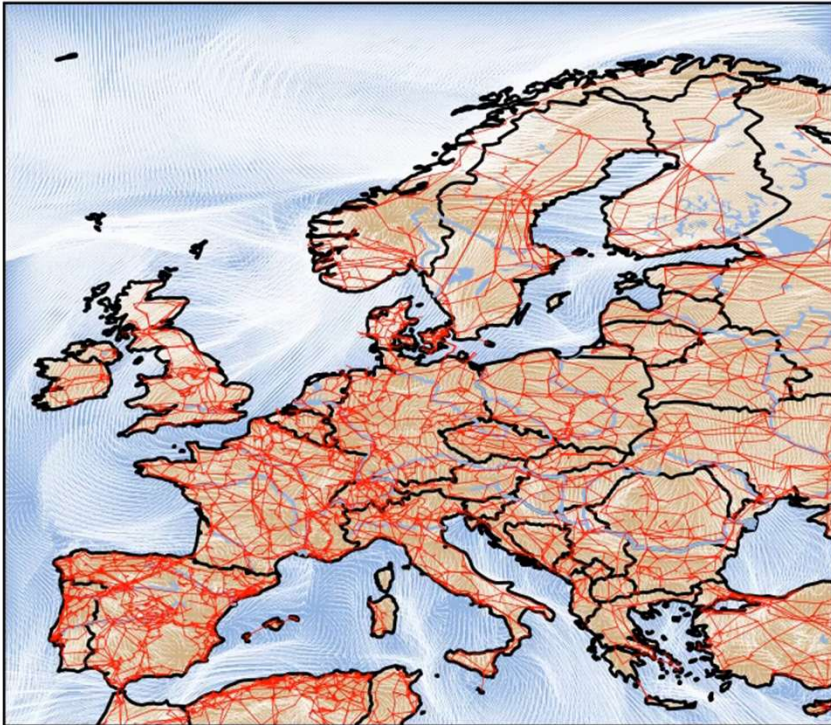

Weather - Driven energy systems – Pr. Pierre Pinson

CONTEXT: CLIMATE-DRIVEN FUTURE ON POWER SYSTEMS

2019-06-01T00

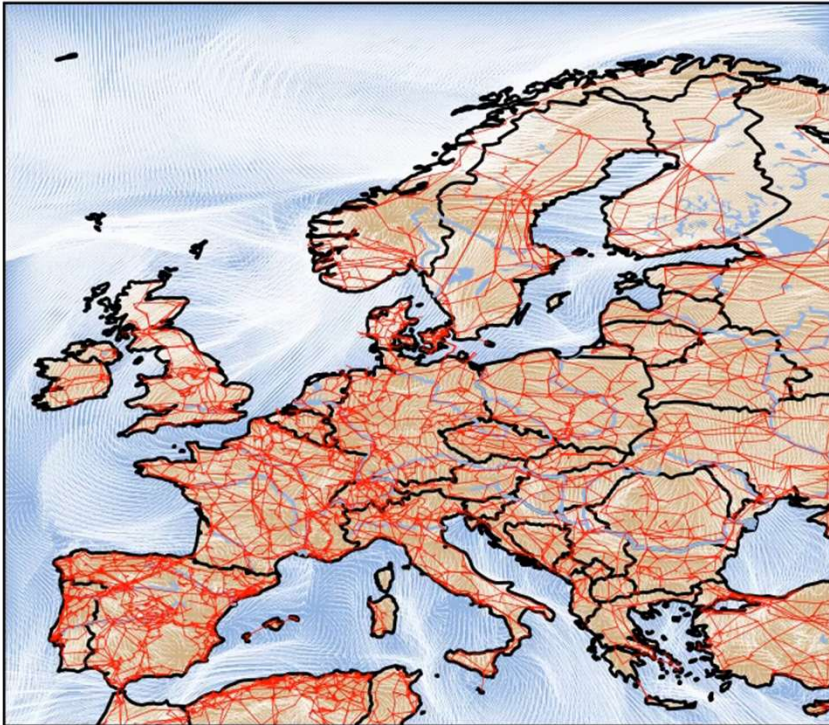

Weather - Driven energy systems – Pr. Pierre Pinson



Regarding overhead lines (OHL) transmission capacity, a study relative to the United States suggests a decline in the range between 1.9% and 5.8%.

INTRODUCTION: THERMAL RATINGS

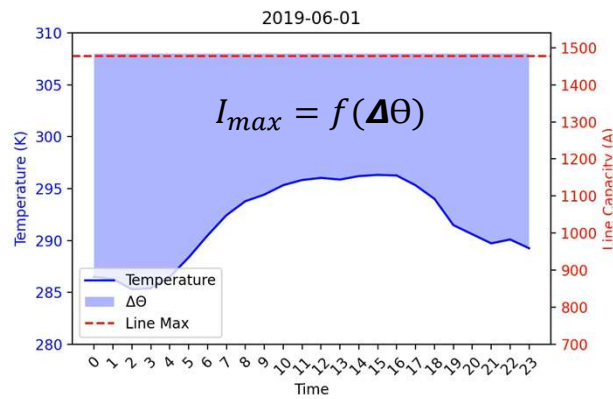
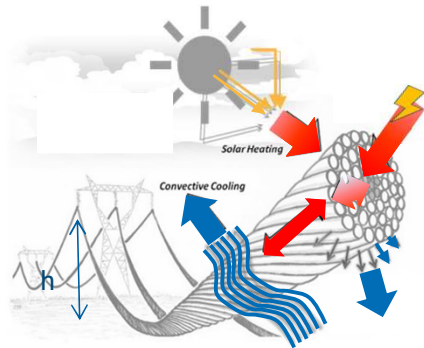

INTRODUCTION: THERMAL RATINGS

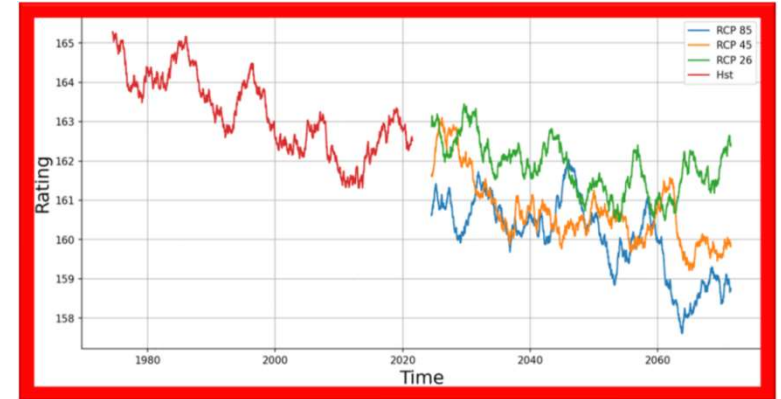
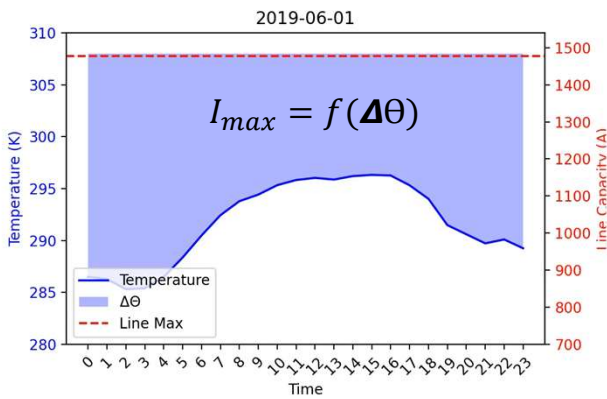
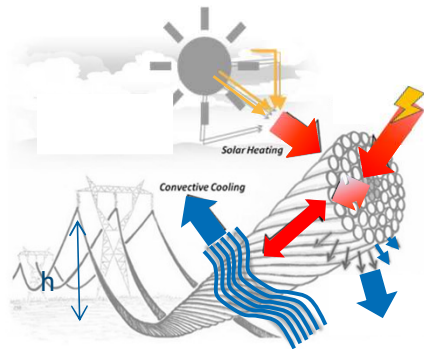

DTR climate change projections for the IT-Lazio Region for a PT, evaluated rolling mean for 2.6, 4.5, 8.5 representative concentration pathways

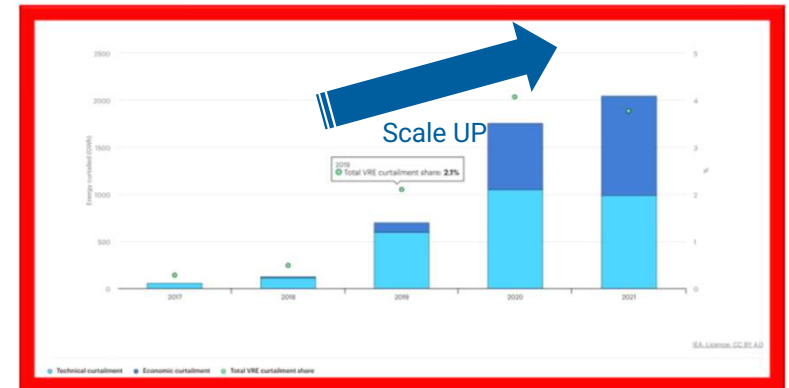

INTRODUCTION: DYNAMIC THERMAL RATING

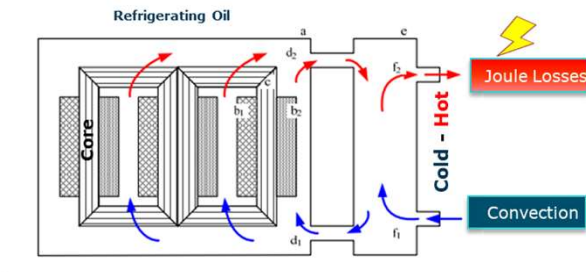

- | | | | |
|-------------------------------|-----------------------|-------------------------------|---------------------------------|
| a | Oil tank | d ₁ d ₂ | Coolant oil flow (cold, hot) |
| b ₁ b ₂ | Windings (+) | e | Heat exchanger |
| c | Ferromagnetic circuit | f ₁ f ₂ | Refrigerating fluid (cold, hot) |

Thermal Model

A. Michiorri, "Power system real-time thermal rating".

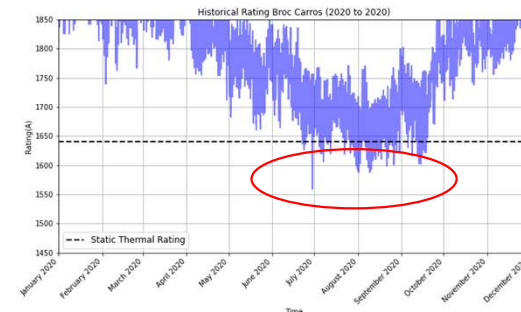

$$I_{DTR}(V_w, \phi_w, \theta_a, H) \forall t \in [1, 2 \dots 24]$$

INTRODUCTION: DYNAMIC THERMAL RATING

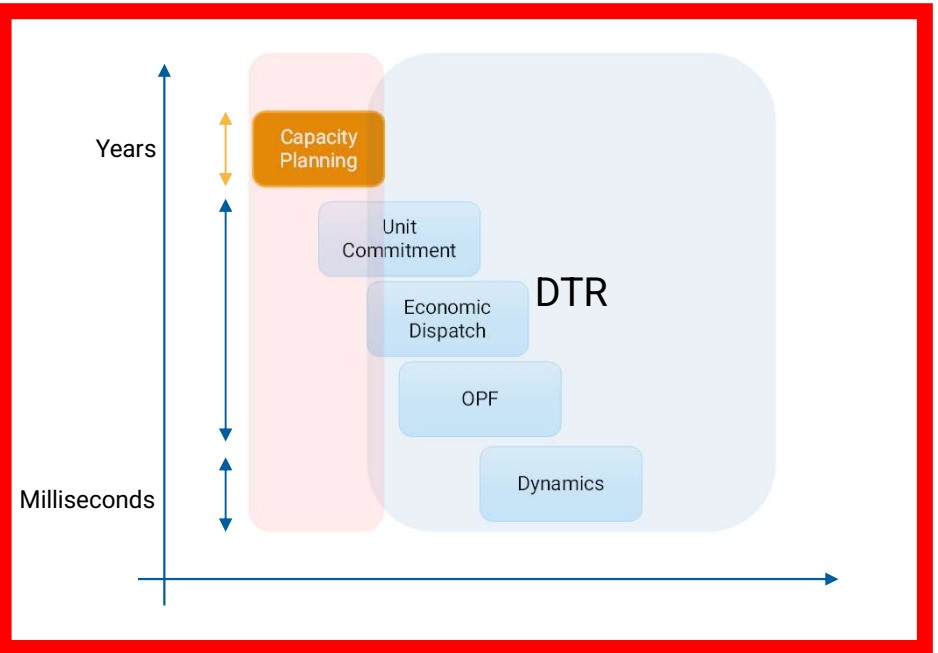

[10] [13] [12] [14,15,16,17,18] [13,11,16]
[19, 23, 24][22] [19, 20] [21]

INTRODUCTION: DYNAMIC THERMAL RATING

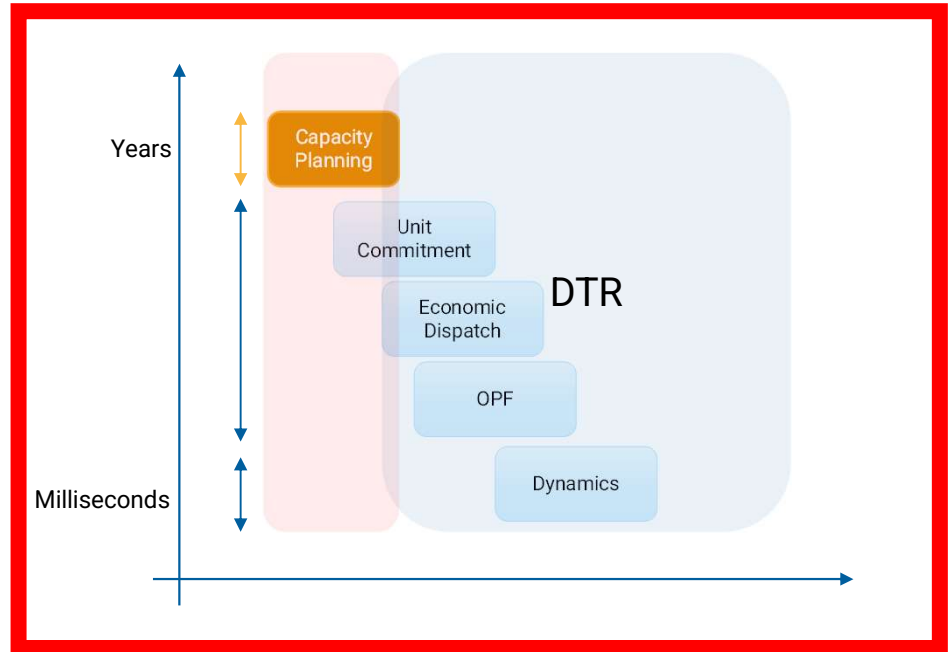

[10] [13] [12] [14,15,16,17,18] [13,11,16]
[19, 23, 24][22] [19, 20] [21]

How to use and exploit the Dynamic thermal ratings considering climate projections in power system planning?

2. Objectives

OBJECTIVES

Objective Power System Planning (PSP) with Dynamic Thermal Rating (DTR).

Q1: How to estimate the DTR resource?

- Thermal Models
- Historical reanalysis
- Future Projections

Q2: How can the DTR be included in PSP?

- Future and Scenario reduction
- Develop Optimization problem G&TEP

Q3: How to integrate Climate Change into PSP?

- Scenarios Simulation

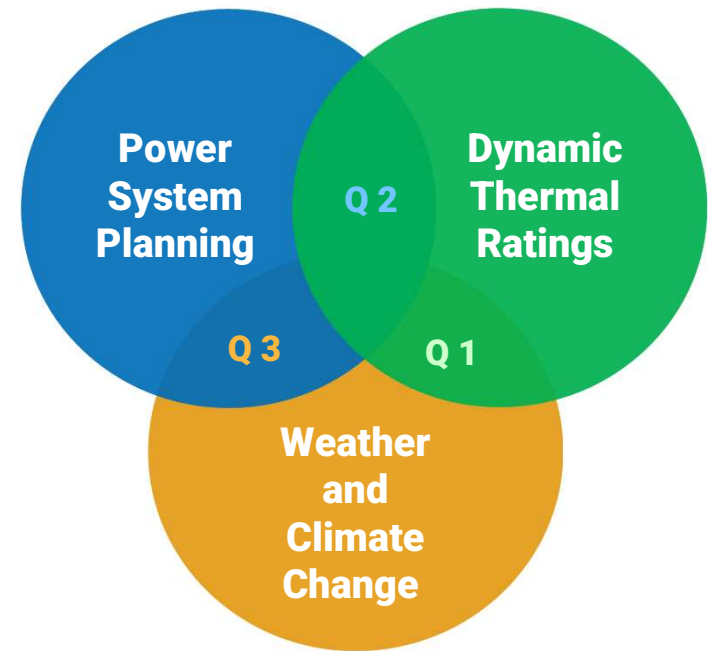

CONTRIBUTIONS

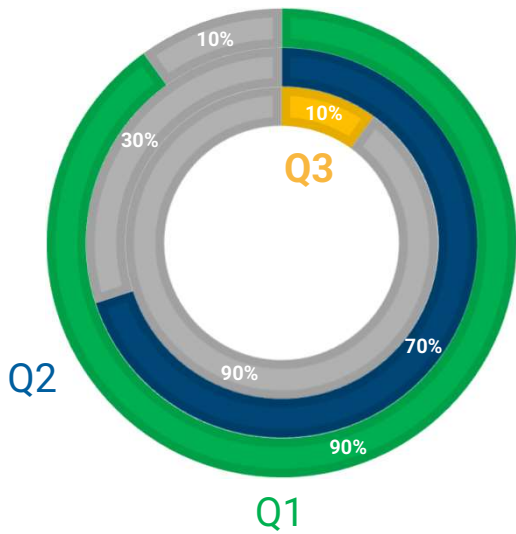

Develop thermal ratings for PSC based on climatic factors.

Enhanced Transmission Capacity Probabilistic Dynamic Rating

Included the Dynamic Thermal limit in a deterministic - GTEP

The influence of Climate Change on Transmission Capacity Methodology (deterministic) is quantified

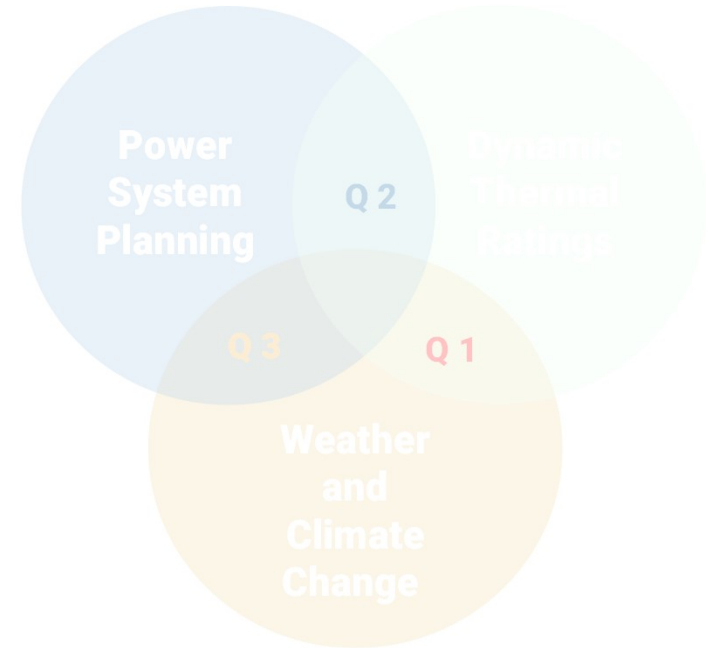

A sample of this is available for the review period, before being uploaded to a more suitable platform, at the address: <https://minesparis-psl.hal.science/hal-04453957v1>

4. Methodology

METHODS

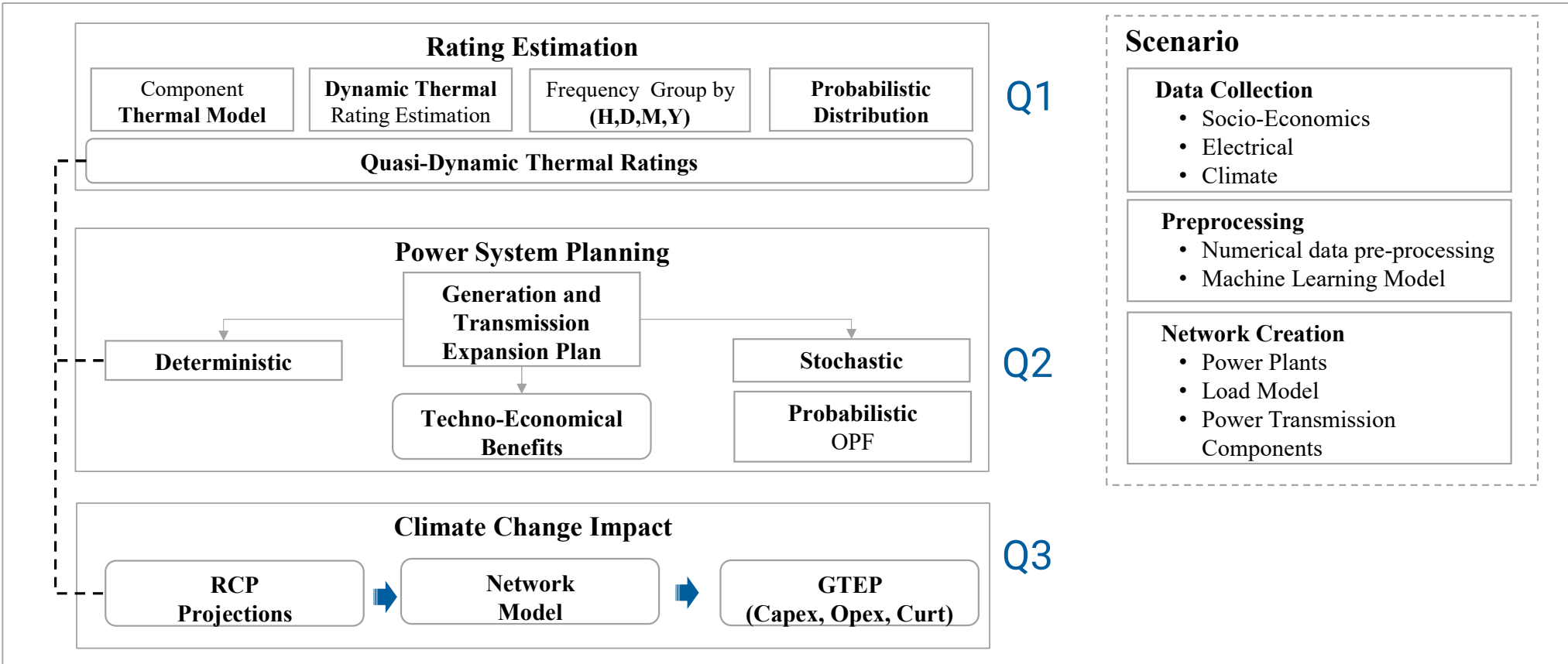

METHODS Q1 : THERMAL MODELS UGC

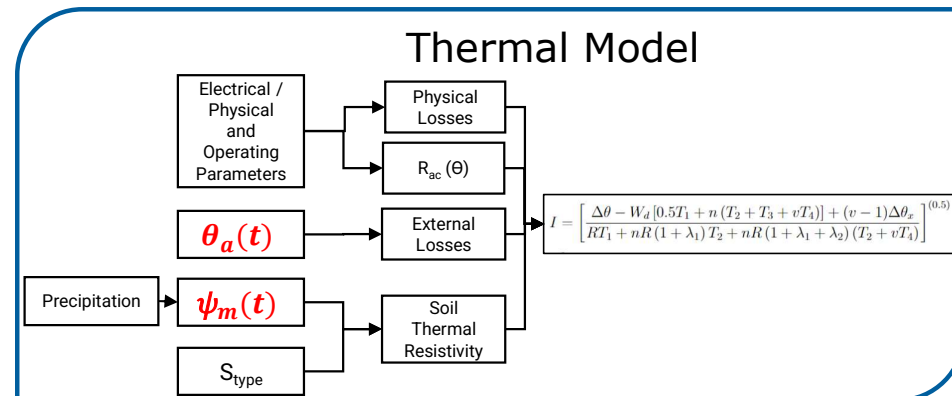
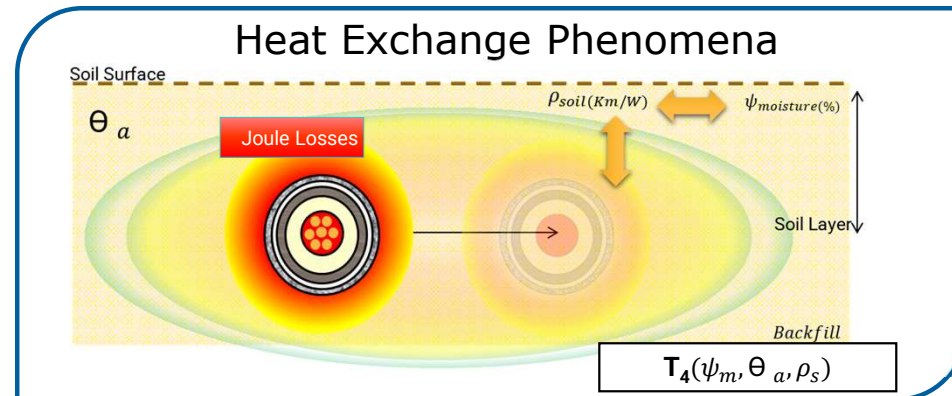
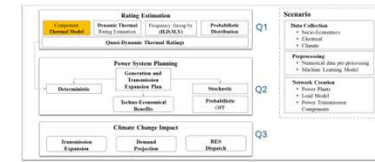

METHODS Q1 : THERMAL MODELS PT

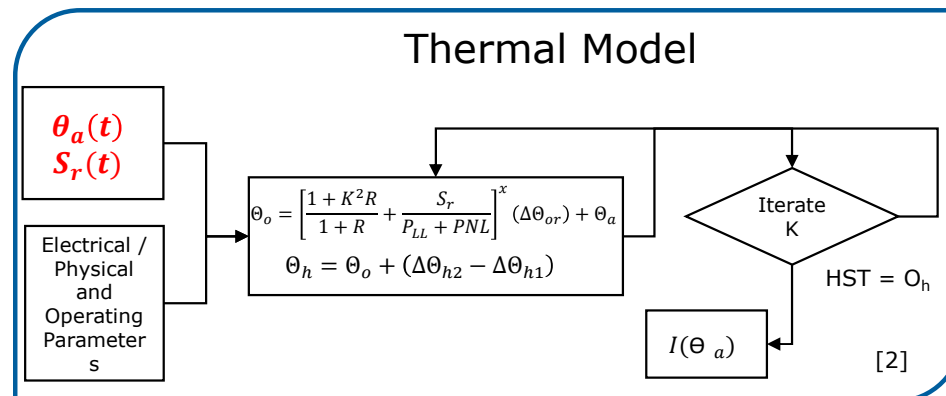
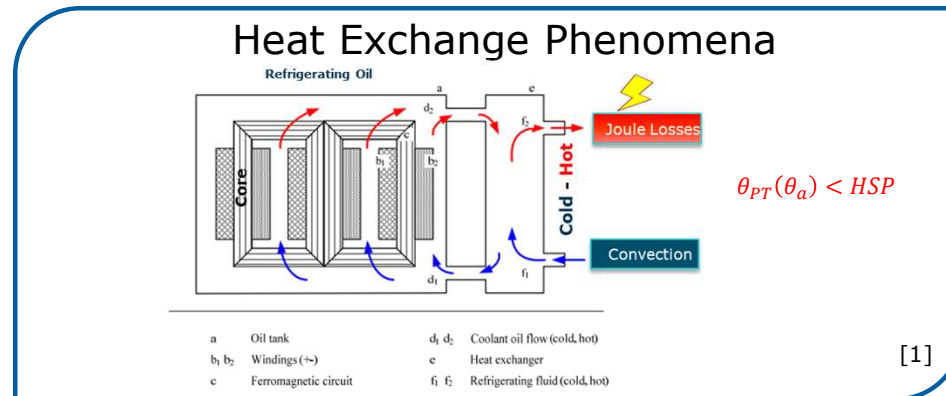
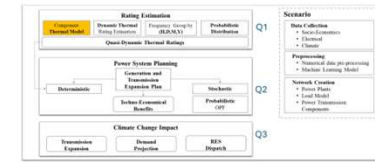

METHODS Q1 : THERMAL MODELS OHL

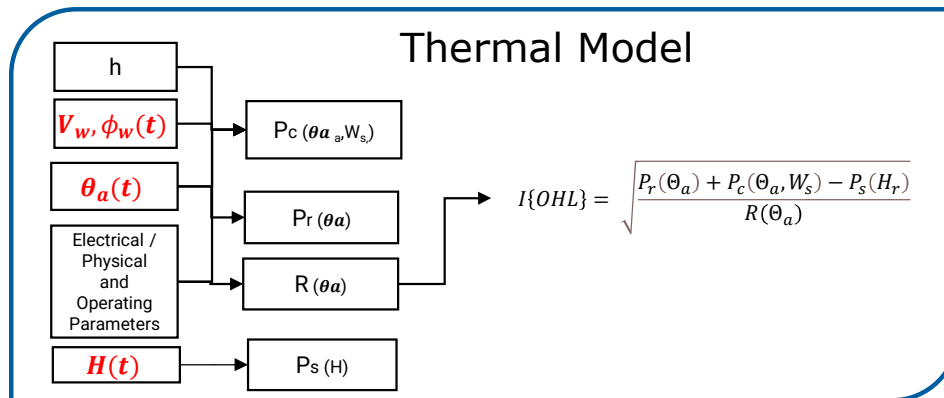
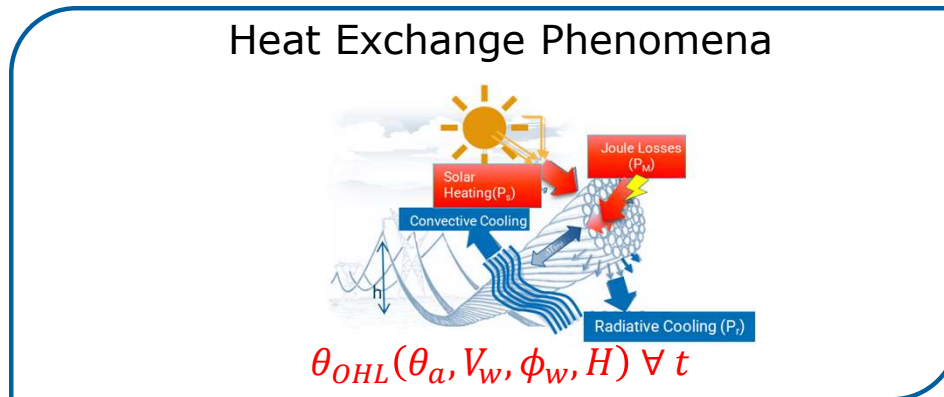
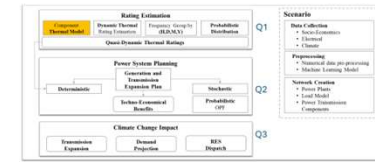

[1] CIGRE. Standard cigre wg 22.12 - the thermal behaviour of overhead conductors. CIGRE, 144:107-105, 2014

METHODS Q1 : DYNAMIC THERMAL RATING

HISTORICAL DYNAMIC RATING

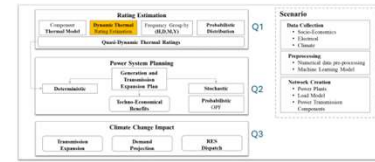
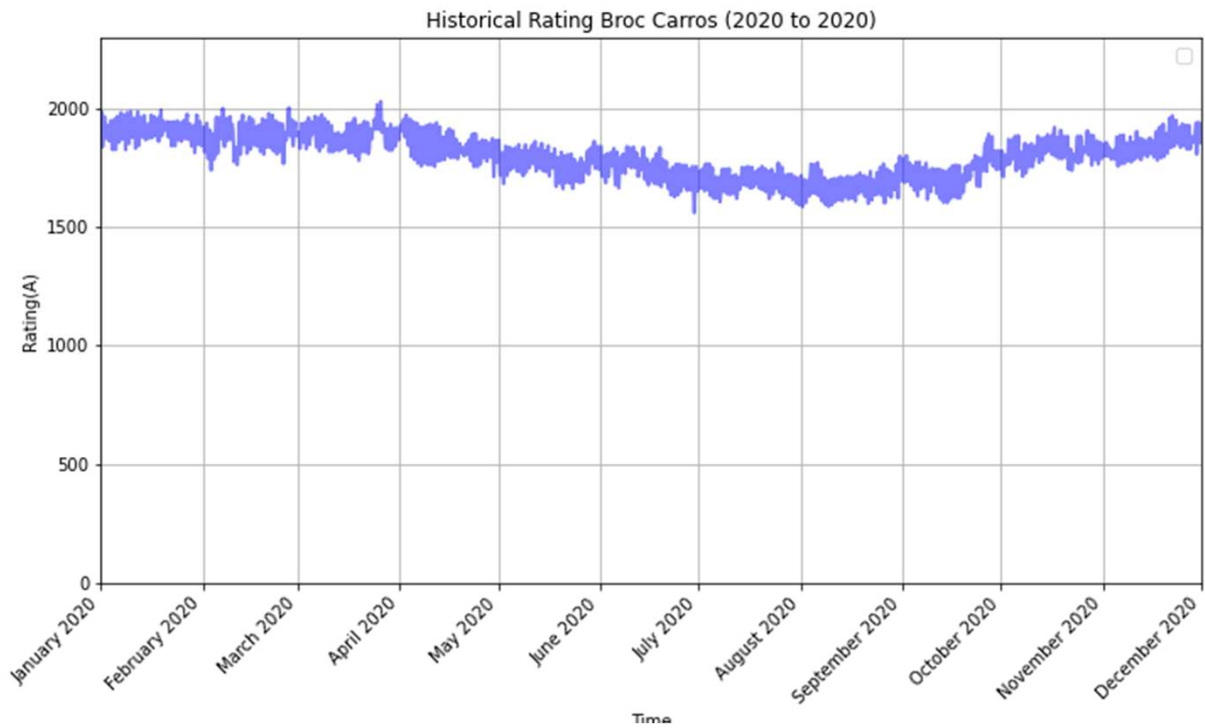

METHODS Q1 : DYNAMIC THERMAL RATING

HISTORICAL DYNAMIC RATING

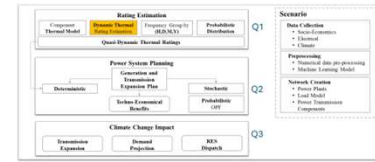
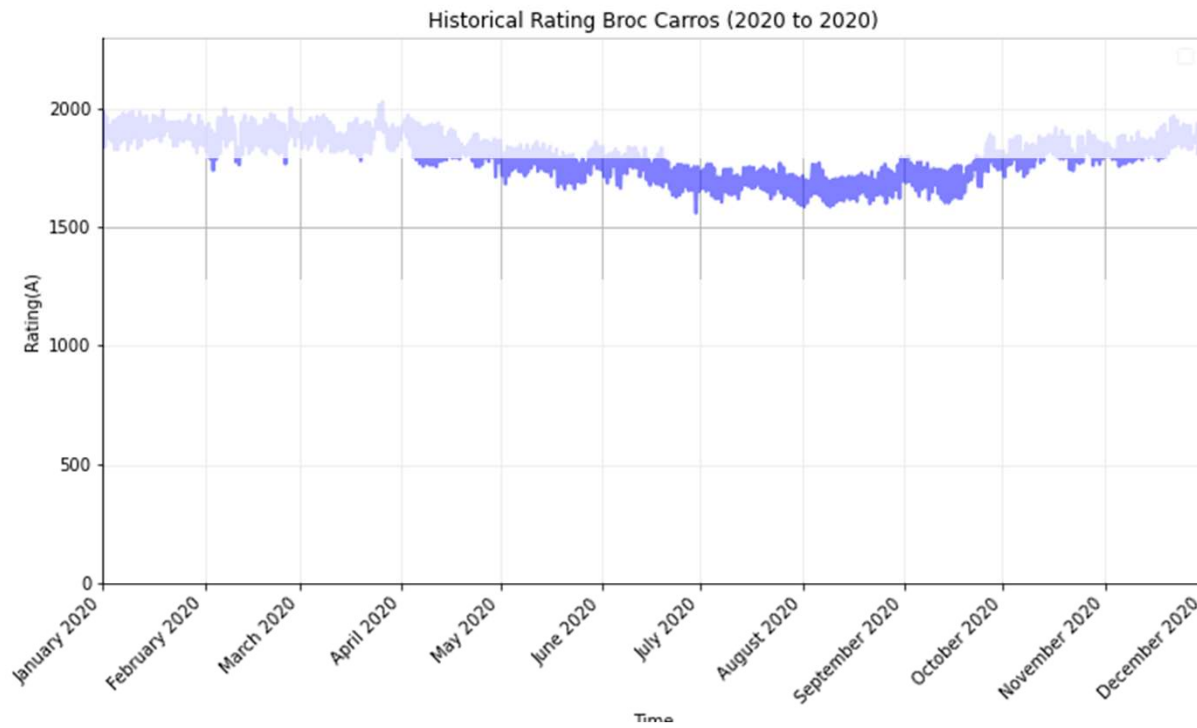

METHODS Q1 : QUASI - DTR

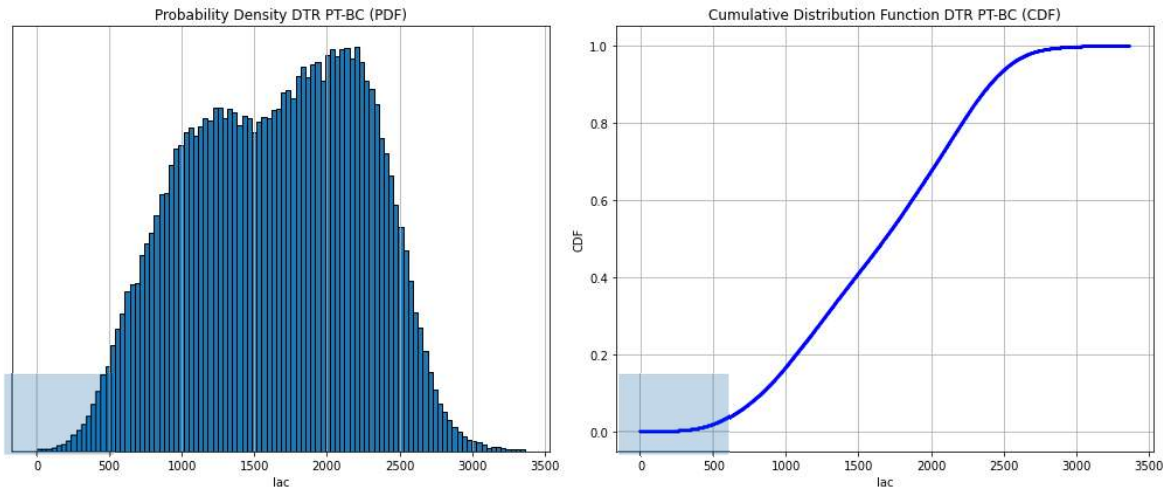
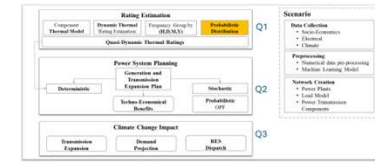

FUTURE / HISTORICAL RATING CALCULATION

METHODS Q1 : QUASI - DTR

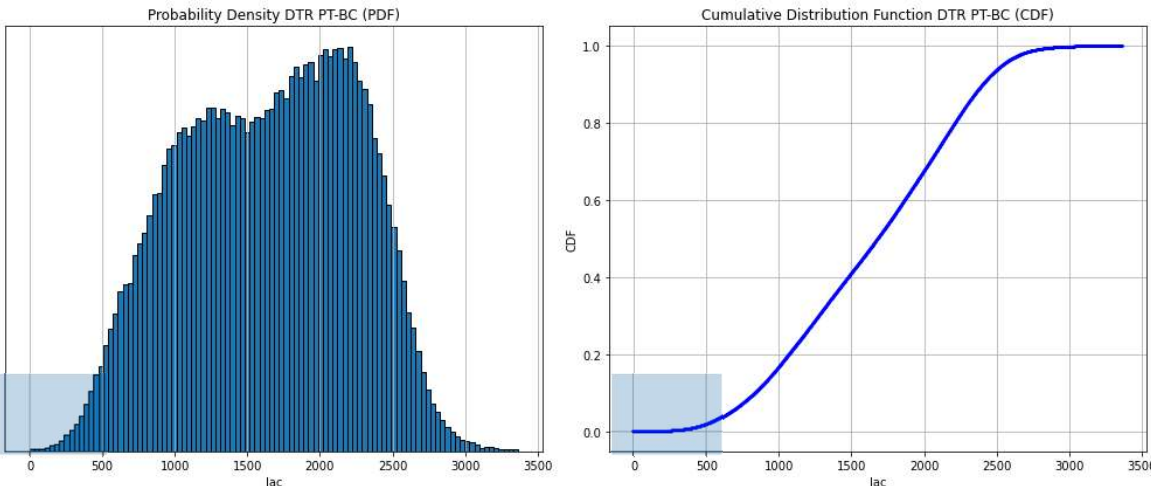
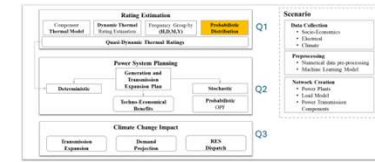

$f(I) = Ix^\alpha$

**FUTURE / HISTORICAL RATING
CALCULATION**

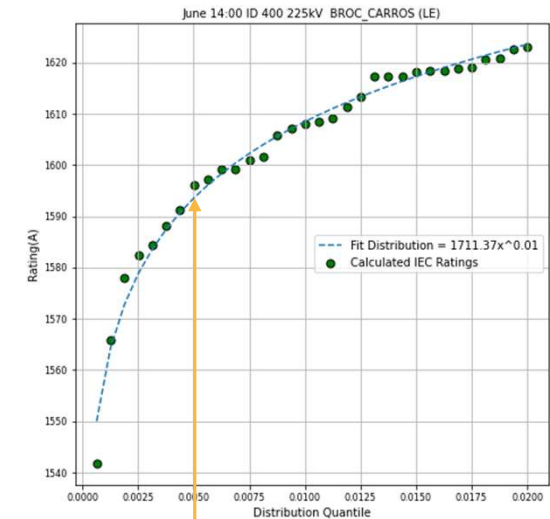

**Exceedance
Risk Value**

METHODS Q1 : QUASI - DTR

qDTR

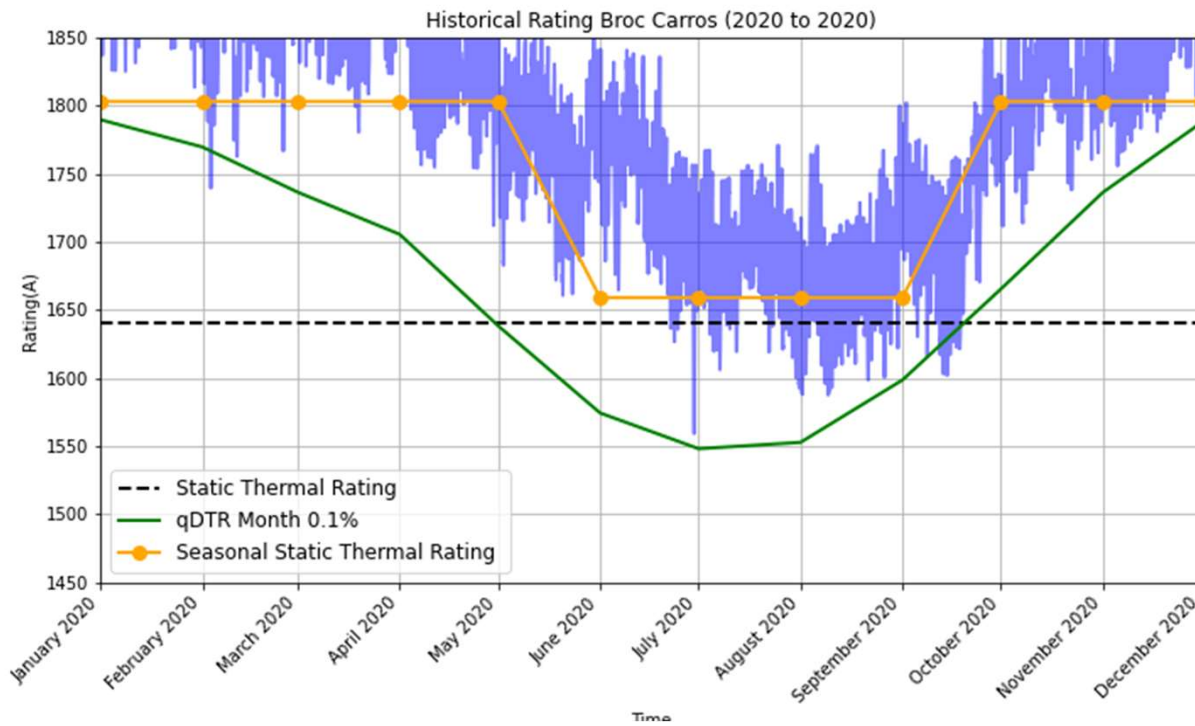

qSeasonally Static Thermal Rating

qStatic Thermal Rating

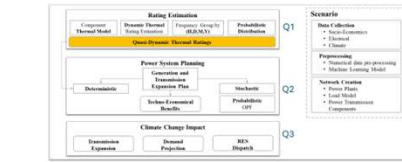

qDTR Monthly [0.1%] Per Power System Component

METHODS Q1 : QUASI - DTR

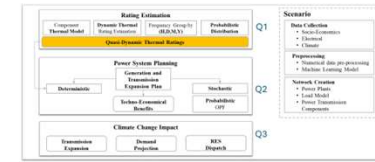

qDTR

Seasonally Static Thermal Rating

Static Thermal Rating

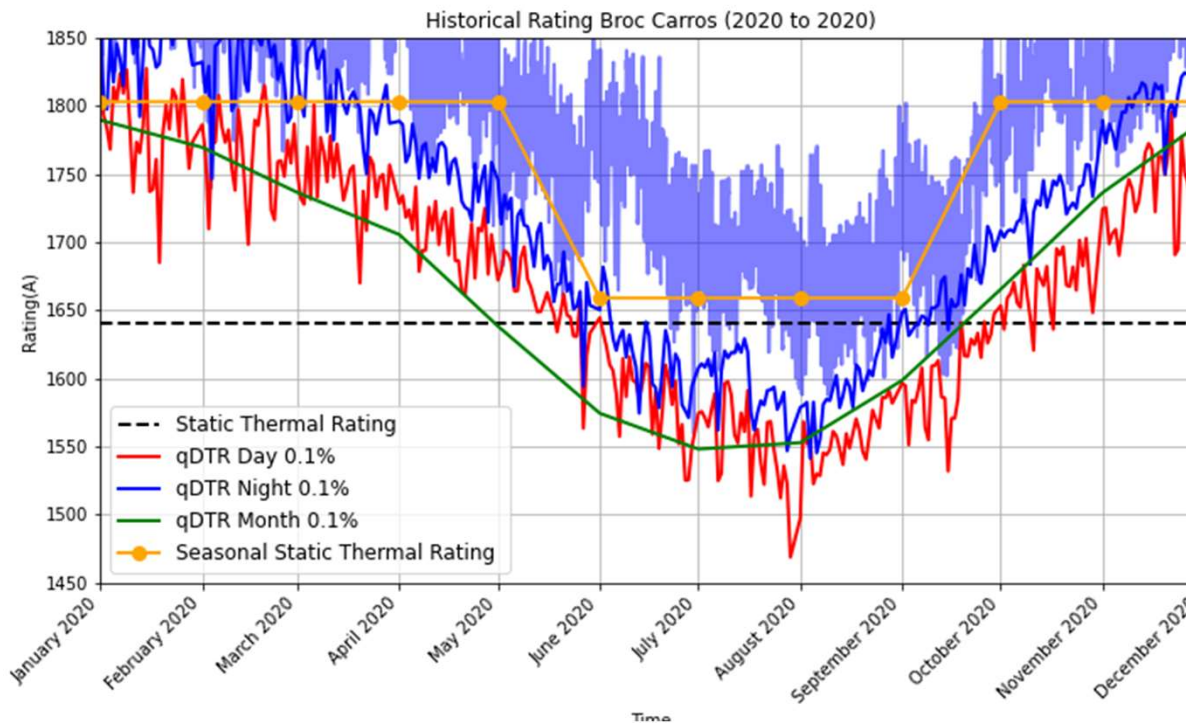

qDTR Day/Night [0.1%] Per Power System Component

qDTR Monthly [0.1%] Per Power System Component

$$I_{qDTR}(V_w, \phi_w, \theta_a, H) \forall t \in [1, 2 \dots 24]$$

$$\forall \theta < \theta_{Thermal\ Limit}$$

METHODS Q1 : QUASI - DTR

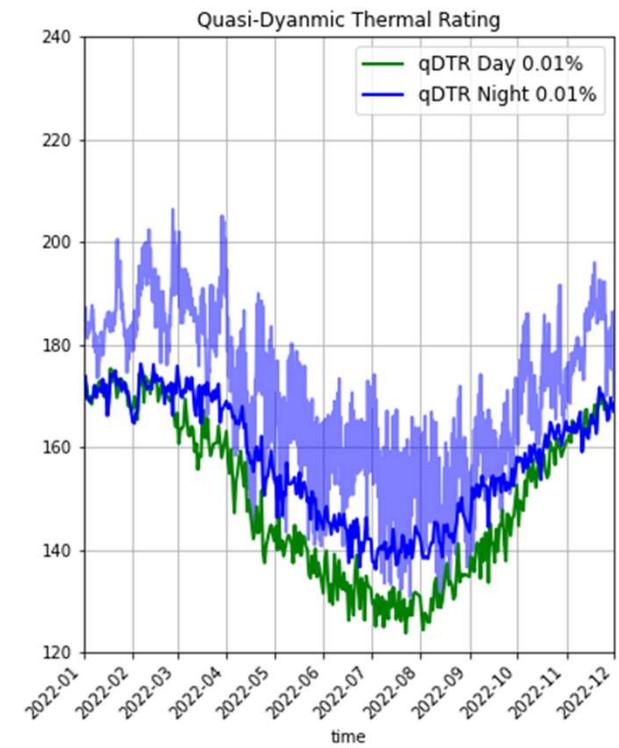
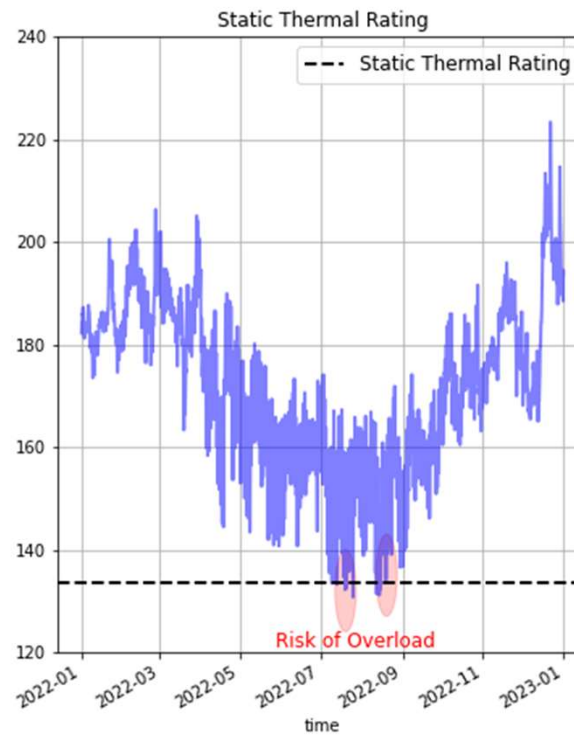
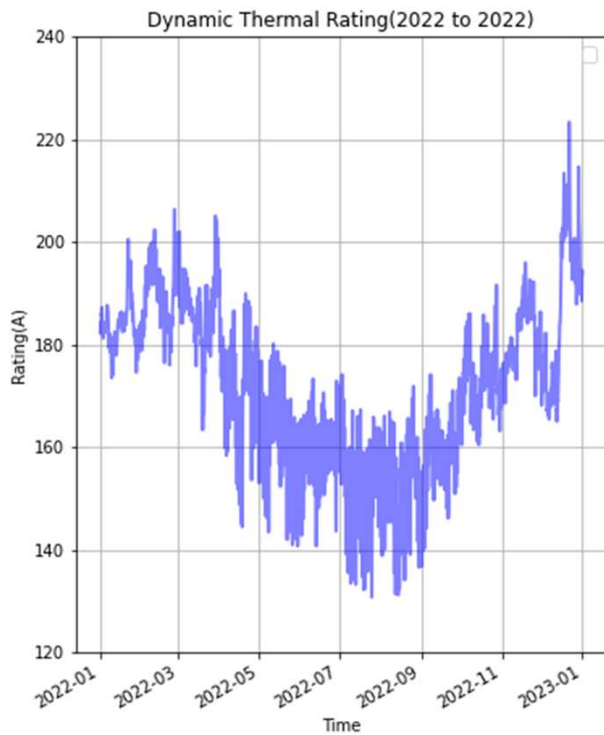
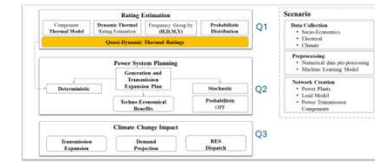

$$I_{qDTR}(V_w, \phi_w, \theta_a, H) \forall t \in [1, 2 \dots 24]$$

$$\forall \theta < \theta_{Thermal Limit}$$

METHODS Q2 : POWER SYSTEM PLANNING

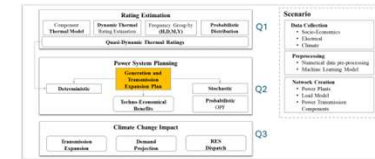

Generation Expansion Plan

$$\min \sum_t OPEX + \sum_{Gen} CAPEX$$

OPEX: - Operating cost of generation units

CAPEX: - Cost Building generation

subject to

- Market Clearance optimization
- Generation–demand balance
- Generator limits
- Ramping constraints

[1]

Network Expansion Plan

$$\min \sum_t OPEX + \sum_{lines+PT} CAPEX$$

- OPEX: - Load-shedding cost
 - Losses
 - Operating cost of generation units
- CAPEX: - Cost of Building new lines
 - Upgrading

subject to

- Power balance constraints
- Branch power flow limit
- Generator limits
- Network constraints

[1]

METHODS Q2 : POWER SYSTEM PLANNING

$$f(x) = \min \sum_t OPEX_{g+l} + \sum_{Gen,lines} CAPEX_{l+g}$$

$$\min_{P_g^G, \hat{P}_g^G, z_{i,j}^L} \sum_t w_t \left(\sum_{g \in G} (C_{g,t} P_{g,t}^G) \right) + \sum_{g \in G} (I_g \hat{P}_{g,t}^G) + \sum_{i,j \in L} (I_{(i,j)} z_{i,j}^L)$$

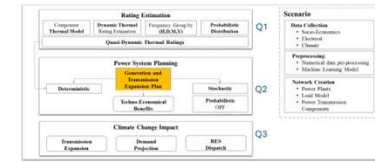

METHODS Q2 : POWER SYSTEM PLANNING

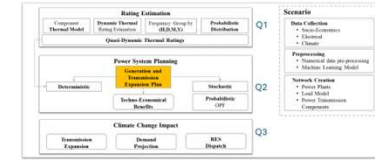

$$f(x) = \min \sum_t OPEX_{g+l} + \sum_{Gen,lines} CAPEX_{l+g}$$

$$\min_{P_g^G, \hat{P}_g^G, z_{i,j}^L} \sum_t w_t \left(\sum_{g \in G} (C_{g,t} P_{g,t}^G) \right) + \sum_{g \in G} (I_g \hat{P}_{g,t}^G) + \sum_{i,j \in L} (I_{(i,j)} z_{i,j}^L)$$

Subject to:

$$\sum_{g \in N_i^G} P_{g,t}^G - \sum_{(i,j) \in N_i^L} P_{(i,j),t}^L = \sum_{d \in N_i^D} P_{d,t}^D \quad \forall i \in N$$

$$\hat{P}_{g,t}^G g_{g,t}^{Prmin} \geq P_{g,t}^G \geq \hat{P}_{g,t}^G g_{g,t}^{Prmax} \quad \forall g \in G, t$$

$$g_g^{P_{Gmin}} \geq \hat{P}_g^G \geq g_g^{P_{Gmax}} \quad \forall g \in G$$

$$|P_{(i,j),t}^L| \leq P_{(i,j),t}^{L,max} (z_{ij}^L + z_0) \quad \forall (i,j) \in L$$

$$0 \leq z_{ij}^L \leq z_{ij}^{max} \quad \forall (i,j) \in L$$

$$P_{(i,j)}^L = \frac{(\theta_i^L - \theta_j^L)}{X_{ij}} \quad \forall (i,j) \in L$$

Nodal Balance

Generator Constrains

Lines Constrains OPFDC

Limit Capacity (Thermal Limit)

METHODS Q2 : OPF

$$\min_{P_g^G} \sum_{g \in G} (C_g P_g^G)$$

$$\sum_{g \in N_i^G} P_g^G - \sum_{(i,j) \in N_i^L} P_{(i,j)}^L = \sum_{d \in N_i^D} P_d^D \quad \forall i \in N$$

$$g_g^{PGmin} \geq P_{g,t}^G \geq g_g^{PGmax} \quad \forall g \in G$$

$$|P_{(i,j)}^L| \leq P_{(i,j)}^{L,max} \quad \forall (i,j) \in L$$

$$P_{(i,j)}^L = \frac{(\theta_i^L - \theta_j^L)}{X_{ij}} \quad \forall (i,j) \in L$$

$$\theta_{ref} = 0$$

$$-\pi \leq \theta_i - \theta_j \leq \pi \quad \forall (i,j) \in N$$

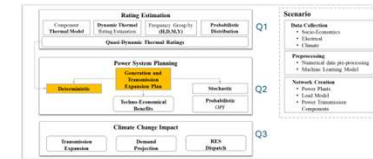

METHODS Q2 : OPF

$$\min_{P_g^G} \sum_{g \in G} (C_g P_g^G)$$

$$\sum_{g \in N_i^G} P_g^G - \sum_{(i,j) \in N_i^L} P_{(i,j)}^L = \sum_{d \in N_i^D} P_d^D \quad \forall i \in N$$

$$g_g^{PGmin} \geq P_{g,t}^G \geq g_g^{PGmax} \quad \forall g \in G$$

$$|P_{(i,j)}^L| \leq P_{(i,j)}^{L,max} \quad \forall (i,j) \in L \longrightarrow$$

$$P_{(i,j)}^L = \frac{(\theta_i^L - \theta_j^L)}{X_{ij}} \quad \forall (i,j) \in L$$

$$\theta_{ref} = 0$$

$$-\pi \leq \theta_i - \theta_j \leq \pi \quad \forall (i,j) \in N$$

$$I_{\{OHL\}} = \sqrt{\frac{Q_r(\theta_a) + Q_c(\theta_a, W_s) - Q_s(S_r)}{R(\theta_a)}}$$

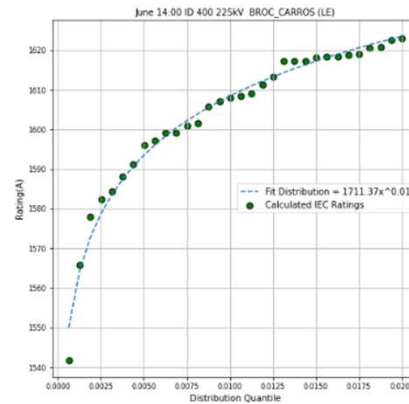

$$CDF_w = f(I_{max} \leq x) \cdot V$$

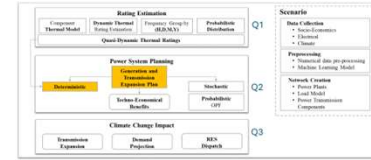

METHODS Q2 : OPF

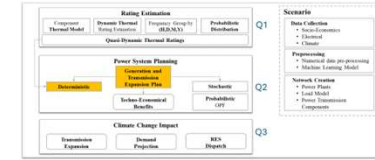

$$\min_{P_g^G} \sum_{g \in G} (C_g P_g^G)$$

$$\sum_{g \in N_i^G} P_g^G - \sum_{(i,j) \in N_i^L} P_{(i,j)}^L = \sum_{d \in N_i^D} P_d^D \quad \forall i \in N$$

$$g_g^{PGmin} \geq P_{g,t}^G \geq g_g^{PGmax} \quad \forall g \in G$$

$$|P_{(i,j)}^L| \leq P_{(i,j)}^{L,max} \quad \forall (i,j) \in L \longrightarrow$$

$$P_{(i,j)}^L = \frac{(\theta_i^L - \theta_j^L)}{X_{ij}} \quad \forall (i,j) \in L$$

$$\theta_{ref} = 0$$

$$-\pi \leq \theta_i - \theta_j \leq \pi \quad \forall (i,j) \in N$$

$$I_{\{OHL\}} = \sqrt{\frac{Q_r(\theta_a) + Q_c(\theta_a, W_s) - Q_s(S_r)}{R(\theta_a)}}$$

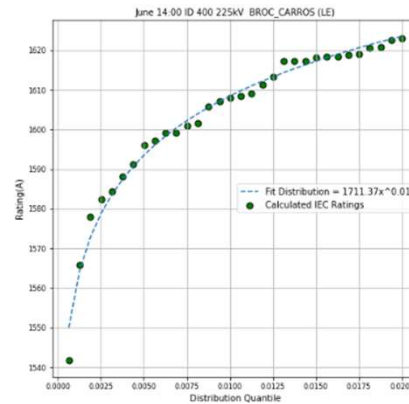

$$\sum_{g \in N_i^G} P_g^G - \sum_{(i,j) \in N_i^L} P_{(i,j)}^L = \sum_{d \in N_i^D} P_d^D \quad \forall i \in N$$

$$g_g^{PGmin} \geq P_{g,t}^G \geq g_g^{PGmax} \quad \forall g \in G$$

$$|P_{(i,j)}^L| \leq CDF_{w(i,j)} \quad \forall (i,j) \in L$$

$$P_{(i,j)}^L = \frac{(\theta_i^L - \theta_j^L)}{X_{ij}} \quad \forall (i,j) \in L$$

$$\theta_{ref} = 0$$

METHODS – DATA AND SCENARIOS

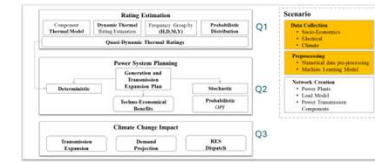

- **Socio-Economics**
 - Regional Geometry (NUTS)
 - Historical and Projected: GDP and Population
- **Electrical**
 - Historical and Electrical Demand (Country)
 - Generation Capacity
 - Cable Parameters
 - Lines Location
 - Soil Taxonomy
 - Generator techno-economic



European Network of Transmission System Operators for Electricity



ERA5 Hourly Data On Single Levels From 1940 To The Present

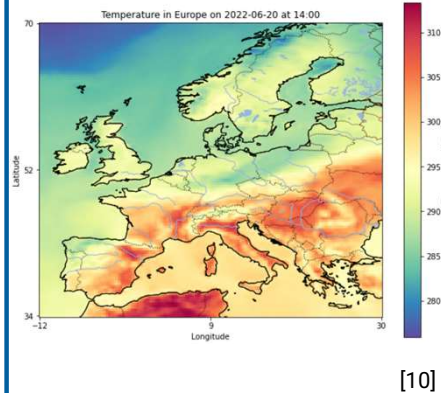

Climate And Energy Indicators For Europe From 2005 To 2100 Derived From Climate Projections

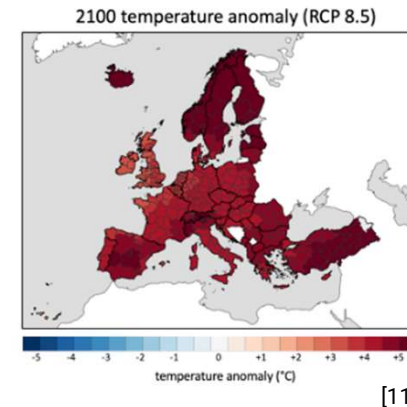

[10]Hersbach, et al : ERA5 hourly data on single levels from 1940 to present. Copernicus Climate Change Service (C3S)
 [11] Copernicus Climate Change Service (2021): Climate and energy indicators for Europe from 2005 to 2100 derived from climate projections. Copernicus Climate Change Service (C3S) Climate

5. Results



Weather-Based Quasi Dynamic Thermal Ratings for Power Transformers

Sergio Daniel Montaña Salas
Centre PERSEE,
Mines Paris - PSL,
Sophia Antipolis, France
sergio-daniel.montana-salas@minesparis.psl.eu

Andrea Michiorri
Centre PERSEE,
Mines Paris - PSL,
Sophia Antipolis, France
andrea.michiorri@minesparis.psl.eu

IEEE TRANSACTIONS ON DIELECTRICS AND ELECTRICAL INSULATION, VOL. 30, NO. 3, JUNE 2023

Long-term Dynamic Thermal Ratings of Underground Cables Integrating Soil Dynamics and Climate Projections

Montaña Salas Sergio, Michiorri Andrea

Abstract—The capacity of underground cables is influenced by thermal properties, particularly the interplay between the dynamics of their physical properties and the surrounding soil's heat dissipation capabilities. This paper introduces a new approach to quantify the long-term effect of climate conditions on the dynamic thermal rating of cables, taking into account the variability of soil temperature and moisture in the depth range of 0.8 to 1.2 meters. The research extends its focus to assess the impact of climate change using various representative concentration pathways across 12 temperature stations. The main strength of this model lies in its ability to offer detailed estimations by capturing the relationships among different types of soil. The results show that the quasi-Dynamic Thermal Rating methodology produces an average increase in ratings of 24.5%. In addition, it has the potential to further reduce the disparity between winter and summer seasons, with an increase of up to 8.1%. Regarding climate impact, there are moderate reductions over the simulation term extension horizon, with an average reduction of 8.27% to 6.84%.

Index Terms—Underground Power Transmission Lines, Climate Change, Dynamic Thermal Rating, Soil, Power transmission meteorological factors, Thermal Factors.

I. INTRODUCTION

THE rising adoption of underground cables (UGC), driven by expanding renewable generation plants [1]–[3], poses a challenge for a warmer, energy-demanding future [4]. Meteorological factors and climate change significantly affect UGC capacity, which is mainly related to the surrounding soil's effectiveness in dissipating peak losses. This heat transfer mechanism, impacted by moisture and soil thermal resistivity, has the potential for up to 30% capacity reduction [5]. However, this reduction cannot be captured by the traditional approach taken by energy utilities. In this context, large-scale soil factor measurements play a crucial role. However, only historical high-resolution models combining data with observations have emerged in the last decade [6]–[7], with a gap in long-term projections for burial depths between 1 and 5 meters. This underscores the significance of our research in understanding the complexity of climate-induced changes and their implications for the transmission sector over the long term.

To cope with the effects of rising temperatures and optimize the energy-carrying capacity of cables, Dynamic Thermal Rating (DTR) [8]–[14] is actively proposed as a solution. This technology aims to identify the real-time current-carrying capacity in order to optimize asset utilization, reduce congestion and improve efficiency as a function of environmental

conditions, such as ambient and soil temperature. It is crucial to emphasize that the primary objective, as presented in [15], positions DTR as a strategic tool for system operators. DTR helps to accurately and reliably determine current rating limits, thereby alleviating constraints based on thermal considerations.

As temperature is the primary variable in DTR, weather and mechanical characteristics can be determined using two methods: 1) Real-time measurement approaches, known as direct measurement. Nowadays, this is usually performed for brand new circuits with an embedded optical fiber as described in [16], offering excellent accuracy and precision, but with issues such as capital costs and non-applicability to already installed networks. 2) A thermal mathematical model based on information on meteorological conditions, combined with a non-steady-state thermal model using historical data or meteorological predictions [17]. This method increases capacity compared to static thermal power but reduces the risk of overloading.

When this model is applied, meteorological factors and climate change have a discernible impact on the DTR rating [9], as established by well-known international standards such as IEEE Std 1863 [18] and IEC 60287 [19]. This impact is vital in defining the parameters used for rating estimations, described by energy conservation and the heat transfer mechanisms [20] of the cable's physical properties and the heat dissipation capabilities of the surrounding soil. Notably, the heat balance highlights the challenge of heat loss dissipation in UGC, exposed directly to the environment (directly buried in the soil). Understanding and quantifying these factors is critical to increasing UGC systems' thermal performance and overall efficiency.

A crucial parameter influencing the rating within the soil's thermal properties is the soil thermal resistivity (ρ_{soil}), which is highly correlated with the moisture content [18], [19], [21]. This effect becomes particularly significant when its impact is translated into temperature. In [21], a 50% reduction in the rating is observed when the soil thermal resistivity is three times greater and the ambient temperature increases by 5°C. This reinforces its high dependence and the correlation between the temperature and moisture of the surrounding soil, among other factors, such as loading depth and physical properties [22].

The utilization of in-situ sensors for measuring soil moisture and temperature at various spatial locations, as discussed in [23], presents an opportunity to comprehend the interrelationship



The Climate Change Impact on Power Grid Transmission Capacity

MONTAÑA Sergio¹ and MICHIORRI Andrea¹

¹PERSEE, Mines Paris - PSL, Centre for processes, Sophia Antipolis, 06600, Alpes-Maritimes, France.

*Corresponding author(s). E-mail(s): sergio-daniel.montana-salas@minesparis.psl.eu; Contributing authors: andrea.michiorri@minesparis.psl.eu;

Abstract

Proposing practical solutions to mitigate climate change effects on the electrical power system requires a comprehensive understanding and quantification. By conducting an assessment at high grid resolution, this article explores the impact of climate on transmission network capacity, employing established thermal models and a regional expansion plan. The results indicate average reductions of 1.55%, 2.35%, and 0.2% for overhead lines, power transformers, and underground cables, respectively. We propose a quasi-Dynamic Thermal Rating method to counter these effects, estimating maximum capacity. This approach enhances component capacity by an average of up to 35% during winter at the power transformers and up to 14% during nighttime hours for overhead lines. This solution constitutes a viable alternative for electricity operators, to address the dilemma between the necessity of reducing the failure rate/decrease in capacity, and the imperative need for new investments in transmission assets.

Keywords Climate Change, Dynamic Thermal Rating, Power Systems

1 Introduction

Climate change projections estimate an average atmospheric temperature increase of 2–4°C until the end of the century [1, 2]. This will directly and negatively impact the electric power system, affecting transmission capacity, generation, demand, and congestion.



Assessing Regional Capacity Expansion: The Role of Quasi-Dynamic Thermal Ratings in a Changing Climate

Sergio-Daniel Montaña-Salás
Centre PERSEE,
Mines Paris - PSL,
Sophia Antipolis, France
sergio-daniel.montana-salas@minesparis.psl.eu

Andrea Michiorri
Centre PERSEE,
Mines Paris - PSL,
Sophia Antipolis, France
andrea.michiorri@minesparis.psl.eu

Abstract—Proposing practical solutions to mitigate the effects of climate change on the electricity system requires thorough understanding and quantification. This paper introduces a new method of quantifying dynamic network capacity at the transmission level, using established thermal models and a set of regional expansion plans. The results suggest this approach can increase component capacity by up to 21% during winter and up to 14% during nighttime hours for overhead lines. This approach offers a viable option for electricity operators to address the challenge of balancing the need to reduce failure rates and capacity loss with the critical demand for new investment in transmission assets, reducing more than 1% of system cost expansion by 2065.

Index Terms—Climate Change, Dynamic Thermal Rating, Power transmission meteorological factors, Thermal Factors.

I. INTRODUCTION

This paper presents the findings of research on regional network expansion planning, taking into account the impact of climate change on transmission network equipment. As emphasized by [1], a transmission network expansion up to 80 million kilometers in Europe is possible, while transmission capacity reduction from 1.5% to 5.5% is expected in the United States [2]. These challenges underscore the importance of analyzing future investments and developing new flexibility strategies using established methods.

Regarding the transmission network, various solutions have been proposed to alleviate network congestion problems. One of them is the implementation of Dynamic Thermal Rating (DTR) on critical transmission lines. This technology aims to identify network components' real-time current-carrying capacity, typically higher than their static nominal value. By doing so, DTR enables the reduction of network congestion, associated curtailments, and delays or the avoidance of network reinforcements while simultaneously enhancing reliability. It can be integrated into power system expansion plans [3]–[4], but its dependency on meteorological factors, such as ambient temperature, makes it particularly sensitive to climate change.

Climate scenario models and trajectories have been published for specific road maps. Among these, quantitative projections, such as Representative Concentration Pathways (RCPs) and Shared Socio-Economic Pathways (SSPs), provide valuable tools for assessing regional climate changes and their specific impacts on the energy sector. Indeed, electricity demand is expected to increase up to 21% [5], a key factor in determining capacity expansion planning.

In academic literature, the Long-Term Demand Forecasting Methods (LDFM) are often described as incorporating trend analysis, econometric modeling, or combined analysis, as discussed in [6], [7]. These methods explore linear and non-linear relationships among economic indicators, demographic factors, and weather variables such as Gross Domestic Product (GDP), ambient temperature, and population. Furthermore, statistical and machine-learning algorithms have been explored for this task.

As a main contribution, this research aims to quantify the impact of climate change on power system transmission capacity as a part of strategic planning methodology for a regional utility with the following approach:

- Deriving a quasi-Dynamic Thermal Rating (qDTR) algorithm as the first solution to recover the lost transmission capacity.
- Quantify the impact of climate change on power system transmission capacity considering future climate projections datasets.

The paper is organized as follows: Section II illustrates the load demand forecast, thermal model, and methodology. The results are described in Section III, and conclusions are drawn in Section IV.

II. METHODOLOGY

A. Overview
We introduce a model to assess the long-term effects of climate conditions on regional capacity, employing qDTR as a critical metric in II-B. This model is delineated in Fig. 1. Initially, a regression machine learning model is trained using

978-1-963-9678-2/23/00 02023 IEEE



ISGT-2023
Paper 1

Submitted / R0
Paper 2

In preparation
Paper 3

Submitted / R0
Paper 4



Weather-Based Quasi Dynamic Thermal Ratings for Power Transformers

Sergio Daniel Montaña-Salas
Centre PERSEE,
Mines Paris - PSL,
Sophia Antipolis, France
sergio-daniel.montana-salas@minesparis.psl.eu

Andrea Michiorri
Centre PERSEE,
Mines Paris - PSL,
Sophia Antipolis, France
andrea.michiorri@minesparis.psl.eu

Abstract—This paper presents a preliminary study on climate change's impact on power transformers' ratings. This study focuses on the difference between air temperature and the maximum continuous allowable hot spot oil temperature. On the other hand, atmospheric temperature is expected to rise in the following years in Europe in a range between 0.52 °C and 3.05 °C, depending on the scenario. This will result in a rating reduction for existing and newly installed transformers. This study proposes a methodology to quantify this phenomenon and estimate its effect on several use cases. This is achieved by combining the transformer thermal model described in the IEEE C57.101, loading guide, historical meteorological data for 1976-2021, and climate projections for 2022-2052 based on different greenhouse gas emission hypotheses. Simulations are carried out using a quasi-Dynamic Thermal Rating approach for HV transformers in the southwestern region of France.

Results show how the methodology proposed allows for a 4% rating increase in the cooler hours of the day and that projected future ratings are expected to be 1.61% - 4.16% lower than the historical ones.

Index Terms—Power Transformers - Dynamic Thermal Rating - Probabilistic forecasting

I. INTRODUCTION

The climate change repercussions on the electric network have been analysed in [1], [2], showing transmission rating reductions from 5% to 15% over the long term and mainly influenced by ambient temperature. The effects of this rating reduction and new energy demand projections in [3], involve significant and costly network reinforcement or expansion to maintain the system's reliability.

In the transmission and distribution network, power transformers (PT) are critical assets connecting power plants and customers. Their failure could lead to outages, environmental risks, up to loss of life.

Therefore, with projections that anticipated a rise in the peak temperature range between 0.52% and 3.18% for the coming five decades in Europe [4] (as observed in Fig. 1), the thermal stress increases the risk of premature failure and reduces the PT's rating.

According to the International Electrotechnical Commission (IEC) and the Institute of Electrical Electronics Engineers (IEEE) loading guides [5], the rating of a PT is usually

governed by the thermal limit or hot spot temperature (HST). Its accurate identification will provide essential information for life estimation, asset management strategies, and flexible scheduling. It can also be used to mitigate the risk of failure and to develop monitoring strategies. For this reason, transformers operating temperature has been investigated in the last few years under the following strategies: The conventional Static Thermal Rating (STR), which international standards have extensively analysed [6] [7] using the thermal models investigated in [8] [9], and that is based on estimation of typical and conservative assumptions, together with safety and ageing criteria. However, despite its prolonged use, it only approximates the actual thermal values because it does not consider the instantaneous atmospheric conditions and the load profile [2]. The second is the Dynamic Thermal Rating (DTR) strategy, which determines the rating limits based on time-variable environmental conditions, such as air temperature.

The third option, always within the concept of DTR, relies on direct temperature measurement, usually with a fibre optic sensor, [6], but this is often possible only for new transformers [10].

In this field, the application of the DTR approach is a proven concept and is presented as an alternative to improve the flexibility of the network in many scenarios. The main objectives are 1) increased transmission system efficiency and improvement reliability [2], and 2) Decreased or deferred investments to reinforce or expand the existing network, where PT is often among the most expensive assets [10]. As this paper focuses on combining probabilistic thermal modelling and big data to determine the DTR of oil-immersed transformers, this section only reviews relevant works from the last decade.

Relevant literature addresses the evaluation of HST effect as the main parameter for determining the insulation ageing and its rating. In [11], the authors proposed a risk-based approach using a quantile Regression (QR) model to forecast the HST from the dynamic thermal model of the transformer. The results were developed in seasonal and hourly yield, and a field acceptable risk level validated the proposal from an energy and economic point of view. Another approach was developed in [12], [13] that employs thermal models from the IEC and IEEE guidelines to investigate the effect

2024 TRANSACTIONS, VOL. X, NO. X, AUGUST 2024

Long-term Dynamic Thermal Ratings of Underground Cables Integrating Soil Dynamics and Climate Projections

Montaña-Salas Sergio, Michiorri Andrea

Abstract—The capacity of underground cables is influenced by thermal properties, particularly the interplay between the dynamics of their physical properties and the surrounding soil's heat dissipation capabilities. This paper introduces a new approach to quantify the long-term effect of climate change on the capacity of underground cable capacity. To do so, it leverages machine learning techniques to estimate soil temperature and moisture in the depth range of 0.8 to 1.2 meters. The research results in the form of a novel type of climate change using various representative concentration pathways serve to determine the main effects of the model lies in its ability to offer detailed estimations by capturing the relationships among different types of soil. The results show that the quasi-Dynamic Thermal Rating methodology produces an average increase in ratings of 2.1%. In addition, it has the potential to further reduce the disparity between winter and summer seasons, with an increase of up to 0.15 °C. Regarding climate impact, there are moderate reductions over the medium-term extension horizon, with an average reduction of 0.27% to 0.67%.

Index Terms—Underground Power Transmission Lines, Climate Change, Dynamic Thermal Rating, Soil, Power transmission meteorological factors, Thermal Factors.

I. INTRODUCTION

The rising adoption of underground cables (UGC), driven by expanding renewable generation plants [1]-[4], poses a challenge for a warmer, energy-demanding future [4]. Meteorological factors and climate change significantly affect UGC capacity, which is mainly related to the surrounding soil's effectiveness in dissipating peak losses. This heat transfer mechanism, impacted by moisture and soil thermal resistivity, has the potential for up to 30% capacity reduction [5]. However, this reduction cannot be captured by the traditional approach taken by energy utilities. In this context, large-scale soil factor measurements play a crucial role. However, only historical high-resolution models combining data with observations have emerged in the last decade [6], [7], with a gap in long-term projections for burial depths between 1 and 5 meters. This underscores the significance of our research in understanding the complexities of climate-induced changes and their implications for the transmission sector over the long term.

To cope with the effects of rising temperatures and optimize the energy-carrying capacity of cables - Dynamic Thermal Rating (DTR) [5], [9], [14] is actively proposed as a solution. This technology aims to identify the real-time current-carrying capacity in order to optimize asset utilization, reduce congestion and improve efficiency as a function of environmental

conditions, such as ambient and soil temperatures. It is crucial to emphasize that the primary objective, as presented in [5], positions DTR as a strategic tool for system operators. DTR helps to accurately and reliably determine current rating limits, thereby alleviating constraints based on thermal considerations.

As temperature is the primary variable in DTR, weather and mechanical characteristics can be determined using two methods: 1) Real-time measurement approaches, known as direct measurement. Nowadays, this is usually performed for brand new circuits with an embedded optical fiber as described in [16], offering excellent accuracy and precision, but with inherent such as capital costs and non-applicability to already installed networks. 2) A thermal mathematical model based on information on meteorological conditions, combined with a non-steady-state thermal model using historical data or meteorological predictions [17]. This method increases capacity compared to static thermal power but reduces the risk of overloading.

When this model is applied, meteorological factors and climate change have a discernible impact on the DTR rating [8], as established by well-known international standards such as IEEE Std 1863 [18] and IEC 60287 [19]. This impact is vital in defining the parameters used for rating estimations, described by energy conservation and the heat transfer mechanisms [20] of the cable's physical properties and the heat dissipation capabilities of the surrounding soil. Notably, the heat balance highlights the challenge of low heat dissipation in UGC, exposed directly to the environment (directly buried in the soil). Understanding and quantifying these factors is critical to increasing UGC systems' thermal performance and overall efficiency.

A crucial parameter influencing the rating within the soil's thermal properties is the soil thermal resistivity (C_{soil}), which is highly correlated with the moisture content [18], [19], [21]. This effect becomes particularly significant when its impact is translated into temperature. In [5], a 30% reduction in the rating is observed when the soil thermal resistivity is three times greater and the ambient temperature increases by 5 °C. This translates to high dependence and the correlation between the temperature and moisture of the surrounding soil, among other factors, such as loading depth and physical properties [22].

The utilization of in-situ sensors for measuring soil moisture and temperature at various spatial scales, as discussed in [23], presents an opportunity to comprehend the interrelationship



The Climate Change Impact on Power Grid Transmission Capacity

MONTAÑA Sergio¹ and MICHIORRI Andrea¹

¹PERSEE, Mines Paris - PSL, Centre for processes, Sophia Antipolis, 06600, Alpes-Maritimes, France.

*Corresponding author(s). E-mail(s): sergio-daniel.montana-salas@minesparis.psl.eu; Contributing authors: andrea.michiorri@minesparis.psl.eu;

Abstract

Proposing practical solutions to mitigate climate change effects on the electrical power system requires a comprehensive understanding and quantification. By conducting an assessment at high grid resolution, this article explores the impact of climate on transmission network capacity, employing established thermal models and a regional expansion plan. The results indicate average reductions of 1.55%, 2.35%, and 0.25% for overhead lines, power transformers, and underground cables, respectively. We propose a quasi-Dynamic Thermal Rating method to counter these effects, estimating maximum capacity. This approach enhances component capacity by an average of up to 35% during winter at the power transformers and up to 14% during nighttime hours for overhead lines. This solution constitutes a viable alternative for electricity operators, to address the dilemma between the necessity of reducing the failure rate/decrease in capacity, and the imperative need for new investments in transmission assets.

Keywords Climate Change, Dynamic Thermal Rating, Power Systems

1 Introduction

Climate change projections estimate an average atmospheric temperature increase of 2.4°C until the end of the century [1], [2]. This will directly and negatively impact the electric power system, affecting transmission capacity, generation, demand, and congestion.

Assessing Regional Capacity Expansion: The Role of Quasi-Dynamic Thermal Ratings in a Changing Climate

Sergio-Daniel Montaña-Salas
Centre PERSEE,
Mines Paris - PSL,
Sophia Antipolis, France
sergio-daniel.montana-salas@minesparis.psl.eu

Andrea Michiorri
Centre PERSEE,
Mines Paris - PSL,
Sophia Antipolis, France
andrea.michiorri@minesparis.psl.eu

Abstract—Proposing practical solutions to mitigate the effects of climate change on the electricity system requires thorough understanding and quantification. This paper introduces a new method of quantifying dynamic network capacity at the transmission level, using established thermal models and a set of regional expansion plans. The results suggest this approach can increase component capacity by up to 21% during winter and up to 14% during nighttime hours for overhead lines. This approach offers a viable option for electricity operators to address the challenge of balancing the need to reduce failure rates and capacity loss with the critical demand for new investment in transmission assets, reducing more than 1% of system cost expansion by 2068.

Index Terms—Climate Change, Dynamic Thermal Rating, Power transmission meteorological factors, Thermal Factors.

I. INTRODUCTION

This paper presents the findings of research on regional network expansion planning, taking into account the impact of climate change on transmission network equipment. As emphasized by [1], a transmission network expansion up to 80 million kilometers in Europe is possible, while transmission capacity reduction from 1.5% to 5.8% is expected in the United States [2]. These challenges underscore the importance of analyzing future investments and developing new flexibility strategies using established methods.

Regarding the transmission network, various solutions have been proposed to alleviate network congestion problems. One of them is the implementation of Dynamic Thermal Rating (DTR) on critical transmission lines. This technology aims to identify network components' real-time current-carrying capacity, typically higher than their static nominal value. By doing so, DTR enables the reduction of network congestion, associated curtailments, and delays or the avoidance of network reinforcements while simultaneously enhancing reliability. It can be integrated into power system expansion plans [3], [4], but its dependency on meteorological factors, such as ambient temperature, makes it particularly sensitive to climate change.

Climate scenario models and trajectories have been published for specific road maps. Among these, quantitative projections, such as Representative Concentration Pathways (RCPs) and Shared Socio-Economic Pathways (SSPs), provide valuable tools for assessing regional climate changes and their specific impacts on the energy sector. Indeed, electricity demand is expected to increase up to 21% [5], a key factor in determining capacity expansion planning.

In academic literature, the Long-Term Demand Forecasting Methods (LDFM) are often described as incorporating trend analysis, econometric modeling, or combined analysis, as discussed in [6], [7]. These methods explore linear and non-linear relationships among economic indicators, demographic factors, and weather variables such as Gross Domestic Product (GDP), ambient temperature, and population. Furthermore, statistical and machine-learning algorithms have been explored for this task.

As a main contribution, this research aims to quantify the impact of climate change on power system transmission capacity as a part of strategic planning methodology for a regional utility with the following approach:

- Deriving a quasi-Dynamic Thermal Rating (qDTR) algorithm as the first solution to recover the lost transmission capacity.
- Quantify the impact of climate change on power system transmission capacity considering future climate projections datasets.

The paper is organized as follows: Section II illustrates the load demand forecast, thermal model, and methodology. The results are described in Section III, and conclusions are drawn in Section IV.

II. METHODOLOGY

A. Overview
We introduce a model to assess the long-term effects of climate conditions on regional capacity, employing qDTR as a critical metric in H-B. This model is delineated in Fig. 1. Initially, a regression machine learning model is trained using

978-1-9031-9678-2/23/00 02023 IEEE



ISGT-2023
Paper 1

Submitted / R0
Paper 2

Submitted / R0
Paper 3

Submitted / R0
Paper 4

Q1: How estimate the DTR resource?

Q2: How can the DTR be included in PSP?

5.1 How to estimate the DTR resource?

RESULTS : UNDERGROUND CABLES INTEGRATING SOIL DYNAMICS

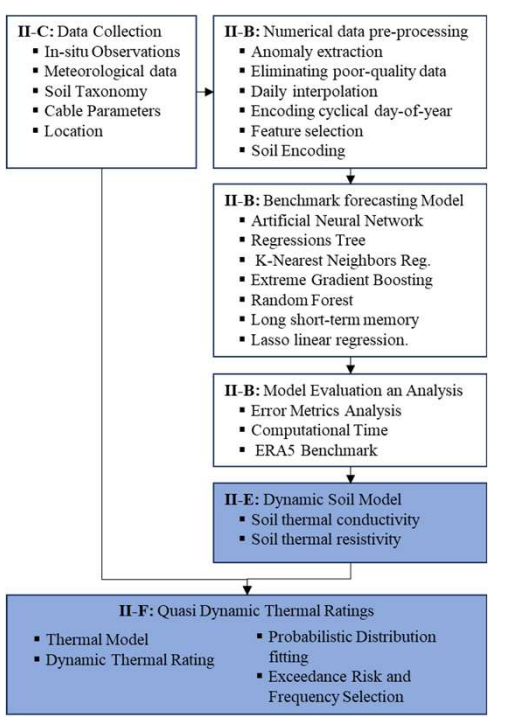

$$\lambda_{s_i} = (\lambda_{sat_i} - \lambda_{dr_i})K_{e_i} + \lambda_{dr_i} \text{ at } 2 \text{ mts}$$

$$K_{e_i} = \exp(\alpha - \psi_i^{-\beta}) \text{ at } 2 \text{ mts}$$

THEORETICAL MODELS
(Empirical model)

Develop thermal ratings for PSC based on climatic factors.

RESULTS : UNDERGROUND CABLES INTEGRATING SOIL DYNAMICS

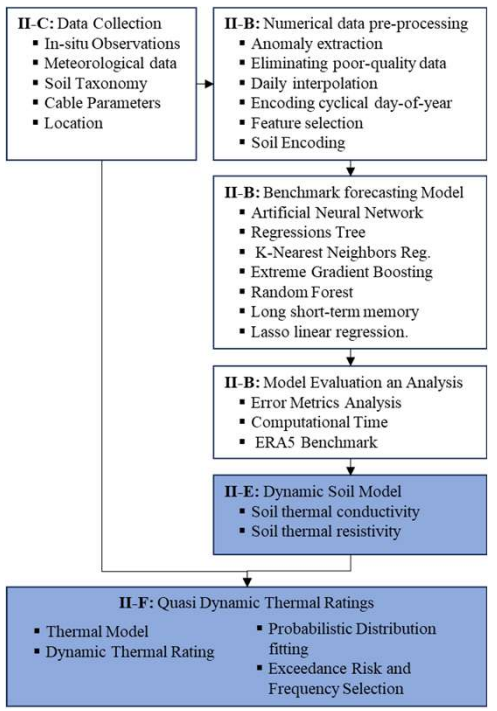

		Model						
		CV	0	1	2	3	4	ERA5
RMSE_80	0	2.23	2.03	2.29	2.15	2.39	2.72	
	1	2.69	2.43	2.73	2.63	2.83	3.64	
	2	2.92	4.81	3.19	3.16	3.37	2.76	
	3	2.02	1.85	2.25	1.90	2.14	2.90	
	4	2.89	3.48	2.60	3.11	2.70	3.56	
	Avg.	2.71	3.16	2.83	2.74	2.95	3.1	
MAE_80	0	2.23	2.03	2.29	2.15	2.39	2.72	
	1	2.56	4.61	2.85	2.84	3.06	2.18	
	2	1.71	1.55	1.95	1.61	1.87	2.32	
	3	2.55	3.14	2.26	2.77	2.38	2.58	
	4	2.64	2.96	3.03	2.56	3.41	2.21	
	Avg.	2.34	2.86	2.48	2.39	2.62	2.4	

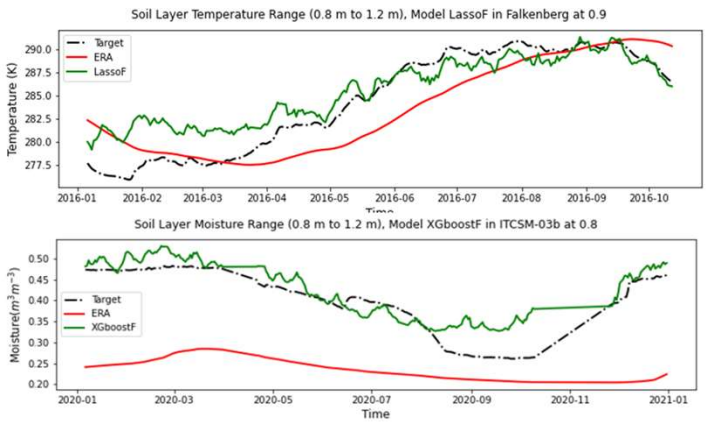

$$\lambda_{s_i} = (\lambda_{sat_i} - \lambda_{dry_i})K_{e_i} + \lambda_{dry_i} \text{ at } 2 \text{ mts}$$

$$K_{e_i} = \exp(\alpha - \psi_i^{-\beta}) \text{ at } 2 \text{ mts}$$

THEORETICAL MODELS
(Empirical model)

Develop thermal ratings for PSC based on climatic factors.

RESULTS : UNDERGROUND CABLES INTEGRATING SOIL DYNAMICS

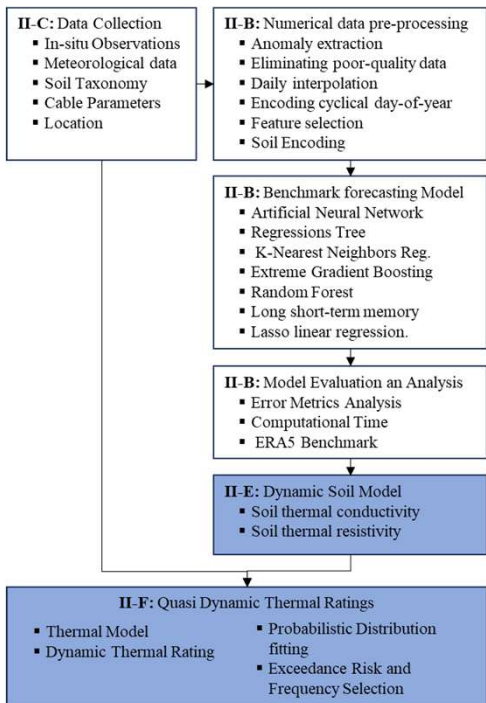

		Model						
		CV	0	1	2	3	4	ERA5
RMSE_80	0	2.23	2.03	2.29	2.15	2.39	2.72	
	1	2.69	2.43	2.73	2.63	2.83	3.64	
	2	2.92	4.81	3.19	3.16	3.37	2.76	
	3	2.02	1.85	2.25	1.90	2.14	2.90	
	4	2.89	3.48	2.60	3.11	2.70	3.56	
	Avg.	2.71	3.16	2.83	2.74	2.95	3.1	
MAE_80	0	2.23	2.03	2.29	2.15	2.39	2.72	
	1	2.56	4.61	2.85	2.84	3.06	2.18	
	2	1.71	1.55	1.95	1.61	1.87	2.32	
	3	2.55	3.14	2.26	2.77	2.38	2.58	
	4	2.64	2.96	3.03	2.56	3.41	2.21	
	Avg.	2.34	2.86	2.48	2.39	2.62	2.4	

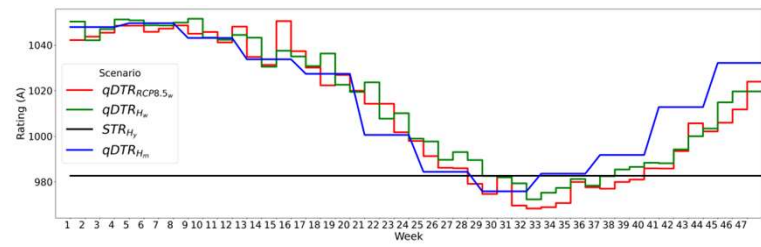
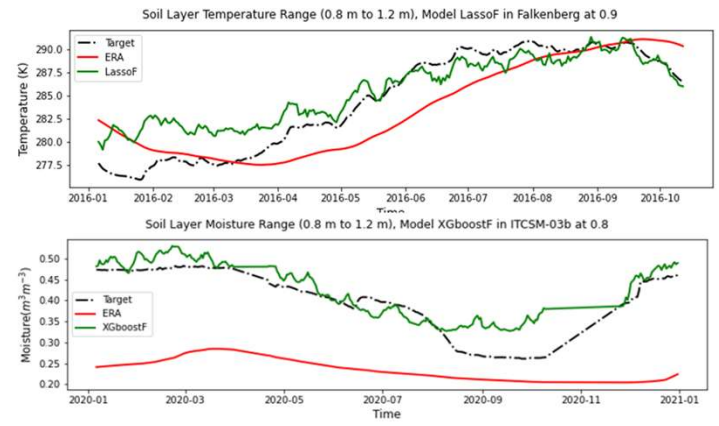
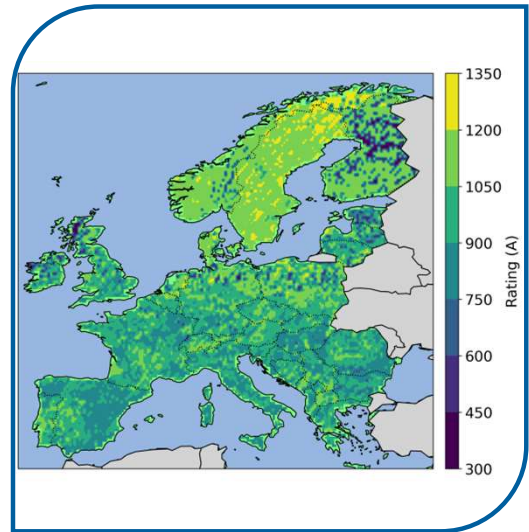

$$\lambda_{S_i} = (\lambda_{sat_i} - \lambda_{dry_i})K_{e_i} + \lambda_{dry_i} \text{ at } 2 \text{ mts}$$

$$K_{e_i} = \exp(\alpha - \psi_i^{-\beta}) \text{ at } 2 \text{ mts}$$

Develop thermal ratings for PSC based on climatic factors.

RESULTS : QUASI-DYNAMIC THERMAL RATINGS FOR POWER TRANSFORMERS

TABLE III: Average, minimum and maximum qDTR values compared to historical values

Description	Realtor ★	Biaçon ⬢	Broc-Carros ⬢	Tamareu ■	Tavel ▲
Hist Avg (A)	1716	1652	1711	1575	1636
Hist Max (A)	1851	1787	1862	1706	1805
Hist Min (A)	1543	1455	1519	1363	1340
2.6 RCP Avg	-0.3%	-0.2%	-0.2%	-0.3%	-0.4%
2.6 RCP Max	0.18%	0.45%	0.013%	0.6%	0.31%
2.6 RCP Min	0.06%	-0.8%	-1.0%	-2.1%	-0.8%
4.5 RCP Avg	-0.9%	-0.73%	-0.74%	-0.5%	-0.8%
4.5 RCP Max	-0.5%	0.647%	-0.8%	0.28%	-0.08%
4.5 RCP Min	-0.7%	-1.379%	-0.5%	-1.69%	-0.68%
8.5 RCP Avg	-1.67%	-1.69%	-1.62%	-1.01%	-2.07%
8.5 RCP Max	-1.03%	0.16%	-1.41%	-0.23%	-0.84%
8.5 RCP Min	-3.72%	-3.44%	-3.86%	-2.21%	-1.87%

Answer # 1 – Climate change could reduce average rating up to 2%

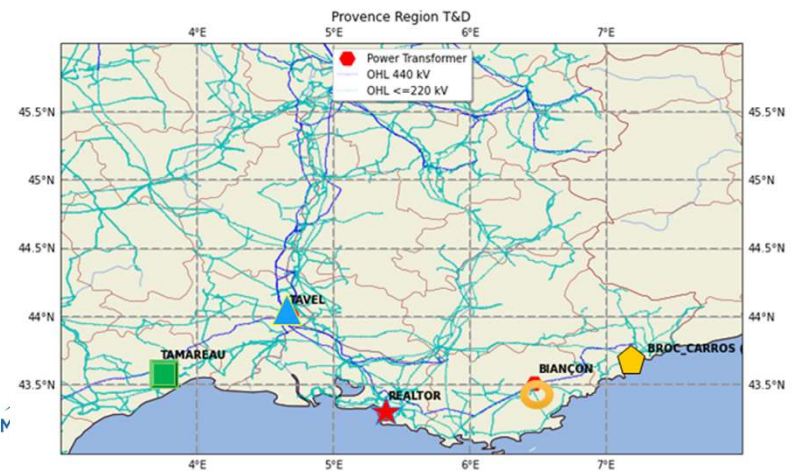

Develop thermal ratings for PSC based on climatic factors.

RESULTS : QUASI-DYNAMIC THERMAL RATINGS FOR POWER TRANSFORMERS

TABLE III: Average, minimum and maximum qDTR values compared to historical values

Description	Realtor ★	Biaçon ⬢	Broc-Carros	Tamareu ■	Tavel ▲
Hist Avg (A)	1716	1652	1711	1575	1636
Hist Max (A)	1851	1787	1862	1706	1805
Hist Min (A)	1543	1455	1519	1363	1340
2.6 RCP Avg	-0.3%	-0.2%	-0.2%	-0.3%	-0.4%
2.6 RCP Max	0.18%	0.45%	0.013%	0.6%	0.31%
2.6 RCP Min	0.06%	-0.8%	-1.0%	-2.1%	-0.8%
4.5 RCP Avg	-0.9%	-0.73%	-0.74%	-0.5%	-0.8%
4.5 RCP Max	-0.5%	0.647%	-0.8%	0.28%	-0.08%
4.5 RCP Min	-0.7%	-1.379%	-0.5%	-1.69%	-0.68%
8.5 RCP Avg	-1.67%	-1.69%	-1.62%	-1.01%	-2.07%
8.5 RCP Max	-1.03%	0.16%	-1.41%	-0.23%	-0.84%
8.5 RCP Min	-3.72%	-3.44%	-3.86%	-2.21%	-1.87%

Answer # 1 – Climate change could reduce average rating up to 2%

Map Of Provence Transmission Network With A Location Of PT

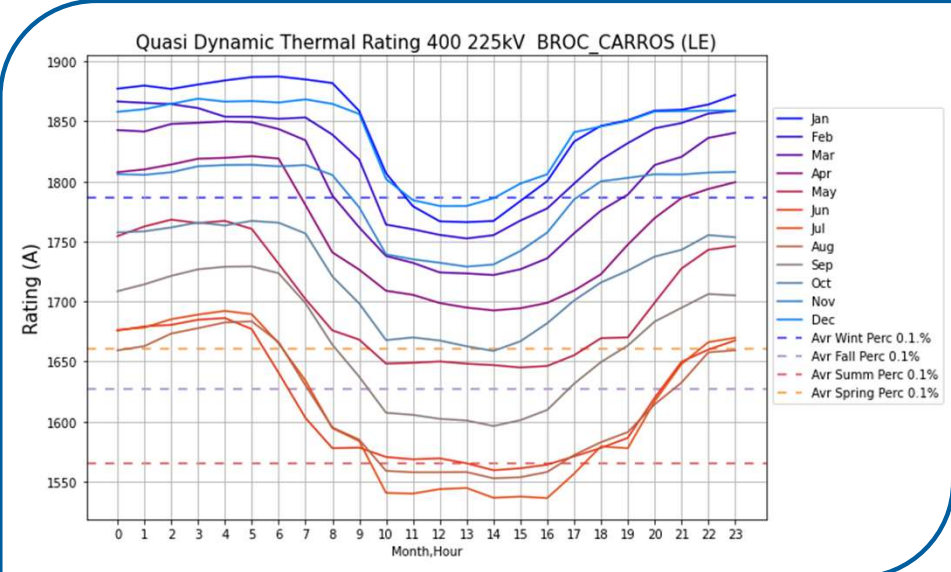

↑ Higher Ratings
↓ Reducing the risk of overloading

Answer # 2 – The qDTRs methodology introduced an average uplift in the region of 7.7%

Develop thermal ratings for PSC based on climatic factors.

Enhanced Transmission Capacity Probabilistic Dynamic Rating

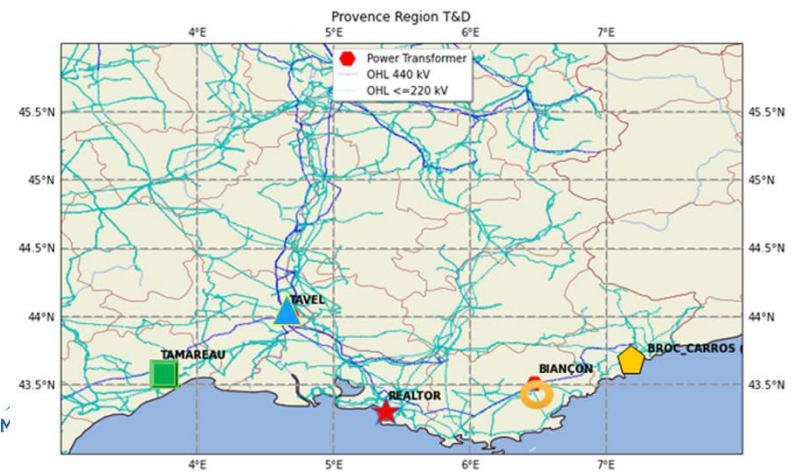

RESULTS : POWER GRID TRANSMISSION CAPACITY

QUASI-DYNAMIC THERMAL RATINGS

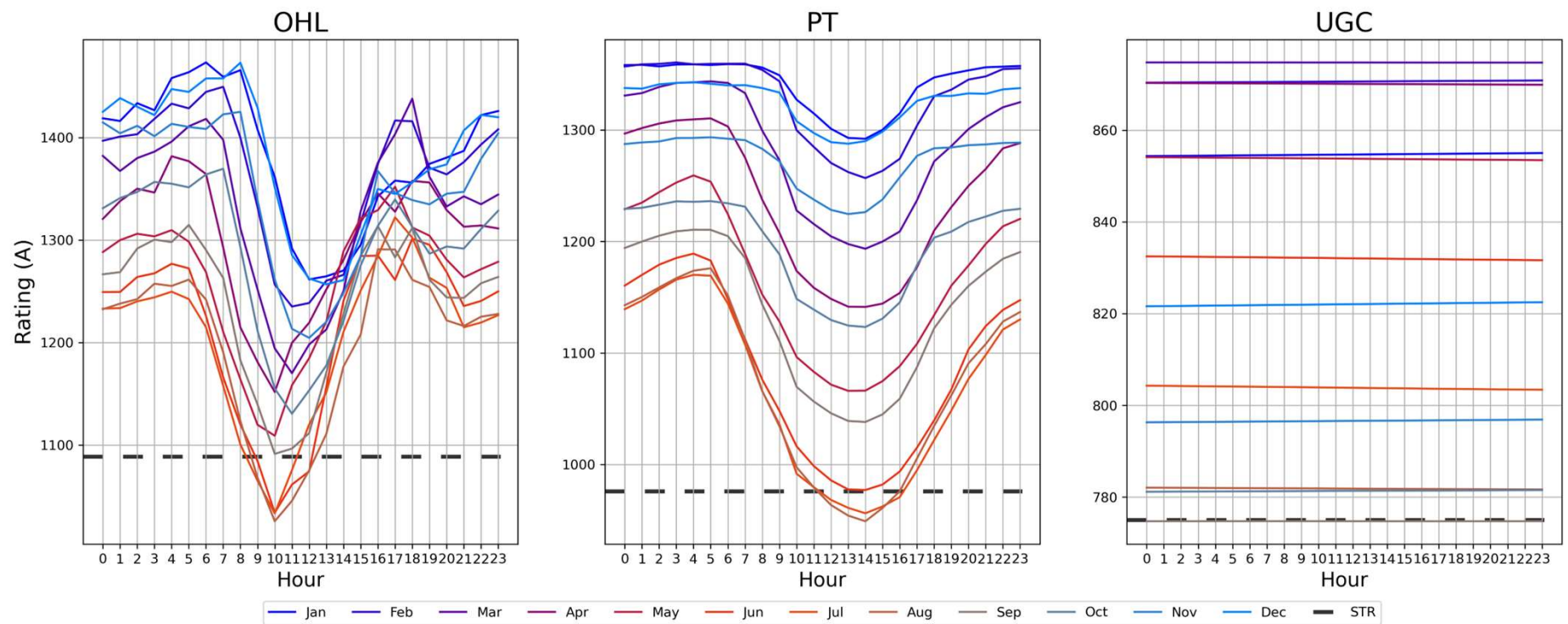

RESULTS : CLIMATE IMPACT (1972 TO 2072)

Table 1 Variation for the three scenarios with respect to historical values for qDTR for the European region.

Description	Component		
	OHL	PT	UGC
$\Delta\%(qDTR_H, STR_H)^1$			
Mean	14.2	17.4	3.74
$\Delta\%(qDTR_H)^2$			
Max	10.7	17.4	29.6
Min	-9.4	-16.4	-57.8
$\Delta\%(STR_{RCP}, STR_H)^3$			
2.6	-0.5	-1.3	-0.1
4.5	-0.9	-2.6	-0.2
8.5	-0.5	-3.7	-0.2
$\Delta\%(qDTR_{RCP2.6}, qDTR_H)^3$			
Mean	-0.4	-1.0	-0.1
Max	-1.4	-2.4	-0.5
Min	0.75	0.3	0.8
$\Delta\%(qDTR_{RCP4.5}, qDTR_H)^3$			
Mean	-0.7	-1.7	-0.2
Max	-1.7	-3.2	-0.6
Min	0.9	-0.6	0.5
$\Delta\%(qDTR_{RCP8.5}, qDTR_H)^3$			
Mean	-1.53	-2.3	-0.2
Max	-3.9	-5.1	-1
Min	0.32	-0.8	1.0

¹The average additional transmission capacity provided by qDTR in place of STR, calculated from historical data.
²The spatial variation on the continent of qDTR, calculated from historical data.
³The variation of transmission capacity calculated with the specific climatic scenario versus historical weather

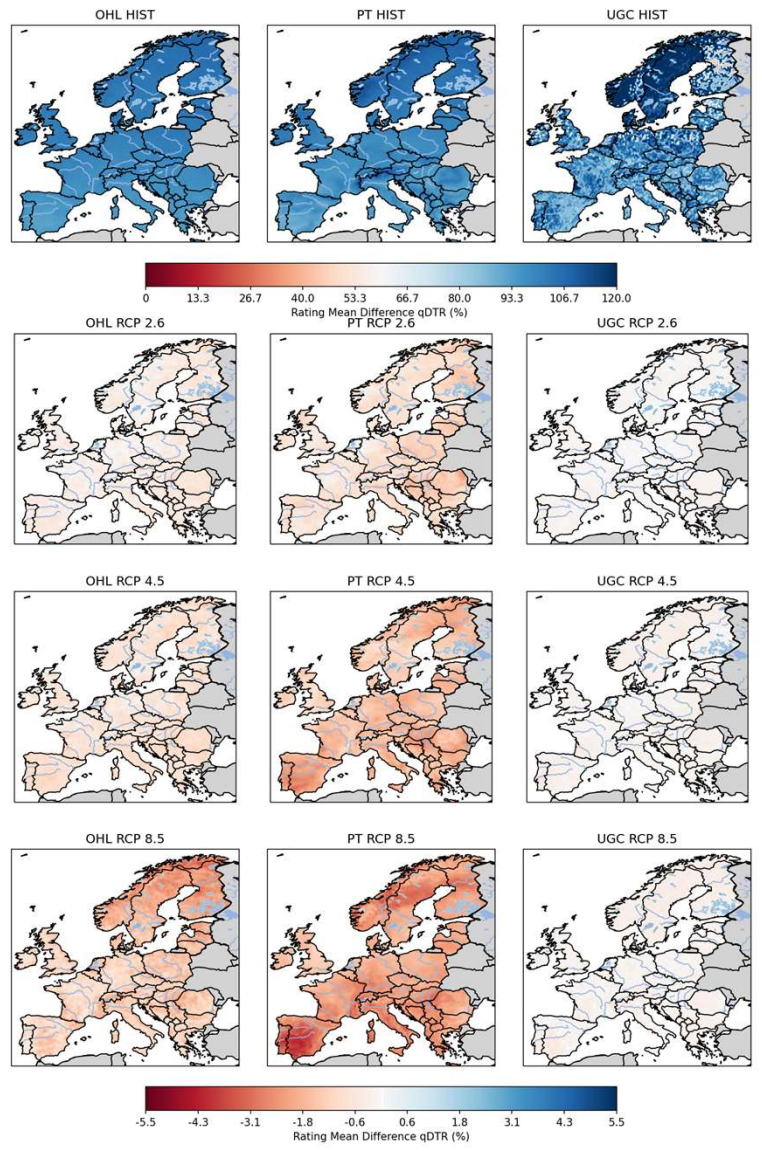

RESULTS : CLIMATE IMPACT (1972 TO 2072)

Reduce Capacity ■ Enhance ■

Table 1 Variation for the three scenarios with respect to historical values for qDTR for the European region.

Description	Component		
	OHL	PT	UGC
$\Delta\%(qDTR_H, STR_H)^1$			
Mean	14.2	17.4	3.74
$\Delta\%(qDTR_H)^2$			
Max	10.7	17.4	29.6
Min	-9.4	-16.4	-57.8
$\Delta\%(STR_{RCP}, STR_H)^3$			
2.6	-0.5	-1.3	-0.1
4.5	-0.9	-2.6	-0.2
8.5	-0.5	-3.7	-0.2
$\Delta\%(qDTR_{RCP2.6}, qDTR_H)^3$			
Mean	-0.4	-1.0	-0.1
Max	-1.4	-2.4	-0.5
Min	0.75	0.3	0.8
$\Delta\%(qDTR_{RCP4.5}, qDTR_H)^3$			
Mean	-0.7	-1.7	-0.2
Max	-1.7	-3.2	-0.6
Min	0.9	-0.6	0.5
$\Delta\%(qDTR_{RCP8.5}, qDTR_H)^3$			
Mean	-1.53	-2.3	-0.2
Max	-3.9	-5.1	-1
Min	0.32	-0.8	1.0

¹The average additional transmission capacity provided by qDTR in place of STR, calculated from historical data.
²The spatial variation on the continent of qDTR, calculated from historical data.
³The variation of transmission capacity calculated with the specific climatic scenario versus historical weather

Enhanced Transmission Capacity Probabilistic Dynamic Rating

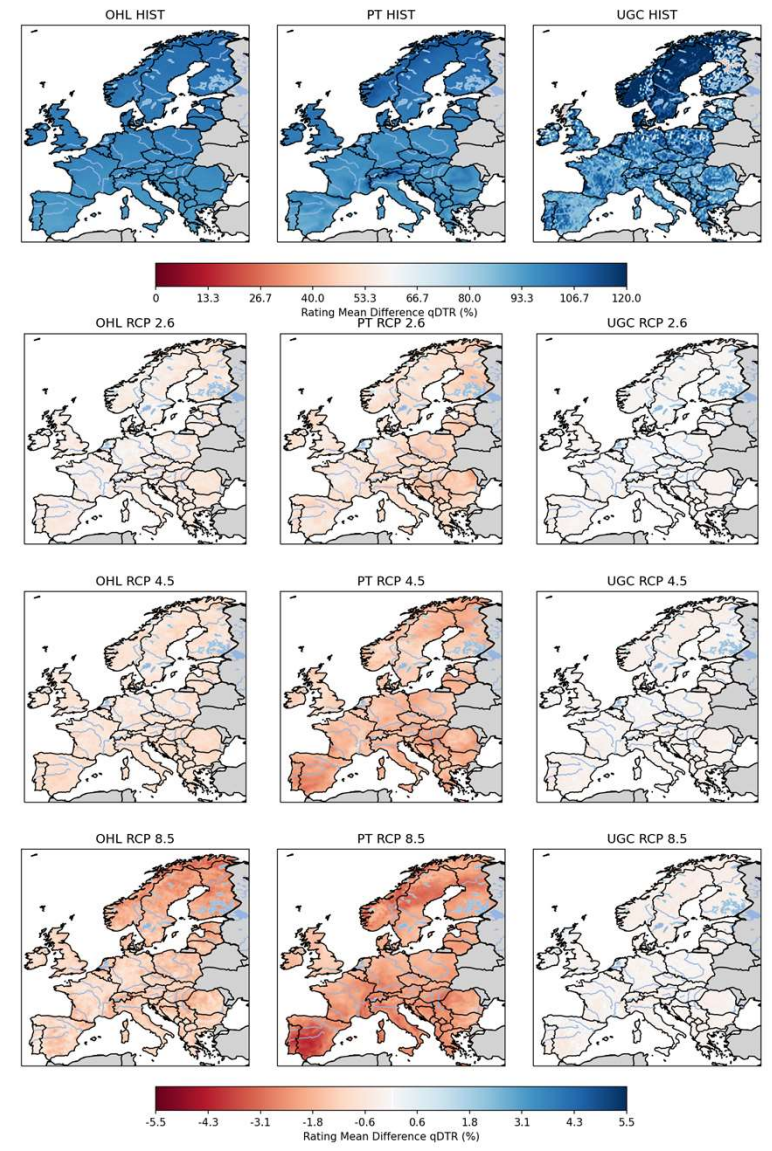

RESULTS : CLIMATE IMPACT (1972 TO 2072)

Seasonality

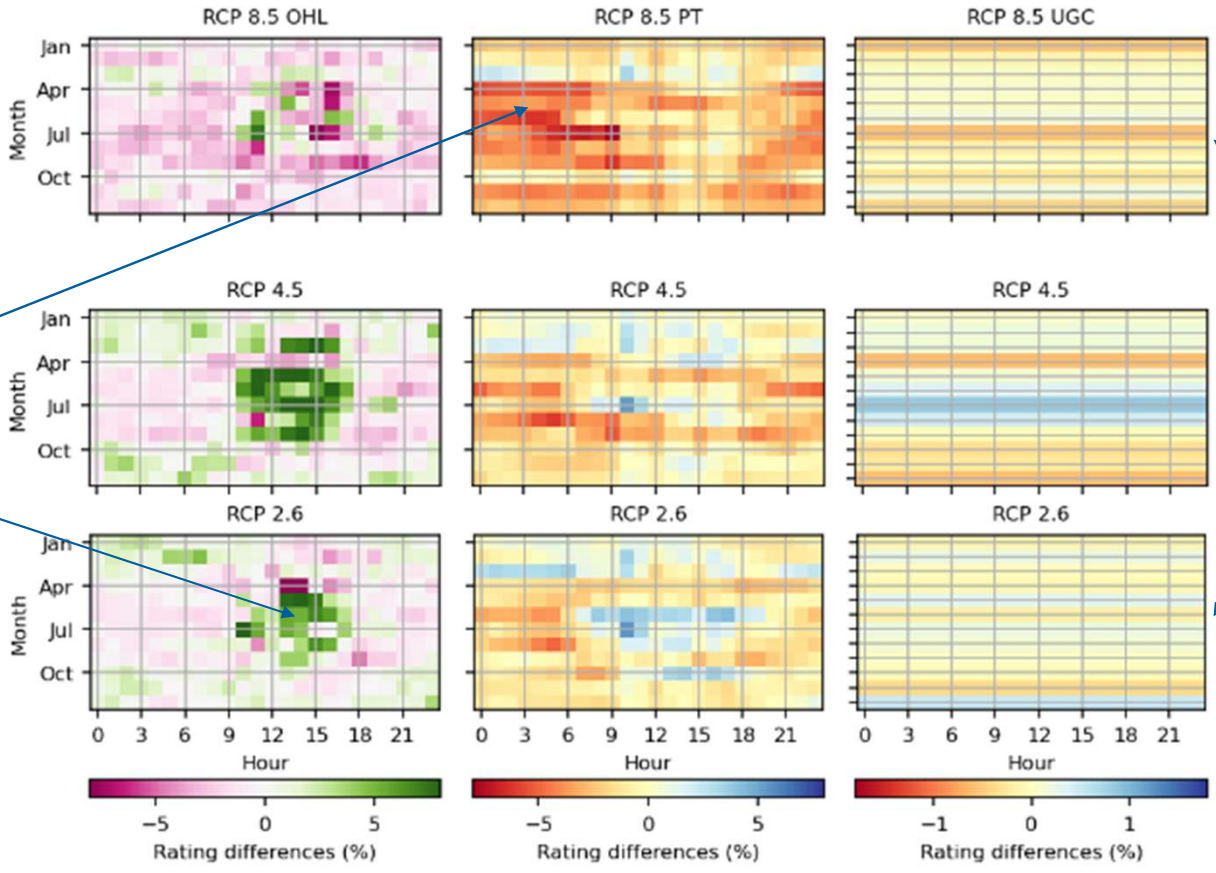

Inertia - Monthly rate change of less than 5%.

Develop thermal ratings for PSC based on climatic factors.

RESULTS : CLIMATE IMPACT (1972 TO 2072)

Table 1 Variation for the three scenarios with respect to historical values for qDTR for the European region.

Description	Component		
	OHL	PT	UGC
$\Delta\%(qDTR_H, STR_H)^1$			
Mean	14.2	17.4	3.74
$\Delta\%(qDTR_H)^2$			
Max	10.7	17.4	29.6
Min	-9.4	-16.4	-57.8
$\Delta\%(STR_{RCP}, STR_H)^3$			
2.6	-0.5	-1.3	-0.1
4.5	-0.9	-2.6	-0.2
8.5	-0.5	-3.7	-0.2
$\Delta\%(qDTR_{RCP2.6}, qDTR_H)^3$			
Mean	-0.4	-1.0	-0.1
Max	-1.4	-2.4	-0.5
Min	0.75	0.3	0.8
$\Delta\%(qDTR_{RCP4.5}, qDTR_H)^3$			
Mean	-0.7	-1.7	-0.2
Max	-1.7	-3.2	-0.6
Min	0.9	-0.6	0.5
$\Delta\%(qDTR_{RCP8.5}, qDTR_H)^3$			
Mean	-1.53	-2.3	-0.2
Max	-3.9	-5.1	-1
Min	0.32	-0.8	1.0

¹The average additional transmission capacity provided by qDTR in place of STR, calculated from historical data.
²The spatial variation on the continent of qDTR, calculated from historical data.
³The variation of transmission capacity calculated with the specific climatic scenario versus historical weather

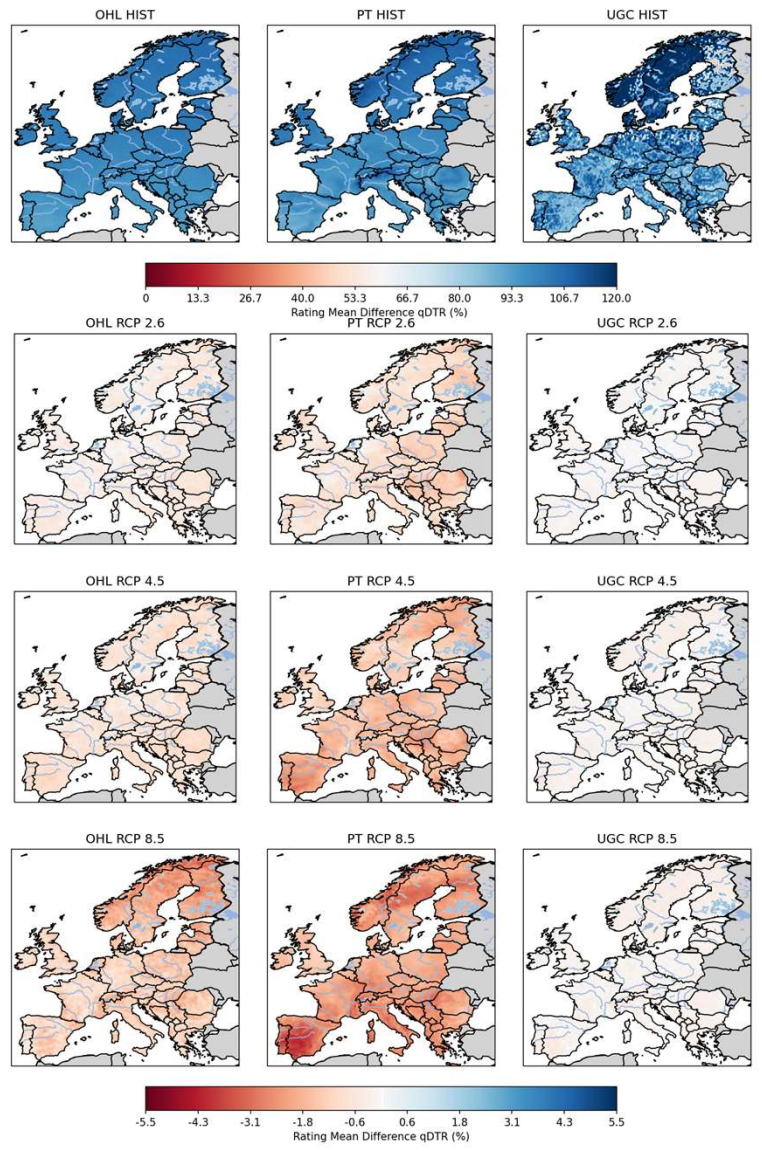

5.2 How can the DTR be included in PSP?

RESULTS : CLIMATE IMPACT

The Climate Change Impact on Power Grid Transmission Capacity

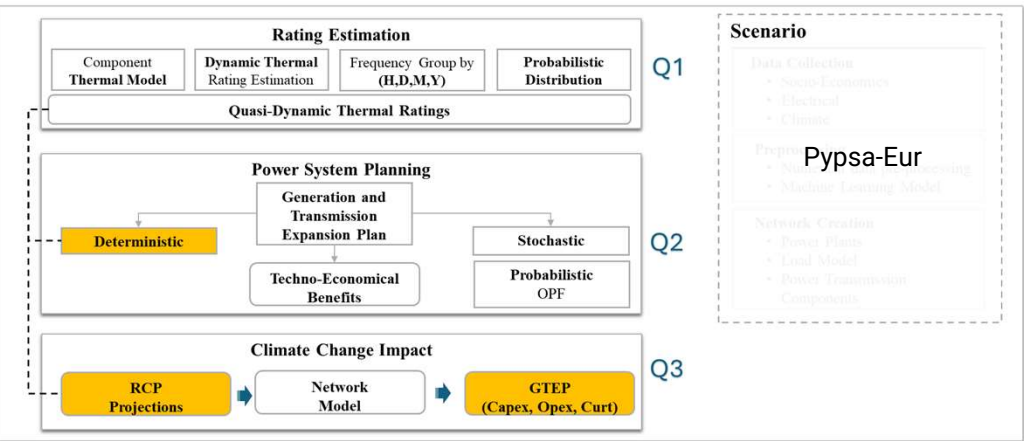
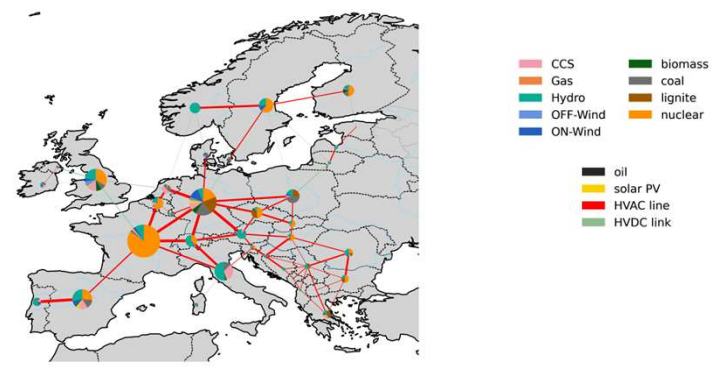

Included the Dynamic Thermal limit in a deterministic - GTEP

Capacity Expansion Planning with pypsa — Data Science for Energy System Modelling (fneum.github.io)

RESULTS : CLIMATE IMPACT

The Climate Change Impact on Power Grid Transmission Capacity

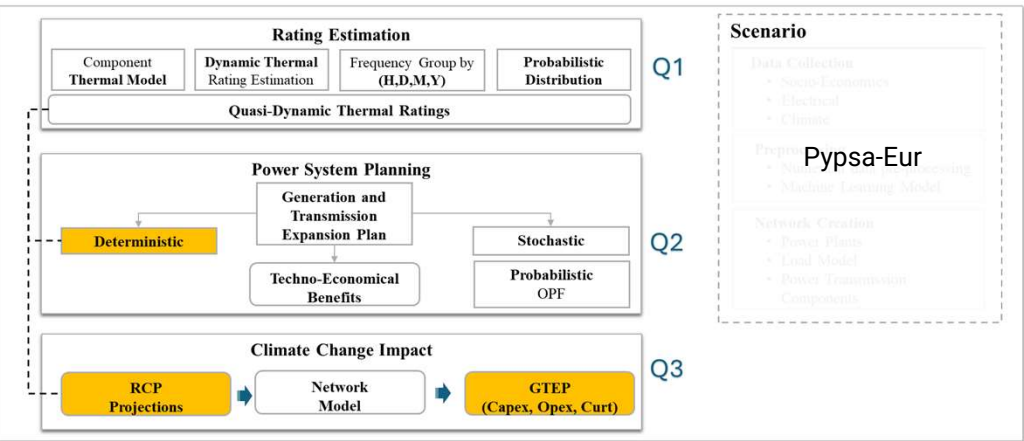
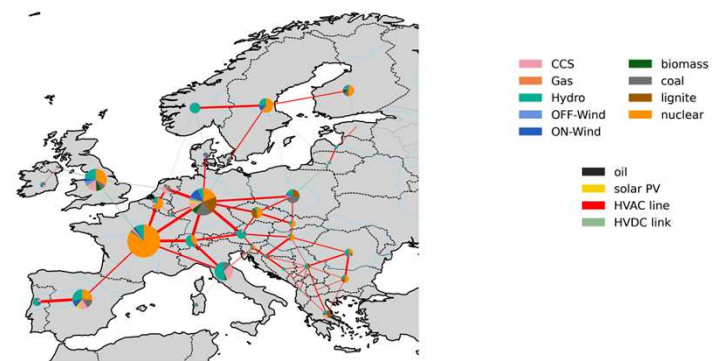

Included the Dynamic Thermal limit in a deterministic - GTEP

Table 2 Variation (in %) for the three scenarios with respect to yearly fix rating and costs, the scenarios covering historical static (STR_H), historical (qDTR_H) and projected (qDTR_{RCP})

SCENARIO	EUROPE			FRANCE			
	RCP	2.6	4.5	8.5	2.6	4.5	8.5
STR _H	CAPEX (B€)	3.55E+2	3.55E+2	3.55E+2	6.65E+1	6.65E+1	6.65E+1
	OPEX (B€)	1.89E+1	1.89E+1	1.89E+1	3.17E+0	3.17E+0	3.17E+0
	System Cost (B€)	4.00E+2	4.00E+2	4.00E+2	7.39E+1	7.39E+1	7.39E+1
	LCOE (€/MWh)	2.77E+1	2.77E+1	2.77E+1	3.53E+1	3.53E+1	3.53E+1
	Curtailment (GW)	7.32E+0	7.30E+0	7.32E+0	1.53E-1	1.54E-1	1.60E-1
Δ(STR _{RCP} , STR _H)	CAPEX (%)	-4.99E-4	-5.16E-3	-1.59E-3	1.12E-3	1.99E-4	-2.37E-3
	OPEX (%)	1.70E-2	4.71E-3	1.26E-2	-6.06E-2	-5.71E-2	-1.60E-2
	System Cost (%)	1.45E-3	-4.06E-3	-7.96E-6	-5.09E-3	-5.57E-3	-3.80E-3
	LCOE (%)	1.45E-3	-4.06E-3	-7.96E-6	-5.09E-3	-5.57E-3	-3.80E-3
	Curtailment (%)	2.57E-1	-5.04E-1	-3.01E-1	6.67E+0	-1.75E+0	9.59E-1
Δ(qDTR _{RCP} , STR _H)	CAPEX (%)	2.32E-2	1.42E-2	2.41E-2	1.78E-2	1.51E-2	1.85E-2
	OPEX (%)	1.44E-1	1.36E-1	1.32E-1	-1.87E-1	-1.99E-1	-1.97E-1
	System Cost (%)	3.66E-2	2.77E-2	3.60E-2	-2.73E-3	-6.41E-3	-3.18E-3
	LCOE (%)	3.66E-2	2.77E-2	3.60E-2	-2.73E-3	-6.41E-3	-3.18E-3
	Curtailment (%)	6.49E-1	8.45E-3	4.26E-1	-2.66E-1	5.99E-1	6.77E+0
Δ(qDTR _{RCP} / H)	CAPEX (%)	-6.26E-3	4.59E+0	-1.20E-2	-2.03E-3	4.75E-3	9.08E-4
	OPEX (%)	4.88E-3	2.20E+1	1.68E-2	1.30E-2	-3.36E-2	5.95E-3
	System Cost (%)	-5.02E-3	6.52E+0	-8.81E-3	-5.19E-4	8.76E-4	1.42E-3
	LCOE (%)	-5.02E-3	6.52E+0	-8.81E-3	-5.19E-4	8.76E-4	1.42E-3
	Curtailment (%)	4.57E-2	4.20E-1	-6.10E-2	-1.20E+0	3.64E+0	-2.13E+0
Δ(qDTR _{RCP} , STR _R)	CAPEX (%)	1.70E-2	4.61E+0	1.21E-2	1.58E-2	1.99E-2	1.94E-2
	OPEX (%)	1.49E-1	2.21E+1	1.49E-1	-1.74E-1	-2.32E-1	-1.91E-1
	System Cost (%)	3.16E-2	6.55E+0	2.72E-2	-3.25E-3	-5.53E-3	-1.76E-3
	LCOE (%)	3.16E-2	6.55E+0	2.72E-2	-3.25E-3	-5.53E-3	-1.76E-3
	Curtailment (%)	6.94E-1	4.28E-1	3.65E-1	-1.47E+0	4.21E+0	4.79E+0

RESULTS : CLIMATE IMPACT

The Climate Change Impact on Power Grid Transmission Capacity

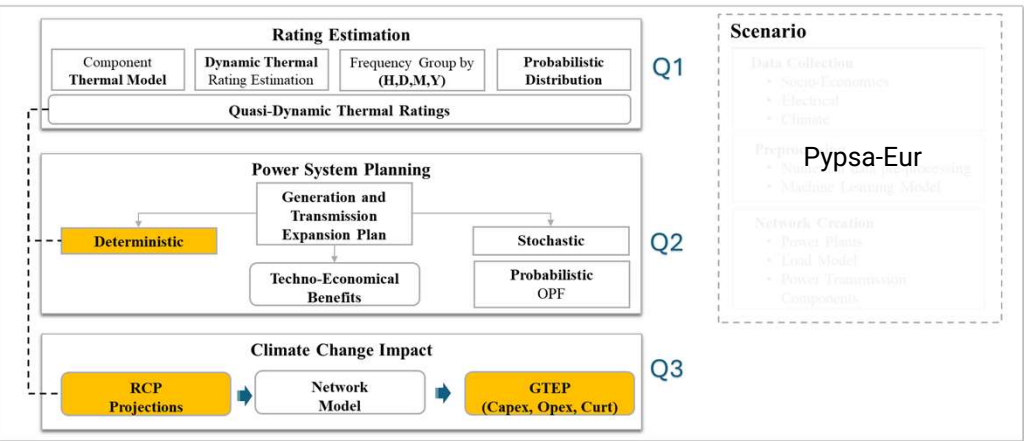
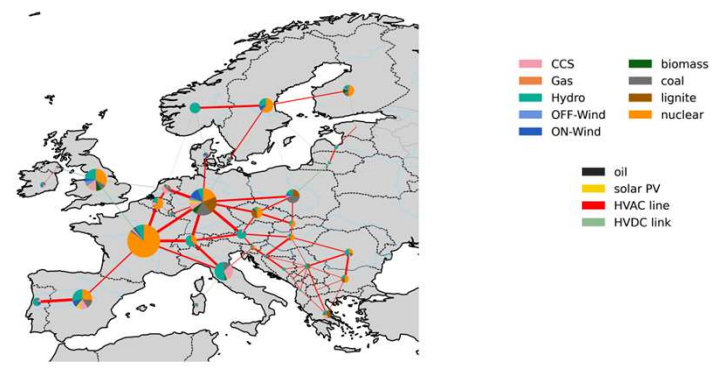

Included the Dynamic Thermal limit in a deterministic - GTEP

Table 2 Variation (in %) for the three scenarios with respect to yearly fix rating and costs, the scenarios covering historical static (STR_H), historical (qDTR_H) and projected (qDTR_{RCP})

SCENARIO	EUROPE			FRANCE			
	RCP	2.6	4.5	8.5	2.6	4.5	8.5
STR _H	CAPEX (B€)	3.55E+2	3.55E+2	3.55E+2	6.65E+1	6.65E+1	6.65E+1
	OPEX(B€)	1.89E+1	1.89E+1	1.89E+1	3.17E+0	3.17E+0	3.17E+0
	System Cost(B€)	4.00E+2	4.00E+2	4.00E+2	7.39E+1	7.39E+1	7.39E+1
	LCOE(€/MWh)	2.77E+1	2.77E+1	2.77E+1	3.53E+1	3.53E+1	3.53E+1
	Curtaiment (GW)	7.32E+0	7.30E+0	7.32E+0	1.53E-1	1.54E-1	1.60E-1
Δ(STR _{RCP} , STR _H)	CAPEX (%)	-4.99E-4	-5.16E-3	-1.59E-3	1.12E-3	1.99E-4	-2.37E-3
	OPEX (%)	1.70E-2	4.71E-3	1.26E-2	-6.06E-2	-5.71E-2	-1.60E-2
	System Cost (%)	1.45E-3	-4.06E-3	-7.96E-6	-5.09E-3	-5.57E-3	-3.80E-3
	LCOE(%)	1.45E-3	-4.06E-3	-7.96E-6	-5.09E-3	-5.57E-3	-3.80E-3
	Curtaiment (%)	2.57E-1	-5.04E-1	-3.01E-1	6.67E+0	-1.75E+0	9.59E-1
Δ(qDTR _{RCP} , STR _H)	CAPEX (%)	2.32E-2	1.42E-2	2.41E-2	1.78E-2	1.51E-2	1.85E-2
	OPEX(%)	1.44E-1	1.36E-1	1.32E-1	-1.87E-1	-1.99E-1	-1.97E-1
	System Cost (%)	3.66E-2	2.77E-2	3.60E-2	-2.73E-3	-6.41E-3	-3.18E-3
	LCOE(%)	3.66E-2	2.77E-2	3.60E-2	-2.73E-3	-6.41E-3	-3.18E-3
	Curtaiment (%)	6.49E-1	8.45E-3	4.26E-1	-2.66E-1	5.99E-1	6.77E+0
Δ(qDTR _{RCP} / R)	CAPEX (%)	-6.26E-3	4.59E+0	-1.20E-2	-2.03E-3	4.75E-3	9.08E-4
	OPEX (%)	4.88E-3	2.20E+1	1.68E-2	1.30E-2	-3.36E-2	5.95E-3
	System Cost (%)	-5.02E-3	6.52E+0	-8.81E-3	-5.19E-4	8.76E-4	1.42E-3
	LCOE(%)	-5.02E-3	6.52E+0	-8.81E-3	-5.19E-4	8.76E-4	1.42E-3
	Curtaiment (%)	4.57E-2	4.20E-1	-6.10E-2	-1.20E+0	3.64E+0	-2.13E+0
Δ(qDTR _{RCP} , STR _R)	CAPEX (%)	1.70E-2	4.61E+0	1.21E-2	1.58E-2	1.99E-2	1.94E-2
	OPEX (%)	1.49E-1	2.21E+1	1.49E-1	-1.74E-1	-2.32E-1	-1.91E-1
	System Cost (%)	3.16E-2	6.55E+0	2.72E-2	-3.25E-3	-5.53E-3	-1.76E-3
	LCOE(%)	3.16E-2	6.55E+0	2.72E-2	-3.25E-3	-5.53E-3	-1.76E-3
	Curtaiment (%)	6.94E-1	4.28E-1	3.65E-1	-1.47E+0	4.21E+0	4.79E+0

← RCP

Impact of the use of qDTR

Impact of the Climate

Reduce ■ Increase ■

RESULTS : CLIMATE IMPACT

Assessing Regional Capacity Expansion: The Role of Quasi-Dynamic Thermal Ratings in a Changing Climate

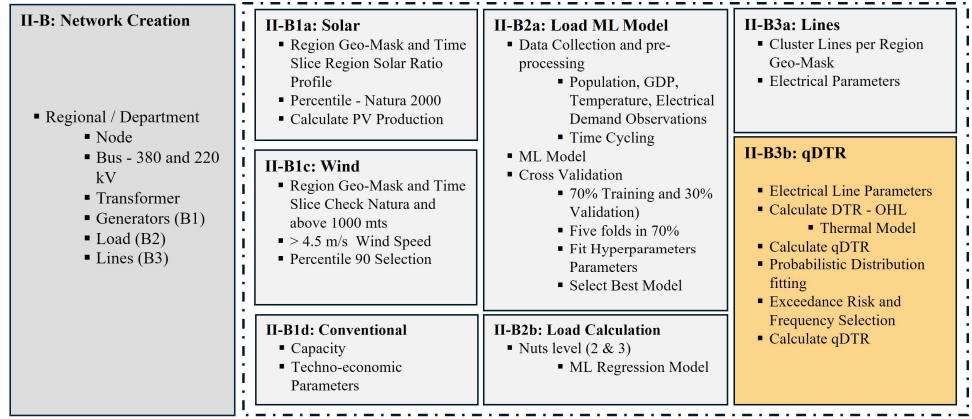
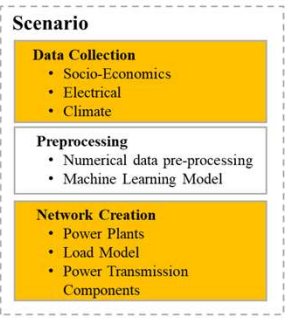
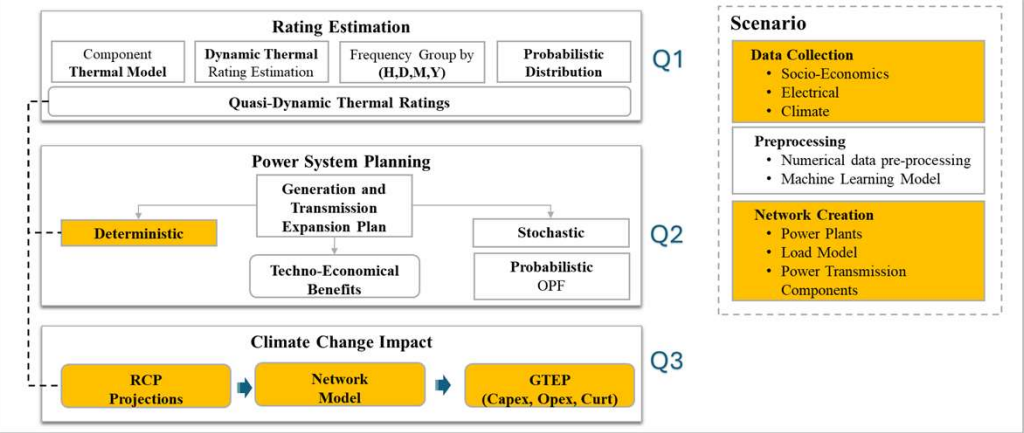
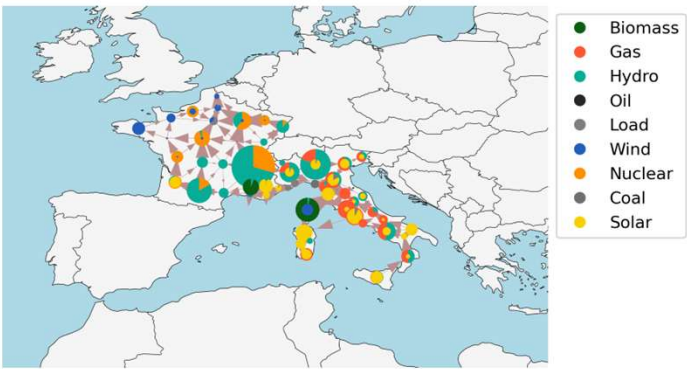

Included the Dynamic Thermal limit in a deterministic - GTEP

RESULTS : CLIMATE IMPACT

Assessing Regional Capacity Expansion: The Role of Quasi-Dynamic Thermal Ratings in a Changing Climate

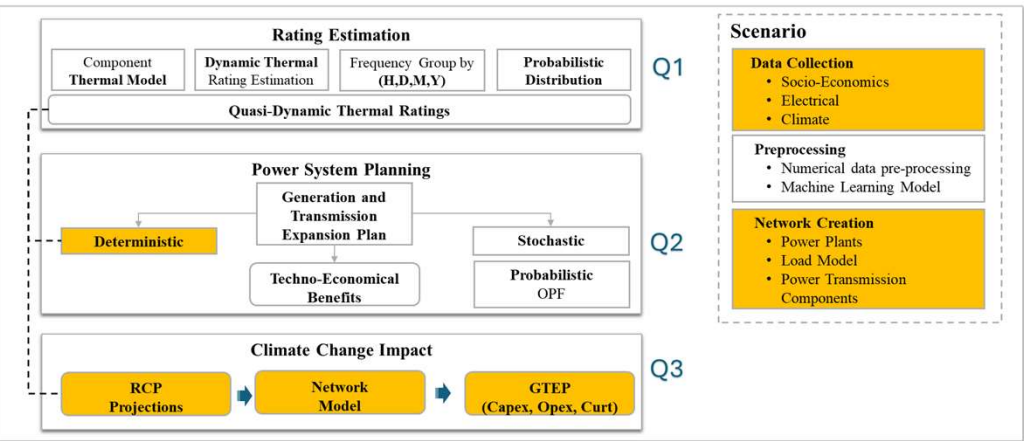
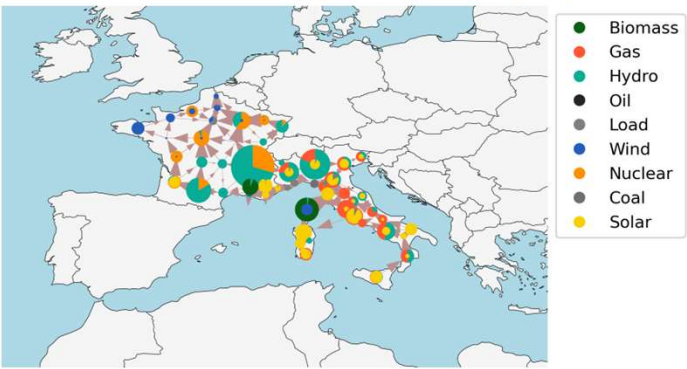

TABLE IV
VARIATION (IN %) FOR THE THREE SCENARIOS CONCERNING YEARLY FIX RATING AND COSTS

	RCP _{8.5} ,STR	RCP _{4.5} ,STR	RCP _{2.6} ,STR
CAPEX			
Renewable	-1	-2	-1.8
Fossil	-2	-1	-2
Nuclear	0	0	0
Total	-1	-1	-1
OPEX			
Renewable	-3	-4.3	-3.4
Fossil	0	-1	-1
Nuclear	4	5	3
Total	-0.3	-1	-1
Curtailement	-14	-16	-17
System Cost	-0.4	-1	-1

Included the Dynamic Thermal limit in a deterministic - GTEP

Reduce

6. Discussion

CONCLUSIONS AND NEXT STEPS

Enhanced Transmission Capacity: Implementing qDTR instead of STR significantly enhances average transmission capacity across Europe. This method shows improvements of 14.2%, 17.4%, and 3.7% for overhead lines (OHL), power transformers (PT), and underground cables (UGC), respectively.

Soil Moisture Anomalies: The research validates previous findings that soil moisture anomalies exhibit a memory effect, persisting for weeks or months with a monthly rate change of less than 5%. This persistence impacts the thermal balance and, consequently, the transmission capacity.

Optimize capacity utilization: The first results of the case studies presented in this thesis and the accompanying publications have demonstrated the significant potential of DTR for RES grid integration.

Sensitivity to Climate: While geographical and technological factors influence transmission networks, capacity is susceptible to increases in ambient air temperature and fluctuating environmental factors. With higher ambient temperatures, predicted climate projections cause a reduction in power system transmission capacity in the region of 1.53%, 2.3%, and 0.2% for OHL, PT, and UGL, respectively.

Next Steps: Using the first PSP approach with Open - Tool, the overall grid costs change modestly, and the renewable curtailment is consistently reduced. The objective will be to develop the optimal formulation for the G&TEP, which will be determined by considering uncertain conditions for the demand and production scenarios.

CONCLUSIONS AND NEXT STEPS

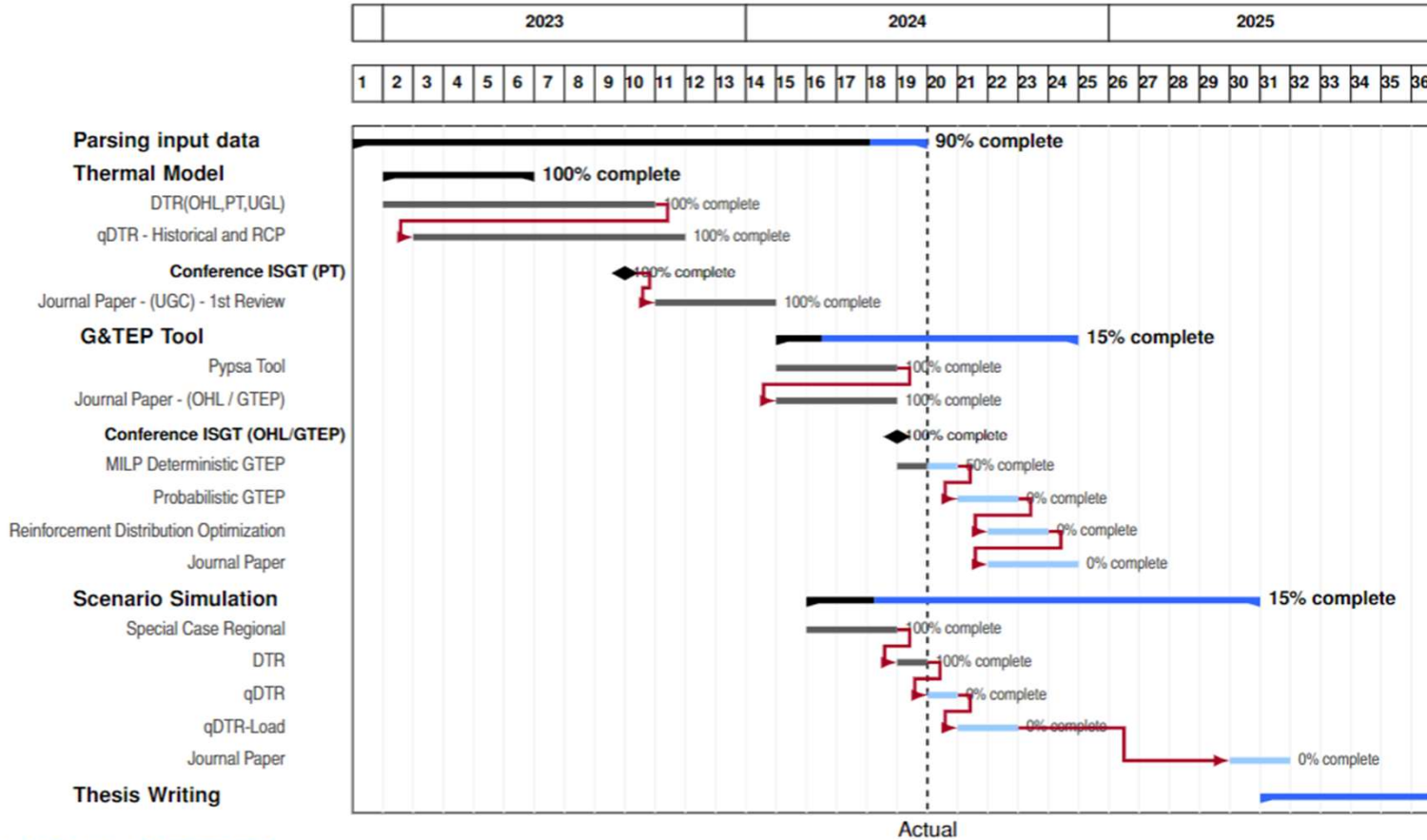

PUBLICATIONS

Montana, S., & Michiorri, A. (2024, February). Long-Term Dynamic Thermal Ratings of Underground Cables Integrating Soil Dynamics and Climate Projections. Retrieved from <https://hal.science/hal-04453943>. - Submitted / R0

Montana-Salas, S.-D., & Michiorri, A. (2023). Weather-Based Quasi Dynamic Thermal Ratings for Power Transformers. In 2023 IEEE PES Innovative Smart Grid Technologies Europe (ISGT EUROPE), Grenoble, France (pp. 1-5). - Submitted / R0

Montana Salas, S. D., & Michiorri, A. (2024). The Climate Change Impact on Power Grid Transmission Capacity. Retrieved from {hal-04453957}. In preparation

Montana Salas, S. D., & Michiorri, A. (2024). Assessing Regional Capacity Expansion: The Role of Quasi-Dynamic Thermal Ratings in a Changing Climate <https://hal.sorbonne-universite.fr/PERSEE/hal-04602860v1>. - Submitted / R0

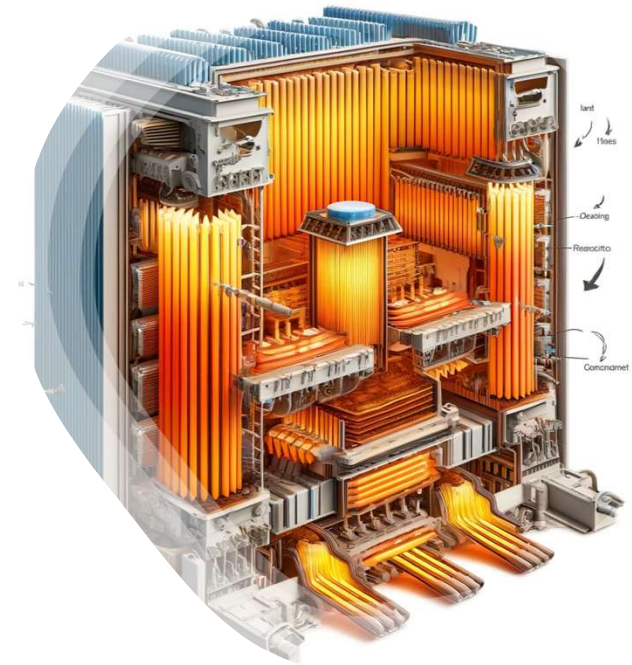

Sergio Daniel Montaña Salas
sergio-daniel.montana-salas@minesparis.psl.eu

