



HAL
open science

Experimental and numerical investigation of two-phase flow in a model of nanoporous medium

Antoine Naillon, Philippe Lefort, Sandrine Geoffroy, Marc Prat, Pierre Joseph

► **To cite this version:**

Antoine Naillon, Philippe Lefort, Sandrine Geoffroy, Marc Prat, Pierre Joseph. Experimental and numerical investigation of two-phase flow in a model of nanoporous medium. LOWPERM 2015, Jun 2015, Reuil Malmaison, France. hal-04453186

HAL Id: hal-04453186

<https://hal.science/hal-04453186>

Submitted on 12 Feb 2024

HAL is a multi-disciplinary open access archive for the deposit and dissemination of scientific research documents, whether they are published or not. The documents may come from teaching and research institutions in France or abroad, or from public or private research centers.

L'archive ouverte pluridisciplinaire **HAL**, est destinée au dépôt et à la diffusion de documents scientifiques de niveau recherche, publiés ou non, émanant des établissements d'enseignement et de recherche français ou étrangers, des laboratoires publics ou privés.



Open Archive TOULOUSE Archive Ouverte (OATAO)

OATAO is an open access repository that collects the work of Toulouse researchers and makes it freely available over the web where possible.

This is an author-deposited version published in : <http://oatao.univ-toulouse.fr/>
Eprints ID : 17337

To cite this version : Naillon, Antoine and Lefort, Philippe and Geoffroy, Sandrine and Prat, Marc and Joseph, Pierre *Experimental and numerical investigation of two-phase flow in a model of nanoporous medium*. (2015) In: LOWPERM 2015, 9 June 2015 - 11 June 2015 (Rueil-Malmaison, France). (Unpublished)

Any correspondence concerning this service should be sent to the repository administrator: staff-oatao@listes-diff.inp-toulouse.fr

Experimental and Numerical Investigation of Two Phase Flow in a Model of Nanoporous Medium

LowPerm 2015

Les rencontres scientifiques d'IFP Energies Nouvelles

Antoine Naillon^{1,2} – Philippe Lefort¹ – Sandrine Geoffroy³ – Marc Prat¹ – Pierre Joseph²

(¹ : IMFT, ² : LAAS, ³ : LMDC)

1. Motivation / Context

2. Fabrication and procedure

3. Two phase flow in dead end nanochannels

Conclusion

Repository Issue of Long Life Radioactive Wastes

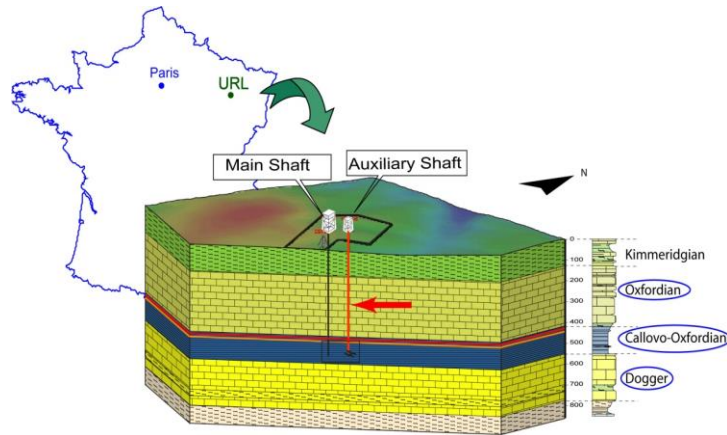

ANDRA's project of repository of long life radioactive wastes

- Specificities of this deep repository:
 - **Gas generation** (mainly H₂ from corrosion of metallic component)

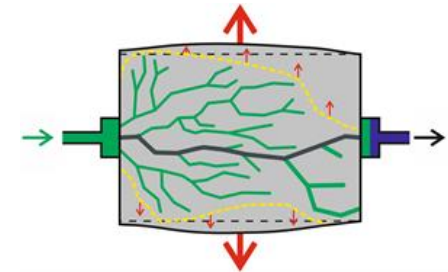

Drainage experiment of BGS

- Typical pore size : **few tens of nanometre**

- Issues:

- Influence of gas generation on fluid flow around repository galleries?

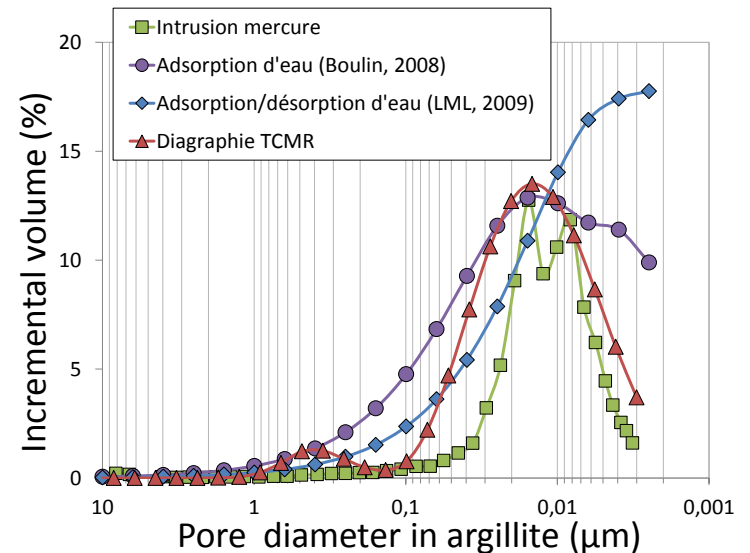

JC Robinet - ANDRA

Goals : specificities due to nanometer scale

- **Validation of hydraulic law**
 - Kinetics of imbibition

- **Effect of high capillary pressure**
 - Flow and mechanical deformation



$$P_c = \frac{2\gamma}{a} = 72 \text{ bar}$$

$$a = 20 \text{ nm}, \gamma = 72 \text{ mN/m (water)}$$

- **Modification of physical properties:**
 - Dissolution properties
 - Cavitation
 - Rarefied gas

Our approach : Nano-fabrication

- **Classical use of model system: [1]**

- Controlled geometry
- Phase visualisation
- Parallelization of experiments
- High reproducibility

- **Emergence of nanofluidics**

< 200 nm [2]

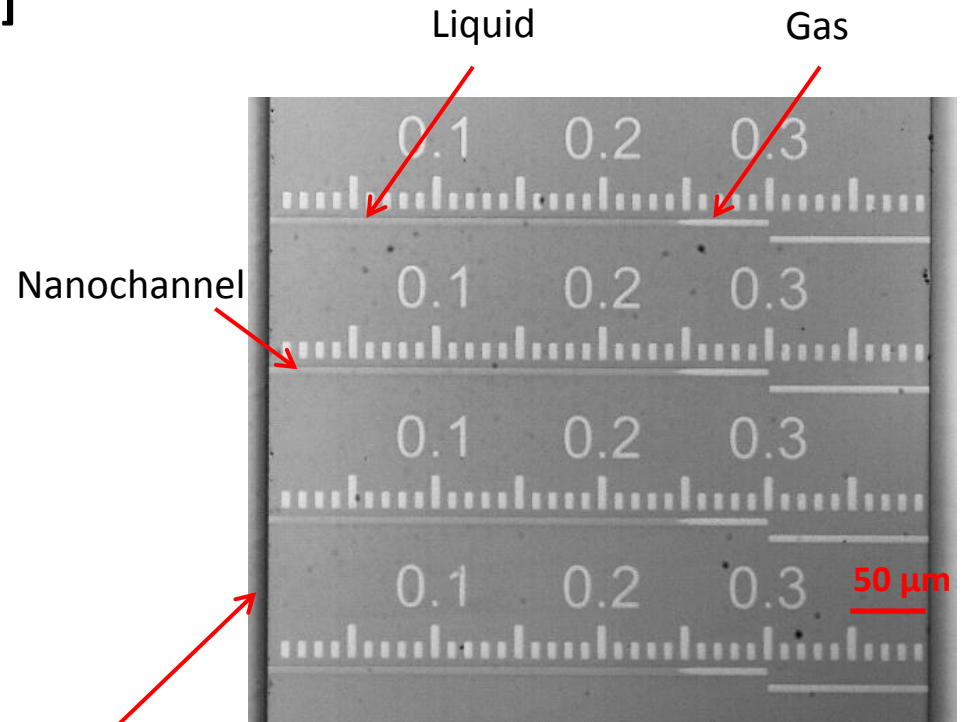

*Picture of two phase flow in dead end nano channel
(depth = 54 nm)*

[1] P. Lenormand et al., *J. Fluid Mech.* (1988)

[2] C. Duan et al., *Biomicrofluidics* (2013)

1. Motivation / Context

2. Fabrication and procedure

3. Two phase flow in dead end nanochannels

Conclusion

Nano-fabricated chip

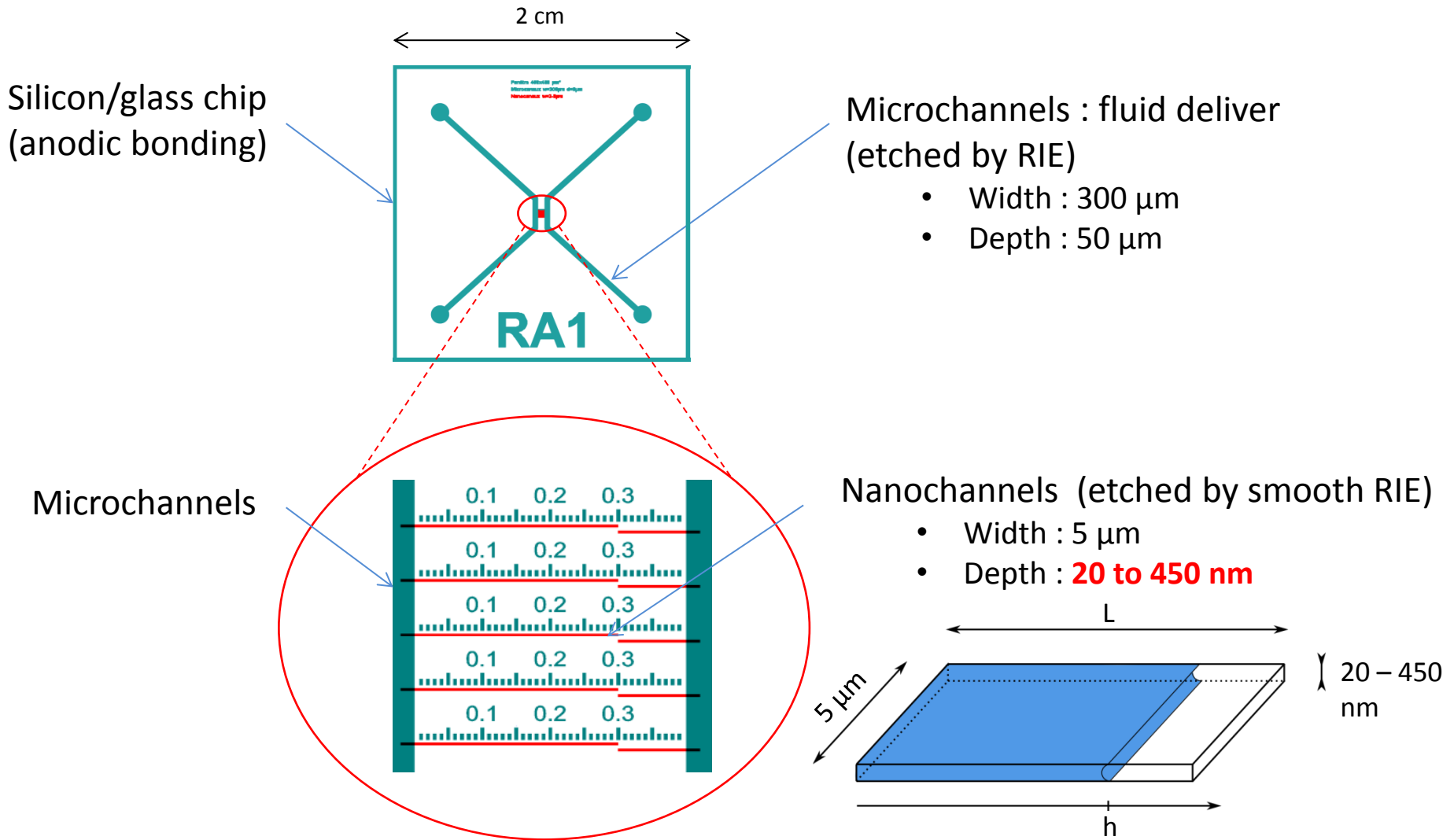

Experimental Procedure

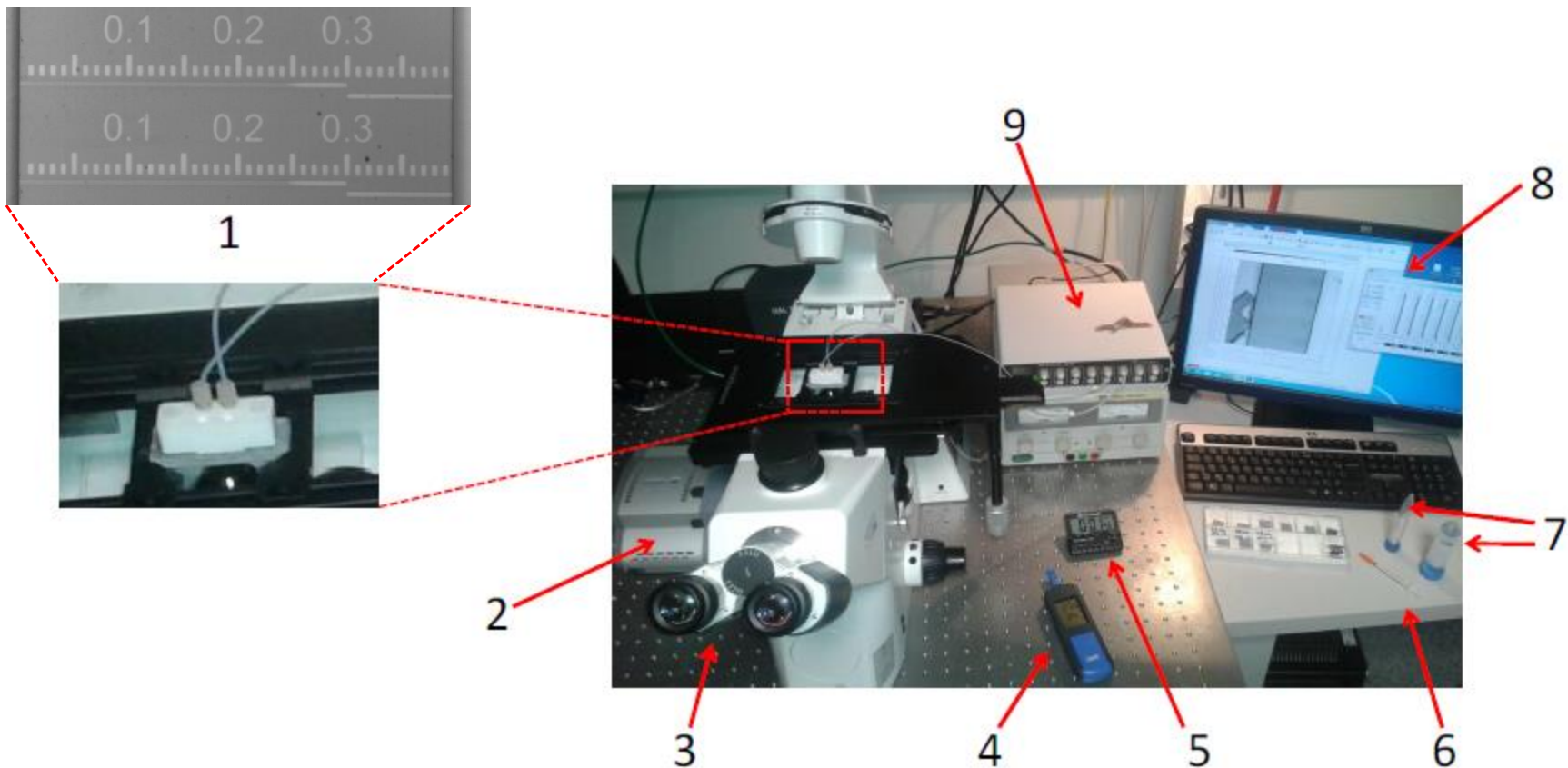

- 1. Experimental support
- 2. Video camera
- 3. Inversed microscopy

- 4. Thermo and moisture meter
- 5. Chronometer
- 6. Needle

- 7. Sample
- 8. Control screen
- 9. Pressure deliver

1. Motivation / Context

2. Fabrication and procedure

3. Two phase flow in dead end nanochannels

Conclusion

Imbibition in dead end nanochannels

- **Beginning of imbibition** => gas pressurization

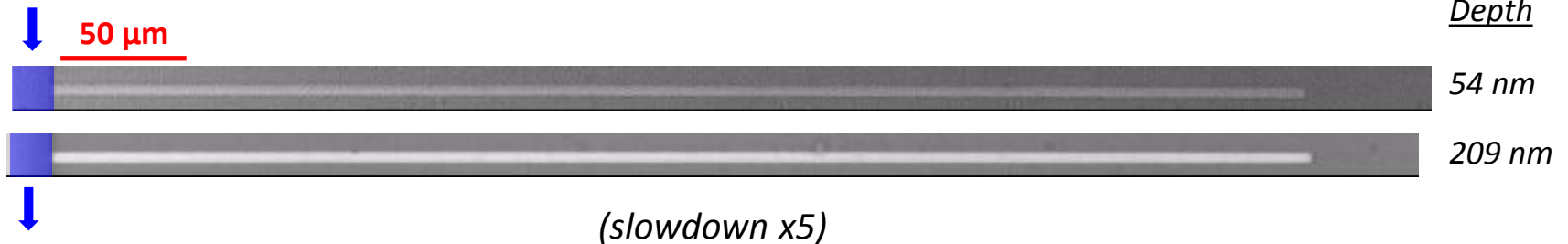
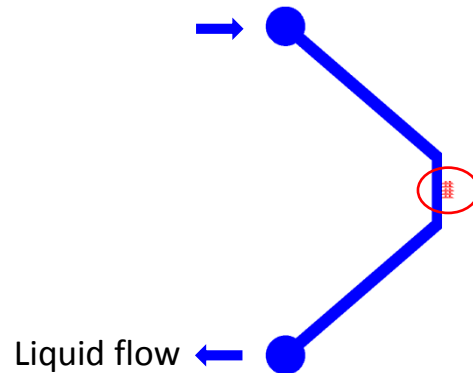
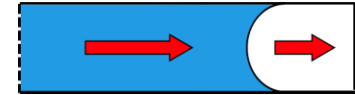

=> Meniscus dynamics is less affected at nanometer scale by gas pressurization effect

Imbibition in dead end nanochannels

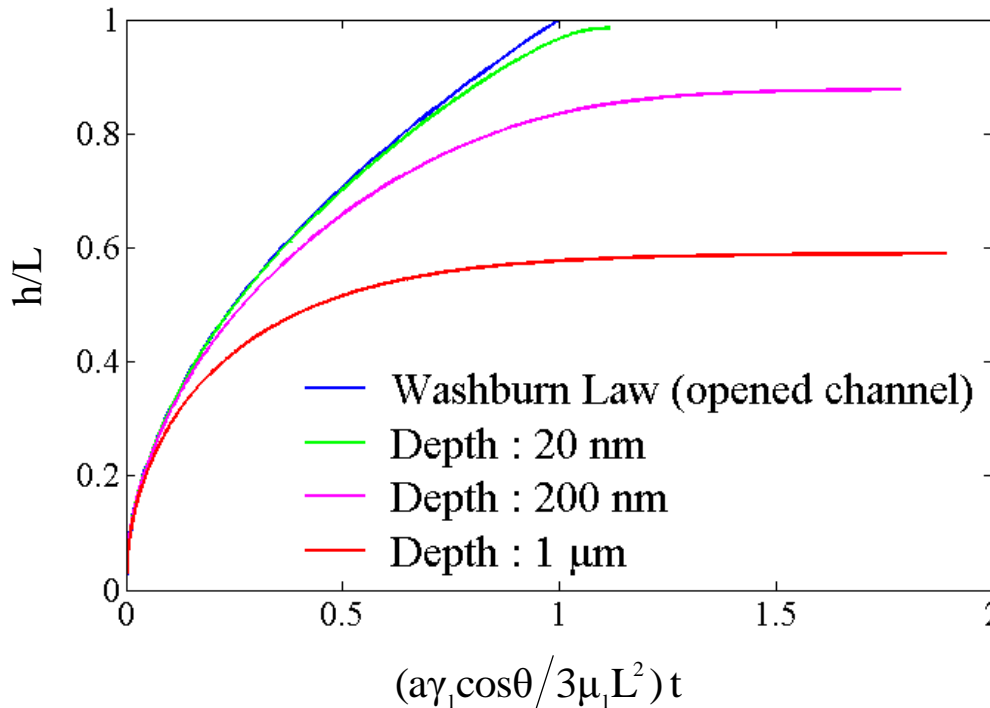

h : meniscus position

a : channel depth

L : channel length

γ_l : surface tension

μ_l : liquid viscosity

Θ : contact angle

$$\alpha = \frac{p_0}{p_{\text{cap}}}$$

Washburn law:

$$h = \sqrt{\frac{a\gamma_l \cos\theta}{3\mu_l}} t$$

Imbibition in dead end channel : (with gas compression) [1]

$$t(h) = \frac{h^2}{2(1+\alpha)} - \frac{\alpha h}{(1+\alpha)^2} - \frac{\alpha}{(1+\alpha)^3} \ln[1 - (1+\alpha)h]$$

=> Gas compression has low influence on filling kinetics for the smallest depth

[1] V.N. Phan et al., *Langmuir*, 2010

Imbibition in dead end nanochannels

- End of imbibition => gas dissolution

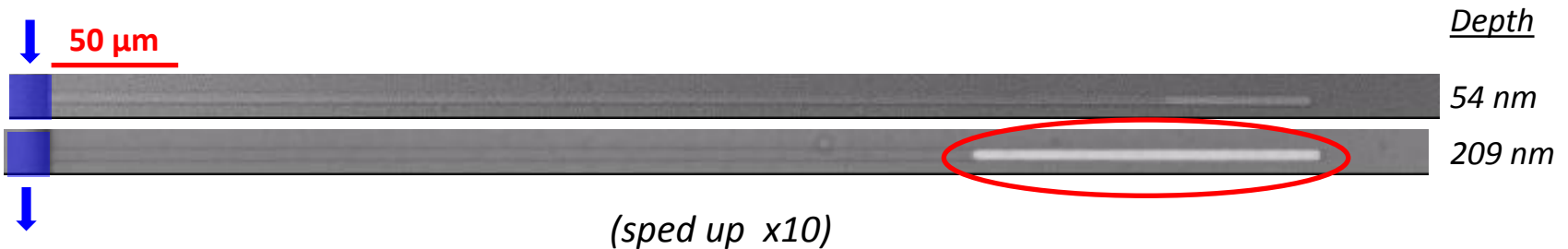
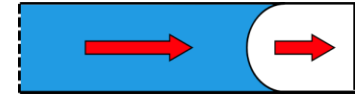

- Gas dissolution is faster for the lowest depths :
=> Higher gas concentration : $c_{eq}(\text{gas})=H \cdot P_{\text{gaz}}$
- Channel can be filled from the end !
=> end of channel is supplied by corner liquid films

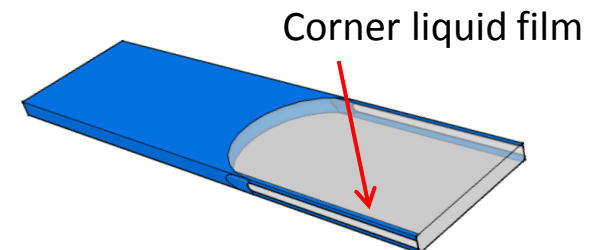

Imbibition in dead end nanochannels

- Presence of thick liquid film if walls are not strictly parallel [1]

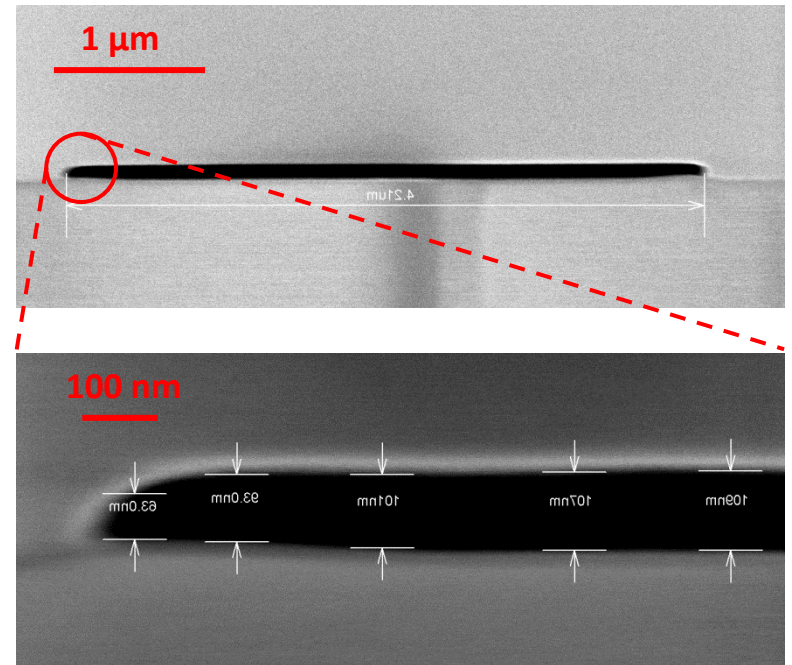
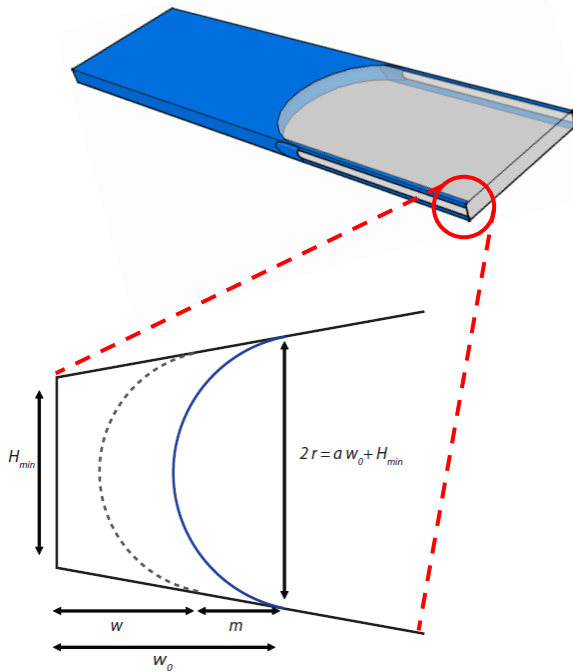

SEM imaging of nanochannels

[1] E. Keita, Thesis, 2014

Evaporation in dead end nanochannels

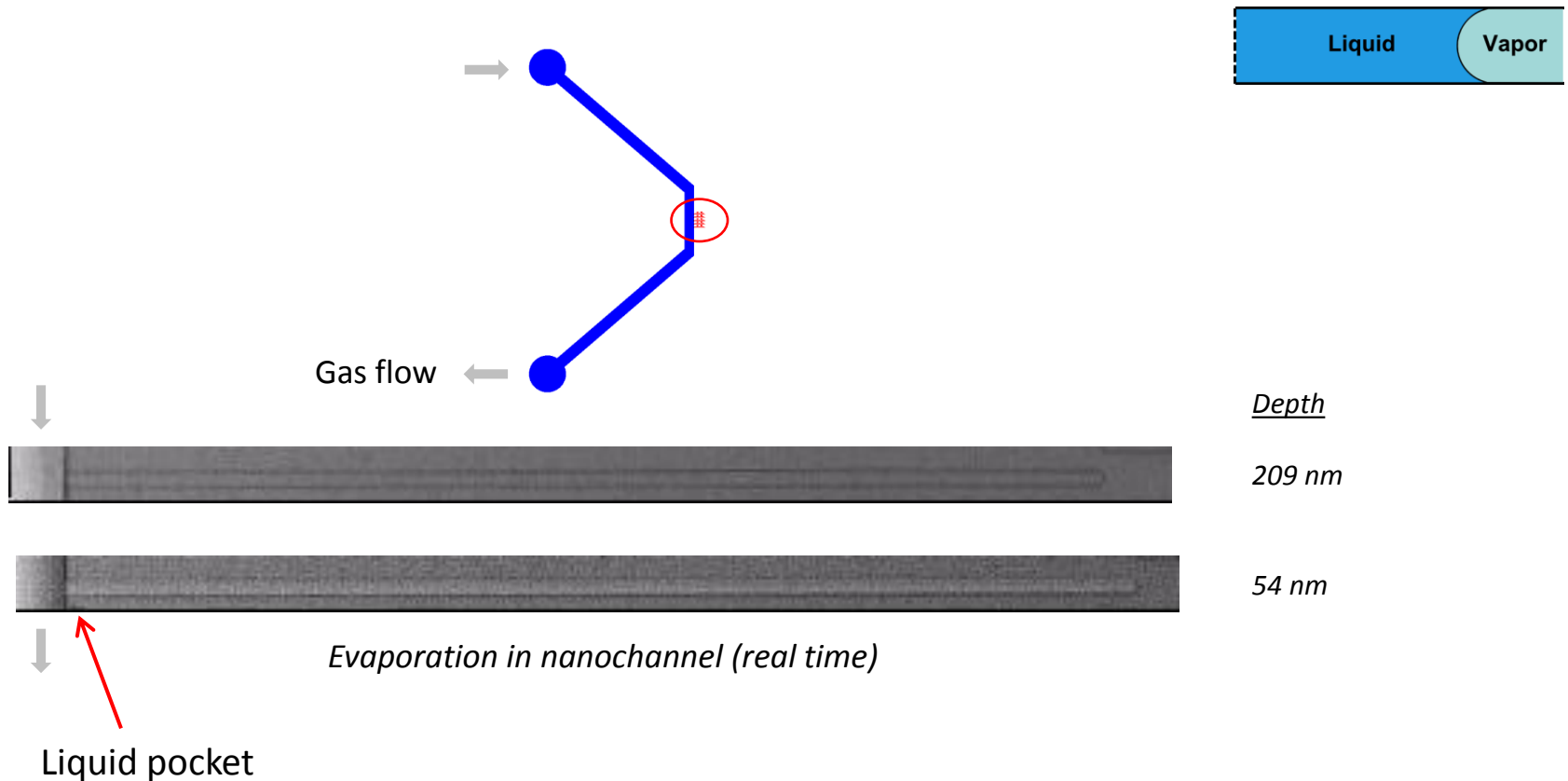

- ⇒ Presence of gas bubble modifies the kinetics of evaporation (similar in [1])
- ⇒ Evaporation from inside the liquid appears only for depth lower than 104 nm (with ethanol) (same observation as [2])

[2] C. Duan et al., *Proc. Natl. Acad. Sci. U. S. A.* (2012)

[1] O. Vincent et al., *PRL* (2014)

Conclusion

Two phase flow at nanometer scale presents particularities

High gas pressurization

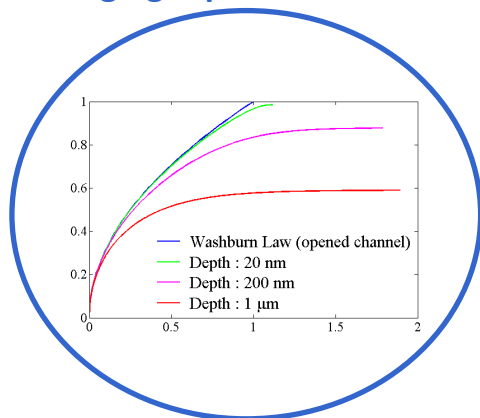

Filling from the end

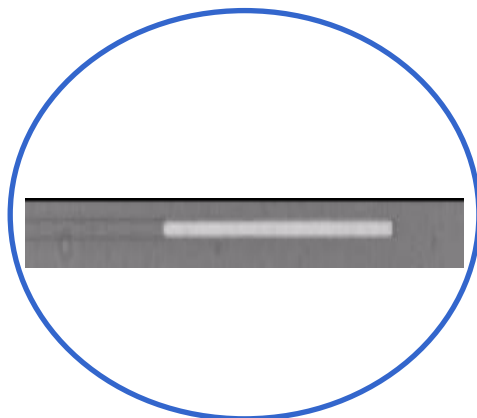

Bubbles appearance

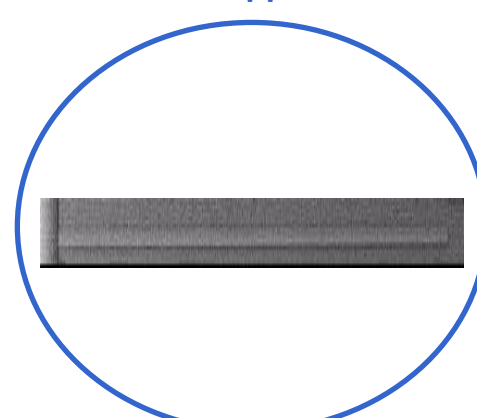

Conclusion

Two phase flow at nanometer scale presents particularities

High gas pressurization

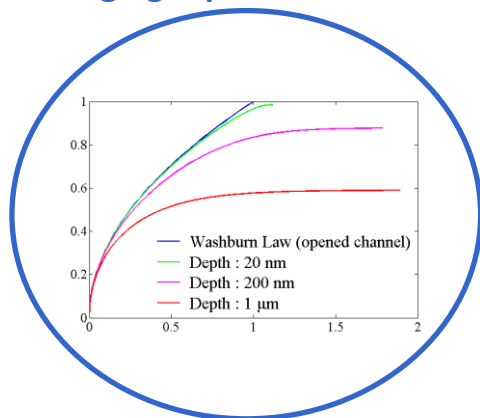

Filling from the end

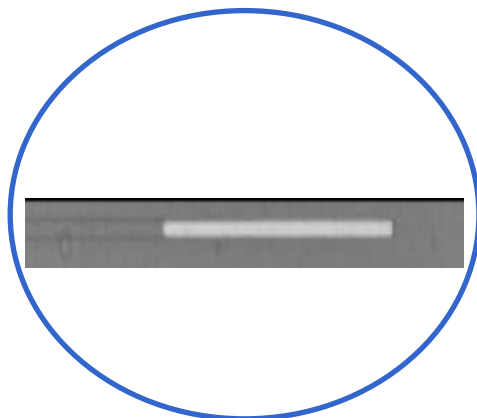

Bubbles appearance

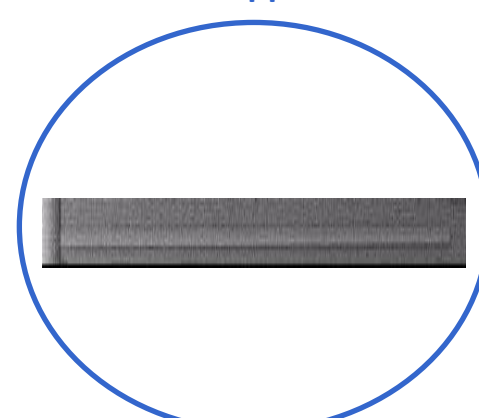

Pore size effect on crystallization

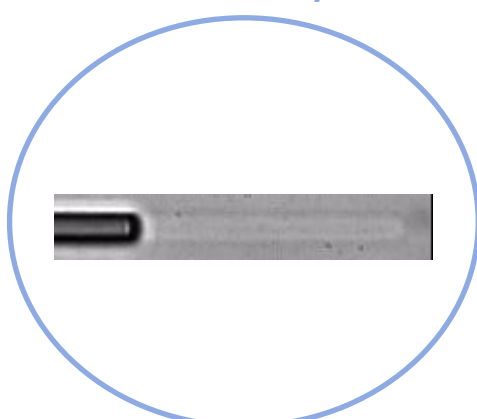

Fluid structure interaction

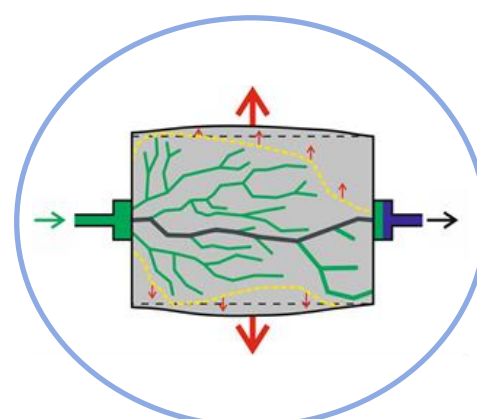

Perspective: deformable medium

- Approach of [1] and [2]
 - Simulation on pore network coupling:
 - Flow pore network (resolve by invasion percolation algorithm)
 - Spring network (elastic deformation)
- Goal = study the impact of deformation on invasion pattern

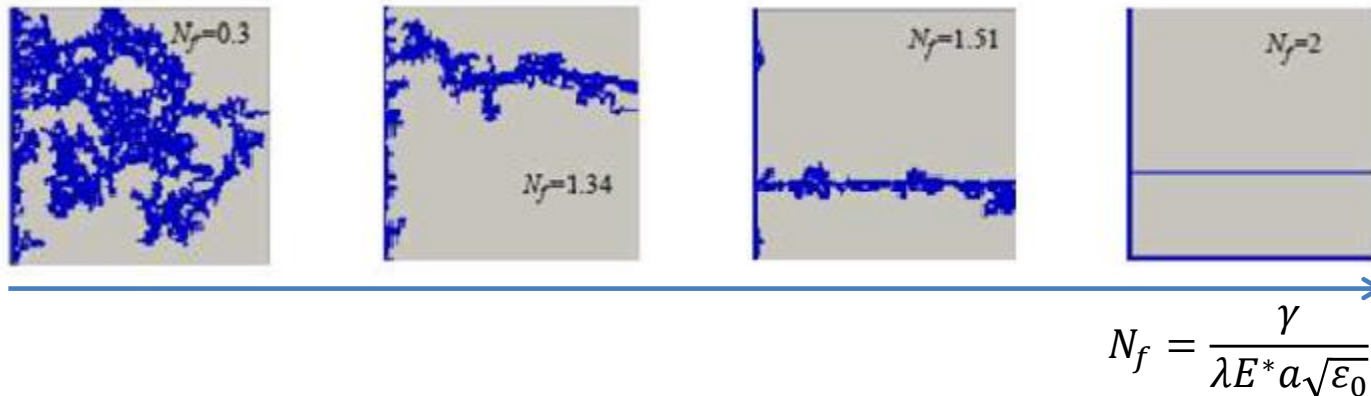
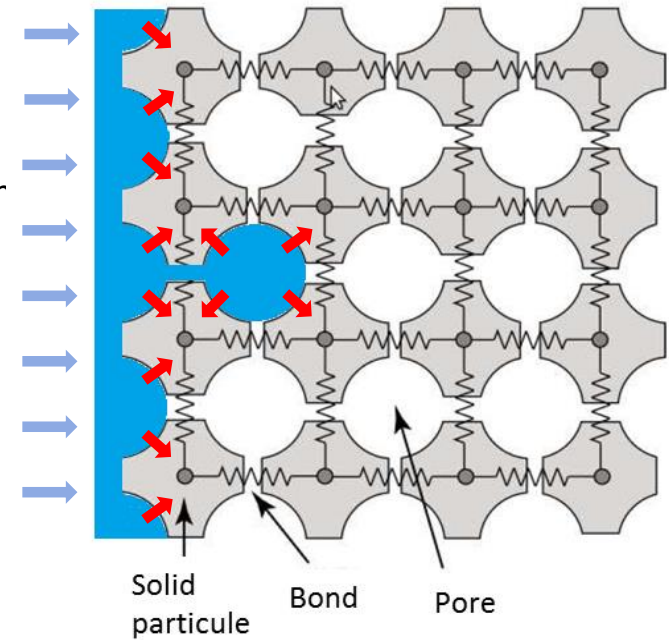

[1] Holtzman & Juanes, *Physical Review E*. (2010)

[2] P. Lefort, *PhD Thesis* (2014)

Perspective: deformable medium

- Evaporation of a droplet in a network of pillars

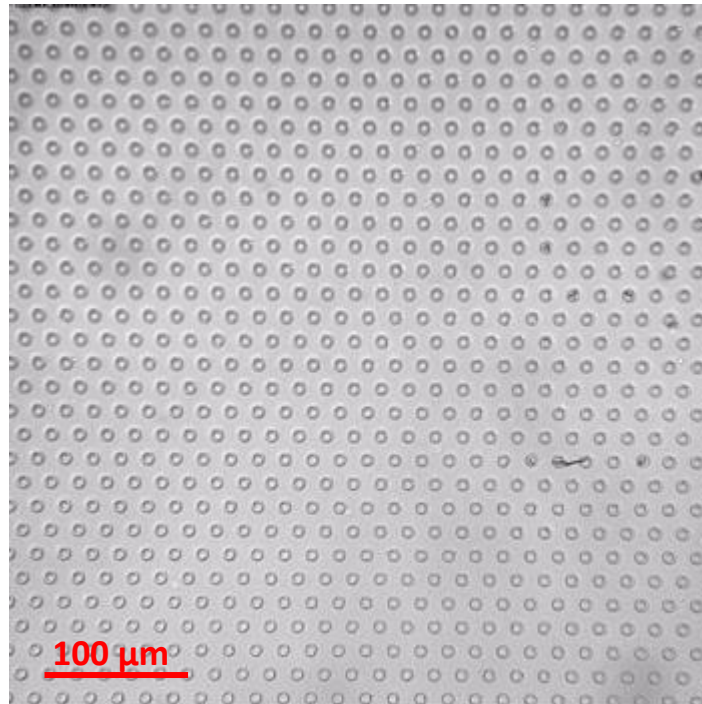
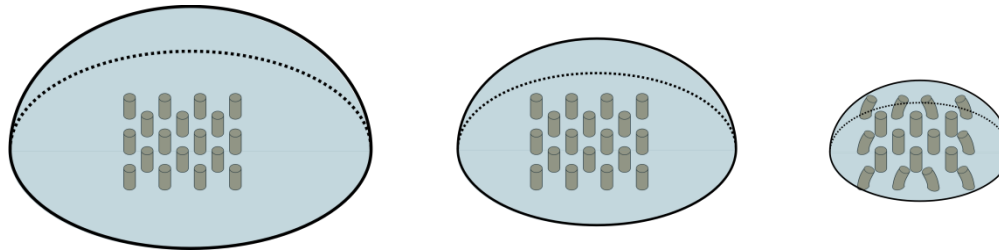

=> Bending and collapse of pillars by capillarity

Thank you for your attention