



**HAL**  
open science

## Aircraft passenger door optimized by electrifying its energy system

Grégoire Le Goff, Sébastien Devillez, Jean-François Llibre, Carole Hénaux

► **To cite this version:**

Grégoire Le Goff, Sébastien Devillez, Jean-François Llibre, Carole Hénaux. Aircraft passenger door optimized by electrifying its energy system. More Electric Aircraft 2024, ISAE Supaero, Feb 2024, TOULOUSE, France. hal-04452054

**HAL Id: hal-04452054**

**<https://hal.science/hal-04452054>**

Submitted on 12 Feb 2024

**HAL** is a multi-disciplinary open access archive for the deposit and dissemination of scientific research documents, whether they are published or not. The documents may come from teaching and research institutions in France or abroad, or from public or private research centers.

L'archive ouverte pluridisciplinaire **HAL**, est destinée au dépôt et à la diffusion de documents scientifiques de niveau recherche, publiés ou non, émanant des établissements d'enseignement et de recherche français ou étrangers, des laboratoires publics ou privés.

# Aircraft passenger door optimized by electrifying its energy system

Grégoire Le Goff (1), Sébastien Devillez (2), Jean-François Ilibre (3), Carole Henaux (4)

1 : LAAS, Université de Toulouse, CNRS, 7 Avenue du Colonel Roche, Toulouse, France, glegoff@laas.fr

2 : LATECOERE, 135 rue de Périole 31079 Toulouse, France, sebastien.devillez@latecoere.aero

3 : LAPLACE, Université de Toulouse, CNRS, INPT, UPS, 2 rue Charles Camichel, Toulouse, France, jean-francois.ilibre@laplace.univ-tlse.fr

4 : IES Institut d'Électronique, Université de Montpellier, Montpellier, France, carole.henaux@umontpellier.fr

## Abstract

*The electrification of aircraft passenger doors is technically feasible. It is already performed in large cargo doors because the size of the door prevents the direct use of a mechanism driven by human force. Passenger door size remains small enough to be compatible with human capacity except for emergency openings where assistance needs to be provided to guarantee the opening in some crash configurations (broken landing gear, wind). Since an attendant must be present for safety reasons, electrifying passenger doors does not bring direct value to the product. The feasibility of electrifying a passenger door has been demonstrated successfully through the NexGED research program, but it highlights the difficulty of achieving the main need of the market, which is the cost. Effectively saving on the mechanism is small, but implementing motors generates new costs. Using a functional approach and value analysis, new architectures with electric functions that are cost-effective are defined. Replacement of the hydro-pneumatic assistance is one of them. Dedicated research efforts have been carried out to optimize the electrical actuator for this function.*

## Introduction

New aircraft incorporate more and more electrical systems. This trend has been illustrated in recent aircraft, such as the Boeing 787 or the A350. The first part of those electrical systems appears due to a shift from classical technologies like hydraulic, pneumatic, and human force transformed by mechanisms to electrical ones, while the other part comes from the addition of new functionalities, such as cabin internet. Electrical technology constantly improves its performance, enabling the replacement of other technologies. Aircraft doors do not escape that tendency, as, for example, the motorization of A380 doors and a research program like NexGED. This electrification shift can be compared to what occurred in the automotive industry, but with a main difference: the aircraft is a means to earn money for airline companies, and each change needs to bring an economic improvement to the aircraft.

Supported by the DGAC, the first part of the project analyzes the candidate functions for door actuation electrification using a functional approach and value analysis. The second part of the project, which involves a research laboratory and a manufacturer, aims to redefine the kinematics of the opening and closing of aircraft doors. This redefinition associated with the maneuverability of electrical systems also makes it possible to review the ergonomics of the functions required by the application. Facilitating normal opening and closing handling by the crew while guaranteeing an emergency opening are the key points of the study.

From the point of view of the kinematic chain and, more specifically, of the electric motor, the goals that combine daily use with very diversified environmental constraints (external temperature, wind exerting forces) and yet, with emergency opening under crash

conditions (landing gear broken), lead to a genuine challenging design of a high-performance motor and its suitable speed and position control (acceleration and deceleration slopes and limited opening angle required). The whole drive (gearbox-motor-control and power supply) must therefore guarantee good efficiency, good dynamics, and precision over very different operating cycles (daily or emergency). One of the main challenges is satisfying the conflicting requirements, such as providing a rated torque at low speed in daily use and yet a very high torque and high speed in emergency use.

In order to tackle these challenges, and compared with aircraft architectures that have already electrified door-related functions, the work carried out here proposes a more holistic approach. Indeed, the functional analysis approach adopted aims to achieve better system integration through electrification. This leads to greater homogeneity in the door system.

The paper presents the results of a comprehensive design approach ranging from architectural analysis, through analytical pre-sizing, optimization-based design, optimization-based control architecture design, embedded real-time control algorithm development, and the production of a working prototype to experimental proof of high performance.

Thanks to the work carried out, it is now possible for the door system to provide new capabilities in a resilient way when facing different, heterogeneous operating modes, and to readily adapt to them in a fully controlled manner.

First, section 1 gives the challenges of the door system design. Section 2 presents the architecture of the door actuation system through a functional and a value analysis. The objectives of the door system design are given. Then, sections 3 and 4 detail the design of the electric motor and the control strategy.

## 1. Challenges of the door system design

On commercial airplanes, forward and aft left-hand doors are used for boarding and deplaning of passengers, while forward and aft right-hand doors serve for catering. Generally, these doors are also used as emergency exits. That is why they are defined by two contradictory requirements:

1. Guarantee that the door will not open in flight;
2. Guarantee that the door will open in an emergency.

The closing sequence could be divided into three main phases:

1. Door rotation from the fully open position to fuselage proximity;
2. Engagement of the restraint mechanism (called latch, with its security called lock);
3. Activation of the emergency system (opening assistance means, evacuation slide).

In the case of a normal opening, it is just the same steps in the opposite order. However, before the opening, the attendant will check that the external environment is appropriate.

If we look now an emergency opening from the inside, the sequence will be the following:

1. Verify no external threats;
2. Disengagement of the restraint mechanism;
3. Release of the energy for the opening assistance means;
4. Start of rotation;
5. Release energy and start of slide inflation;
6. Rotation simultaneously to slide inflation.

If the door is opened in an emergency from outside, before step 2, the emergency system will be deactivated, the assisting opening means will not operate and the slide will not deploy in order to protect the firemen.

Of course, those sequences and the associated components need to comply with airworthiness regulations FAR[1]/CS[2] 25.783 (Doors) and 25.807 to 25.813 (Emergency exits).

During the door research project, the interests and benefits due to the electrification of the above sequence are analyzed. One of the critical components was the emergency power supply and its activation. Indeed, the safety requirement could not be met by considering only the aircraft power bus. Energy storage for the evacuation system must be provided at each door. One may also wonder how and when to deliver the stored energy. If the power supply loss detection is used to decide when to deliver the energy, it will be required to take into account the extended-range twin-engine operations performance standards (ETOPS) for storage sizing, because currently after an engine shutdown, the electrical power supply is limited to essential components.

On the other hand, if chosen to activate the emergency power supply just before its use, there is a need to find a reliable signal. One of them is the manipulation of the main door handle, but it means that what occurs before

will not have this energy. This generates a constraint for the external threat detection system.

Once the system's architecture is defined, the design of the electrical actuator is optimized to replace the current hydro-pneumatic solution. To achieve it, emergency system specificities must be taken into account, such as the need for high power during a short time (the allowed time in the most critical operating mode is 4 s and that will occur less than twice in the aircraft's life).

## 2. Architecture

The design process of the architecture was driven by a functional approach and value consideration.

First, the functional approach allows us to rationalize the energy consumption in regard to its use and thus identify the benefits of a single electrical source and its associated actuation system.

On the other hand, the value analysis enables the identification of the benefits of electrification. For example, if one switches the hydro-pneumatic solution for the electrical one, it is essential to show that the combination of manufacturing cost, weight, operating and maintenance cost provides an advantage to the aircraft.

### 2.1. Functional approach

The functional approach starts by establishing a functional architecture as shown in Fig. 1. This functional architecture came from a function identification with a standard analysis NF EN16271 completed with an exhaustive list of usage scenarios. It is then possible to generate the technical functions associated with those needs and organize them in an architecture linking those functions by the various information and energy flows involved.

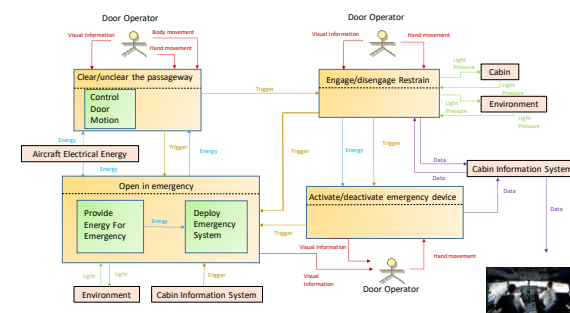

Fig. 1: Functional architecture

Four main functional blocks, highlighted in orange in Fig. 1, are identified in Table 1.

Function	Energy source
Engage/disengage Restrain	Human
Clear/unclear the passageway	Human/Mechanic
Activate/deactivate emergency device	Human
Open in Emergency	Pneumatic/Light/Electrical

Table 1: Main blocks of the functional architecture

It clearly appears that an external energy supply is needed for emergency opening:

- Door assistance means: pneumatic;
- Slide deployment: pneumatic;
- External detection: light/electrical.

Actually, the door-assisting means and the slide use two different storage devices and associated regulating components. Sharing the pneumatic storage raises technical and maintenance issues. However, electrification is an efficient way of achieving emergency energy sharing. It brings direct benefits by removing duplication of functions. This potential needs to be confirmed by the value approach.

To detect external threats, light associated with an optical device is used. The light is currently shared with A/C emergency lighting and depends on specific requirements. There is no direct benefit from connecting the light to the door system. Interest in replacing the window by an electrical device is tied to the value brought by the technology.

Additionally, normal opening requires a power flow mitigation function to control the speed of the door. Until now, a hydraulic control of the door speed in normal and emergency operation was implemented. These functions can easily be covered with an electrical actuator for daily use and emergency operations.

## 2.2. Value approach

Replacing human energy by electrical energy provides value only if it reduces the cost of the energy or leads to mechanism simplification. As attendants are mandatory, the human energy is already available and the value needs to be demonstrated through the simplification of the mechanism.

Restrain function could not be made directly by electrical components. Furthermore, if only one motor is considered, most of the mechanical elements remain the same. This explains why no value has been identified for this function.

On the other hand, the mechanism to activate the emergency system, and particularly the slide, contains many mechanical links between the handle and the final action that can be removed using an electrical motor with a switch at the handle. This results in weight and cost savings, especially if an emergency power supply already exists on the door.

Emergency assistance means and slide both use the same kind of energy (pneumatic). The outcome from the analysis is that all together, a common electrical energy source for the electrical actuator and the electrical pump globally provides value compared to the current solution. Additionally, the electrical solution allows, in an emergency, improved slide deployment thanks to a higher performance speed control and, in the daily opening, reduces the risk of attendants falling down the aircraft while manipulating the service door. Replacement of the window by an electrical device

needs an additional means to allow information transmission from inside to outside (pressure indicator, communication between attendant and ground operator...). It does not provide direct cost or weight advantage and reduces reliability (in the way that even a scratched window is still operating). It also complicates the activation of the emergency power supply, as the visual means need to be available before the mechanism's motion starts. Nevertheless, it allows the attendant to observe outside of the aircraft while seated because the location is less constrained. Concerning safety and reliability capabilities, emergency pieces of equipment are also good candidates for electrification. First, as there are several doors to ensure proper aircraft exit function, safety is less critical and it is acceptable to have one of them not working. Secondly, the system that is replaced when electrification takes place is already complex and has a reliability comparable to that of the electrical system. Of course, if the mechanism actuated by human force is replaced by an electrical one, reliability is degraded. However, it should be mentioned that with this new electrified architecture, compliance with the airworthiness regulations is ensured.

## 2.3. Proposed Architecture

The final electrical architecture contains the following functions and devices:

- Connection to 28 VDC for normal operation;
- Electrical emergency energy supply triggered by the main handle with door in emergency operating mode;
- Door actuator (function 2) for daily use and emergency;
- Slide electrical inflation pump;
- Girt bar actuator for daily use and emergency;
- Optional virtual window;
- Control box.

Different trade-offs between aircraft power buses (28 VDC, 115 VAC, 270 VDC) show that the most efficient solution is obtained for the 28 VDC.

For energy storage, supercapacitors, lithium-ion batteries, and thermal batteries were analyzed. The capacity to provide the required amount of energy in a short time without side effects leads to the selection of a thermal battery.

The feasibility of inflating the slide was demonstrated by pre-sizing a pump and its electrical motor.

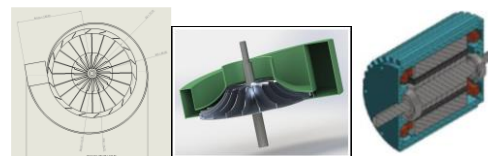

Fig. 2: Electrical inflation pump of the slide

The door actuator is detailed in the second part.

The girt bar actuator has also been pre-sized. The linear concept has been selected thanks to the optimized design of the mechanical link, which avoids using a mechanical gearbox.

The electrical window has been set as optional. For emergencies, a classical window is installed. For normal operation, a display fitted on the fuselage allows the attendant to control what happens outside the aircraft.

The control box has been designed to use discrete logic in order to obtain a control system easy to certify. The design of the system associated with this architecture requires the use of the same systems engineering methods as those usually applied to any aircraft complex component.

However, to maximize the value of electrification, the design should not be based on the same specifications as those usually used for hydro-pneumatic systems, but the specification itself needs to be reconsidered in order to take full advantage of the benefits of electrification. This architecture could be reduced to some functions, at least to the door rotation. In this case, the energy storage, the control box, and the electrical actuator need to be competitive with regard to the hydro-pneumatic solution. This is why optimizations, detailed in the following sections, are implemented in order to design it.

### 3. Optimal sizing of the door electrical actuator

#### 3.1. Wise choice of the gear ratio

The type of motor chosen for the application is the Radial Permanent Magnet Synchronous Motor (RPMSM). It offers the highest power density with the best efficiency. The sizing of the motor is done using an analytical model [3] and based on the armed emergency (noted UA) operating mode, which is the most demanding one. The volume allocated to the motor and gearbox is very limited. The chosen reduction solution consists of a ball screw, combined with a 1- to 3-stage reduction system allowing reversibility. The characteristics of the gearbox must enable backdriving since the door has to be opened and closed. For simplicity and integration in the allocated volume, the motor shaft is parallel to the ball screw. Fig. 3 shows the impact of the gear ratio on the motor mass and, therefore, its volume. For low gear ratios, the motor will be rather bulky, as it will have to deliver high torque at a low speed. Conversely, for high gear ratios, the electric motor will be small, as it will need to deliver low torque at high speed. The smaller the gear ratio, the more expensive the gearbox, and the more difficult it will be to ensure the reversibility of the powertrain. Also, the reduction in size of the motor makes it more complex to manufacture.

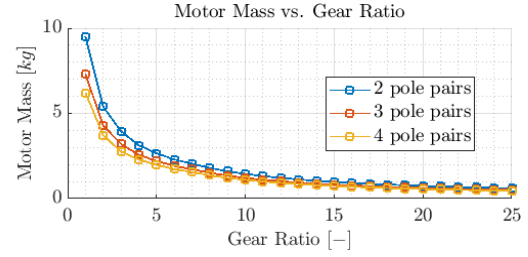

Fig. 3: Motor mass vs gear ratio

The number of pole pairs  $p$  of the motor is a key parameter. As  $p$  increases, the back iron yokes can be reduced, implying a reduction in volume. However, for the same speed requirement, the iron losses are higher and the efficiency may be lower.

For gear ratios above 15, the gain in weight is no longer significant and the backdriving is no more feasible, thus the chosen gear ratio leads to a motor mass of around 1 kg and an acceptable volume. Therefore, the gearbox will be roughly the same weight. Once the reduction ratio is set, the average torque and speed of the motor are deduced from the UA operating mode.

#### 3.2. Parametric optimal sizing of the electric motor

In the UA operating mode, the operating time is 4 s. As this time is relatively short, it is possible to size the motor for a lower torque than the maximum torque required and, for a short time, inject an overcurrent with very little thermal risk. Thus, let the motor sizing torque  $T_{em}^n$  be an adequate fraction  $1/k$  of the maximum required torque in UA mode  $T_{em}^{UA}$ , thus:  $T_{em}^n = T_{em}^{UA}/k < T_{em}^{UA}$ . For  $T_{em}^n$ , the chosen current density  $J$  in the conductors is set to 5 A/mm<sup>2</sup>, compatible with natural convection cooling [4]. For the short duration of the UA operating mode, the motor is thermally and magnetically capable of supplying  $T_{em}^{UA}$ .

The number of conductors  $n_c$  in each slot of the motor is chosen according to the average speed, about 2500 rpm in UA, and the voltage  $V_{DC}^{UA}$  available in this mode, as well as the DC bus network voltage  $V_{DC}^{bus}$  for other operating modes.

Knowing the torque, the speed, the allocated space, the supply voltages, and the allowed current density, three kinds of RPMSM have been designed. A parametric optimization as in [5] is carried out to determine the geometric parameters  $x_i$  (length, diameter, magnet sizes, yoke sizes, airgap thickness) of each RPMSM. Equation (1) presents the optimal design problem (ODP) where the cost function  $f_{obj}$  to minimize is the active mass  $M_{act}$  under the following constraints (*u. c.*): the average torque  $T_{avg}$  of the motor has to reach at least the adequate fraction of  $T_{em}^{UA}$ . In addition to [5], a constraint on the maximum cogging torque  $T_{cog}$  of the motor is included. It must be lower than the maximum authorized cogging torque for the application.

$$ODP: \begin{cases} \min f_{obj}(x_i) = M_{act} \\ u. c. T_{avg} \geq T_{em}^{UA}/k \\ T_{cog} \leq T_{cogmax} \end{cases} \quad (1)$$

Fig. 4 shows the distributed winding (DW), concentrated winding (CW), and fractional winding (FRW) motors resulting from solving the optimization problem (1) when applied to the three different analytical models associated with those machines. Table 2 gives some characteristics of the motors.

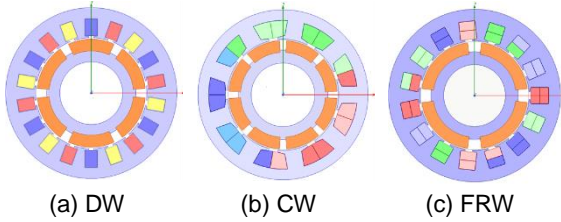

Fig. 4: DW, CW, and FRW motors

	$p$	$n_e$	Vol (cm <sup>3</sup> )	Mass (g)
DW	3	18	242	858
CW	4	9	219	802
FRW	2	15	297	973

Table 2: DW, CW, and FRW characteristics

The torque ripple in the motor is due to the interaction between the harmonic content in the magnetic field generated by the moving part and the magnetomotive force provided by the static part. CW and FRW motors have low torque ripple, which is not the case for the DW motor. To reduce the torque ripple of the DW motor, the stator is skewed by one slot pitch.

Fig. 5 gives, for the three motors, the per-unit torque  $T_{em}/T_{em}^n$  (%) for a 90° motor position span. Note that the FRW motor presents a higher torque than the two other motors. The cogging torque ripple is inversely proportional to the least common multiple between the number of poles ( $2p$ ) and the number of slots ( $n_e$ ). Therefore, the cogging torque of the DW motor should be the highest. Fig. 5 deduced from finite element analysis (FEA) calculations carried out in 2D, confirms this expectation. The one-slot pitch skewing has not been taken into account in those calculations. However, with the manufactured prototype, the DW motor's cogging torque is at the same level as that of the CW motor.

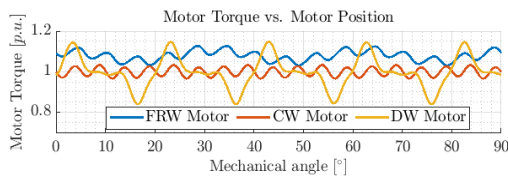

Fig. 5: Per unit torque vs mechanical angle

### 3.3. Electric motor choice

To choose between the three motors, it is necessary to add feasibility criteria. The three stators were first 3D printed in PA2200 HD (Polyamide powder sintering, SLS technique). Once printed, the stators were wound by a winding company. This makes it possible to obtain the real lengths of the coil ends and the mass of the winding. Fig. 6 shows the wound stators.



Fig. 6: DW, CW, and FRW motors

Table 3 displays a comparison between the three motors based on winding manufacturing, bulk, and electromagnetic performances. The chosen color code is as follows: green for favorable criteria, red for unfavorable criteria, and orange for average criteria.

	DW	CW	FRW
Winding easiness	Green	Green	Red
Coil heads	Orange	Green	Red
Inductance	Orange	Orange	Green
Electromotive force THD	Orange	Green	Green
Electric frequency	Orange	Red	Green
Torque ripple	Orange	Green	Green
Mass	Green	Green	Red

Table 3: DW, CW, and FRW comparison

The FRW motor has the biggest coil end winding volume and therefore a greater overall length and mass. It is also the most complex winding to achieve. The CW motor is the most interesting in terms of weight and volume (see Table 2). Its end-winding lengths are the shortest. The DW motor is the simplest to make. DW and CW motors have low inductances which can be a liability for the power supply due to higher current ripples. A higher electrical frequency in the coils means greater iron losses in the ferromagnetic yokes. The excellent performance of the CW motor should therefore be put into perspective. It is the best choice if only considering the motor, yet not the wisest from a system point of view.

To address the system optimum seeking concerns, motors must be evaluated together with their control, thus, two prototypes have been built: the DW and the CW (see Fig. 7 and 8).



Fig. 7: DW and CW prototypes without winding and magnet

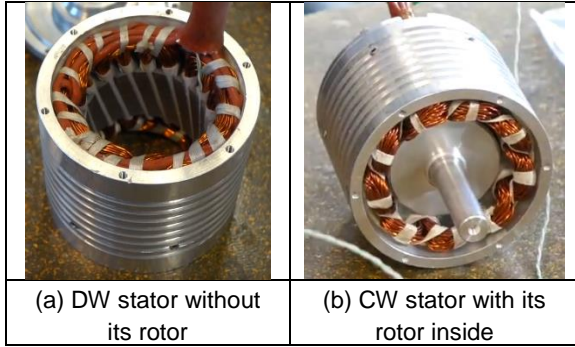

Fig. 8: DW and CW prototypes

#### 4. Control of the electrical actuator

To guarantee that the mission scenario for which the sizing has been carried out is actually achieved, the system is provided with its dedicated control architecture. The specifications include a significant number of requirements in terms of speeds and accelerations that must not be exceeded for the four different scenarios considered, the UA is one of them. So, with the aim of guaranteeing door opening within a given time, several mission profiles are possible. An offline Pontryagin Maximum Principle (PMP) control optimization method [6] is then implemented to determine the best mission profile (acceleration, speed, and position) for each scenario. The optimization problem addressed is formulated as follows, by (2).

$$\text{OCP: } \left\{ \begin{array}{l} \min_{\theta} J = \int_0^T \dot{\theta}^2 dt \\ \text{subject to:} \\ \theta = \int \dot{\theta} dt \quad \dot{\theta} = \int \ddot{\theta} dt \quad (2) \\ \theta(0) = \theta_0 \quad \theta(T) = \theta_T \\ \dot{\theta} \in \text{Maximum Speed Envelope} \\ \ddot{\theta} \in \text{Maximum Acceleration Envelope} \end{array} \right.$$

The optimal control problem (OCP) is solved using the semi-direct collocation algorithm [7]. Fig. 9 shows the results obtained for the UA scenario.

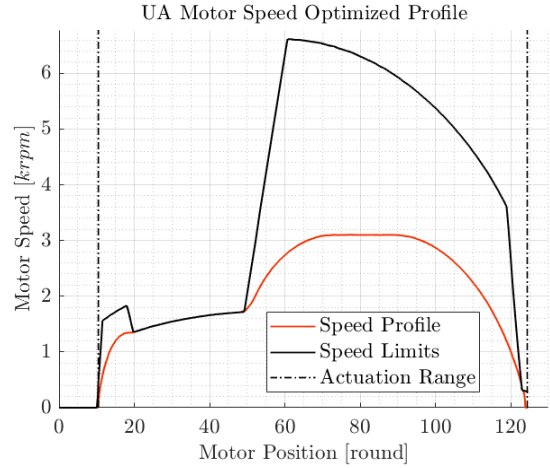

Fig. 9: Optimal solution of (2) for the UA scenario.

The mission profiles thus determined are setpoint profiles that the actuator must track when the door is triggered to open. As the solution of (2) holds the optimized acceleration, speed, and position profiles, various corresponding actuator control architectures can be explored, as shown in Fig. 10.

This variety of architectures includes several blocks. Some of which are common to them all; from right to left in Fig. 10:

- a pulse-width modulator (PWM) that generates the gate firing signals for all the inverter's switching cells. Its purpose is to ensure that the stator voltage references are met. Here, the PWM technique is a regular symmetric PWM (RSPWM) with aligned carriers [8];

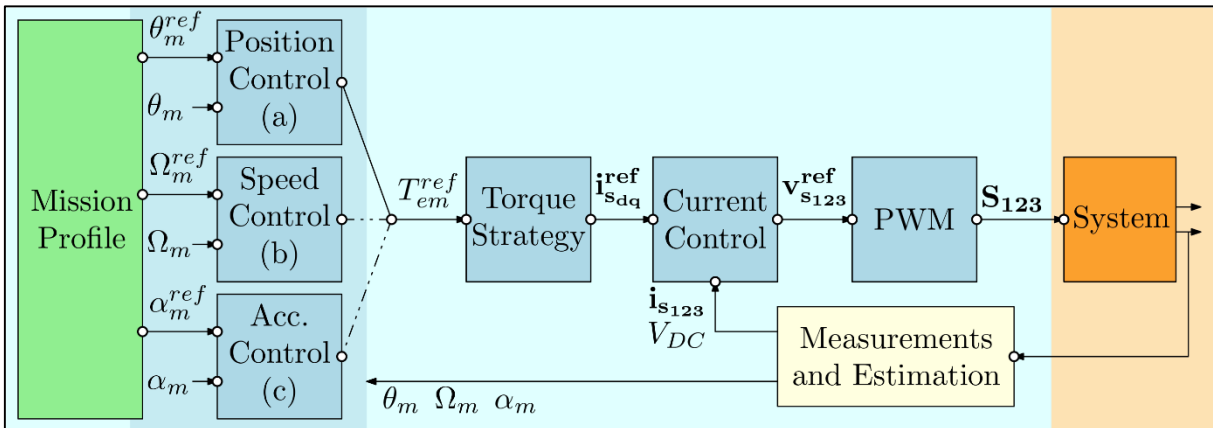

Fig. 10: Control architectures for the door actuator. (a) Position control, (b) Speed control, (c) Acceleration control

- a current proportional-integral (PI) controller that computes the stator voltage references. To improve closed-loop dynamic performance, control is performed in the Park reference frame with a non-linearity compensator [9]. The PI is accompanied by an anti-wind-up technique;

- a maximum torque per ampere (MTPA) strategy is then deployed to provide the maximum torque at minimum current consumption and thus minimum conduction losses [10]. It computes the lowest current magnitude references that guarantee a specified torque setpoint.

Note that "System" in Fig. 10 stands for the electromechanical actuator made of its battery, three-phase converter, and electrical motor.

The remaining block, dedicated to higher-level control of the mechanical behavior, varies according to the chosen architecture, which can either be a motor position controller (a), a motor speed controller (b), or a motor acceleration controller (c). For all three approaches, mainly state feedback and PI controllers are developed. They are tuned according to a pole placement requirement. This variety of architectures was tested in simulation using Matlab and Simulink to first evaluate the complete control architectures against the requirements before implementing them on a hardware prototype.

Fig. 11 shows motor speed and position reference tracking for the motor speed control architecture (see option (b) in Fig. 10). It can be concluded that the mission profile is tracked with very good dynamic performances, such as low tracking error while taking into account speed limitations. The control architecture was then progressively compiled for real-time in a step-by-step process to validate its various blocks.

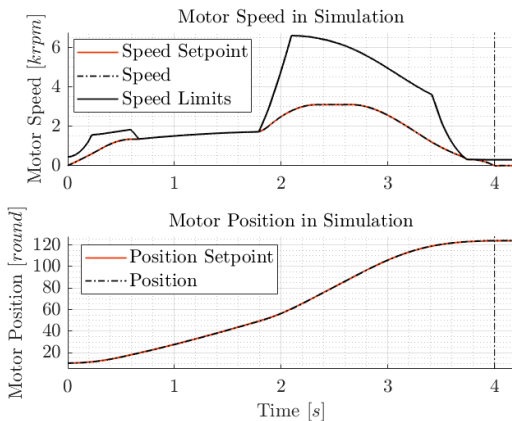

Fig. 11: UA speed reference tracking in simulation.

Considering the higher-level controller that governs the motor speed (option (b)), Fig. 12 shows the effectiveness of speed reference tracking, for the DW motor prototype, using a step response test. Reference tracking is ensured in less than 100 ms as designed.

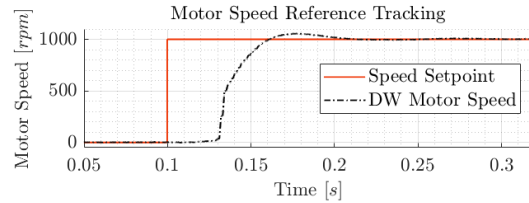

Fig. 12: Speed reference tracking - DW prototype.

Based on the ability to control the motor speed, the actual torque-speed map of the prototypes can be identified and compared to the requirements, in order to assess how close the actuators and their control are to the objectives. Thanks to a configurable mechanical brake, an experimental bench was set up to measure the torque-speed map of the two prototypes. Fig. 13 shows the comparison between the required map and the experimental maps under a  $V_{DC}^{UA}$  bus supply for the inverter.

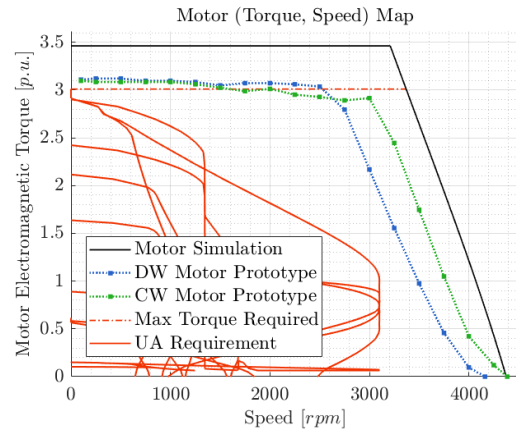

Fig. 13: (Torque, Speed) map of both prototypes.

Both prototypes perform very well with respect to their goals. Indeed, although they perform less than the theoretical simulation (about a 10% drop on maximum torque), their envelopes in the torque-speed map comfortably cover the requirements for the UA operating mode.

## Conclusions

Analysis of door function, considering the energy involved associated with a value approach, makes it possible to identify how electrification brings outstanding benefits. This approach allows us to propose a new promising architecture.

The optimized development of one of the main functions shows the advantages offered by the electrical motor and the performance of the solution. Indeed, thanks to the optimization of the control architecture performed, a non-trivial trajectory was found that met all constraints and objectives while minimizing energy consumption.

The development of the actuator control architecture has not only shown that the system, sized for normal operation also via optimization, does indeed feature the characteristics required to track the optimal trajectory but also that it is capable of achieving the



required performance in emergency operation without having to be resized for that very purpose.

### References

- 1 United States Federal Aviation Administration – Regulation FAR 25
- 2 European Aviation Safety Agency – Certification Specification CS-25
- 3 Yvan Lefèvre, Sami El-Aabid, Jean-François Llibre, Carole Hénaux, Sarah Touhami. "Performance assessment tool based on loadability concepts," *International Journal of Applied Electromagnetics and Mechanics*, 2019, 59 (2), pp.687-694.
- 4 J. Pyrhönen, T. Jokinen, V. Hrabovcova, "Design of rotating electrical machines," 2nd Edition, John Wiley & Sons, 2014
- 5 Jean-Francois Allias, Jean-François Llibre, Carole Hénaux, Yves Brière, Soheib Fergani. "Comparison, with an analytical optimization process, of two synchronous Halbach permanent magnet machines, for a direct drive stick application. *Progress In Electromagnetics Research B*, 2016, 69, pp.47-59.
- 6 V. G. Boltyanski, R. V. Gamkrelidze, E. F. Mishchenko, and L. S. Pontryagin, "The maximum principle in the theory of optimal processes of control," *IFAC Proceedings Volumes*, vol. 1, no. 1, pp. 464–469, Aug. 1960. doi: 10.1016/S1474-6670(17)70089-4
- 7 J.-B. Caillau, R. Ferretti, E. Trélat, and H. Zidani, "Chapter 15 - An algorithmic guide for finite-dimensional optimal control problems," in *Handbook of Numerical Analysis*, E. Trélat and E. Zuazua, Eds., in *Numerical Control: Part B*, vol. 24. Elsevier, 2023, pp. 559–626. doi: 10.1016/bs.hna.2022.11.006.
- 8 S. R. Bowes, "New sinusoidal pulsewidth-modulated inverter," *Proceedings of the Institution of Electrical Engineers*, vol. 122, no. 11, pp. 1279–1285, Nov. 1975, doi: 10.1049/piee.1975.0312.
- 9 R. B. Sepe and J. H. Lang, "Inverter nonlinearities and discrete-time vector current control," *IEEE Transactions on Industry Applications*, vol. 30, no. 1, pp. 62–70, Jan. 1994, doi: 10.1109/28.273622.
- 10 S. Morimoto, K. Hatanaka, Y. Tong, Y. Takeda, and T. Hirasu, "High performance servo drive system of salient pole permanent magnet synchronous motor," in *Conference Record of the 1991 IEEE Industry Applications Society Annual Meeting*, Sep. 1991, pp. 463–468 vol.1. doi: 10.1109/IAS.1991.178196.