



HAL
open science

Curing-dependent thermo-viscoelastic and shrinkage behaviour of photopolymers

Kubra Sekmen, Thomas Rehbein, Michael Johlitz, Alexander Lion, Andrei Constantinescu

► **To cite this version:**

Kubra Sekmen, Thomas Rehbein, Michael Johlitz, Alexander Lion, Andrei Constantinescu. Curing-dependent thermo-viscoelastic and shrinkage behaviour of photopolymers. *Mechanics of Materials*, 2023, 179, pp.104566. 10.1016/j.mechmat.2023.104566 . hal-04451837

HAL Id: hal-04451837

<https://hal.science/hal-04451837v1>

Submitted on 12 Feb 2024

HAL is a multi-disciplinary open access archive for the deposit and dissemination of scientific research documents, whether they are published or not. The documents may come from teaching and research institutions in France or abroad, or from public or private research centers.

L'archive ouverte pluridisciplinaire **HAL**, est destinée au dépôt et à la diffusion de documents scientifiques de niveau recherche, publiés ou non, émanant des établissements d'enseignement et de recherche français ou étrangers, des laboratoires publics ou privés.

Curing-dependent thermo-viscoelastic and shrinkage behaviour of photopolymers

Kubra Sekmen^a, Thomas Rehbein^b, Michael Johlitz^b, Alexander Lion^b,
Andrei Constantinescu^{a,*}

^a*Laboratoire de Mécanique des Solides, CNRS, École Polytechnique, Institut Polytechnique de Paris, Route de Saclay, Palaiseau, 91128, France*

^b*Department of Aerospace Engineering, Institute of Mechanics, Bundeswehr University Munich, Werner-Heisenberg-Weg 39, Neubiberg, 85577, Germany*

Abstract

This study investigates the influence of curing on the thermo-viscoelastic properties and chemical shrinkage of a commercially available photopolymer resin used in SLA and DLP 3D printing and presents a modelling approach for predicting material properties. UV rheometer and DMA measurements were performed to investigate the viscoelastic properties of the photopolymer material as a function of temperature, degree of cure, and frequency. Time-temperature and time-cure superposition principles were applied to the experimental results. In addition, the chemical shrinkage behaviour was studied by the UV rheometer as a function of the degree of cure and temperature, and a model equation was proposed based on these parameters. Our experimental findings have led to the development of constitutive equations for the complete material behaviour.

Keywords: Photopolymer, Curing, Viscoelastic constitutive law, Shrinkage strain

*Corresponding author.

Email addresses: kubra.sekmen@polytechnique.edu (Kubra Sekmen), rehbein@unibw.de (Thomas Rehbein), michael.johlitz@unibw.de (Michael Johlitz), alexander.lion@unibw.de (Alexander Lion), andrei.constantinescu@polytechnique.edu (Andrei Constantinescu)

1. Introduction

A tremendous advancement in additive manufacturing (AM) technologies over the past few decades has reshaped the way industrial products are created, enabling the production of parts with remarkable accuracy that is not achievable with conventional manufacturing techniques [1, 2]. The primary characteristic of additive manufacturing is the layer-by-layer fabrication of three-dimensional structures as opposed to the traditional production based on subtractive or formative material processing. This cutting-edge manufacturing method enables innovative designs that cannot be obtained with traditional manufacturing techniques, such as 3D printing of lightweight lattice structures known for their superior mechanical properties for a given density or weight [3].

Particularly, curing of a liquid monomer resin into a solid polymer through photopolymerization allows manufacturing of parts with a resolution of layer thickness varying from 10 to 200 μm that can be achieved today for affordable prices [4]. According to the methods of layer deposition, pattern formation principles, and operating systems, photocuring-based 3D printing uses a variety of techniques, such as stereolithography apparatus (SLA) [5], digital light processing (DLP) [6], polyjet printing (PJP) [7], two-photon lithography (TPL) [8], UV-assisted direct ink writing (DIW) [9], continuous liquid interface production (CLIP) [10] and liquid crystal display (LCD) [11]. Fast curing at room temperature, low energy consumption and spatial and temporal control over photopolymerization are all highly desirable in a wide range of industrial applications, including dental materials [12], consumer goods such as shoes and custom insoles [13], coatings [14], biomedical devices and tissue scaffolds [15], metamaterials [16], piezoelectric materials [17] and lithium-ion batteries for aerospace applications [18].

The growing demand for photopolymerization-based 3D printing necessitates special consideration in advanced applications requiring precise control of final material properties, as well as understanding and modelling of the mechanical properties related to the UV curing reaction. During the curing reaction, a viscoelastic liquid converts into a viscoelastic solid, resulting in changes in thermomechanical and caloric material behaviour [19]. The polymer chains become packed and crosslinked as a result of this phase change and the newly formed chemical bonds bring the chains closer together, resulting in a reduction in the specific volume known as volume or curing shrinkage. This chemical shrinkage, coupled with other phenomena such as resin composition,

38 nonuniform light intensity with depth due to the Beer-Lambert absorption
39 [20] and heterogeneous curing due to nonlinear light intensity, leads to gra-
40 dients in the mechanical and chemical material properties and ultimately to
41 residual stresses that affect the shape of the final structure in desirable or
42 undesirable ways [21]. The repeatability and reliability of these products
43 are restricted by the fabrication errors in the parts due to the layer-by-layer
44 printing as previously mentioned [22, 23].

45 Within the scope of the polymerization process, the effects of process pa-
46 rameters, resin composition, and filler particles on the thermal and rheologi-
47 cal properties were studied by experimental methods [19, 24, 25, 26, 27, 28].
48 However, it is both costly and time consuming to perform these tests and
49 find the appropriate experimental approach to predict the final properties of
50 the printed part using different process parameters. To avoid this classical
51 and expensive experimental procedure, simulation tools provide an excellent
52 alternative for the optimization of the process parameters to fabricate desired
53 parts. Nevertheless, due to a lack of understanding, insufficient constitutive
54 models and simulation tools, such problems are often confronted by costly
55 trial-and-error methods. Since the processed materials are viscoelastic for
56 such applications, constitutive models that take into account the time and
57 temperature history, in addition to the printing parameters, are required for
58 the numerical simulations to predict the material behaviour during and after
59 the printing process.

60 This work aims to overcome these difficulties by proposing a comprehen-
61 sive viscoelastic model with chemical shrinkage incorporating the highlighted
62 phenomena in temperature-dependent photopolymer curing. The PR48 pho-
63 topolymer resin under scrutiny in this work has been extensively studied in
64 previous research to investigate anisotropy in the mechanical properties in
65 printed parts [29, 30], resolution of the printed objects [29, 31], bonding of
66 the layers formed during printing [32], as well as to conduct photorheology
67 measurements and determine the cure depth [31, 33, 34]. However, to the
68 best of the authors' knowledge, systematic characterization and modelling of
69 this resin have not been reported in the literature. The model proposed in
70 this work is identified on thermal, viscoelastic and shrinkage experiments for
71 a large parameter range. As a consequence, it is able to predict the influence
72 of process parameters on the final mechanical properties.

73 This paper is organized as follows: Section 2 presents the commercial
74 photopolymer resin used for the material characterization, a reminder of the
75 curing model performed in the previous study, and the governing equations

76 of the linear viscoelasticity characterization. Section 3 focuses on the mea-
77 surements of the viscoelastic properties during the UV curing process and
78 viscoelastic material modelling based on time-cure superposition around the
79 gelation point. Section 4 is devoted to viscoelastic material modelling of dif-
80 ferent levels of crosslinked solid samples using DMA measurements. Herein,
81 the time-temperature and time-cure superposition principles were applied
82 to macroscopically capture the change in viscoelastic properties during the
83 complete crosslinking reaction. Section 5 provides measurements and mod-
84 elling of the evolution of the chemical shrinkage of a photopolymer layer as a
85 function of the degree of cure and the temperature, and Section 6 concludes
86 with some closing remarks and future prospects.

87 **2. Methods and theoretical foundations**

88 *2.1. Material*

89 The photopolymer resin used in this work is the standard clear thermoset
90 resin PR48 supplied from Colorado Photopolymer Solutions (Boulder, CO,
91 US). PR48 is designed to work with 385-405 nm light in digital light pro-
92 cessing (DLP) and stereolithography apparatus (SLA) 3D printers [35]. The
93 chemical structures of the ingredients of the PR48 resin is given in Figure 1
94 [36].

95 *2.2. Modelling of the crosslinking reaction*

96 The degree of cure $q(t)$ is a scalar measure of the advancement of the
97 crosslinking process driven by chemical reactions and physical processes. It
98 is defined in terms of specific heat flow as:

$$q(t) = \frac{\int_0^t \dot{h}(\tilde{t}) d\tilde{t}}{h_{tot}} \quad (1)$$

99 where $\dot{h}(\tilde{t})$ is the specific heat flow converted during the curing time t and
100 h_{tot} is the total heat of reaction of fully crosslinked material. We have previ-
101 ously investigated the crosslinking reaction in the photopolymerization pro-
102 cess using this relationship and modelled the reaction kinetics [37, 38, 23,
103 39]. Photo-differential scanning calorimeter (photo-DSC) measurements were
104 conducted to characterize the curing kinetics of the photopolymer resin under
105 several isothermal conditions and constant UV light intensities. The model
106 is briefly described in the following.

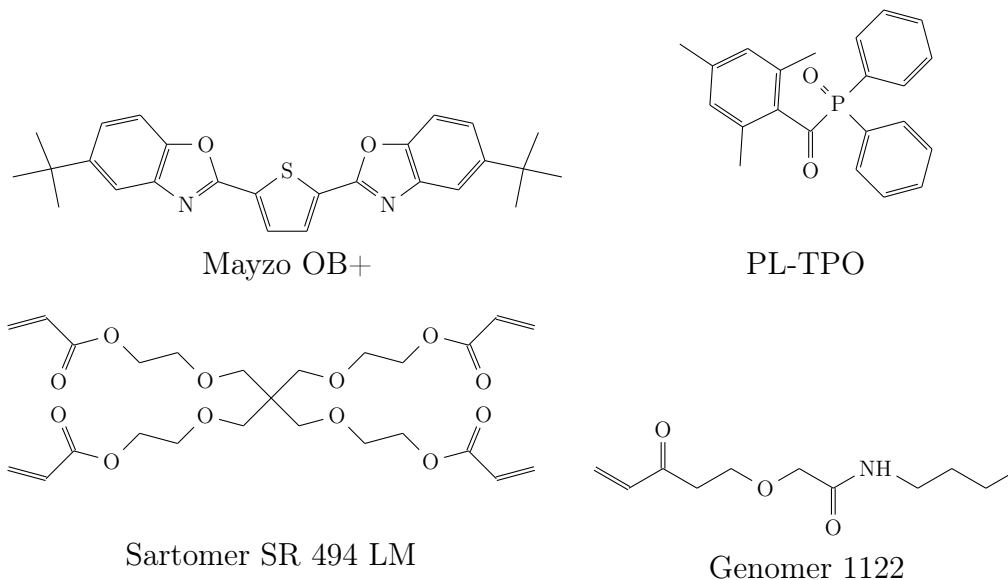

Figure 1: Chemical structures of the ingredients of the PR48 photopolymer material.

107 A phenomenological equation of $(m+n)^{th}$ order based on the autocatalytic
 108 kinetic model was used in order to model the evolution of the degree of cure.

$$\dot{q} = (k_1 + k_2 q^m) (q_{\max}(\mathcal{I}, \theta) - q)^n \quad (2)$$

109 In this ordinary differential equation (ODE), q_{\max} indicates the maximum
 110 attainable degree of cure as a function of temperature θ in $^{\circ}\text{C}$ and UV light
 111 intensity \mathcal{I} in mW/cm^2 , k_1 and k_2 are Arrhenius type coefficients that depend
 112 on the absolute temperature T in Kelvin and the light intensity as given in
 113 Equation 3:

$$k_i(\mathcal{I}, T) = A_i \exp\left(-\frac{E_i}{RT}\right) \left(\frac{\mathcal{I}}{\mathcal{I}_{ref}}\right)^b \quad i = 1, 2 \quad (3)$$

114 where E_i denotes the activation energies, $R = 8.314 \text{ J}/(\text{mol}\cdot\text{K})$ is the uni-
 115 versal gas constant, $\mathcal{I}_{ref} = 1 \text{ mW}/\text{cm}^2$ is a reference value to assure the unit
 116 consistency of pre-exponential factors A_i , and b is used to fit the experimen-
 117 tal data more precisely. Readers are referred to the preceding article [37] for
 118 further details on the working principle of the DSC, the experimental proce-
 119 dure, and the parameter identification. Details of the identified parameters
 120 can be found Appendix A.

121 The parameters given in Tables A.8 and A.9 were used to calculate the
 122 evolution of the degree of cure during the UV rheometer test using Equa-
 123 tions 1, 2 and 3 to analyse the viscoelastic material properties and chemical
 124 shrinkage as a function of the degree of cure and temperature. Furthermore,
 125 the degrees of cure of the solid samples tested in DMA in Section 4 were cal-
 126 culated using the residual specific heat of reaction h_r measured by classical
 127 DSC measurements and the total specific heat of reaction h_{tot} obtained by
 128 photo-DSC as follows:

$$q = 1 - \frac{h_r}{h_{tot}} \quad (4)$$

129 2.3. Linear viscoelasticity characterization

130 The viscoelastic behaviour of the materials is studied through dynamic
 131 tests in which the stress (or strain) resulting from a sinusoidal strain (or
 132 stress) is measured in torsional mode. When a viscoelastic material is con-
 133 tinuously subjected to a sufficient small sinusoidal shear strain $\gamma(t)$, a steady
 134 state will eventually be attained in which the resulting shear stress in the
 135 sample $\tau(t)$ is also sinusoidal, with the same angular frequency ω but out of
 136 phase with the imposed strain by a shift angle δ . The current temperature
 137 and degree of cure of the polymer, as well as the applied angular frequency
 138 during loading generally have an impact on the measured phase shift δ . If the
 139 origin along the time axis is chosen to coincide with the point of maximum
 140 strain, the constitutive equation of the stress and strain functions reads as
 141 [40]:

$$\gamma(t) = \gamma_0 \sin(\omega t) \quad (5)$$

$$\tau(t) = \tau_0 \sin(\omega t + \delta) \quad (6)$$

143 where γ_0 and τ_0 are the amplitude of the shear strain and shear stress, re-
 144 spectively. It is convenient to transfer the stress and strain functions into the
 145 frequency domain as their complex quantities using the algebraic operations
 146 used in harmonic systems:

$$\gamma^* = \gamma_0 \exp(i\omega t) \quad (7)$$

$$\tau^* = \tau_0 \exp(i(\omega t + \delta)) \quad (8)$$

148 Based on these harmonic relations, one can define the complex shear modulus
 149 G^* and two different dynamic moduli with their quotient:

$$G^* = \frac{\tau^*}{\gamma^*} = \frac{\tau_0}{\gamma_0} \cos(\delta) + i \frac{\tau_0}{\gamma_0} \sin(\delta) \quad (9)$$

150

$$G' = \frac{\tau_0}{\gamma_0} \cos(\delta) \quad (10)$$

151

$$G'' = \frac{\tau_0}{\gamma_0} \sin(\delta) \quad (11)$$

152

$$\tan(\delta) = \frac{G''}{G'} \quad (12)$$

153 The shear storage modulus G' describes the mechanical energy stored by the
 154 material during a loading cycle which represents the reversible part of the
 155 dynamic mechanical material behaviour after a load cycle. The loss modulus
 156 G'' accounts for the ability to dissipate the mechanical energy through in-
 157 ternal molecular motions. The damping factor $\tan(\delta)$ represents the ratio of
 158 the viscous and the elastic portion of the viscoelastic deformation behaviour.

159 The following sections provide an overview of the various oscillatory tests
 160 with controlled shear strain that were conducted utilising this complex math-
 161 ematical form to measure and predict the viscoelastic properties and chemical
 162 shrinkage of the photopolymer.

163 *2.4. Methods*

164 *2.4.1. UV rheometry*

165 The UV rheometry measurement permits the monitoring of the evolution
 166 of the viscoelastic properties in the gel-sol transition of the photopolymer
 167 resin. Figure 2 shows a schematic representation of the experimental pro-
 168 cedure and the UV curing progress of the liquid resin sandwiched between
 169 the parallel-plate measuring system consisting of a transparent bottom plate
 170 made of quartz glass.

171 The investigation of the evolution of the viscoelastic properties and the
 172 chemical shrinkage of PR48 resin during the UV curing was carried out
 173 with the hybrid rheometer Discovery HR-3 (TA Instruments, New Castle,
 174 DE, USA) upgraded with the OmniCure[®] S2000 UV light source (Exceli-
 175 tas, Waltham, MA, USA). A parallel plate measuring system consisting of
 176 a quartz plate and a disposable aluminium top plate with a diameter of 20
 177 mm was used.

178 The measurement gap was adjusted to 500 μm . The measurement gap of
 179 $d_{gap} = 500 \mu\text{m}$ was determined through preliminary tests performed to de-
 180 termine appropriate experimental test parameters. The PR48 photopolymer
 181 resin cures rapidly even at low UV light intensity and room temperature,

182 and hardens into a very stiff substance. Therefore, when a thinner layer of
183 photopolymer was used between two parallel plates, the cured solid polymer
184 prevented oscillation through the top plate. As a result, the maximum allow-
185 able torque specified for the test instrument was reached and the test stopped.
186 In such a short period of time, it is not feasible to monitor the change in the
187 viscoelastic properties and decrease in the measurement gap for the chemical
188 shrinkage of the material during UV curing. This selected thickness corre-
189 sponds to approximately 5 to 10 times the typical layer thickness provided
190 by conventional SLA and DLP 3D printers used to print photopolymer parts
191 [2]. As mentioned in Section 5 later, the agreement between the maximum
192 shrinkage determined by UV rheometer tests and determined by density mea-
193 surements in static mode [37] indicates that the transverse shrinkage of the
194 polymer is negligible at this layer thickness.

195 The UV light intensity was adjusted to $\mathcal{I}_0 = 10.12 \text{ mW/cm}^2$ at the top
196 surface of the quartz plate for all tests. For each selected isothermal test, the
197 temperature of the upper aluminium plate was set to the desired tempera-
198 ture before the photopolymer resin was applied onto the quartz plate. For
199 the measurement gap of $500 \text{ }\mu\text{m}$, a liquid photopolymer sample volume of
200 approximately $157 \text{ }\mu\text{L}$ was carefully injected with a pipette onto the quartz
201 glass plate. An isothermal step was applied at the test temperature for 10
202 minutes for stabilization at each measurement point.

203 The measurement of the rheological properties were performed in the
204 auto-strain mode with an initial strain of $\gamma_0 = 0.1\%$. The auto-strain fea-
205 ture was programmed to automatically adjust the strain amplitude to mate-
206 rial changes in the linear viscoelastic region of the least cured solid sample
207 ($q = 0.63$) in Section 4.1. To avoid the breaking of the polymer network, the
208 strain amplitude increased to the maximum allowable value at the beginning
209 of the curing and then decreased with progressing crosslinking when gelation
210 starts. In other words, auto-strain adjustment was used to improve signal
211 quality throughout a single experiment, as the optimal measurement condi-
212 tions for a liquid material are not the same as those for a rigid solid. The
213 adjustment amplitude range was selected from $\gamma_0 = 0.01\%$ to 1% according
214 to the amplitude sweep tests. The normal force is set to $0 \pm 0.1 \text{ N}$ to minimize
215 the effect of the excessive tensile stresses generated by chemical shrinkage.

216 2.4.2. *Dynamic mechanical analysis*

217 Dynamic mechanical analysis (DMA) is a conventional measurement tech-
218 nique in which the elastic and viscous responses of the polymer materials

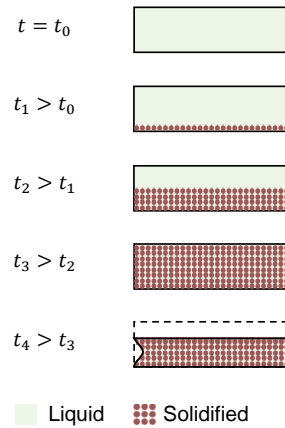
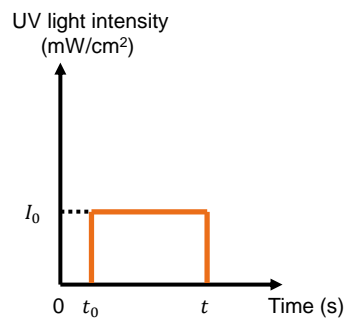
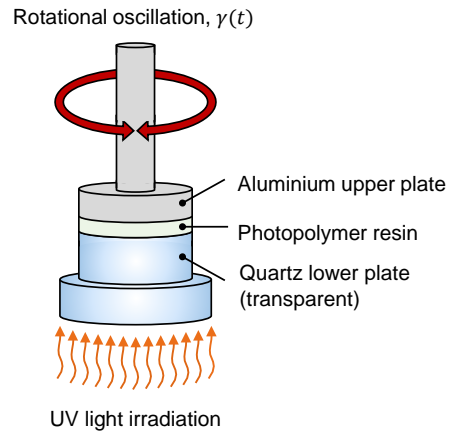
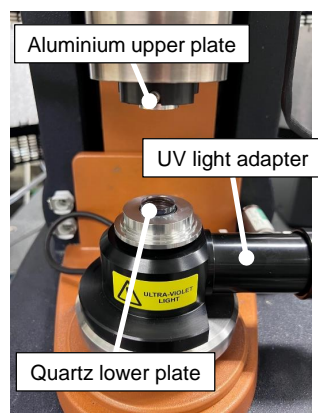

Figure 2: Outline of the UV rheometry experiment. Top left: Experimental setup of the Discovery HR-3 rheometer with the parallel plates. Top right: Schematic representation of the experimental setup under the oscillatory conditions and UV irradiation. Bottom left: Irradiation of constant UV light over time during the crosslinking process. Bottom right: Schematic representation of the curing process in the liquid photopolymer between the parallel plates during the UV irradiation.

219 subjected to a sinusoidal oscillatory force are monitored over temperature,
 220 time, frequency or amplitude sweeps.

221 In this work, DMA was employed to study the viscoelastic behaviour of
 222 the solid PR48 photopolymer samples in torsion mode. Amplitude, temper-
 223 ature and frequency sweep tests were run on a modular rheometer MCR502
 224 (Anton Paar, Graz, Austria) with an integrated environmental chamber CTD

225 600 (by Anton Paar) which was used with air and nitrogen. A solid rectangular
 226 lar fixture system SRF5 (by Anton Paar) was used for all the experiments in
 227 this section with force-controlled measurements. A normal force of 1 N was
 228 applied in tension mode to prevent the specimens from buckling or excessive
 229 tensile forces due to thermal expansion and contraction when the material is
 230 tested over a wide temperature range. The top of the specimen was subjected
 231 to a controlled shear strain given in Equation 5 while the bottom is fixed as
 232 outlined in Figure 3.

233 Rectangular photopolymer samples were prepared by injecting the liquid
 234 resin between two glass slides separated by Teflon molds in order to cure
 235 in the UV chamber named UVP Crosslinker CL-1000L (Analytik Jena AG,
 236 Jena, Germany). According to the standard ISO 6721-2 [41], specimens
 237 with the dimensions of $50 \times 10 \times 1 \text{ mm}^3$ (length \times width \times thickness) were
 238 manufactured by exposing them to UV light for 3, 8, 30 and 540 min.

239 Moreover, before DMA testing, the samples were analysed at least 3 times
 240 in a DSC to determine the average degree of cure listed in Table 1 using
 Equation 4.

Table 1: Degree of cure q of the samples for the DMA measurements based on the light exposure time t_{exp} .

t_{exp} [mins]	3	8	30	540
q [-]	0.63	0.89	0.92	0.96

241

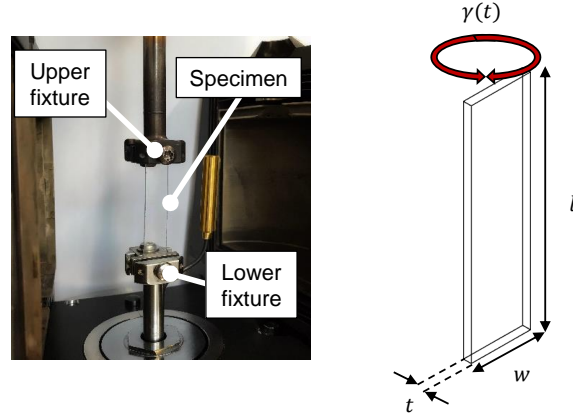

Figure 3: Outline of the DMA experiments in torsional mode. Left: Specimen mounted in Anton Paar MCR 502 rheometer where the shear excitation is applied to the top of the specimen by the upper mobile fixture. Right: Schematic of rectangular sample with dimensions of $50 \times 10 \times 1 \text{ mm}^3$ ($l \times w \times t$) used in DMA tests according to ISO 6721-2 standards.

242 **3. Evolution of the viscoelastic properties during the UV curing**
 243 **reaction**

244 *3.1. Time sweep tests*

245 Time sweep tests for 400 s were performed at different constant frequen-
 246 cies ($f = 0.1, 1, 10, 100 \text{ Hz}$) at constant UV intensity and at several isothermal
 247 conditions ($\theta = 10, 20, 30, 40, 50, 60 \text{ }^\circ\text{C}$). The onset time of UV light exposure
 248 was set to 60 s for all tests.

249 The direct experimental results of the change in the storage modulus G'
 250 for all measurements are provided in Appendix B. As shown in the schematic
 251 representations in Figure 2, initially, the photopolymer resin is conditioned
 252 with sinusoidal shear excitation given by Equation 5 at constant frequency
 253 $f = \omega/2\pi$, constant strain amplitude γ_0 , and isothermal condition θ for up
 254 to $t_0 = 60 \text{ s}$ ($0 < t < t_0$). Then, UV light is activated unidirectionally from
 255 the bottom of the quartz plate upwards ($t = t_0$). Furthermore, curing starts
 256 at the bottom of the photopolymer layer ($t = t_1$) and then progresses in
 257 the vertical direction ($t_1 < t < t_2$). When the solidifying photopolymer layer
 258 reaches to the aluminium top plate ($t = t_3$), the rheometer begins to measure
 259 the changes in the viscoelastic material properties. Since the curing front
 260 takes some time to reach the top plate where the measurement is performed,

261 a short delay is noticed in the $G' - t$ plot, between the activation of the UV
262 light and the onset of the rise of the shear storage modulus. Therefore, it
263 is necessary to shift all the curves presented in Appendix B such that the
264 storage modulus of G' starts to increase, i.e. the curing starts at $t = 0$ as
265 shown in Figure 4.

266 The experimental findings of the change in the shear storage modulus G'
267 for frequency values in four different orders of magnitude and at six different
268 isothermal conditions are depicted in Figure 4. All measurements show a
269 rapid increase in the presence of UV light irradiation, in addition to different
270 evolutions of the shear storage moduli due to frequency-dependent material
271 behaviour. The shear storage modulus of the progressively cured sample
272 reaches its plateau value more rapidly as the frequency value increases. It
273 can be seen that the value of the maximum shear storage modulus obtained
274 is higher than the tests performed at lower frequency. This can be explained
275 by the faster curing of the sample due to lower viscosity as the frequency
276 increases. Consequently, achieving a higher degree of cure due to the lower
277 viscosity also leads to a higher storage modulus at the end of the test. In
278 the literature, this relationship between low viscosity and high degree of cure
279 has also been observed for dual-cured resin cement [42]. As the degree of
280 cure or curing time increases, the difference between the curves belonging to
281 different frequencies in the semi-logarithmic representation decreases.

282 The constant temperature applied to the photopolymer in the tests leads
283 to two opposing mechanisms. In the first case, higher temperature increases
284 the rate of crosslinking of the photopolymer and allows for a higher degree of
285 cure at the end of the chemical reaction. As a consequence, the photopoly-
286 mer sample reaches a higher shear storage modulus at the end of the test.
287 In the second case, higher temperature causes a lower shear storage modulus
288 and thus the photopolymer sample becomes softer. These two mechanically
289 and chemically coupled mechanisms occur concurrently and cannot be dis-
290 tinguished in UV rheometer experiments. As shown in Figure 4, in the tests
291 performed at temperatures between 10 °C and 40 °C, the increase in temper-
292 ature accelerates the curing reaction, resulting in the shear storage modulus
293 to reach its plateau value earlier. However, the temperature-induced acceler-
294 ation of curing is not comparable in the experiments performed at tempera-
295 tures between 40 °C and 60 °C. At the end of the tests carried out at $\theta = 50$
296 °C and 60 °C, it was observed that the samples obtained at the end of the
297 curing reaction were soft, especially in the tests carried out at $f = 0.1$ Hz,
298 and therefore the bottom quartz glass and top aluminium plates could be

299 easily separated.

300 3.2. Gelation point

301 The degree of cure at the gelation point q_{gel} is required for the applica-
302 tion of the time-cure superposition principle in the description of viscoelastic
303 properties during the entire UV curing reaction. Therefore, it is necessary to
304 calculate the evolution of the degree of cure given in Equation 2 as a function
305 of temperature, UV light, and time during the UV rheometer test.

306 We further consider that the UV light intensity decreases exponentially
307 with the layer thickness as it passes through the liquid photopolymer medium,
308 according to the Beer-Lambert law described by the following equation [20]:

$$\mathcal{I}(z) = \exp\left(-\frac{z}{D_p}\right) \mathcal{I}_0 \quad (13)$$

309 where $\mathcal{I}(z)$ is the light intensity as a function of distance z , D_p denotes
310 the penetration depth, which was determined to be $D_p = 223.2 \mu\text{m}$ in the
311 previous study in which the UV curing properties of the PR48 photopolymer
312 resin were examined in detail [37] and $\mathcal{I}_0 = 10.12 \text{ mJ}/\text{cm}^2$ is the UV light
313 intensity on the quartz glass plate. The average value of UV light intensity
314 \mathcal{I}_{av} between parallel plates was used to calculate the effective degree of cure.
315 Using Equation 13, the following mean value is computed:

$$\mathcal{I}_{av} = \frac{1}{d_{gap}} \int_0^{d_{gap}} \mathcal{I}(z) dz \quad (14)$$

316 The average light intensity was calculated as $\mathcal{I}_{av} = 4.04 \text{ mW}/\text{cm}^2$. This value
317 is close to $\mathcal{I} = 5 \text{ mW}/\text{cm}^2$ which is one of the two UV light intensity values in
318 which the photocalorimetric tests were performed in the previous work [37].
319 The evolution of the degree of cure during UV rheometer tests was estimated
320 using Equations 2 and 3 and the corresponding maximum attainable degree
321 of cure q_{max} . Figure 5 depicts the evolution of the effective degree of cure for
322 the UV rheometer measurements.

323 The gelation point is defined as the transition point of a crosslinking
324 polymer from a liquid to a solid [43]. There are two commonly used methods
325 for estimating the gelation point of the photopolymer layer.

326 According to ASTM standard D4473 [44], the gelation point (t_{gel}) is de-
327 fined as the point at the intersection of the curves of G' and G'' versus time
328 t ($G' = G''$). This state shows the borderline of a crosslinking polymer liquid

329 transforming into a solid [45]. This point can be determined by the oscilla-
 330 tory tests performed in the linear viscoelastic range during the crosslinking
 331 reaction. In the ASTM standard D4773, the frequency to evaluate the curing
 332 behaviour of thermosets is recommended to be set to $f < 1.5$ Hz. In accor-
 333 dance with this standard, the evolution of the viscoelastic properties (G' , G'')
 334 at $f = 1$ Hz and $\theta = 20$ °C are plotted in Figure 5. It can be seen from the
 335 plot that as the sample passes gelation point, both storage and loss moduli
 336 start to increase until the maximum attainable degree of cure is reached.
 337 From the zoomed window in the same figure, it can be seen that the gelation
 338 point (t_{gel}) of the PR48 was reached at $t = 7.93$ s after starting the UV irra-
 339 diation. The UV energy dose reached at this point is $E_{gel} = 32.04$ mJ/cm².
 340 The degree of cure at the gelation point was calculated as $q_{gel} = 0.32$ using
 341 the model equation of the degree of cure with the test parameters.

342 The second method utilizes the working curve model developed by Jacobs
 343 [46]. According to this model, the relationship between the applied UV light
 344 exposure dose $E = \mathcal{I} \times t$ and the resulting cured depth C_d of the photopolymer
 345 layer is defined by deriving from the Beer-Lambert law (Equation 13) as
 346 follows:

$$C_d = D_p \ln \left(\frac{E}{E_c} \right) \quad (15)$$

347 Here, the critical exposure energy E_c represents the amount of UV light
 348 exposure dose required to solidify the photopolymer at the gelation point.
 349 $E_c = 30.63$ mJ/cm². The experimental procedure and methodology for de-
 350 termination of the critical exposure energy doses were detailed in the previous
 351 article [37]. As a consequence, this yields the time point at $t_{gel} = 7.58$ s which
 352 gives almost the same gelation point q_{gel} as the first approach.

353 3.3. Time-cure superposition

354 The experimental results of the storage modulus in the time domain were
 355 combined with the model equations for the degree of cure. The evolution of
 356 the degree of cure during the UV rheometer test was calculated using Equa-
 357 tions 2 and 3 for the specified temperature and UV light intensity conditions.
 358 This coupling yields several subcurves of the shear storage modulus in the
 359 frequency domain depending on the degree of cure, as shown in Figure 6. In
 360 this graph, it can be seen that as the temperature increases, two conflicting
 361 phenomena occur, similar to those observed in Figure 4 for the photopolymer
 362 sample. The increase in temperature leads to an acceleration of the crosslink-
 363 ing process of the photopolymer, resulting in a higher degree of cure in the

364 same period of time. In this case, the photopolymer is expected to reach
365 a higher shear storage modulus at the end of the higher temperature mea-
366 surement. It is important to note, however, that increasing temperature also
367 cause another phenomenon. As the temperature rises, the kinetic energy of
368 the polymer increases, leading to an increase in the mobility of the polymer
369 chains. This increased mobility of polymer chains results in a decrease in
370 the storage modulus. As a result, in the subcurves presented for $t = 0 - 250$
371 s, the curves of storage modulus fall within the same range after a certain
372 time due to these opposite phenomena. Master curves were created by man-
373 ually shifting these subcurves in the first 50 seconds of these measurements
374 to perform time-cure superposition similar to the work of Adolf and Martin
375 [47] and Eom et al. [48].

376 The shift factor exponents to the base 10 s_q calculated for the measure-
377 ments performed at different isothermal conditions are presented in Figure 7.
378 The shift factors are almost independent of temperature up to $q = 0.52$ in
379 spite of a spread of values. Eom et al. [48] identified the gelation point at
380 this value which is not the case here, as the gelation point was identified
381 previously at $q_{gel} = 0.32$. This difference can be explained by the nonlinear
382 effect on the evolution of the shift factors as the degree of cure approaches its
383 maximum value $q_{max}(\mathcal{I}, \theta)$. In future studies, this point can be rheologically
384 investigated in order to perform a general and valid material modelling that
385 takes into account the effect of temperature and $q_{max}(\mathcal{I}, \theta)$ during UV curing.

386 In the next step, experimental results at $\theta = 20$ °C were selected as an
387 ideal case to model the degree of cure- and temperature-dependent viscoelas-
388 tic properties of the material by combining the DMA and UV rheometer mea-
389 surements. Since the lowest degree of cure tested in DMA in Section 2.4.2
390 was $q = 0.63$ which corresponds to the first 40 seconds of the measurement,
391 a master curve was built from curves up to this value at $q_{ref} = 0.53$ and
392 given in Figure 8. This master curve shows that as the degree of cure and
393 frequency increase, the shear storage modulus also increases.

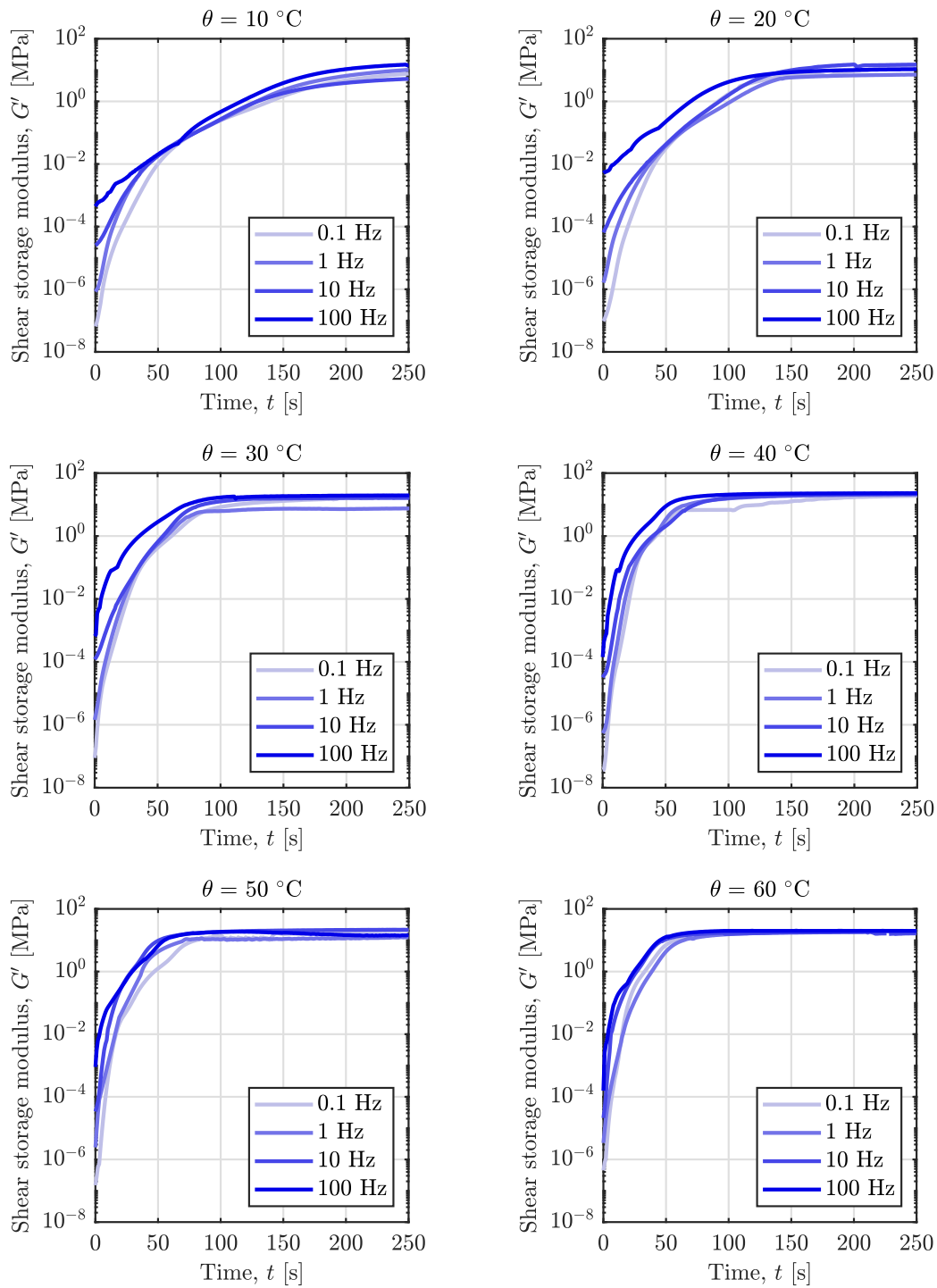

Figure 4: Evolution of the shear storage modulus G' with progressing crosslinking in the photopolymer layer at different isothermal conditions and frequencies (plotted for $t = 0 - 250$ s for better visualization). 16

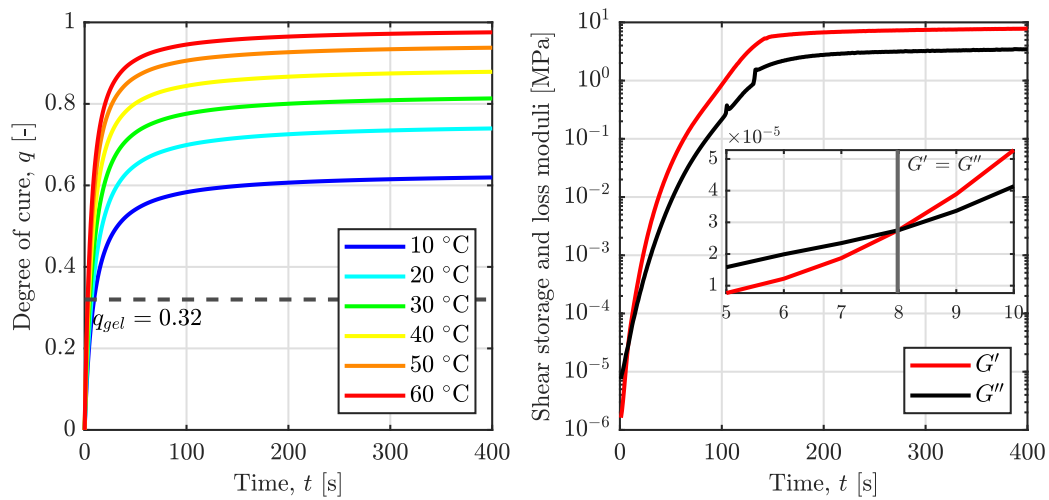

Figure 5: Left: Evolution of the degree of cure q in the UV rheometry measurements during the crosslinking calculated by Equations 2 and 3 with the identified parameters given in Tables A.8 and A.9. Right: Determination of time instant of the gelation point where $G' = G''$ equilibrium is satisfied according the ASTM D4473.

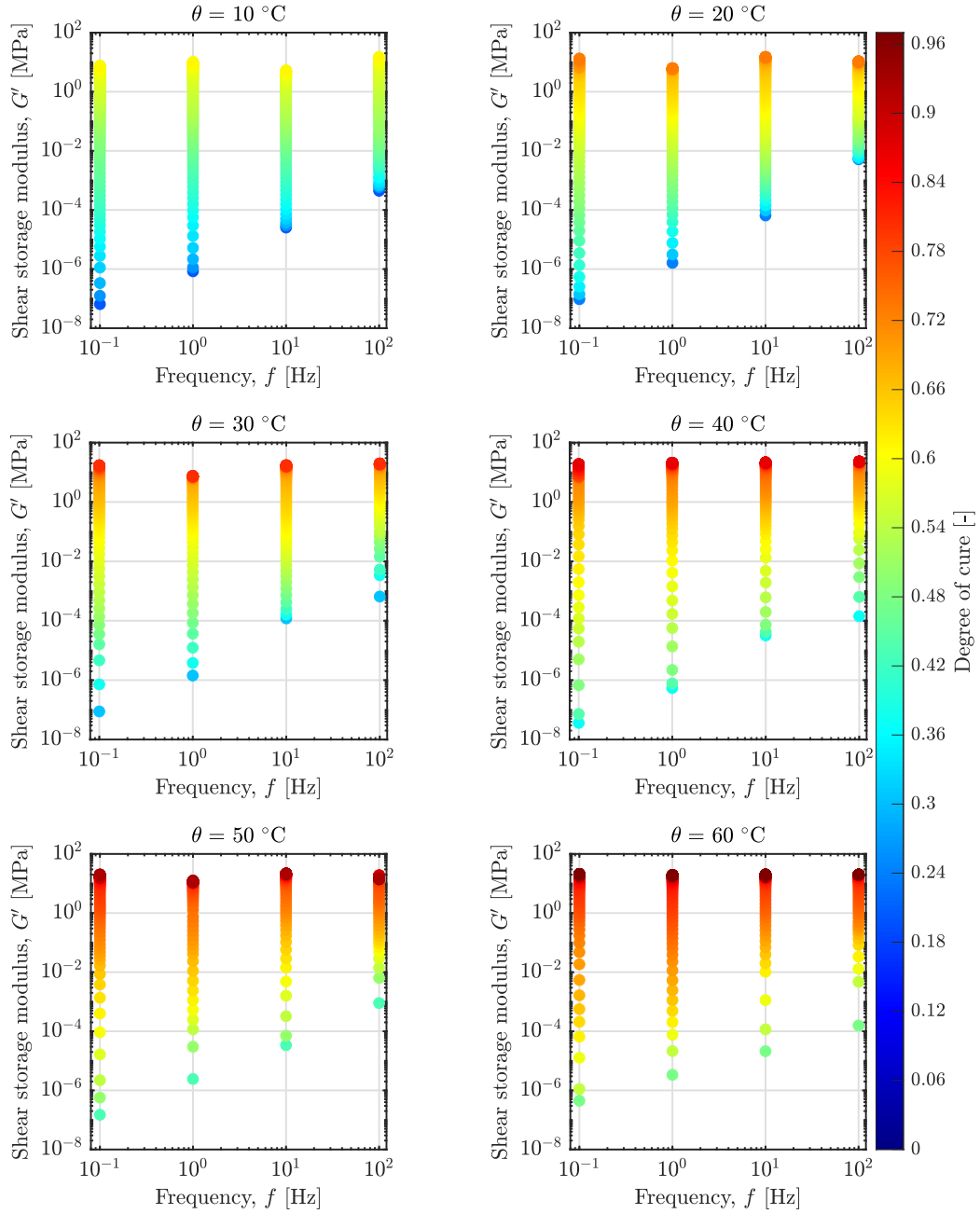

Figure 6: Transformation of the curves of the shear storage modulus in Figure 4 into the frequency domain using the model equation of the degree of cure at various constant degree of cure (plotted for $t = 0 - 250$ s).

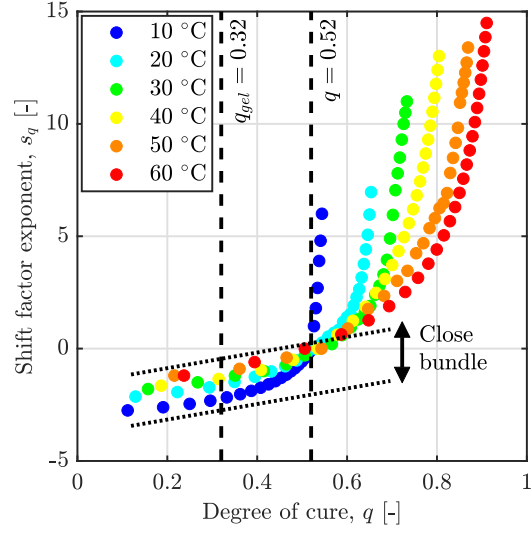

Figure 7: Shift factor exponents to the base 10, $s_q(q)$, as a function of degree of cure q obtained by manual shifting at $q_{ref} = 0.53$ to build the master curves based on the UV rheometer measurements in the first 50 seconds.

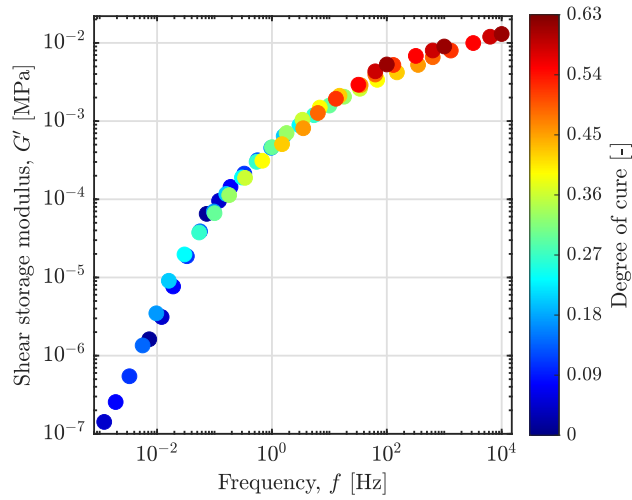

Figure 8: Resulting master curve after shifting the subcurves of Figure 6 at $\theta = 20\text{ }^\circ\text{C}$ at $q_{ref} = 0.53$ for the first 40 seconds (time point corresponding to $q = 0.63$).

394 **4. Evolution of the viscoelastic properties after the UV curing re-**
395 **action**

396 *4.1. Amplitude sweep tests*

397 In this study, the preset of a strain sweep (also called shear strain am-
398 plitude sweep) was chosen with a controlled shear strain $\gamma_0(t) = \gamma_0 \sin(\omega t)$
399 with a constant angular frequency $\omega = 2\pi f$ and a variable strain amplitude
400 increasing with time $\gamma_0 = \gamma_0(t)$. Strain amplitude tests ranging from 0.01%
401 to 10% were carried out for specimens with 4 different degrees of cure at a
402 constant temperature of $\theta = 20$ °C and a frequency of $f = 1$ Hz. For data
403 acquisition, five data points per decade were distributed evenly using a log-
404 arithmic rule. The tolerance range of deviation for G' and G'' was selected
405 $\pm 10\%$ around the plateau value according to ASTM D7175 and DIN 51810-2
406 [49, 50]. In other words, all the dynamic moduli values less than 90% of the
407 plateau value were assessed to be outside the linear viscoelastic region.

408 The experimental results of specimens cured at different levels are dis-
409 played in Figure 9. The damping factors are provided in Appendix C.1. This
410 plot indicates that the storage and loss moduli are independent of the applied
411 strain amplitude under cyclic loading at small strains for all specimens. Fur-
412 thermore, as the degree of cure increases, the plateau values increase for the
413 storage moduli. This difference in moduli is that higher crosslinked material
414 tends to be harder and stiffer. The storage and loss moduli values remained
415 within the tolerance value of $\pm 10\%$ provided in the test standards, up to
416 the strain values of $\gamma_0 = 1.586\%$ for $q = 0.63, 0.89, 0.92$ and $\gamma_0 = 1\%$ for
417 $q = 0.96$. A nonlinear effect occurs when strains exceed these limiting val-
418 ues, and the dynamic material properties become strain dependent. When
419 cured, the PR48 resin becomes a hard and brittle material and presents a
420 brittle fracturing at strain values greater than $\gamma_0 = 1.586\%$. The plateau
421 values and limiting strain values of the storage and loss moduli in the linear
422 viscoelastic region are summarized in Table 2. The optimal amplitude should
423 be chosen smaller than the limiting value ($\gamma_{0_{lim}} = 1\%$) in order to carry out
424 the measurements in the linear regime. A value of $\gamma_0 = 0.1\%$ was chosen
425 for the temperature and frequency sweep tests in the following sections to
426 prevent the formation of micro- and macro-cracks throughout the test since
427 the material is hard and brittle.

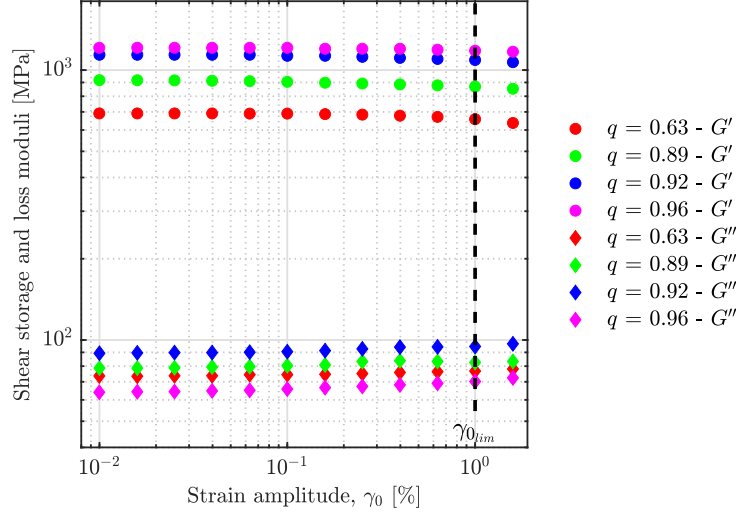

Figure 9: Storage and loss moduli as a function of strain amplitude at $f = 1$ Hz and $\theta = 20$ °C for the samples with $q = 0.63, 0.89, 0.92, 0.96$.

Table 2: Dynamic material properties and limiting value $\gamma_{0_{lim}}$ of linear viscoelastic region obtained as a result of strain scanning of samples with different degrees of cure q .

q [-]	G' [MPa]	G'' [MPa]	$\gamma_{0_{lim}}$ [%]
0.63	679.914 ± 22.238	74.982 ± 1.538	1.586
0.89	896.172 ± 11.356	81.064 ± 2.783	1.586
0.92	1120.283 ± 17.117	91.915 ± 2.616	1.586
0.96	1204.327 ± 9.773	66.331 ± 2.353	1.001

4.2. Temperature sweep tests

Temperature sweep tests were conducted in the temperature range from -110 °C to 160 °C for samples with different curing states. At the start of the experiment, the test chamber was cooled down to -110 °C by applying a 20-minute isotherm to ensure the temperature stability of the sample. Then, the experiments were run at a heating ramp of 1 °C/min, with a constant frequency of $f = 1$ Hz and a strain amplitude of $\gamma_0 = 0.1\%$. The viscoelastic material properties were measured at a data point step every 0.5 °C.

Figure 10 depicts the evolution of the shear storage modulus and the damping factor, G' and $\tan(\delta)$, as a function of temperature for samples at

438 various cured states. The distribution of the storage modulus is increasing
 439 with increasing degree of cure, if $\theta > -40$ °C. This plot also demonstrates
 440 that the glass transition occurs at a wide range of temperatures, from about
 441 -40 °C to 140 °C. This temperature range has been chosen as the range of
 442 interest for the frequency sweep tests given in the Section 4.3.

443 Furthermore, an increase in the shear storage moduli of the samples with
 444 $q = 0.63$ and 0.89 was observed after 140 °C. This increase is due to thermal
 445 curing of free monomers.

446 All samples undergo a thermal transition before -90 °C and after 60
 447 °C in the glassy state, denoted as β - and α -transition, respectively. The
 448 β -transition temperatures are around $\theta_\beta = -92$ °C, as listed in Table 3.
 449 On the one hand, it can be stated that the β -transition temperature θ_β is
 450 almost independent of the degree of cure q within the curing range of tested
 451 specimens in the DMA. On the other hand, the glass transition temperature
 452 is strongly dependent on the curing and rises with the degree of cure, see
 453 Table 3.

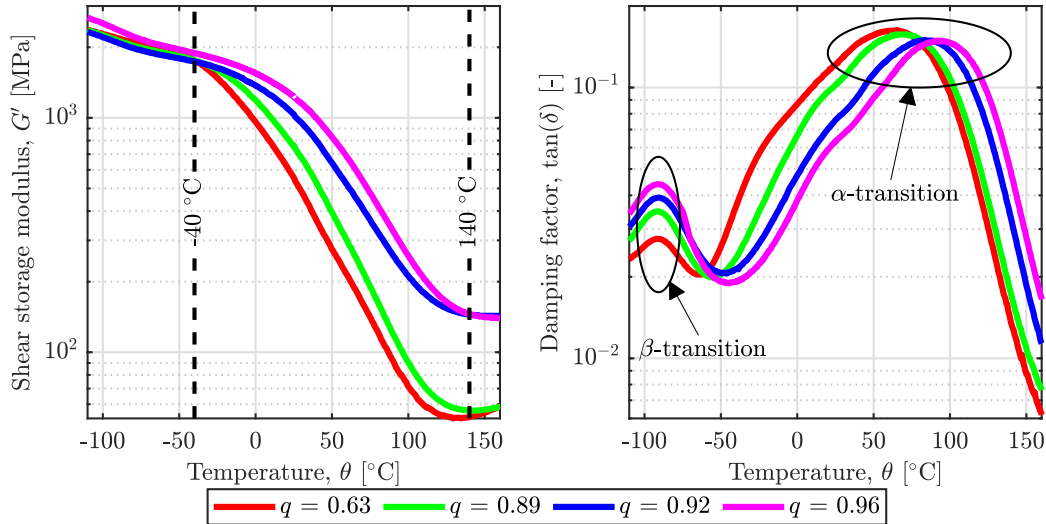

Figure 10: DMA thermograms of the cured polymers. Left: storage loss moduli, right: damping factors as a function of temperature at $f = 1$ Hz and $\gamma = 0.1\%$ at a heating rate of 1 °C/min for the samples cured at different levels.

454 4.3. Frequency sweep tests

455 Frequency sweep tests were carried out for materials in different curing
 456 states for isothermal conditions ranging from -40 °C to 140 °C at certain

Table 3: Thermal transition temperatures for the samples cured at different levels (θ_β : β -relaxation temperature, θ_α : glass transition (α -relaxation) temperature).

Degree of cure, q [-]	θ_β [°C]	θ_α [°C]
0.63	-92.4	68.9
0.89	-91.4	73.1
0.92	-91.4	83.4
0.96	-91.4	92.5

457 intervals. As the slopes of the dynamic moduli are expected to be more pro-
 458 nounced in this temperature range as presented in Figure 10 as a consequence
 459 of the temperature sweep tests, a 10 °C temperature step was selected to have
 460 better resolution in the range of the thermal transitions. For each isothermal
 461 frequency sweep test, a 10-minute isothermal step was performed to ensure
 462 temperature stabilization of the sample before performing the dynamic test.
 463 The frequency scanning range was 0.01 to 10 Hz, with five measuring points
 464 each decade equally distributed on a logarithmic scale. The applied strain
 465 amplitude was $\gamma_0 = 0.1\%$ for all samples as specified in Section 4.1.

466 The corresponding results of the shear storage modulus G' measured from
 467 isothermal frequency sweeps are shown in Figure 11 for four samples at dif-
 468 ferent curing condition. The shear loss modulus G'' isothermal curves as a
 469 function of frequency for all samples are given in Appendix C.2. It can be
 470 observed that the highly cured samples at low temperatures show almost the
 471 same value of G' . It can be concluded that further lowering the temperature
 472 for less cured samples leads to the same plateau value of the storage modulus
 473 in the glassy case where we have frequency independent material properties in
 474 the high frequency region ($G' \approx 2000$ MPa). The storage modulus begins to
 475 decrease as the temperature rises. At higher temperatures, the shear storage
 476 modulus decreases faster as the degree of cure decreases. Furthermore, the
 477 equilibrium modulus at the highest test temperature reduces with decreasing
 478 degree of cure ($\theta_{\max} = 140$ °C). In addition, the storage modulus increases
 479 after 120 °C for the sample with $q = 0.63$ and after 130 °C for the sample
 480 with $q = 0.89$, indicating thermal curing, as we observed after 140 °C in
 481 the temperature sweep test reported in Section 4.2. This is because samples
 482 are likely to begin thermally curing at lower temperatures, provided they
 483 have had sufficient time to reach the activation energy required for molecular

484 mobility during isothermal measurements.

485 The Cole-Cole diagram enables to determine whether a material has a
486 thermorheologically simple behaviour in order to construct its master curve
487 by applying the time-temperature superposition principle (TTSP) on the
488 frequency sweep test results performed at a certain temperature range [51].
489 Figure 12 shows Cole-Cole curves for four different samples. Cole-Cole di-
490 agrams appear continuous and smooth for all experimental data and show
491 that cured PR48 samples are thermorheologically simple in the temperature
492 range studied.

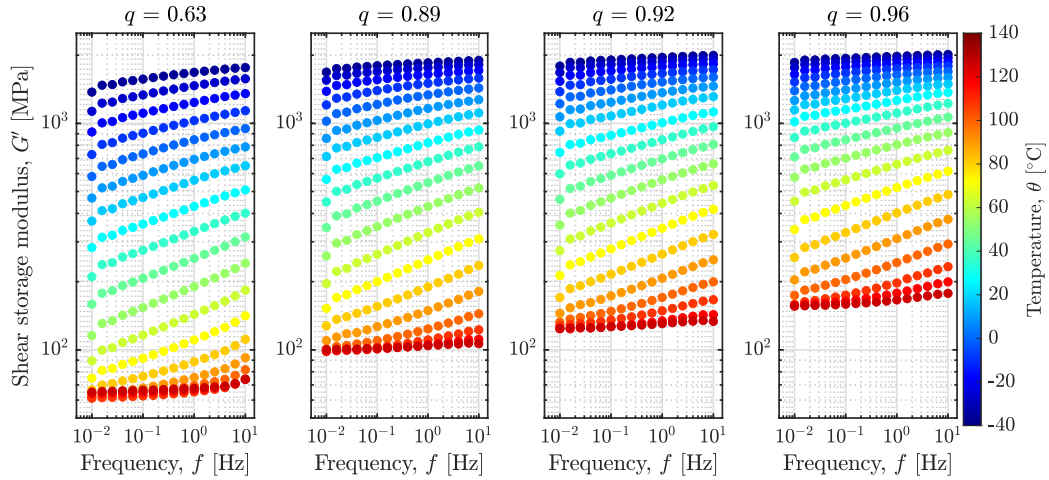

Figure 11: Isothermal frequency sweep curves of the shear storage modulus G' obtained from the DMA tests of the samples with different degrees of cure $q = 0.63, 0.89, 0.92, 0.96$.

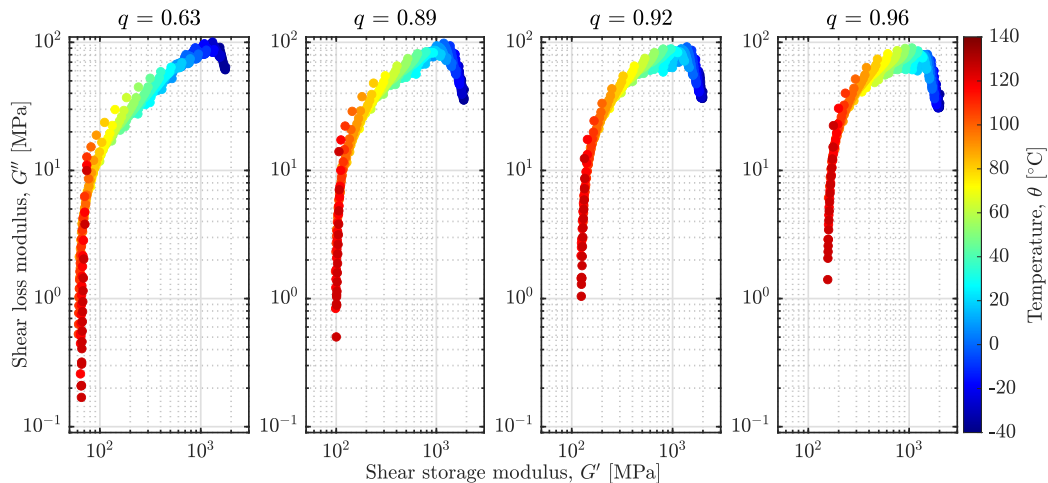

Figure 12: Cole-Cole curves (shear storage modulus G' vs. shear loss modulus G'') of the samples at different curing states. The measurement results were obtained through frequency sweep tests ($f = 0.01 - 10$ Hz) performed at isothermal conditions between -40 °C and 140 °C.

4.4. Time-temperature superposition

The time-temperature superposition principle (TTSP) was applied to the experimental measurements of the frequency sweep tests in order to achieve viscoelastic material characteristics over a broader frequency range. This application allowed for the construction of the master curve using mere horizontal shifts in the experimental data. For each sample with varying degree of cure, isothermal curves at $\theta_{ref} = 20$ °C were used as the reference for the generation of the master curves.

According to the TTSP, frequency sweep curves at lower temperatures were shifted to higher frequencies and vice versa. The resultant master curves of all samples at a reference temperature of $\theta_{ref} = 20$ °C are presented in Figure C.20.

Figure 13 shows the corresponding exponents to the base 10 of the shift factors for constructing the master curves at the reference temperature $\theta_{ref} = 20$ °C applying the TTSP. It should be emphasized that no explicit dependence on the degree of cure up to 90 °C was observed. The reason for the slight difference after 90 °C may result from the test temperature exceeding the glass transition temperature θ_{α} of the samples obtained by the temperature sweep tests in Section 4.2. Generally speaking, considering the Cole-Cole curve in Figure 12 and a temperature range chosen away from the

513 onset temperature of thermal curing ($\theta_{onset} = 120$ °C according to isothermal
514 frequency sweep experiments), these shift factors can be described with a
515 single equation based solely on temperature. This key aspect will enable the
516 time-temperature superposition principle to be represented independently of
517 the time-cure superposition principle in Section 4.6. As a result, the WLF
518 equation was concurrently adapted for all four independent datasets of shift
519 factors at each reference temperature as follows:

$$s_{\theta}(\theta) = \frac{-C_1 (\theta - \theta_{ref})}{C_2 + (\theta - \theta_{ref})} \quad (16)$$

520 where θ is the temperature of interest, θ_{ref} is the reference temperature cho-
521 sen to construct the master curve and C_1 and C_2 are the material constants.

522 The WLF parameters identified are $C_1 = 81.42$ and $C_2 = 595.8$ °C at
523 $\theta_{ref} = 20$ °C. The fitting curve obtained using the WLF equation to the
524 temperature-dependent shift factors calculated at $\theta_{ref} = 20$ °C is depicted in
525 Figure 13.

526 Figure C.20 also shows the master curves that were constructed by shift-
527 ing isothermal curves given in Figure 11 with the shift factors obtained from
528 the WLF equation. These curves obtained by the WLF equation were em-
529 ployed in the material modelling in the next sections to consider the inde-
530 pendence from degree of cure.

531 4.5. Identification of relaxation times and stiffnesses at the reference point

532 In this work, a degree of cure- and temperature-dependent generalized
533 Maxwell model is proposed to represent the measurement results given in
534 Section 4.4 for the time-cure superposition to be performed in the next sec-
535 tion. A schematic representation of a generalized Maxwell model with n
536 elements as a part of the rheological network is depicted in Figure C.21.

537 Depending on the temperature and the degree of cure, the shear storage
538 G' and the shear loss modulus G'' are defined as:

$$G'(\omega, G_i, \lambda_i) = G_{\infty}(q) + \sum_{i=1}^n G_i \frac{(\omega \lambda_i(\theta, q))^2}{1 + (\omega \lambda_i(\theta, q))^2} \quad (17)$$

539

$$G''(\omega, G_i, \lambda_i) = \sum_{i=1}^n G_i \frac{\omega \lambda_i(\theta, q)}{1 + (\omega \lambda_i(\theta, q))^2} \quad (18)$$

540 where G_{∞} is degree of cure-dependent equilibrium stiffness, λ_i are degree
541 of cure- and temperature-dependent relaxation times, and G_i are constant

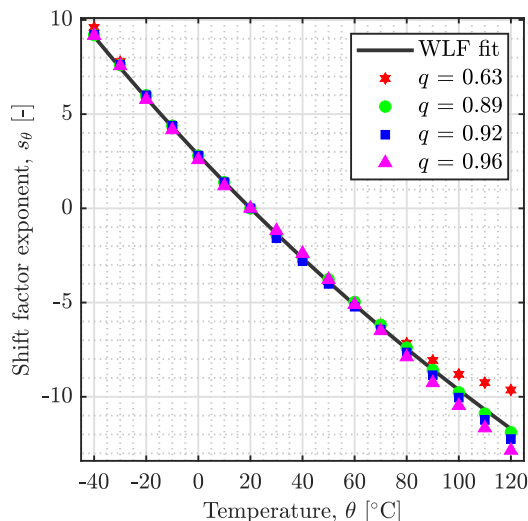

Figure 13: Shift factor exponents to the base 10 of time-temperature superposition at $\theta_{ref} = 20$ °C for samples with different degrees of cure (see Figure C.20) and fitted curve of these factors using the WLF equation.

542 stiffnesses for any temperature and degree of cure. The stiffnesses G_i and
 543 viscosities η_i for each Maxwell element are related to the relaxation time λ_i
 544 in such a way that:

$$\lambda_i = \frac{\eta_i}{G_i} \quad (19)$$

545 The number of Maxwell elements n is chosen as 30. The details of the
 546 selection method can be found in Appendix C.4.2.

547 4.6. Time-cure superposition

548 To account for changes in viscoelastic properties with temperature and
 549 curing, relaxation times λ_i are defined as a function of shift factors deter-
 550 mined by time-temperature s_θ and time-cure superposition s_q as follows:

$$\lambda_i(\theta, q) = \lambda_i^{ref} 10^{s_\theta(\theta) + s_q(q)} \quad (20)$$

551 where λ_i^{ref} indicates the relaxation times determined at the given reference
 552 temperature θ_{ref} and degree of cure q_{ref} .

553 The results are presented in Figure 14. This figure compares the mas-
 554 ter curves derived from the experimental findings with the curves simulated
 555 by identifying $\lambda_i(\theta, q)$ and $G_\infty(q)$. In this comparative graph, on the one

556 hand, the prediction of material behaviour at high frequencies, i.e. at low
 557 temperatures, showed a good agreement with the experimental data. On
 558 the other hand, especially for samples with lower degrees of cure, it was ob-
 559 served that the representation of the material behaviour was not sufficient as
 560 one goes towards low frequencies, i.e. at high temperatures. These regions,
 561 where the model estimation is weak, correspond to the curves obtained in the
 562 isothermal frequency sweep tests performed above the glass transition tem-
 563 perature θ_α in Section 4.3. It can be deduced that the proposed model does
 564 not provide a suitable estimation after glass transition temperature θ_α and
 565 it is recommended not to use the proposed time-cure superposition method
 566 in this region. Moreover, the identified equilibrium modulus $G_\infty(q)$ listed in
 567 Table 4 also indicate a considerable dependence on the degree of cure q .

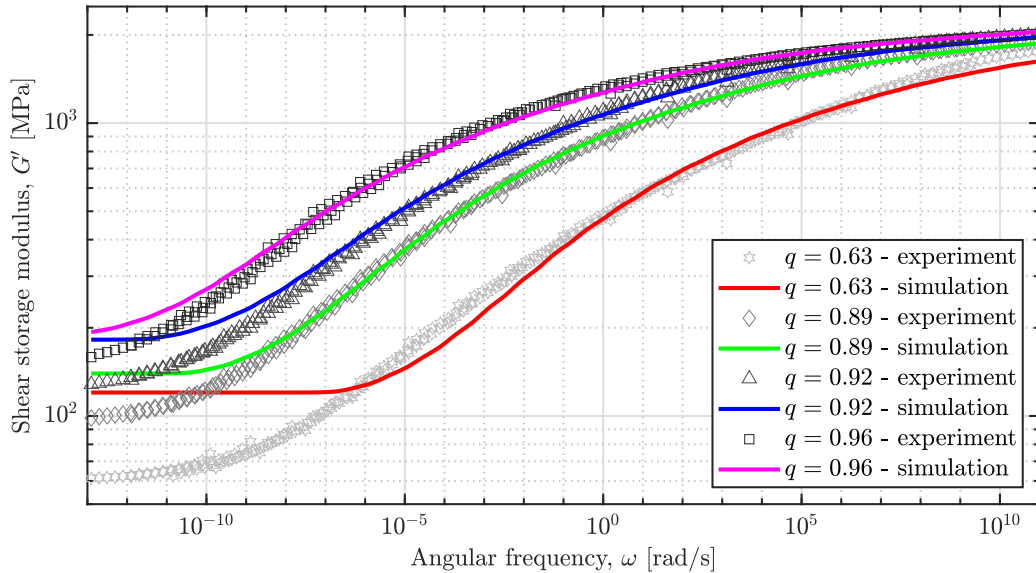

Figure 14: Experimental and simulated master curves at $\theta_{ref} = 20$ °C. After determining the parameters using the generalized Maxwell model at the reference point $q_{ref} = 0.96$ and $\theta_{ref} = 20$ °C, the time-cure superposition was applied to the curves for $q = 0.63, 0.89$ and 0.92 by shifting the relaxation times $\lambda_i(\theta, q)$ with certain shift factors $s_q(q)$ ($s_\theta(\theta_{ref}) = 0$) using Equation 20 and calculating the equilibrium moduli $G_\infty(q)$ depending on the degree of cure q .

Table 4: Degree of cure-dependent shift factors $s_q(q)$ and equilibrium moduli $G_\infty(q)$ identified according to the reference point $\theta_{ref} = 20$ °C and $q_{ref} = 0.96$.

q [-]	$s_q(q)$ [-]	G_∞ [MPa]
0.63	-6.551	120.248
0.89	-2.850	139.657
0.92	-1.764	182.233
0.96	0	189.754

568 The equilibrium shear modulus depending on the degree of cure, is rep-
 569 resented by the expression presented in [22, 52]:

$$G_\infty = G_{\infty 1} \exp(G_{\infty 2}(q - q_{gel})) + G_{\infty 3} \quad (21)$$

570 where $G_{\infty 1}$, $G_{\infty 2}$ and $G_{\infty 3}$ are fitting parameters and q_{gel} is the degree of cure
 571 at the gelation point ($q_{gel} = 0.32$). The identified fitting parameters are listed
 572 in Table 5. As presented in Figure C.24, the comparison of experimental
 573 and simulated results for the equilibrium modulus $G_\infty(q)$ reveals a good
 574 representation.

Table 5: Identified parameters of the degree of cure-dependent equilibrium modulus $G_\infty(q)$ given in Equation 21

Parameter	$G_{\infty 1}$ [MPa]	$G_{\infty 2}$ [-]	$G_{\infty 3}$ [MPa]	R^2 [-]
Value	0.067	11.01	116.9	0.871

575 4.7. Time-cure superposition for the entire curing process

576 To describe the evolution of viscoelastic material properties of the pho-
 577 topolymer during the entire crosslinking reaction, the shift factors from UV
 578 rheometer measurements can be combined with those from DMA measure-
 579 ments. To achieve this, the shift factors of the UV rheometer tests at $\theta = 20$
 580 °C given in Figure 7 were vertically and equally shifted downwards to build
 581 a continuous curve with the shift factors obtained from the DMA measure-
 582 ments (see Appendix D).

583 Rehbein et al. [23] effectively employed a mathematical formulation to
 584 describe the shift factors obtained for the time-cure superposition, drawing
 585 inspiration from the earlier work of Eom et al. [48]. In this mathematical

586 representation, the shift factor is represented as a function of degree of cure q
 587 by a linear equation before the gelation point q_{gel} , and then, the dependence
 588 of the shift factor on the degree of cure is described by a fitting function as
 589 follows:

$$s_q(q) = \begin{cases} s_{q1} (q - q_{gel}) + s_{q_{gel}}, & q < q_{gel} \\ s_{q_{gel}} \cdot s_{q2}^{q - q_{gel}} \left(\frac{q_{max} - q}{q_{max} - q_{gel}} \right)^{s_{q3}}, & q \geq q_{gel} \end{cases} \quad (22)$$

590 where $s_{q_{gel}}$ is the shift factor at the gelation point of the photopolymer and
 591 $s_{q_{gel}}$, s_{q1} , s_{q2} , and s_{q3} are dimensionless model parameters to be identified.

592 Table 6 lists the identified parameters for the entire curing process de-
 593 fined by Equation 22. Figure 15 displays the fitting results which indicates
 594 that this model equation reveals satisfactory agreement with the shift factors
 595 experimentally obtained by applying the time-cure superposition.

Table 6: Identified parameters of the time-cure shift functions $s_q(q)$ given in Equation 22.

Parameter	s_{q1}	s_{q2}	s_{q3}	$s_{q_{gel}}$
Value [-]	4.247	1.315	0.696	-10.17

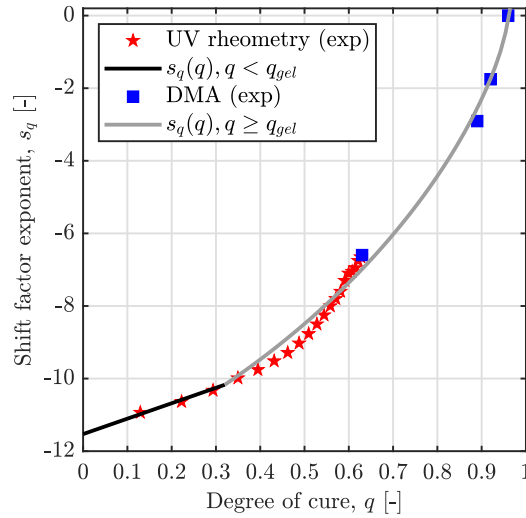

Figure 15: Representation of the time-cure shift factors calculated by the combination of UV rheometer and DMA measurement results and fitting curve obtained by the mathematical representation given in Equation 22.

596 **5. Polymerization shrinkage**

597 To estimate the chemical shrinkage caused by UV curing, the measure-
 598 ment gap change d_{gap} of the photopolymer layer over time was recorded
 599 in UV rheometer tests performed in Section 3.1. The temperature values
 600 ($\theta = 10, 20, 30, 40, 50, 60$ °C) are sufficiently lower than the onset temperature
 601 of thermal curing of the liquid photopolymer ($\theta_{onset} > 165$ °C) determined in
 602 the previous study [37]. Therefore, the effect of thermal curing is not involved
 603 in this study. The measurement results for $f = 1$ Hz were chosen to prevent
 604 dependence on low or high frequency and were motivated by investigations
 605 of chemical shrinkage measurement using UV rheometry [53, 54].

606 Considering the initial layer thickness $d_{gap}(0) = 500$ μm , the linear chem-
 607 ical shrinkage strain in the vertical direction of the liquid photopolymer sam-
 608 ple is expressed as:

$$\frac{\Delta L}{L}(t) = \frac{d_{gap}(t) - d_{gap}(0)}{d_{gap}(0)} \quad (23)$$

609 where the $d_{gap}(t)$ denotes the evolution of layer thickness over time.

610 The temporal evolution of linear chemical shrinkage is presented on the
 611 left in Figure 16. To establish the relationship between curing and chemical
 612 shrinkage, the change in chemical shrinkage with degree of cure, already
 613 calculated in Section 3.2 using Equations 2 and 3, is given on the right side
 614 in Figure 16. The following model equation is proposed to assess the curing-
 615 induced chemical shrinkage:

$$\frac{\Delta L}{L}(q, \theta) = \alpha \left(-\exp\left(\frac{q}{\beta(\theta)}\right) - 1 \right) \quad (24)$$

616 where α is a model parameter and $\beta(\theta)$ is a model function that depends on
 617 the temperature θ at which the experiment is performed.

618 To determine the parameter α and function $\beta(\theta)$ corresponding to 6 dif-
 619 ferent temperatures, the parameters in Equation 24 were identified by the
 620 nonlinear least square method using the `lsqnonlin` function embedded
 621 in Matlab [55]. The prediction results using the identified parameters in
 622 Equation 24 are also depicted in Figure 16 (right). To better address the
 623 experimental results, the following equation is suggested for $\beta(\theta)$:

$$\beta(\theta) = \beta_1 \left(\frac{\theta}{\theta_0} \right)^{\beta_2} \quad (25)$$

624 where β_1 and β_2 are model parameters to be identified and $\theta_0 = 1$ °C is merely
 625 utilized to maintain unit consistency. Table 7 contains a list of the identified
 626 parameters for Equations 24 and 25 (see Appendix E for the details of the
 627 fitting method for $\beta(\theta)$ function).

628 The experimental evolution and estimation of the shrinkage value are
 629 shown in Figure 16. The shrinkage progresses depending on the degree of
 630 cure until the maximum shrinkage at each temperature is reached during
 631 the UV rheometer test. It can be seen that the approximation using this
 632 exponential function can estimate the evolution of the chemical shrinkage as
 633 a function of the degree of cure and temperature. Furthermore, the maximum
 634 shrinkage value was observed at the highest experimental temperature, i.e.
 635 $\theta = 60$ °C, and was found as $(\frac{\Delta L}{L})_{\max} = -0.057$. If the material undergoes
 636 isotropic shrinkage due to UV curing, the chemical shrinkage strain is related
 637 to volumetric shrinkage as follows under the assumption of small strains
 638 [56, 57]:

$$\frac{\Delta L}{L}(q, \theta) = \frac{1}{3} \frac{\Delta V}{V_0}(q, \theta) \quad (26)$$

639 This equation yields the maximum volumetric shrinkage value to $(\frac{\Delta V}{V})_{\max} =$
 640 17.1%. If it is considered that the maximum shrinkage value obtained by
 641 fitting the equation in the previous article [37] is around $(\frac{\Delta V}{V})_{\max} = 16\%$,
 642 it can be concluded that approximately similar results can be obtained for
 643 maximum curing carried out under different conditions with different test
 644 methods. In the previous study, although the sample curing and tests were
 645 performed at room temperature, higher degrees of cure were attained as a
 646 consequence of exposure to more and longer UV light energy. Therefore, it
 647 can be said that it is possible to compare these two results and that these
 648 results are similar.

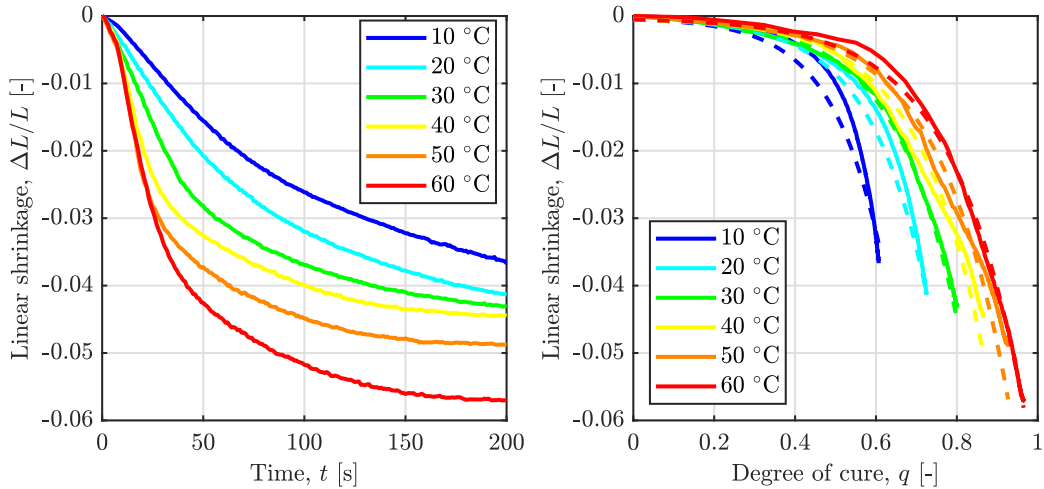

Figure 16: Experimentally measured chemical shrinkage at different isothermal conditions ($\theta = 10, 20, 30, 40, 50, 60$ °C) and constant frequency $f = 1$ Hz using UV rheometer tests. Left: Evolution with the curing time t . Right: Evolution with the degree of cure q and prediction results obtained by Equations 24 and 25.

Table 7: Parameters of the linear shrinkage function defined by Equations 24 and 25.

Parameter	α	β_1	β_2
Value [-]	2.5×10^{-4}	7.8×10^{-2}	2×10^{-1}

649 6. Conclusion and perspectives

650 This work offers a new perspective on the development of a comprehensive
651 thermomechanical model required for the prediction of material properties
652 during and after the photopolymerization reaction by experimental meth-
653 ods. We focus on the effect of the degree of cure, temperature and frequency
654 on the viscoelastic properties and chemical shrinkage of the photopolymer
655 materials. The change of viscoelastic properties and chemical shrinkage due
656 to the UV light induced-crosslinking progress, the conventional rheometer
657 consisting of parallel plates was upgraded with an UV light source and ac-
658 cessories that allow to control the temperature. Thus, time sweeping tests
659 were performed in the controlled isothermal environment and at constant
660 frequencies during the UV irradiation. Unfortunately, improvements are still
661 needed to enhance the quality of the measurements and better integrate them

662 into the material modelling to consider the temperature effect during the UV
663 curing. The measurements, however, revealed the expected qualitative im-
664 provement of viscoelastic properties during constant UV irradiation. During
665 these tests, chemical shrinkage due to isothermal condition and curing has
666 been calculated and a model equation based on these two parameters has
667 been proposed. The time-cure superposition was applied to the UV rheome-
668 ter tests carried out at 20 °C to perform material modelling during curing.
669 DMA measurements of the samples that had been cured beyond the gela-
670 tion point were performed in order to assess and simulate the viscoelastic
671 material properties during the whole curing process. Then, the results from
672 the UV rheometer and DMA were combined and the material modelling was
673 completed during the whole curing.

674 The established modelling framework offers a useful insight to design the
675 photopolymerization-based 3D printed structures, hence improving produc-
676 tion efficiency and final material properties to produce desired parts. As the
677 next stage of this study, the viscoelastic material modelling can be extended
678 by a more generalized time-cure superposition that takes into account the
679 effect of the maximum attainable degree of cure at different temperatures
680 and light intensities during curing, and the effect of glass transition tempera-
681 ture after curing. The future work will involve incorporating those materials
682 modelling into a finite element (FE) simulation methodology, that couples
683 the effects of all pertinent mechanisms, to optimize the 3D printing process.

684 **Acknowledgement**

685 The financial support of the project “Constitutive modelling of UV-curing
686 printed polymer composites” by the Agence nationale de la recherche (ANR)
687 and the German Research Foundation (DFG) under the grant numbers ANR-
688 18-CE92-0002-01 and LI 696/20-1 is gratefully acknowledged.

689 **Conflicts of Interest**

690 The authors declare no conflict of interest.

691 **Appendix A. Modelling of the crosslinking reaction**

692 Tables A.8 and A.9 list the maximum attainable degrees of cure q_{\max} for
 693 all measurements and the identified model parameters, respectively.

Table A.8: Temperature- and UV light intensity-dependent maximum attainable degree of cure $q_{\max}(\mathcal{I}, \theta)$ for all measurements [37].

Temperature ($^{\circ}\text{C}$)	$\mathcal{I} = 5 \text{ mW/cm}^2$	$\mathcal{I} = 10 \text{ mW/cm}^2$
10	0.635	0.742
20	0.757	0.813
30	0.829	0.872
40	0.893	0.918
50	0.951	0.961
60	0.988	0.996

Table A.9: Identified parameters of the model equation for the degree of cure q [37].

Parameter	Value	Unit	Description
A_1	0.135	1/s	Pre-exponential factor of the first Arrhenius coefficient
A_2	0.237	1/s	Pre-exponential factor of the second Arrhenius coefficient
E_1	2003.184	J/mol	Activation energy of the first Arrhenius coefficient
E_2	2005.08	J/mol	Activation energy of the second Arrhenius coefficient
m	1.848	-	Exponent of the first reaction
n	2.2	-	Exponent of the second reaction
b	0.627	-	Scaling factor of the influence of the light intensity
h_{tot}	-404.43	J/g	Total specific heat of reaction

694 **Appendix B. UV rheometry measurements**

695 In Figure B.17, the direct measurement results of the rheometer tests are
 696 given, including the conditioning period without any UV light being applied
 697 for the first 60 seconds.

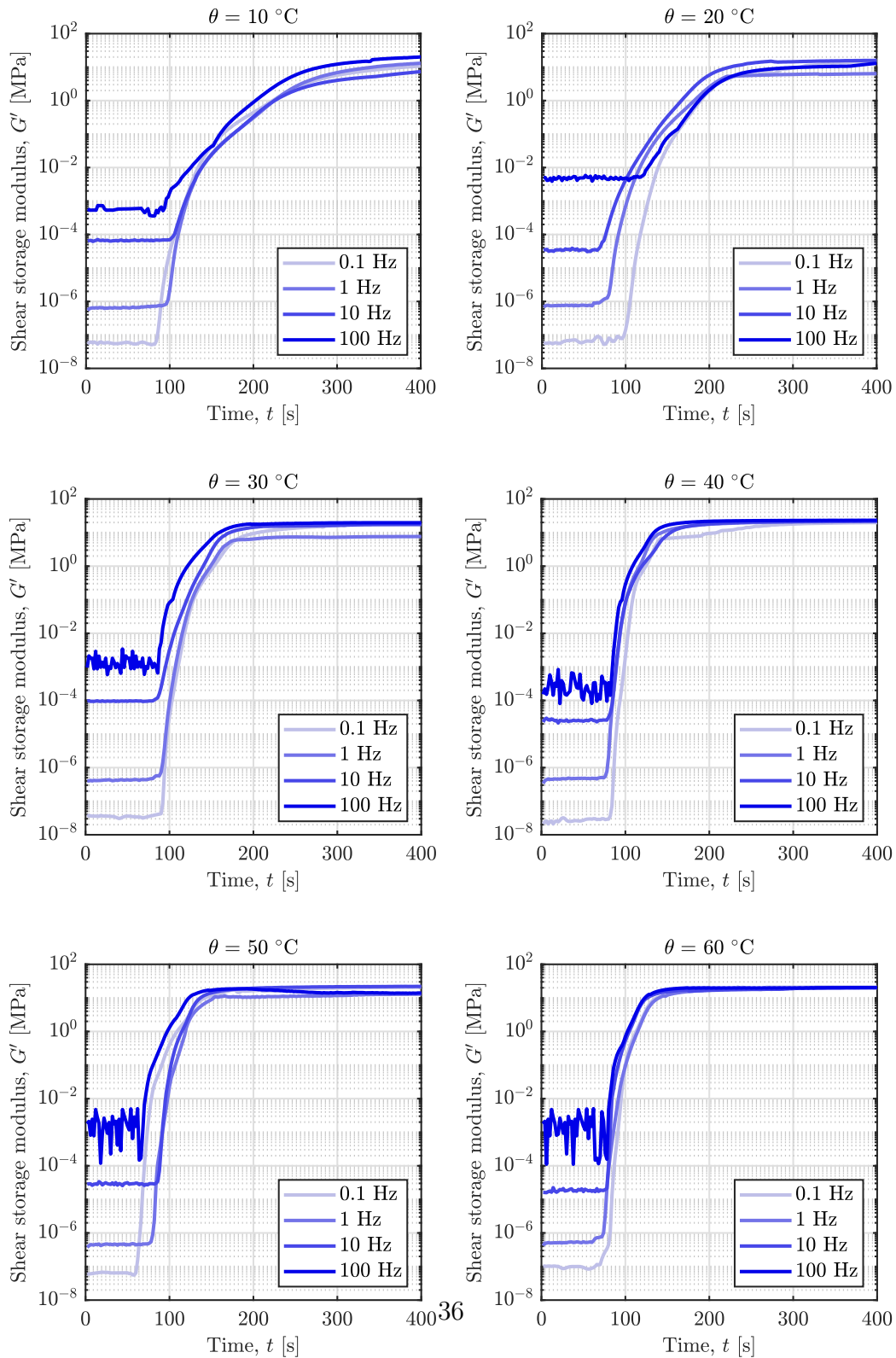

Figure B.17: Evolution of the shear storage modulus G' as a consequence of progressing UV curing in the photopolymer layer at different frequencies and isothermal conditions.

698 **Appendix C. Evolution of the viscoelastic properties after the UV**
699 **curing reaction**

700 *Appendix C.1. DMA measurements: Amplitude sweep tests - damping fac-*
701 *tor*

702 The damping factors measured by DMA for samples at different curing
703 states are presented in Figure C.18. It was observed that the damping factor
704 decreases as the degree of cure increases.

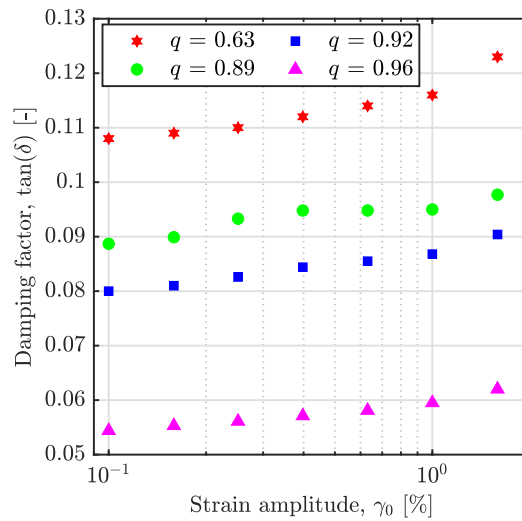

Figure C.18: Damping factors as a function of strain amplitude at $f = 1$ Hz and $\theta = 20$ °C for the samples with different degrees of cure $q = 0.63, 0.89, 0.92, 0.96$.

705 *Appendix C.2. DMA measurements: Frequency sweep tests - shear loss mod-*
706 *uli*

707 The loss moduli results measured by DMA for 4 samples with different
708 degrees of cure are given in Figure C.19. The frequency sweep test at differ-
709 ent isothermal conditions revealed that the loss moduli at low temperatures
710 were almost independent of the degree of cure. For all samples, the loss mod-
711 uli decrease with increasing temperature, and this decrease is greater with
712 decreasing degree of cure.

713 Using these measurements with storage moduli results, the time-temperature
714 superposition was applied and Maxwell elements were identified.

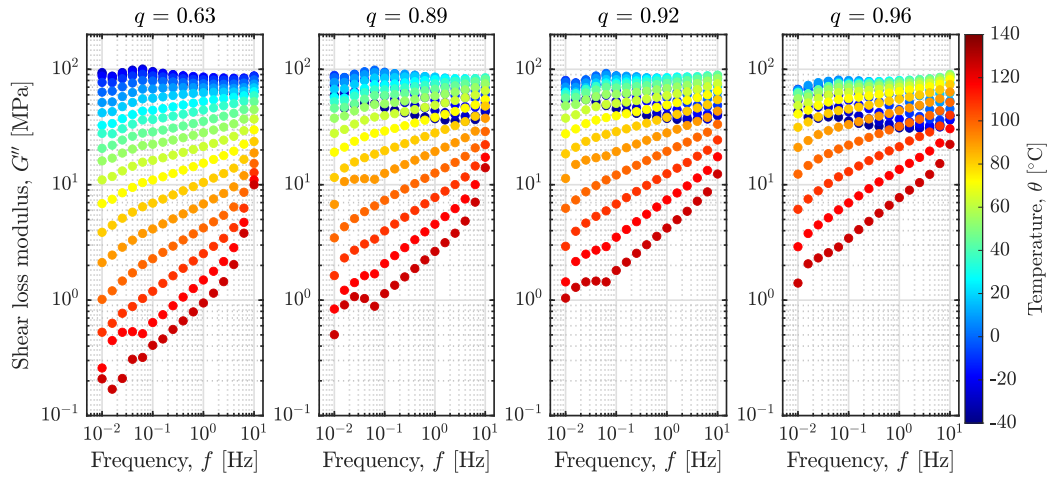

Figure C.19: Isothermal frequency sweep curves of the shear storage modulus G'' obtained from the DMA tests of the samples with different degrees of cure $q = 0.63, 0.89, 0.92, 0.96$.

715 *Appendix C.3. Time-temperature superposition*

716 Figure C.20 shows a comparison of the master curves obtained by shifting
 717 the isothermal curves of samples at different curing states (see Figure 11)
 718 using the TTSP and using the shift factors computed by fitting the WLF
 719 equation given in Equation 16.

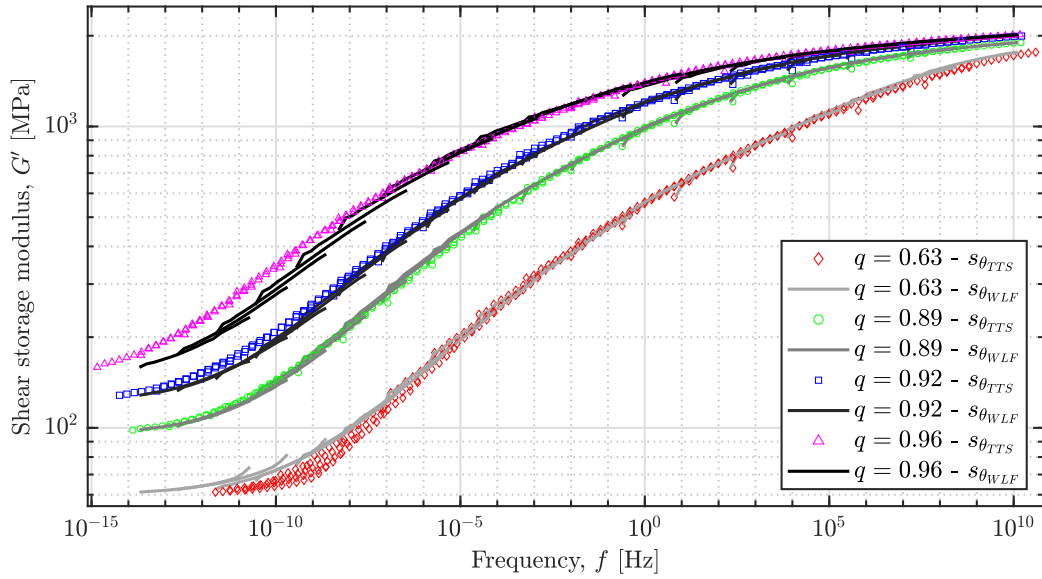

Figure C.20: Comparison of the master curves obtained by shifting the isothermal curves given for different samples in Figure 11 by applying TTSP and using the shift factors calculated by fitting the WLF equation given by Equation 16.

720 *Appendix C.4. Identification of relaxation times and stiffnesses at the ref-*
 721 *erence point*

722 *Appendix C.4.1. Schematic representation of a generalized Maxwell model*

723 Figure C.21 shows a schematic representation of a generalized Maxwell
 724 model with n elements as a part of the rheological network.

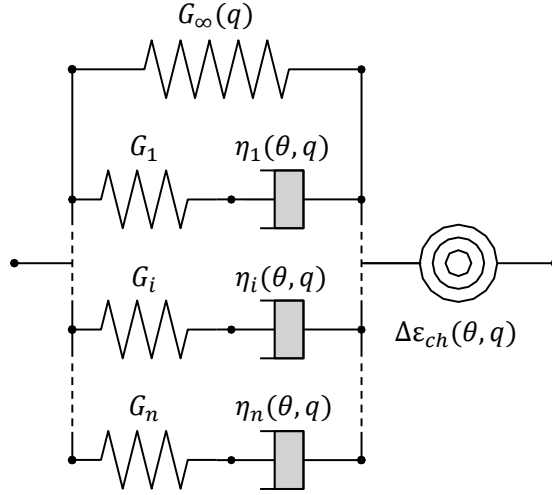

Figure C.21: Rheological network of the proposed model considering the mechanical and chemical deformations of the photopolymers. $\Delta\varepsilon_{ch}(\theta, q)$ represents the degree of cure- and temperature-dependent material parameter for the chemical shrinkage. The left part in which n Maxwell elements are connected in parallel represents degree of cure- and temperature-dependent the generalized Maxwell model considering viscoelastic deformations. A spring assumed independent of degree of cure and temperature spring G_i and a degree of cure- and temperature-dependent dashpot $\eta_i(\theta, q)$ are connected in series for each Maxwell element. An additional spring is connected in parallel to represent the equilibrium modulus $G_\infty(q)$.

725 *Appendix C.4.2. Selection of number of Maxwell elements*

726 Before the identification procedure on the master curve selected as a
 727 reference, the relaxation times must be distributed by selecting a set of n
 728 relaxation times evenly spaced on a logarithmic scale, i.e. $\lambda_{i+1} = a \times \lambda_i$.
 729 The logarithmic step between each relaxation time, denoted by a , can be
 730 calculated from the maximum and minimum relaxation times as follows [58]:

$$a = \left(\frac{\lambda_{\max}}{\lambda_{\min}} \right)^{\frac{1}{n-1}} \quad (\text{C.1})$$

731 if the relaxation times are distributed far apart, this model tends to yield
 732 a loss modulus G'' (or damping factor $\tan(\delta)$) that exhibits oscillations. By
 733 choosing an appropriate a value that gives the best graphic result with the
 734 least possible oscillation and minimal error avoiding overestimation, the re-
 735 laxation times are distributed in a range corresponding to the frequencies
 736 of the master curve for the identification of G_i consistent with the measure-

737 ments.

738 The reference point (i.e. the master curve of the DMA test) for the
739 identification of Maxwell elements was chosen as $q = 0.96$ and $\theta_{ref} = 20$ °C.
740 The following objective function was proposed to determine relaxation times
741 λ_i , stiffnesses G_i and equilibrium modulus G_∞ in the weighted sum method:

$$r = \min_{G_i, G_\infty} \sum_{i=1}^R \left(w_1 \sqrt{\frac{|G'_{exp,i} - G'_{sim,i}|^2}{|G'_{exp,i}|^2}} + w_2 \sqrt{\frac{|G''_{exp,i} - G''_{sim,i}|^2}{|G''_{exp,i}|^2}} \right) \quad (C.2)$$

742 where R is the number of regression points, $G_{exp,i}$ are the experimental shear
743 moduli at regression point i , $G_{sim,i}$ are the simulated shear moduli at regres-
744 sion point i , w_1 and w_2 are weight parameters selected as $w_1 = w_2 = 1$ for
745 all identification procedure. Given that the storage modulus in the measure-
746 ments is about 10 times greater than the loss modulus, this objective function
747 has the advantage that high and low values have same weight on minimiza-
748 tion. Maxwell elements were determined using the nonlinear least square fit of
749 Matlab's [55] built-in routine, `lsqnonlin`, with the Levenberg-Marquardt
750 algorithm, which minimizes the residual r on the proposed objective function
751 given in Equation C.2 by constraining the algorithm as $G_i, G_\infty \geq 0$.

752 To find the optimum number of Maxwell elements, the residual values
753 corresponding to the various a values were examined as in Figure C.22. It
754 has been noticed that using more than 30 Maxwell elements results in overes-
755 timation, the residual value r of the objective function to reach plateau (see
756 Figure C.22), and does not reduce the oscillations in the graphical display.
757 As a result, it was decided to use 30 Maxwell elements in order to minimize
758 the oscillating nature of the shear loss modulus. Figure C.23 compares the
759 measured and simulated shear storage and loss moduli as a consequence of
760 the identification of the viscoelastic spectrum at the reference point. The
761 identified Maxwell parameters are listed in Table C.10. As can be seen,
762 parameters that have been identified provides fitting globally closer to the
763 experimental findings.

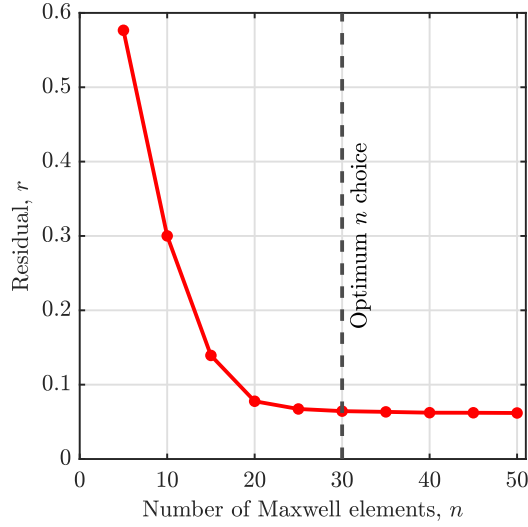

Figure C.22: Change of the residual value of the objective function given in Equation C.2 corresponding to different number of Maxwell elements n , to determine the optimum number of elements that should be selected for the best representation of the long-term viscoelastic material behaviour for $\theta_{ref} = 20$ °C and $q_{ref} = 0.96$ given in Figure C.20.

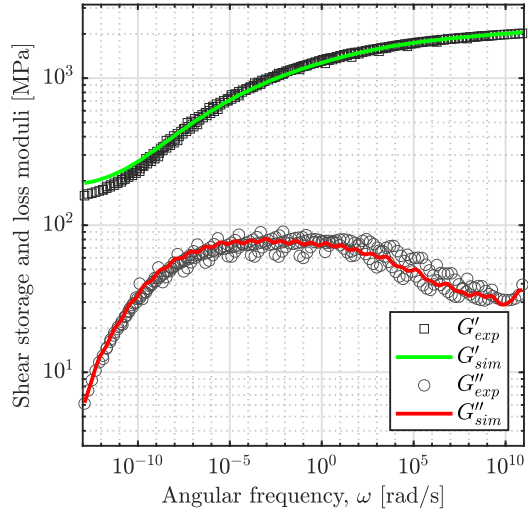

Figure C.23: Simulation of the generalized Maxwell model at the reference point $\theta_{ref} = 20$ °C and $q_{ref} = 0.96$.

764 *Appendix C.4.3. Identified Maxwell parameters*

765 The identified Maxwell parameters are listed in Table C.10.

Table C.10: Identified Maxwell parameters at the reference point $\theta_{ref} = 20^\circ\text{C}$ and $q_{ref} = 0.96$: stiffnesses G_i and relaxation times λ_i^{ref} .

i	Stiffness, G_i [MPa]	Relaxation time, λ_i^{ref} [s]
1	62.619	1.21E-11
2	26.247	8.05E-11
3	41.013	5.33E-10
4	41.009	3.53E-09
5	38.959	2.34E-08
6	50.239	1.55E-07
7	44.231	1.03E-06
8	63.694	6.82E-06
9	56.284	4.52E-05
10	75.671	3.00E-04
11	74.287	1.99E-03
12	81.196	1.32E-02
13	86.886	8.72E-02
14	90.128	5.78E-01
15	88.696	3.83E+00
16	93.597	2.54E+01
17	90.477	1.68E+02
18	98.308	1.11E+03
19	91.596	7.39E+03
20	92.698	4.90E+04
21	91.951	3.25E+05
22	83.760	2.15E+06
23	78.426	1.43E+07
24	70.628	9.45E+07
25	58.337	6.26E+08
26	46.875	4.15E+09
27	33.911	2.75E+10
28	22.485	1.82E+11
29	14.780	1.21E+12
30	6.754	8.01E+12

766 *Appendix C.5. Time-cure superposition*

767 *Appendix C.5.1. Residual analysis*

768 The residual value r increases with decreasing degree of cure, as listed in
 769 Table C.11, compared to the reference result at $q = 0.96$.

Table C.11: Residual values r between experimental master curves and simulation results depending on the degree of cure q calculated by Equation C.2.

Degree of cure, q [-]	Residual values, r [-]
0.63	0.2599
0.89	0.1547
0.92	0.1492
0.96	0.0644

770 *Appendix C.5.2. Degree of cure-dependent equilibrium stiffness*

771 Figure C.24 presents the comparison of experimental and simulated re-
 772 sults for the equilibrium modulus $G_{\infty}(q)$. It should be noted that this model
 773 is valid for degrees of cure above the gelation point tested in DMA.

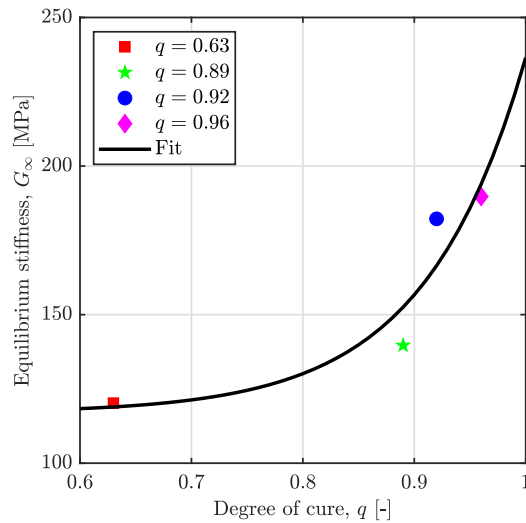

Figure C.24: Degree of cure-dependent equilibrium stiffness $G_{\infty}(q)$ and fitted curve using Equation 21.

774 **Appendix D. Time-cure superposition for the entire curing pro-**
 775 **cess**

776 To combine the shift findings from UV rheometer measurements with
 777 those from DMA measurements, the shift factors up to $q = 0.63$ acquired
 778 as a consequence of the UV rheometer tests at $\theta = 20$ °C given in Figure 7
 779 were vertically and equally shifted downwards by $10^{-8.5}$ to build a continuous

780 curve with the shift factors obtained from the DMA measurements as shown
 781 in Figure D.25.

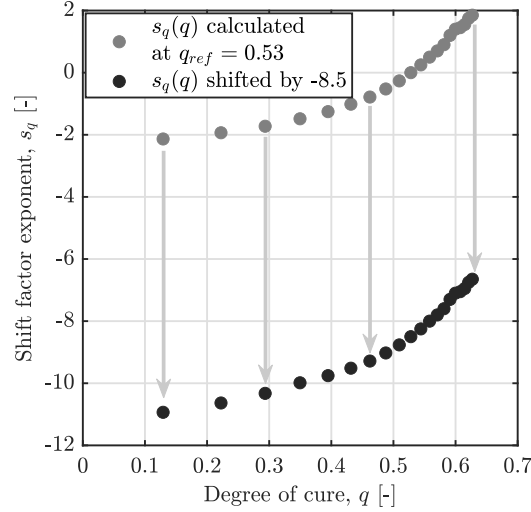

Figure D.25: Equally shifting the shift factor exponents to the base 10 $s_q(q)$ by -8.5 to build continuous $q - s_q$ curve for the time-cure superposition in the entire curing process at $\theta = 20$ °C.

782 Appendix E. Polymerization shrinkage - $\beta(\theta)$ function

783 The natural logarithm of the $\beta(\theta)$ function and temperature values were
 784 taken to establish a relationship between function $\beta(\theta)$ and temperature θ , as
 785 shown in Figure E.26. To better address the experimental results, the follow-
 786 ing equation is suggested as a curve-fitting method for the linear relationship
 787 found in the graph:

$$\beta(\theta) = \beta_1 \left(\frac{\theta}{\theta_0} \right)^{\beta_2} \quad (\text{E.1})$$

788 where β_1 and β_2 are model parameters to be identified and $\theta_0 = 1$ °C is
 789 merely utilized to maintain unit consistency. Table 7 contains a list of the
 790 identified parameters for Equations 24 and E.1.

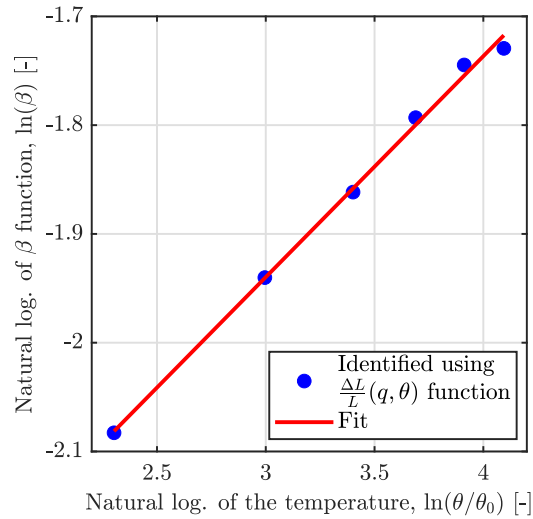

Figure E.26: Curve fitting by the identification of β_1 and β_2 parameters for $\beta(\theta)$ function: To begin with, the natural logarithm of the temperature-dependent results of the $\beta(\theta)$ function obtained from Equation 24 was taken (displayed by blue circles). Then, Equation 25 was fitted to represent the identified results.

791 References

- 792 [1] T. D. Ngo, A. Kashani, G. Imbalzano, K. T. Nguyen, D. Hui, Addi-
793 tive manufacturing (3D printing): A review of materials, methods, ap-
794 plications and challenges, *Composites Part B: Engineering* 143 (2018)
795 172–196.
- 796 [2] A. Al Rashid, W. Ahmed, M. Y. Khalid, M. Koc, Vat photopolymeriza-
797 tion of polymers and polymer composites: Processes and applications,
798 *Additive Manufacturing* 47 (2021) 102279.
- 799 [3] J. Plocher, A. Panesar, Review on design and structural optimisation
800 in additive manufacturing: Towards next-generation lightweight struc-
801 tures, *Materials & Design* 183 (2019) 108164.
- 802 [4] A. Zhakeyev, L. Zhang, J. Xuan, Photoactive resin formulations and
803 composites for optical 3D and 4D printing of functional materials and
804 devices, in: *3D and 4D Printing of Polymer Nanocomposite Materials*,
805 Elsevier, 2020, pp. 387–425.

- 806 [5] N. A. Chartrain, C. B. Williams, A. R. Whittington, A review on fab-
807 ricating tissue scaffolds using vat photopolymerization, *Acta Biomateri-*
808 *alia* 74 (2018) 90–111.
- 809 [6] Q. Mu, L. Wang, C. K. Dunn, X. Kuang, F. Duan, Z. Zhang, H. J.
810 Qi, T. Wang, Digital light processing 3D printing of conductive complex
811 structures, *Additive Manufacturing* 18 (2017) 74–83.
- 812 [7] Z. Ding, C. Yuan, X. Peng, T. Wang, H. J. Qi, M. L. Dunn, Direct 4D
813 printing via active composite materials, *Science Advances* 3 (4) (2017)
814 e1602890.
- 815 [8] L. R. Meza, S. Das, J. R. Greer, Strong, lightweight, and recoverable
816 three-dimensional ceramic nanolattices, *Science* 345 (6202) (2014) 1322–
817 1326.
- 818 [9] M. Layani, X. Wang, S. Magdassi, Novel materials for 3D printing by
819 photopolymerization, *Advanced Materials* 30 (41) (2018) 1706344.
- 820 [10] J. R. Tumbleston, D. Shirvanyants, N. Ermoshkin, R. Januszewicz,
821 A. R. Johnson, D. Kelly, K. Chen, R. Pinschmidt, J. P. Rolland, A. Er-
822 moshkin, et al., Continuous liquid interface production of 3D objects,
823 *Science* 347 (6228) (2015) 1349–1352.
- 824 [11] Y. Shan, A. Krishnakumar, Z. Qin, H. Mao, Reducing lateral stair-
825 stepping defects in liquid crystal display-based vat photopolymeriza-
826 tion by defocusing the image pattern, *Additive Manufacturing* 52 (2022)
827 102653.
- 828 [12] J. G. Leprince, W. M. Palin, M. A. Hadis, J. Devaux, G. Leloup,
829 Progress in dimethacrylate-based dental composite technology and cur-
830 ing efficiency, *Dental Materials* 29 (2) (2013) 139–156.
- 831 [13] J. J. Schwartz, Additive manufacturing: Frameworks for chemical un-
832 derstanding and advancement in vat photopolymerization, *MRS Bulletin*
833 (2022) 1–14.
- 834 [14] C. Decker, The use of UV irradiation in polymerization, *Polymer Inter-*
835 *national* 45 (2) (1998) 133–141.

- 836 [15] G. A. Appuhamillage, N. Chartrain, V. Meenakshisundaram, K. D.
837 Feller, C. B. Williams, T. E. Long, 110th anniversary: Vat
838 photopolymerization-based additive manufacturing: Current trends and
839 future directions in materials design, *Industrial & Engineering Chem-*
840 *istry Research* 58 (33) (2019) 15109–15118.
- 841 [16] D. K. Patel, A. H. Sakhaei, M. Layani, B. Zhang, Q. Ge, S. Magdassi,
842 Highly stretchable and UV curable elastomers for digital light processing
843 based 3D printing, *Advanced Materials* 29 (15) (2017) 1606000.
- 844 [17] H. Cui, R. Hensleigh, D. Yao, D. Maurya, P. Kumar, M. G. Kang,
845 S. Priya, X. R. Zheng, Three-dimensional printing of piezoelectric ma-
846 terials with designed anisotropy and directional response, *Nature Mate-*
847 *rials* 18 (3) (2019) 234–241.
- 848 [18] A. Maurel, A. C. Martinez, S. Grugeon, S. Panier, L. Dupont, P. Cortes,
849 C. G. Sherrard, I. Small, S. T. Sreenivasan, E. MacDonald, Towards high
850 resolution 3D printing of shape-conformable batteries via vat photopoly-
851 merization: review and perspective, *IEEE Access* (2021).
- 852 [19] M. Hossain, P. Steinmann, Degree of cure-dependent modelling for poly-
853 mer curing processes at small-strain. part I: consistent reformulation,
854 *Computational Mechanics* 53 (4) (2014) 777–787.
- 855 [20] D. F. Swinehart, The Beer-Lambert law, *Journal of Chemical Education*
856 39 (7) (1962) 333.
- 857 [21] C. I. Fiedler-Higgins, L. M. Cox, F. W. DelRio, J. P. Killgore, Moni-
858 toring fast, voxel-scale cure kinetics via sample-coupled-resonance pho-
859 torheology, *Small Methods* 3 (2) (2019) 1800275.
- 860 [22] J. Wu, Z. Zhao, C. M. Hamel, X. Mu, X. Kuang, Z. Guo, H. J. Qi, Evo-
861 lution of material properties during free radical photopolymerization,
862 *Journal of the Mechanics and Physics of Solids* 112 (2018) 25–49.
- 863 [23] T. Rehbein, M. Johlitz, A. Lion, K. Sekmen, A. Constantinescu,
864 Temperature- and degree of cure-dependent viscoelastic properties of
865 photopolymer resins used in digital light processing, *Progress in Addi-*
866 *tive Manufacturing* 6 (4) (2021) 743–756.

- 867 [24] J. Zhou, Q.-y. Zhang, S.-j. Chen, H.-p. Zhang, A.-j. Ma, M.-l. Ma,
868 Q. Liu, J.-j. Tan, Influence of thiol and ene functionalities on thiol-
869 ene networks: Photopolymerization, physical, mechanical, and optical
870 properties, *Polymer Testing* 32 (3) (2013) 608–616.
- 871 [25] F. Jiang, A. Wörz, M. Romeis, D. Drummer, Analysis of UV-assisted di-
872 rect ink writing rheological properties and curing degree, *Polymer Test-*
873 *ing* 105 (2022) 107428.
- 874 [26] M. Štaffová, F. Ondreáš, J. Svatík, M. Zbončák, J. Jančář, P. Lepcio, 3D
875 printing and post-curing optimization of photopolymerized structures:
876 Basic concepts and effective tools for improved thermomechanical prop-
877 erties, *Polymer Testing* 108 (2022) 107499.
- 878 [27] S. I. Kundalwal, A. Rathi, Improved mechanical and viscoelastic prop-
879 erties of CNT-composites fabricated using an innovative ultrasonic dual
880 mixing technique, *Journal of the Mechanical Behavior of Materials* 29 (1)
881 (2020) 77–85.
- 882 [28] D. Miedzińska, R. Gieleta, E. Małek, Experimental study of strength
883 properties of SLA resins under low and high strain rates, *Mechanics of*
884 *Materials* 141 (2020) 103245.
- 885 [29] B. J. Green, C. A. Guymon, Modification of mechanical properties and
886 resolution of printed stereolithographic objects through raft agent incor-
887 poration, *Additive Manufacturing* 27 (2019) 20–31.
- 888 [30] E. A. Garcia, A. J. Qureshi, C. Ayranci, A study on material-process in-
889 teraction and optimization for vat-photopolymerization processes, *Rapid*
890 *Prototyping Journal* (2018).
- 891 [31] K. G. Mostafa, M. Arshad, A. Ullah, D. S. Nobes, A. J. Qureshi, Con-
892 current modelling and experimental investigation of material properties
893 and geometries produced by projection microstereolithography, *Poly-*
894 *mers* 12 (3) (2020) 506.
- 895 [32] H. Gojzewski, Z. Guo, W. Grzelachowska, M. Ridwan, M. Hempenius,
896 D. Grijpma, G. Vancso, Layer-by-layer printing of photopolymers in 3D:
897 How weak is the interface?, *ACS applied materials & interfaces* 12 (7)
898 (2020) 8908–8914.

- 899 [33] M. Lebedevaite, J. Ostrauskaite, E. Skliutas, M. Malinauskas,
900 Photocross-linked polymers based on plant-derived monomers for po-
901 tential application in optical 3D printing, *Journal of Applied Polymer*
902 *Science* 137 (20) (2020) 48708.
- 903 [34] D. A. Rau, J. P. Reynolds, J. S. Bryant, M. J. Bortner, C. B. Williams,
904 A rheological approach for measuring cure depth of filled and unfilled
905 photopolymers at additive manufacturing relevant length scales, *Addi-*
906 *tive Manufacturing* 60 (2022) 103207.
- 907 [35] Arkema N3xtDimension[®]- PR48 - Clear Prototyping Material: Tech-
908 nical Data Sheet, Available at [https://cpspolymers.com/PR48%](https://cpspolymers.com/PR48%20TDS.pdf)
909 [20TDS.pdf](https://cpspolymers.com/PR48%20TDS.pdf), accessed: 10/09/2022.
- 910 [36] EMBER[™]- PR48 - Autodesk Standard Clear Prototyping Resin
911 (PR48), Available at [https://cdn2.hubspot.net/hubfs/](https://cdn2.hubspot.net/hubfs/1545937/Autodesk_Standard_Clear_PR48_Formulation.pdf?__hss)
912 [1545937/Autodesk_Standard_Clear_PR48_Formulation.](https://cdn2.hubspot.net/hubfs/1545937/Autodesk_Standard_Clear_PR48_Formulation.pdf?__hss)
913 [pdf?__hss](https://cdn2.hubspot.net/hubfs/1545937/Autodesk_Standard_Clear_PR48_Formulation.pdf?__hss), accessed: 10/09/2022.
- 914 [37] K. Sekmen, T. Rehbein, M. Johlitz, A. Lion, A. Constantinescu,
915 Thermal analysis and shrinkage characterization of the photopolymers
916 for DLP additive manufacturing processes, *Continuum Mechanics and*
917 *Thermodynamics* (2022) 1–18.
- 918 [38] K. Sekmen, T. Rehbein, M. Johlitz, A. Lion, A. Constantinescu, Ma-
919 terial modelling of the photopolymers for additive manufacturing pro-
920 cesses, in: *2022 International Solid Freeform Fabrication Symposium*,
921 *University of Texas at Austin, 2022*, pp. 94–106.
- 922 [39] T. Rehbein, A. Lion, M. Johlitz, A. Constantinescu, Experimental in-
923 vestigation and modelling of the curing behaviour of photopolymers,
924 *Polymer Testing* 83 (2020) 106356.
- 925 [40] J. D. Ferry, *Viscoelastic properties of polymers*, 3rd Edition, John Wiley
926 & Sons, 1980.
- 927 [41] ISO 6721-2 - *Plastics — Determination of dynamic mechanical proper-*
928 *ties — Part 2: Torsion-pendulum method*, , International Organization
929 for Standardization, Geneva, CH (2019).

- 930 [42] M. Di Francescantonio, T. R. Aguiar, C. A. G. Arrais, A. N. Cavalcanti,
931 C. U. Davanzo, M. Giannini, Influence of viscosity and curing mode on
932 degree of conversion of dual-cured resin cements, *European Journal of*
933 *Dentistry* 7 (1) (2013) 81.
- 934 [43] H. H. Winter, F. Chambon, Analysis of linear viscoelasticity of a
935 crosslinking polymer at the gel point, *Journal of Rheology* 30 (2) (1986)
936 367–382.
- 937 [44] ASTM D4473 - 08 - Standard Test Method for Plastics: Dynamic Me-
938 chanical Properties: Cure Behavior, Standard, ASTM International,
939 West Conshohocken, PA, USA (2008).
- 940 [45] J. Lange, J.-A. E. Månson, A. Hult, Build-up of structure and viscoelas-
941 tic properties in epoxy and acrylate resins cured below their ultimate
942 glass transition temperature, *Polymer* 37 (26) (1996) 5859–5868.
- 943 [46] P. F. Jacobs, *Rapid prototyping & manufacturing: fundamentals of*
944 *stereolithography*, Society of Manufacturing Engineers, 1992.
- 945 [47] D. Adolf, J. E. Martin, Time-cure superposition during crosslinking,
946 *Macromolecules* 23 (15) (1990) 3700–3704.
- 947 [48] Y. Eom, L. Boogh, V. Michaud, P. Sunderland, J.-A. Månson, Time-
948 cure-temperature superposition for the prediction of instantaneous vis-
949 coelastic properties during cure, *Polymer Engineering & Science* 40 (6)
950 (2000) 1281–1292.
- 951 [49] ASTM D7175 - 08 - Standard Test Method for Determining the Rheo-
952 logical Properties of Asphalt Binder Using a Dynamic Shear Rheometer,
953 Standard, ASTM International, West Conshohocken, PA, USA (2008).
- 954 [50] DIN 51810-2 - Testing of lubricants - Testing rheological properties of
955 lubricating greases - Part 2: Determination of flow point using an os-
956 cillatory rheometer with a parallel-plate measuring system, Standard,
957 Deutsches Institut für Normung e.V, Berlin, DE (2017).
- 958 [51] P. Butaud, V. Placet, J. Klesa, M. Ouisse, E. Foltete, X. Gabrion, In-
959 vestigations on the frequency and temperature effects on mechanical
960 properties of a shape memory polymer (Veriflex), *Mechanics of Materi-
961 als* 87 (2015) 50–60.

- 962 [52] Z. Zhao, J. Wu, X. Mu, H. Chen, H. J. Qi, D. Fang, Desolvation induced
963 origami of photocurable polymers by digit light processing, *Macromolecu-*
964 *lar Rapid Communications* 38 (13) (2017) 1600625.
- 965 [53] C. Gorsche, R. Harikrishna, S. Baudis, P. Knaack, B. Husar, J. Laeuger,
966 H. Hoffmann, R. Liska, Real time-NIR/MIR-photorheology: a versatile
967 tool for the in situ characterization of photopolymerization reactions,
968 *Analytical Chemistry* 89 (9) (2017) 4958–4968.
- 969 [54] G. Sun, X. Wu, R. Liu, A comprehensive investigation of acrylates pho-
970 topolymerization shrinkage stress from micro and macro perspectives by
971 real time MIR-photo-rheology, *Progress in Organic Coatings* 155 (2021)
972 106229.
- 973 [55] Matlab online documentation, Available at [https://www.](https://www.mathworks.com/help/)
974 [mathworks.com/help/](https://www.mathworks.com/help/), accessed: 01/10/2022.
- 975 [56] T. Wu, Theoretical modeling and experimental characterization of stress
976 and crack development in parts manufactured through large area mask-
977 less photopolymerization, Ph.D. thesis, Georgia Institute of Technology
978 (2014).
- 979 [57] B. Fayolle, L. Audouin, G. George, J. Verdu, Macroscopic heterogeneity
980 in stabilized polypropylene thermal oxidation, *Polymer Degradation and*
981 *Stability* 77 (3) (2002) 515–522.
- 982 [58] A. Jouan, Influence du vieillissement en atmosphère confinée sur la pré-
983 diction de la durée de vie des joints adhésifs, Ph.D. thesis, Université
984 Paris-Saclay (ComUE) (2018).