



HAL
open science

Towards a link mapping and evaluation approach for Core Operational Business-IT Alignment

Ali Benjilany, Pascal André, Dalila Tamzalit, Hugo Bruneliere

► To cite this version:

Ali Benjilany, Pascal André, Dalila Tamzalit, Hugo Bruneliere. Towards a link mapping and evaluation approach for Core Operational Business-IT Alignment. 26th International Conference on Enterprise Information Systems (ICEIS 2024), Apr 2024, Angers, France. hal-04447879

HAL Id: hal-04447879



<https://hal.science/hal-04447879>

Submitted on 16 Feb 2024

HAL is a multi-disciplinary open access archive for the deposit and dissemination of scientific research documents, whether they are published or not. The documents may come from teaching and research institutions in France or abroad, or from public or private research centers.

L'archive ouverte pluridisciplinaire **HAL**, est destinée au dépôt et à la diffusion de documents scientifiques de niveau recherche, publiés ou non, émanant des établissements d'enseignement et de recherche français ou étrangers, des laboratoires publics ou privés.

Towards a link mapping and evaluation approach for Core Operational Business-IT Alignment

Ali Benjilany¹, Pascal André¹ ^a, Dalila Tamzalit² ^b, and Hugo Bruneliere³ ^c

¹Nantes Université, LS2N - CNRS, Nantes, France

²IMT Atlantique, LS2N - CNRS, Nantes, France

{Firstname.Lastname}@univ-nantes.fr; hugo.bruneliere@imt-atlantique.fr

Keywords: Information Systems - Enterprise Architecture - Core Operational Business-IT Alignment - Business Process modelling - Software Application modelling.

Abstract: Business-IT Alignment (BITA) is an important mean of evaluating the performance of IT systems operating within a business organisation. The software architects' need for representing, analysing and interpreting the alignment situations remains among the main challenges. Despite different initiatives in the last two decades, available solutions remain too diverse and limited. As a consequence, more methodological guidelines are still needed to improve the support for BITA. In this paper, we address Core Operational BITA (COBITA) as a subset of BITA which targets the operational integration of business and application artefacts. To this end, we first propose two types of COBITA links between the business layer and the application one. We propose then an approach for establishing these links and evaluating them. The objective is to provide indicators for domain experts and software architects to assess the quality of the alignment between the two layers. We decided to choose Archimate, a standard language, to model the business and application layers. Then, we specify the two types of COBITA links to establish a mapping between the business and applications layers. Finally, we rely on the obtained cartography to evaluate the alignment via a set of proposed metrics and consistency rules. An initial version of the approach has been implemented in the Archi tool, and we experimented with it on the SoftSlate system.

1 INTRODUCTION

A main concern of Information System (IS) architects is to design efficient IT solutions that match with the business activities of their organisations. In this context, Business-IT Alignment (BITA) is a mean to measure and evaluate the consistency between these two points of view. In the literature, the term *alignment* refers to both the process of establishing links and the result of this process. When the alignment is not correct, it generally refers to quality issues related to integration (e.g., Business-IT gap, alignment problem (Kassahun and Tekinerdogan, 2020), misalignment (Gouigoux and Tamzalit, 2021)).

Strategic Alignment Model (SAM) (Henderson and Venkatraman, 1999) is a reference model for BITA. It separates the strategic and operational levels for both the business and IT points of view, but

remains too informal to be applied in practice. Enterprise Architecture (EA) (Lankhorst, 2013) provides a more convenient framework. It covers many stakeholder's points of view, from business strategy to IT infrastructure. In EA, alignment is about connecting layers via concepts of their underlying models. A later work (Habba et al., 2019) narrowed the scope to *Operational BITA*, i.e., the alignment of business requirements with business processes and software systems. This definition is interesting to compare existing approaches. However, mixing requirements with processes in business models can be confusing and no supporting framework has been provided up to know. Very recently, the scope has been narrowed down to *Core Operational Business-IT Alignment (COBITA)* as the operational integration of the business and application layers (André et al., 2023). This is the actual *core* area where the business view meets the IT view.

COBITA is a preoccupation for IS architects (e.g., Enterprise Architects, Solution Architects, Technical Architects). In practice, they use modelling and documentation to analyse the alignment and recommend

^a  <https://orcid.org/0000-0002-1112-2973>

^b  <https://orcid.org/0000-0002-0985-0226>

^c  <https://orcid.org/0000-0002-5987-2175>

evolution scenarii. However, the existing BITA surveys (Zhang et al., 2018; Habba et al., 2019; Gellweiler, 2021; André et al., 2023) mention the lack of methodological and tooling support to assist the architects in feeding the models, discovering the alignment links, evaluating the obtained cartography, proposing evolution scenarii and, ideally, realizing the alignment. Moreover, the whole process should be applied iteratively. Thus, in the COBITA context, several research questions have to be explored (André et al., 2023). They concern (i) the impact of how the business and application layers are modelled; (ii) the variety of the stakeholder’s concerns, called *dimensions*; (iii) the tool support to perform the COBITA continuous process and (iv) case studies or benchmarks to compare existing approaches.

The work in this paper is a first step towards addressing these research questions. In particular, we cover the following COBITA steps: (1) Identify the concepts to be considered from the two layers; (2) Specify different types of links between these concepts, considering various dimensions; (3) Establish concrete links between elements from the two layers to obtain a cartography; (4) Evaluate this cartography by applying various metrics and/or consistency rules; (5) Contribute to the tool support by partially automating this evaluation process; (6) Propose an open case study for experimenting with our approach.

The remainder of this paper is organised as follows. Section 2 introduces the background on which we build our approach. Section 3 describes the concepts of the business and application layers we consider. Section 4 proposes two new types of COBITA links, illustrated on simple examples. Section 5 provides a first set of metrics and consistency rules to evaluate the alignment. Section 6 presents the current tool support coming with our approach. Section 7 illustrates the practical application of our approach on a case study. Section 8 discusses the related work, before Section 9 concludes and opens on future work.

2 BACKGROUND

As introduced in Section 1, BITA is about evaluating how IT systems fit with enterprise business activities. COBITA reduces the scope to aligning the business layer (mostly the business processes organising the enterprise activities) and the application layer (an architectural view of the IT systems).

As shown in Figure 1, we consider two layers, namely *business* and *application*, represented by two distinct models. The geometric figures represent model elements which are instances of different **con-**

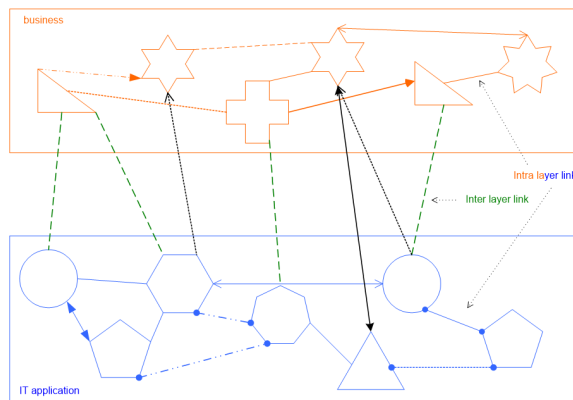

Figure 1: COBITA links schematisation

cepts at the business process-level (activities, events, actors, business objects, etc.) and application-level (components, libraries, services, tasks, data object, etc.). These elements are connected by **links**¹ inside a given layer (**intra-layer links**) or between layers (**inter-layer links**). Intra-layer links are, for instance, data flow, control flow in the business layer or association, inheritance in the application layer. Inter-layer links represents correspondence, traceability, refinement or dependency between concepts of the two layers. In our work, a set of inter-layer links is called a **mapping**.

A **dimension** is a point of view on the alignment. In Figure 1, two dimensions are represented, denoted by the dashed lines and the filled arrows. Such dimensions target the possible concerns of the different stakeholders, *e.g.* functions, data, security or privacy. For example, in IS modelling, we usually make a distinction between the structure, the functional behavior and the dynamic behaviour (cf. the Function-Behaviour-Structure Ontology (Gero and Kannengiesser, 2014)).

In the remainder of the paper, we focus on **two dimensions (functions and data)**; these two are the most commonly studied dimensions in COBITA works (André et al., 2023). It is important to note that the inter-layer links belong to the model of the business and application layers (cf. Section 3) while the inter-layer links are defined by the enterprise architect when establishing the cartography (Section 4). Both types of links can be considered when evaluating the COBITA especially when detecting patterns or applying consistency rules (cf. Section 5). According to our survey (André et al., 2023), performing COBITA evaluation includes (i) checking consis-

¹In the ISO 42010 standard (ISO/IEC/IEEE, 2011), a link, called a *correspondence*, defines a relation between model elements called *architecture description elements*, and can be governed by *correspondence rules*.

tency and completeness of the alignment, (ii) calculating metrics and rates to evaluate the alignment, (iii) analysing change impact for maintenance and evolution, (iv) computing coverage for different dimension. In this paper, we consider the two first items. To this end, we propose first metrics related to the implementation of business and application functions (cf. Section 5.1). We also provide a couple of consistency rules in order to evaluate the structure of the established COBITA cartography (cf. Section 5.2).

3 MODELLING LAYERS

In order to be able to detect an alignment state, we first need to have a representation of the concepts of each layer, and thus the layers themselves. Having a representation allows to handle them in terms of modelling and evaluation. The main standards modelling languages are UML and BPMN 2.0 but, in this work, we chose to rely on **Archimate** because (i) it includes the concept of layers and aspects to structure the models; (ii) it is generic enough to serve as a pivot language for future interoperability with other languages; (iii) it offers several links between concepts. Archimate also comes with a reference tool support (cf. Section 6). Finally Archimate is quite compatible with BPMN or UML up to some abstraction and model transformation.

We selected Archimate concepts that are representative for COBITA, and we show them in Table 1. We considered the two usual dimensions that can be found in the literature (Habba et al., 2019; André et al., 2023), namely functional and data. The former refers to functionalities that implement business activities or IT processes, it belongs to the *behavior* in Archimate. The latter refers to the data and information existing in any IS, it belongs to the *passive structure* in Archimate. The business layer models are represented using yellow diagrams in Archimate, while the application layer models are represented using blue diagrams.

		Dimensions		
		Functional	Data	
concepts	business layer	B-funct	B-Data	...
		Business processes	Business objects	
		Business functions	Contracts	
	application layer	A-funct	A-Data	
		Application functions	Data object	
		Services	Data relation	

Table 1: Selected Archimate concepts for COBITA

In Table 1, we mention only the main concepts that are involved in inter-layer links for the functional and data dimensions. In the next section, we define the inter-layer links and bind them to the dimensions.

4 DEFINING INTER-LAYER LINKS

In Section 2, we introduced the notions of *inter-layer link*, *dimension* and *mapping*. We define two types of inter-layer links between the concepts of Table 1: *implementation links* (related to the functional dimension) and *representation links* (related to the data dimension). These two links are generic and independent from any modelling language (BPMN, UML, Archimate). In the illustrating figures, it is implemented by stereotypes of the *Association*, a dependency relationship of Archimate. We did not use the *Serving* and *Realization* relationships because they are too specific to functions and processes.

Definition 1 (Implementation link). *An implementation link expresses that a concept of the Business layer in the functional dimension is implemented by a concept of the Application layer in the functional dimension. It means that a **A-funct** concept is part of the implementation of the behaviour of a **B-funct** concept.*

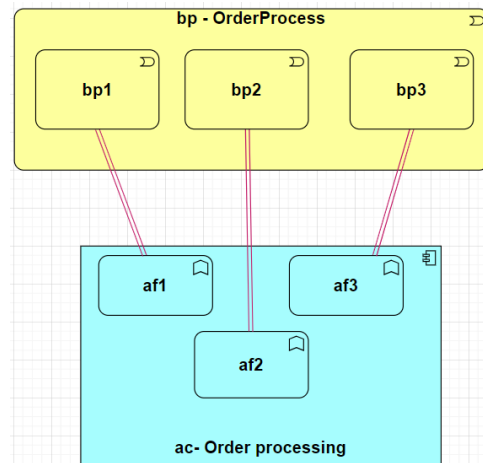

Figure 2: Illustration of implementation links

Implementation links are illustrated in Figure 2: a business process **bp-orderProcess** is composed of three business processes: **bp1**, **bp2**, **bp3**. Each of them is **implemented** by one application function (respectively **af1**, **af2**, **af3**).

Definition 2 (Representation link). *A representation link expresses that a concept of the business layer in the data dimension (e.g. a **B-data** business object) is*

represented by a concept of the application layer in the data dimension (e.g. a **A-data Object**).

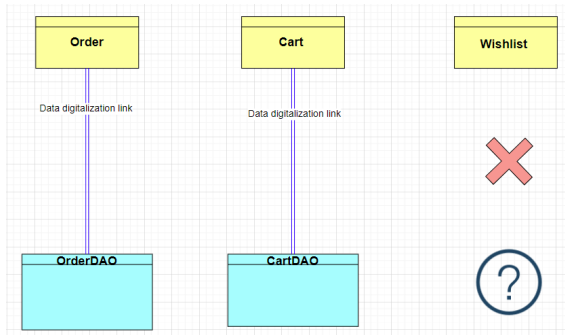

Figure 3: Illustration of representation links

Representation links are illustrated in Figure 3, where two *Business objects*, **Order** and **Cart** are represented by the *Data Objects* **OrderDAO** and **CartDAO** respectively. However, **Wishlist** is not represented by any A-data concept.

We define a **cartography** as a collection of mappings that connect the business and application layers. Each mapping is associated to one dimension. Having several dimensions enables a customised evaluation of the alignment. We address the actual evaluation process in the next section.

5 EVALUATING THE ALIGNMENT

The evaluation of COBITA relies on the knowledge of domain experts and architects. As mentioned at the end of Section 2, we opted for a combination of metrics and consistency rules. Indeed, they can be automated which is a main request from enterprise architects. In what follows, we define different metrics to quantify alignment and a couple of logical rules to evaluate the consistency on both the functional and data dimensions. These are based on the implementation and representation links defined in Section 4.

5.1 Evaluation based on metrics

The set of metrics we defined includes 1. the degree of coverage of business concepts by application concepts, 2. the level of implementation of business concepts, and 3. the level of application concepts implementing business concepts. These metrics are inspired from (Cavano and McCall, 1978) as a main reference for software quality measurements, and (Etien and Rolland, 2005) as a main reference for relationship fitness measurement in BITA. For each metric,

we provide both the computation logic and the result interpretation.

Metric 1 : Number of implementation links of a given Business functional concept. The objective is to calculate the number of implementation links, $M1$, in which a Business functional concept participates in. Three cases requires attention:

1. $M1 = 0$: The business functional concept is not implemented. This value is a warning indicator for domain experts and software architects who have to decide whether this is not worrying or it is actually a misalignment situation.
2. $M1 = 1$: The business functional concept is implemented once which is the ideal alignment situation. However, one cannot ensure that it is correctly implemented.
3. $M1 > 1$: The business functional concept is implemented more than once. This is generally an indicator of bad alignment that the domain experts and software architects should consider. It is up to them to decide whether the situation is problematic or not. Such situation is not a problem if this choice has been done on purpose. In fact, in some cases, refining the implementation of a business functional concept by multiple application functions is required. However, we consider that the higher the number of implementation links is, the bigger is the risk of misalignment, as it represents a "multiple functional implementation" anti-pattern (Gouigoux and Tamzalit, 2021).

Metric 1 reveals situations of misalignment related to the implementation of one specific business functional concept. The next metrics exploits this metric to evaluate the implementation state by considering all the business functional concepts.

Metric 2 : Rate of unimplemented business functional concepts. Applying **Metric 1** on all business functional concepts allows to identify and calculate the number of all unimplemented ones. Given the total number of business functional concepts, we can calculate **Metric 2** by *Rate of unimplemented B-funct concepts = Number of unimplemented B-funct concepts / Total number of B-funct concepts*. The result of **Metric 2** is an indicator for the software architects. For instance, along with business domain experts and IT developers, they can set a threshold from which the rate of unimplemented B-funct concepts becomes a warning. Such threshold can be a contract between business and IT representatives, while the architect plays the role of mediator.

Metric 3: Most implemented business functional concepts. Relying on Metric 1, it is possible to sort out the B-funct concepts from the most to the less implemented. This would allow the architect to have a clear overview on the most demanding B-funct concepts in terms of implementation. Therefore, such information would allow to target more easily the B-funct concepts to keep under control.

Metric 4. Number of implementation links of an application functional concept. While Metrics 1-2-3 focus on the links where B-funct concepts are involved, Metric 4 focus on the links where application functional concepts are involved. The objective is to calculate M4, the number of B-funct concepts implemented by one A-funct concept. Three cases requires attention:

1. $M4 = 0$: If an application functional concept *A-funct* does not have any related implementation link, it means that this A-funct concept is not implementing any B-funct concept, at least directly. In fact, sometimes, an A-funct concept is called by another A-funct concept which is itself implementing a B-funct concept. However, this situation can produce inconsistencies, leading to the *Pure technical integration* BITA Antipattern (Gouigoux and Tamzalit, 2021).
2. $M4 = 1$: The A-funct concept implements one Bus-Func concept, which is the ideal alignment situation. However, this cannot ensure the quality of the implementation.
3. $M4 > 1$: an A-funct concept implementing more than one B-func concepts should be alerting. Such a situation can occur in the context of legacy monolith applications. It is a *Monolith application* BITA anti-pattern (Gouigoux and Tamzalit, 2021).

Globally, the results of Metric 4 are useful to reveal situations of misalignment related to the number of implementations provided by a A-funct concept for B-funct concept(s). The next step is to exploit this metric to evaluate the implementation state by considering all the A-funct concepts.

Metric 5. Rate of application functions concepts not implementing business function concepts. By grouping the Metric 4 *M4* results applied on all application function concepts, *A-func* concepts, we can calculate the number of all *A-func* concepts that do not implement *B-func* concepts. In addition, given the total number of *A-func* concepts, we can calculate the resulting Metric 5 by *Rate of A-func concepts that are not implementing B-func concepts = number*

of A-func concepts that are not implementing A-func concepts / total number of A-func concepts. This metric gives a general overview of the degree of A-func concepts involved in the alignment mapping. For instance, let us suppose that more than half A-func concepts are not implementing at least one B-func concepts, this would be a questionable situation to deal with. Several reasons can cause such situation. It can be symptomatic of accumulated dead code (e.g., due to poor architecture decisions). It can be simply due to code that does not conform to the designed architecture. It can also be caused by an evolution in the organization related to legacy software.

Metric 6. Application function concepts most implementing business function concepts. Based on the results of Metric 4, we can also identify the **A-func concepts most implementing B-func concepts**. This metric can be an indicator about the global application functions concepts organisation and usage. For instance, having an A-func concept that implements the third of existing B-func concepts while some others are not (directly) implementing any B-func concept might reveal a questionable imbalance load of A-func concepts.

We proposed two metrics to calculate the number of implementation and representation links, two metrics to calculate rates of implemented versus non-implemented B-func concepts and A-func concepts implementing versus non-implementing B-func concepts, and, finally, two metrics to calculate the most implemented B-func concepts and the most A-func implementing B-func concepts. These metrics represent a first evaluation means of the cartography of links between the business and application layers and following the two functional and data dimensions. We present now a second means of evaluation.

5.2 Evaluation of alignment consistency

While metrics evaluate quantitatively alignment, consistency belongs the qualitative evaluation. We define here some of the logical rules that enable to verify the consistency involving different concepts of the two dimensions. Compared to evaluation based on metrics, which is more quantitative, evaluation based on consistency rules is more structural. Thus, we try to identify patterns of links composed of 1) **inter-layer** links between concepts of a same dimension (but different layers) and 2) **intra-layer** links between concepts of a same layer (but different dimensions).

Consider the following sets BfC =B-func concepts, BdC =B-data concepts, AfC =A-function concepts and AdC =A-data concepts. Let $(bfc, bfd) \in BfC \times BdC$ and $(afc, adc) \in AfC \times AdC$. Let us consider the fol-

lowing propositions:

- A : bfc accesses bdc
- B : afc accesses adc
- C : bfc is implemented by afc
- D : bdc represented by adc

We propose the following consistency rules :

$$(A \wedge B) \wedge C \implies D \quad (1)$$

$$(A \wedge B) \wedge D \implies C \quad (2)$$

(1) We verify for each pair (bfc, bdc) where bfc accesses bdc . If there is an afc implementing bfc then adc , that is accessed by afc , should represent bdc . For instance, in Figure 4, the pair of (bfc, bdc) (*Create a test customer account*, *Customer*) shows that *Create a test customer account* accesses *Customer*. There is also the afc *Register* that implements the bfc *Create a test customer account*. The consistency rule will be at true if the adc *CustomerDAO* represents the bdc *Customer*. It will be at false if it is not the case, as illustrated in Figure 5.

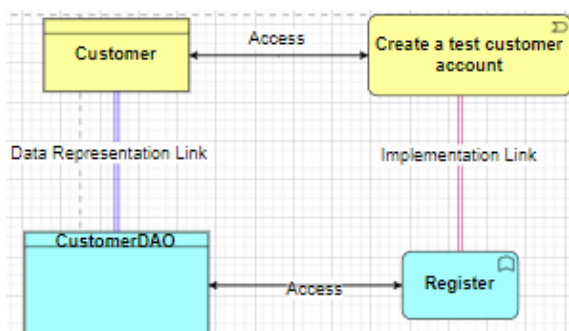

Figure 4: Rules for consistency verification

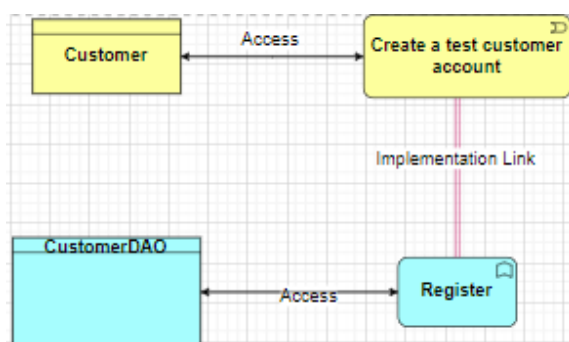

Figure 5: Non-verified Rule 1

(2) We verify for each pair (bfc, bdc) where bfc accesses bdc . If there is an adc representing bdc then afc that accesses adc , should implement bfc . For instance, in Figure 4, the pair of (bfc, bdc) (*Create a test customer account*, *Customer*) shows that *Create a test*

customer account accesses *Customer*. There is also the adc *CustomerDAO* that represents the bdc *Customer*. The consistency rule will be at true if the afc *Register* implements the bfc *Create a test customer account*. It will be at false if it is not the case, as illustrated in Figure 6.

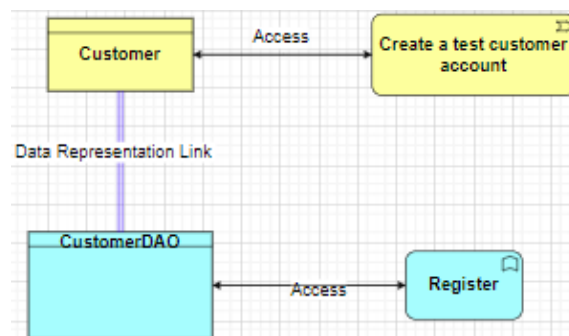

Figure 6: Non-verified Rule 2

We proposed two means to evaluate the alignment between the two layers and according to the two dimensions: six metrics on pairs of concepts of Business and Application layers and two consistency rules. These two means provide indicators to domain experts and software architects about the current state of the alignment of their systems. In the next section, we propose tool support for them.

6 IMPLEMENTATION

Establishing the links and evaluating the alignment are complex and tedious activities, especially for large information systems frequently evolving over time. Indeed the COBITA activity replays periodically. To be applicable, the evaluation means of Section 5 must be implemented and supported by a tool for enterprise Architects. There is a stack of requirements to fulfill: (1) layer models, (2) link cartography, (3) metrics and rule statements.

There exist various EA tools such as Visual-Paradigm, SmartEA, Enterprise Architect or Modelio BA. To implement the tool support associated to our proposed approach, we decided to rely on the open source Archimate modelling tool named Archi² for different reasons: (i) Archi is an Enterprise Architecture solution fully implementing the Archimate standard language that allows to properly model the two layers and related concepts we target in the context of COBITA (cf. Section 3); (ii) Archi is an open source solution that can be freely reused and/or refined according to our needs, for instance to repre-

²<https://www.archimatetool.com/>

sent and handle the COBITA links as extensions of standard Archimate links (cf. Section 4); (iii) Archi comes with an ecosystem and community offering several additional plugins, including notably jArchi³ that allows to navigate and query Archimate models for evaluating the alignment (cf. Section 5).

The current version of the provided tool support is structured as follows:

- **Base Archi** for modelling the business and application layers. For layers modelling, we directly rely on the Archimate modelling features provided by the Archi tool. This includes a graphical model editor covering the Archimate standard language. We customised Archimate 'aspects' to implement the COBITA dimensions.
- **Extended Archi** for supporting new types of COBITA links. Archi natively supports 11 base types of relationships from the Archimate standard. In addition, Archi allows defining new types of relationships by specialising these base types. In the context of the present work, as shown in Figure 7, we specified the proposed new types of COBITA links by specialising the Association relationship. Note that the interface provided by Archi also gives the number of occurrences of each one of the newly specified types of links.

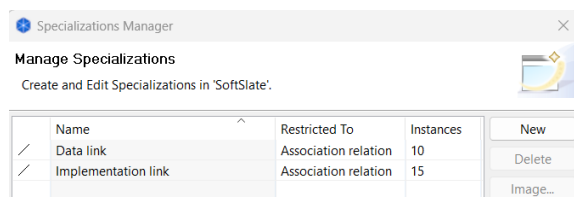

Figure 7: Specialization Manager in Archi tool for specifying new types of COBITA links.

- **jArchi** for exploiting the models and links to evaluate the alignment. jArchi is a scripting plugin provided by the developers of Archi but not integrated by default in the tool. Thus, we had to deploy and build it ourselves so that it can then be used within our Archi workbench. Thanks to jArchi, we manipulated the Archimate models, including the alignment links, in order to collect the information needed to compute the proposed metrics. We also used jArchi to navigate these models with the objective to check the proposed consistency rules. For instance, Listing 1 shows the implementation in jArchi of a script for calculating **Metric 2** (cf. Section 5). The result of the running of the script/metric is the list of all

unimplemented BPs in the model, in addition to the total number of unimplemented BPs.

Listing 1: Script in jArchi implementing our Metric 2

```
console.log('The unimplemented business
processes are : \n');
// Collect all elements of type business process
var collection = $('business-process')
//Set a counter
var count=0
//Loop on all business processes
collection.each(function(obj) {
  if($ (obj).rels('association-relationship').
    length ===0)
    {console.log(obj.name)
    count++}
})
console.log('\n There are', count, '
unimplemented business processes among',
collection.length, '. Which gives a rate of
', count/collection.length*100 ,'%')
// The actual output is the name of all business processes
that are not implemented by any COBITA link
```

The source code of the implemented components, as well as the complete models we used in the context of our experiments on our illustrative system (cf. Section 7), are all available online⁴.

7 EXPERIMENTATION

We illustrate our approach on the *SoftSlate Commerce Java shopping cart system* that powers dozens of E-commerce websites. This is a suitable candidate for performing the experiments for the following reasons: (i) We did not find available benchmark or models. (ii) A concrete implementation of this system, the *SoftSlate web application*⁵, is directly available online including its complete source code and documentation. (iii) Some business processes have already been built from this implementation by using reverse engineering techniques based on user interactions with the web application (Di Francescomarino et al., 2009). Thus, it is an interesting starting point for the modelling of the business layer. (iv) *SoftSlate* is reasonably complex in terms of structure and relatively large in terms of number of lines of code.

7.1 Modelling the Layers

Business Layer of SoftSlate. In (Di Francescomarino et al., 2009), different business processes have

³<https://www.Archimatetool.com/blog/2018/07/02/jArchi/>

⁴<https://drive.google.com/drive/folders/16rLhqmWhCITTfJ5m4Jhy0u7X8O.JGApi>

⁵<https://www.softslate.com/category/archivedDocs>

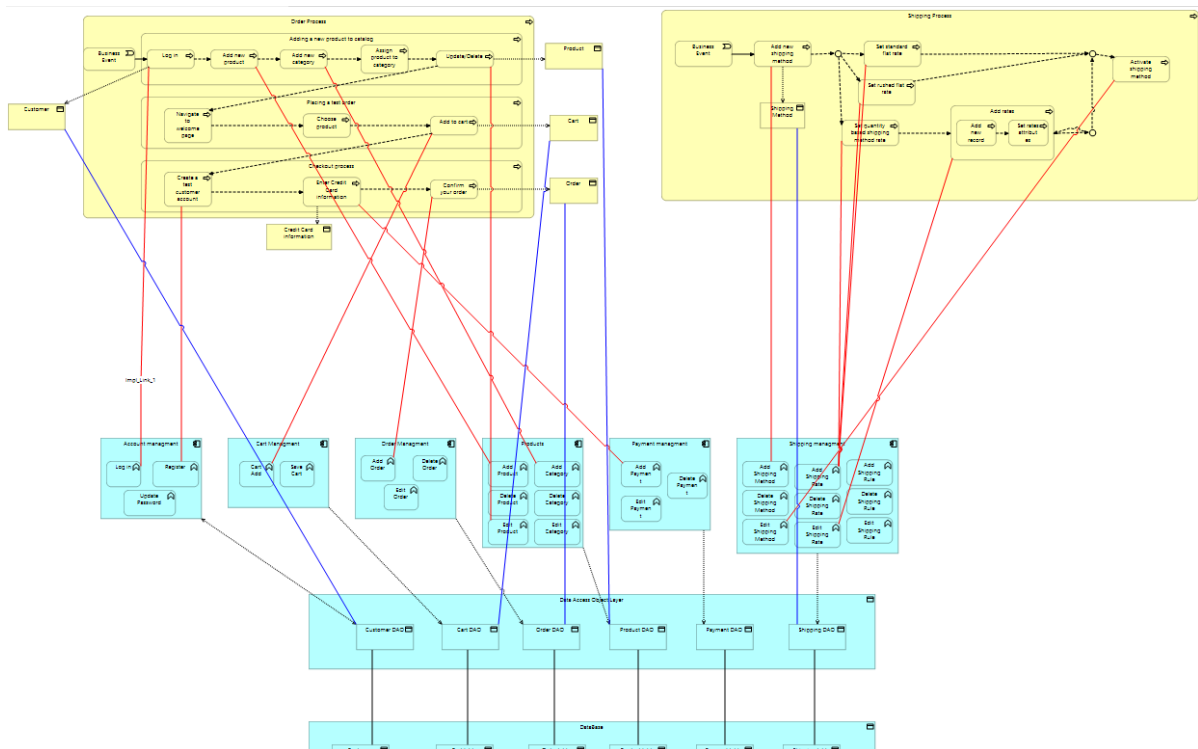

Figure 8: SoftSlate's cartography of COBITA alignment

been automatically extracted from the SoftSlate web application. They describe the main actions that customers can do with the system, namely “Login”, “Register”, and “SaveCartItem”. To complement this initial set of business processes, we also studied the provided user guide⁶. In particular, we identified additional business processes related to the system administrators in charge of managing products, orders, etc. In what follows, we focus on two of these newly identified business processes **BPs** which are modeled in yellow in Figure 8: (1) **BP1**: Add a product to the list of products & Order that product; (2) **BP2**: Configure shipping costs.

Application Layer of SoftSlate. We modeled the application artifacts by directly looking into the source code of the available implementation of SoftSlate. It is a web application developed in Java with the J2EE framework, and composed of five main packages: Customer, Administration, Business Objects, DAO, Installer. The **Customer** package and the **Administrator** package provide the core features of the system. The **Business Object** package and **DAO** package are also important because they are directly used by the **Administrator** package.

⁶<http://www.softslate.com/documentation/userGuide2x.pdf>

However, these five main packages contain a large number of sub-packages (46 in total), each one of them containing a significant number of classes. Thus, in the context of the current experiments, we focused on the **Administrator** package. The **Administrator** package contains a set of Java classes of different types by following the Model–View–Controller (MVC) software design pattern. Servlet classes implement the “Controller” part, JSP classes implement the “View” part, while Bean, Processor and DAO classes implement the “Model” part. Moreover, the **Administrator** package is responsible for implementing the previously mentioned business processes **BP1** and **BP2**.

The complete application model we built is shown in blue in Figure 8. Following a similar approach, we modeled six *Application Components*, namely “Account Management”, “Cart Management”, “Product”, “Payment”, and “Shipping”. For example, the application component *OrderProcessing* has been modeled by studying the *Order* sub-package from the *Administrator* package. This sub-package contains interrelated Java classes we represent as *application functions AFs* (Add Order, Delete Order, Edit Order). Finally, the *Order* sub-package also contains DataAccessObject (DAO) classes we represent as a single *DataObject* (OrderDAO).

7.2 Establishing COBITA links

Based on the previously described models of the business and application layers, we can move on to the next step and establish alignment links between these two layers.

Figure 8 displays the two business processes of the business layer in yellow, and the application components of the business layer in blue. We established manually multiple COBITA links between model elements from these two layers. These links are of various types (cf. Section 4) which are graphically represented by different colors. Red links correspond to implementation links (functional dimension), while the blue links correspond to representation links (data dimension).

Such a cartography is already useful to get an overview of the situation in terms of alignment. However, it is not sufficient to evaluate the actual quality of this alignment. As a consequence, a deeper analysis of the models and COBITA links is needed.

7.3 Evaluating the alignment

In what follows, we apply the different metrics we proposed in section 5.

Metric 1. Figure 9 shows the output, in the jArchi console, of the script that enables to verify if a given BP is implemented and, if this is the case, also provides the number of implementation links of that BP. The selected BP is "Log in" and has 1 implementation link *Impl_Link_1*.

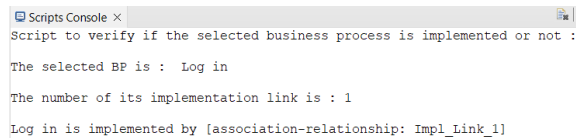

```
Scripts Console ×
Script to verify if the selected business process is implemented or not :
The selected BP is : Log in
The number of its implementation link is : 1
Log in is implemented by [association-relationship: Impl_Link_1]
```

Figure 9: Result of Metric 1 on SoftSlate

Metric 2. Figure 10 shows the output, in the jArchi console, of the script that lists all the unimplemented BPs. The number of unimplemented BPs is 10, among 24 BPs in the whole model (i.e., 41,6 % of unimplemented BPs). At first look, this number can be considered as too high. However, such a conclusion can be mitigated when analysing the unimplemented BPs. For instance, BPs such as *Order Process* and *Shipping Order* do not have implementation links to AFs. Instead, these BPs contains other BPs that are themselves implemented by AFs. Thus, Metric 2 could be refined in order not to integrate composite BPs in the computation.

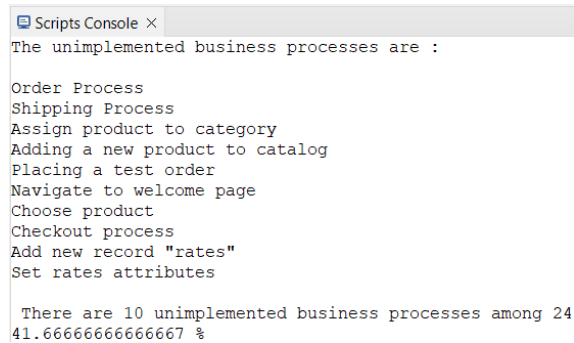

```
Scripts Console ×
The unimplemented business processes are :
Order Process
Shipping Process
Assign product to category
Adding a new product to catalog
Placing a test order
Navigate to welcome page
Choose product
Checkout process
Add new record "rates"
Set rates attributes

There are 10 unimplemented business processes among 24
41.66666666666667 %
```

Figure 10: Result of Metric 2 on SoftSlate

Metric 3. Figure 11 shows the output, in the jArchi console, of the script that lists all BPs implemented by two AFs or more. In the context of our current experiments with SoftSlate, all implemented BPs are implemented by only one implementation link. Thus, we cannot draw any particular conclusion from the result of this metric.

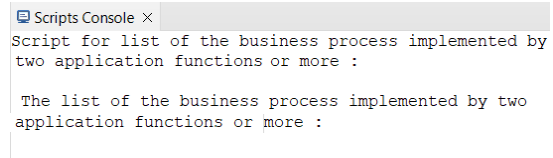

```
Scripts Console ×
Script for list of the business process implemented by
two application functions or more :

The list of the business process implemented by two
application functions or more :
```

Figure 11: Result of Metric 3 on SoftSlate

Metric 4. Figure 12 shows the output, in the jArchi console, of the script that enables to verify if a given AF is implementing any BP and, if this is the case, also provides the number of implementation links related to that AF. The selected AF is "Log in", and has one implementation link *Impl_Link_1*. This is consistent with the result of **Metric 1** since the same implementation link is considered in both cases.

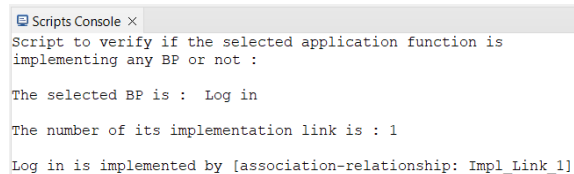

```
Scripts Console ×
Script to verify if the selected application function is
implementing any BP or not :
The selected BP is : Log in
The number of its implementation link is : 1
Log in is implemented by [association-relationship: Impl_Link_1]
```

Figure 12: Result of Metric 4 on SoftSlate

Metric 5. Figure 13 shows the output of the jArchi script that lists all the AFs that are not directly implementing BPs. The number of these AFs is 14, among 26 AFs in the whole model (i.e., 53,8 % of the AFs). Similarly to the result of **Metric 2**, this number can be considered as too high. However, once again, such a conclusion can be mitigated when analysing the non-

implementing AFs. For instance, *Update Password* is not directly implement any BP. Instead, this AF is related to a BP that is not modeled yet, i.e., a BP that allows a user to change its password. Thus, the actual coverage is likely to be better than what is currently visible in our cartography.

```

Scripts Console x
The application functions that are not implementing any BP
are as follow :

Update Password
Save Cart
Edit Order
Delete Order
Delete Product
Delete Category
Edit Category
Edit Payment
Delete Payment
Delete Shipping Method
Delete Shipping Rate
Add Shipping Rule
Edit Shipping Rule
Delete Shipping Rule

There are 14 application functions unused directly among 26 .
53.84615384615385 %

```

Figure 13: Result of Metric 5 on SoftSlate

Metric 6. As shown on Figure 14, the most used AF is "Add Shipping Rates" that implements three BPs. At first look, this highlights that this particular AF is rather important compared to other AFs. However, such a conclusion can be mitigated when analysing the concerned BPs. For example, in this case we noticed that the three BPs are coming from an *or-junction* and thus correspond to parallel processes. Thus, Metric 6 could be refined in order to also return the corresponding BPs (and not only their total number) and further analyse their dependencies.

```

Scripts Console x
Script for list of application functions implementing two application
functions or more :

The list of the application functions implementing two BPs or more :
Add Shipping Rate

```

Figure 14: Result of Metric 6 on SoftSlate

We illustrated a few metrics to evaluate quantitative aspects such as completeness ratios. Indicators are built on a hierarchic aggregation of simpler metrics. There remains work to compute alignment indicators to assert that alignment is achieved at X%. We will discuss metrics as one feature of the next section.

8 RELATED WORK

We studied the related work contributing to inter-layers links, alignment evaluation and tooling. In each case, we discuss layers modelling, links, evaluation,

tooling and experimentation. A general and more detailed comparison of COBITA approaches can be found in a previous study (André et al., 2023).

Aversano et al. propose a BITA framework with tool support (Aversano et al., 2016). They use UML diagrams for layers modelling. The inter-layer links are 'functions' from business entities (activities) to software components (operations, artifact classes). The evaluation of alignment considers two attributes (Technological Coverage and Technological Adequacy) performed on activities, actors, artefacts and transitions. The results are then aggregated by summing the values of the computed metrics in order to calculate a degree of alignment that covers a wider scope than COBITA, including strategy. The overall approach is a major reference because it covers the range from links to tool support with special contribution to metrics to suggest evolution actions. Unfortunately, both the tool and the SantaClaus case study are not publicly available. They propose a semantic analysis based on identifiers and lexical information which becomes pertinent only if the IS provider use strict development rules uncluding traceability information, which is rarely the case. Also the alignment is based mainly on the functional dimension and provide limited analysis. We are convinced that multi-dimension increases the power of alignment evaluation (consistency verification, alignment metrics) by providing various kind of alignment patterns combining data and functions for example.

The work of Etien et al. (Etien and Rolland, 2005) is based on ontologies. In their approach, alignment is called 'fitness' because it is centered on metrics. The authors define two types of links: *maps* is an inter-layer link, and *represents* is an abstraction of inter-layer link at the concept level of the ontologies. The evaluation part leans on ten different metrics. These metrics represent four factors (intentional - informational - functional - dynamic) which are inspired by a reference software quality measurement framework (Cavano and McCall, 1978). Experimentations are led on a Renault/DIAC case study. Unfortunately, it is not publicly available. This work is really a reference in terms of metrics. However it suffers from several weaknesses: (i) Ontologies are not common notations for EA architects and requires to develop tools for input/output. (ii) Like other BITA approaches (Castellanos and Correal, 2013; Sánchez et al., 2020), it is inspired from Ontology alignment (Euzenat et al., 2008) that aims to *match* 'similar' concepts. However business layers and application layers may have very different concepts, especially in legacy systems where software components and application may be defined while service

and functions may not. (iii) There miss tool support at every stage.

The work of Pepin et al. covers the full range of activities for COBITA (Pepin et al., 2016) Three layers are involved: business (BPM), application (App) and functional (Fun) where Fun denotes an urbanisation concern with blocks and functionalities. Fun corresponds to Enterprise Architecture practice in French companies (Longép , 2003). A link metamodel is provided that distinguishes data and functions. The alignment is implemented by model weaving to remain non-intrusive on the layer models, that enables OCL-like requests on the full model. It is evaluated through consistency rules, and completeness metrics and clustering techniques that provide an alignment dashboard. Tooling focuses on reverse-engineering source code to feed the App models, a plug-in of the EMF Facet project to define and query the inter-layer links, and OCL queries to evaluate alignment. The experimentations are led with three legacy cases provided by three French insurance companies, not publicly available. This work is really close to us because it focuses on COBITA in practice and provides both guidelines and tools. However, ad-hoc layer models is a weakness to pervasive EA practice. We rather advocate for relying on standard notations. Also having three layers to align instead of two is not usual in COBITA practice. If the dimensions cover the three layers, it really becomes tricky to capture the links. In our approach, the dimension paradigm enables to filter the various stakeholder concerns. Similarly, the detection of anti-patterns is easier using two layers with dimensions rather than three layers.

Some works provide rich inter-layer links (K ster et al., 2016; Buchwald et al., 2012; Kassahun and Tekinerdogan, 2020) that play a role of mapping layer between the model layers. These approaches are interesting in terms of alignment tuning and evolution. In particular, (K ster et al., 2016) accepts several models for each layer. The links of (Buchwald et al., 2012) play the role of transformation operators which is an operational vision of COBITA to implement business process, while COBITA addresses also the problem of aligning legacy code. In (Kassahun and Tekinerdogan, 2020), alignment applies between business layers (BP2BP), IT-Layers (IT2IT) and between Business-IT layers (BP2IT). The BT2IT alignment considers allocation and alignment models. Providing general rules for those alignments is very confusing for the EA analysts because there clearly exist at least two different semantics of alignment. The problem of such rich inter-layer links is that they require much work for alignment while EA analysts require as much automation as possible. Also

the alignment evaluation and tool support is less reusable in other contexts.

Compared to the related works, our contribution brings out insights on alignment mapping embodied by the dimension-oriented typology of links. We provide explicit links with a clear representation and semantics, easy to compute into EA layer models. This enables further insights related to alignment evaluation and exploitation. Moreover, we focus on evaluating alignments with operational means while other approaches focus on change impact and evolution, that we consider at a future step.

9 CONCLUSION AND PERSPECTIVES

In this paper, we proposed a method for establishing Core Business-IT Alignment (COBITA) links and evaluating them in order to evaluate the quality of the alignment. We first selected the concepts from the Business and Application layers which are relevant for COBITA. Then we defined two kind of inter-layer links, one for the functional dimension and the other for functional dimension. Based on these links, we proposed metrics and consistency rules to evaluate the alignment. We implemented the models and links in Archi, the reference Archimate tool, and the evaluation means with jArchi a script language extension of Archi. The results of our initial experiments show that the proposed approach is applicable in the context of a realistic information system like SoftSlate. This case could be reuse by the community as a common benchmark for COBITA experiments.

With this paper we reached a first milestone, like a first sprint covering the whole alignment process in an Agile vision. However, there is still room for improvement concerning several aspects of the approach. First, we worked on very general links while, in Archimate (for example), different relationships can be used and provide a finer semantics for inter-links. Second, more work is needed to enrich the provided library of metrics and consistency rules. We will also have to work on their aggregation as adequate indicators to be inserted in dashboards. The objective is to support the architects in detecting issues or asserting a quality level. To this end, a more elaborated taxonomy of possible COBITA links could be proposed in order to further improve the quality of the cartography in terms of alignment links. Third, we manually fed the models and links so far but assistance is crucially requested by the architects for such a task, e.g., concerning the application layer *e.g.* (Aversano et al., 2016; Pepin et al., 2016) or the links

(e.g. (Sánchez et al., 2020) for function refinement). Finally, there are COBITA areas we did not study yet and we plan to address in future work, such as change impact and evolution (Aversano et al., 2016; Dahman et al., 2013; Sánchez et al., 2020).

REFERENCES

- André, P., Tamzalit, D., Benjlany, A., and Bruneliere, H. (2023). A review of core operational business-it alignment. In ISD 2023 Proceedings, pages 1–12, Lisbon, Portugal. AIS eLibrary.
- Aversano, L., Grasso, C., and Tortorella, M. (2016). Managing the alignment between business processes and software systems. Information and Software Technology, 72:171–188.
- Buchwald, S., Bauer, T., and Reichert, M. (2012). Bridging the gap between business process models and service composition specifications. In Service Life Cycle Tools and Technologies: Methods, Trends and Advances, pages 124–153. IGI Global.
- Castellanos, C. and Correal, D. (2013). A framework for alignment of data and processes architectures applied in a government institution. J. Data Semant., 2(2-3):61–74.
- Cavano, J. P. and McCall, J. A. (1978). A framework for the measurement of software quality. In Proceedings of the Software Quality Assurance Workshop on Functional and Performance Issues, page 133–139, New York, NY, USA. Association for Computing Machinery.
- Dahman, K., Charoy, F., and Godart, C. (2013). Alignment and change propagation between business processes and service-oriented architectures. In IEEE SCC 2013, Santa Clara, CA, USA, pages 168–175. IEEE Computer Society.
- Di Francescomarino, C., Marchetto, A., and Tonella, P. (2009). Reverse engineering of business processes exposed as web applications. In 2009 13th European Conference on Software Maintenance and Reengineering, pages 139–148. IEEE.
- Etien, A. and Rolland, C. (2005). Measuring the fitness relationship. Requirements Engineering, 10(3):184–197.
- Euzenat, J., Mocan, A., and Scharffe, F. (2008). Ontology Alignments, pages 177–206. Springer US, Boston, MA.
- Gellweiler, C. (2021). IT architects and it-business alignment: a theoretical review. In CENTERIS 2021 - ProjMAN 2021 - HCist 2021, Braga, Portugal, volume 196, pages 13–20. Elsevier.
- Gero, J. S. and Kannengiesser, U. (2014). The Function-Behaviour-Structure Ontology of Design, pages 263–283. Springer London, London.
- Gouigoux, J.-P. and Tamzalit, D. (2021). Business-IT alignment anti-patterns: a thought from an empirical point of view. In ISD 2021, Valencia, Spain.
- Habba, M., Fredj, M., and Benabdellah Chaoui, S. (2019). Alignment between business requirement, business process, and software system: a systematic literature review. Journal of Engineering, 2019.
- Henderson, J. C. and Venkatraman, H. (1999). Strategic alignment: Leveraging information technology for transforming organizations. IBM Systems, 38(2.3):472–484.
- ISO/IEC/IEEE (2011). Systems and software engineering – architecture description. ISO/IEC/IEEE 42010:2011(E), pages 1–46.
- Kassahun, A. and Tekinerdogan, B. (2020). Bit*: Business-it alignment framework of multiple collaborating organisations. Information and Software Technology, 127:106345.
- Küster, J. M., Völzer, H., Favre, C., Branco, M. C., and Czarnecki, K. (2016). Supporting different process views through a shared process model. Softw. Syst. Model., 15(4):1207–1233.
- Lankhorst, M. M. (2013). Enterprise Architecture at Work - Modelling, Communication and Analysis (3. ed.). The Enterprise Engineering Series. Springer.
- Longépé, C. (2003). The enterprise architecture IT project: the urbanisation paradigm. Elsevier.
- Pepin, J., André, P., Attiogbé, J. C., and Breton, E. (2016). An improved model facet method to support EA alignment. Complex Systems Informatics and Modeling Quarterly, 9:1–27.
- Sánchez, E. S., Clemente, P. J., Conejero, J. M., and Prieto, A. E. (2020). Business process execution from the alignment between business processes and web services: A semantic and model-driven modernization process. IEEE Access, 8:93346–93368.
- Zhang, M., Chen, H., and Luo, A. (2018). A systematic review of business-it alignment research with enterprise architecture. IEEE Access, 6:18933–18944.