



HAL
open science

Quantum entanglement in condensed matter

Grégoire Misguich

► **To cite this version:**

Grégoire Misguich. Quantum entanglement in condensed matter. Doctoral. Institut de Physique Théorique, CEA Saclay, France. 2015, pp.104. hal-04446225

HAL Id: hal-04446225

<https://hal.science/hal-04446225v1>

Submitted on 8 Feb 2024

HAL is a multi-disciplinary open access archive for the deposit and dissemination of scientific research documents, whether they are published or not. The documents may come from teaching and research institutions in France or abroad, or from public or private research centers.

L'archive ouverte pluridisciplinaire **HAL**, est destinée au dépôt et à la diffusion de documents scientifiques de niveau recherche, publiés ou non, émanant des établissements d'enseignement et de recherche français ou étrangers, des laboratoires publics ou privés.



Distributed under a Creative Commons Attribution - NonCommercial - ShareAlike 4.0 International License

Quantum entanglement in condensed matter

Grégoire Misguich (IPhT, CEA Saclay)

<http://ipht.cea.fr/Pisp/gregoire.misguich>

gregoire.misguich@cea.fr



IPhT Lectures
& Ecole doctorale "Physique en île de France" (ED-PIF)

May 22th & 29th, June 5th and 12th, 2015

INTRODUCTION

motivations, plan

basic definitions: reduced density matrix,
entanglement entropy, Schmidt decomposition,
Rényi entropies, ...

Why studying quantum entanglement ?

(in the many-body systems encountered in condensed matter)

□ A powerful *theoretical probe* for quantum many-body systems. In particular, the scaling of the entanglement entropy can reveal most of the long-distance properties of the system.

Celebrated example: $S_{\text{Von Neumann}} \sim \frac{c}{3} \log(l)$ for critical quantum chains, relating the central c charge of the underlying CFT to the ground-state entanglement.

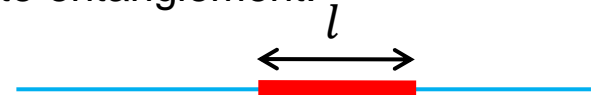

□ Understanding entanglement is useful to construct *new algorithms* to compute & store efficiently quantum (many-body) states in a computer, to simulate their evolution, or construct some variational ansatz (tensor networks etc.).

□ Quantum entanglement is at the core of *quantum information processing* (quantum cryptography and quantum computation, adiabatic quantum computation)

But...

□ It is very hard to measure experimentally

Answering condensed-matter questions by studying entanglement

□ “Conventional” approach

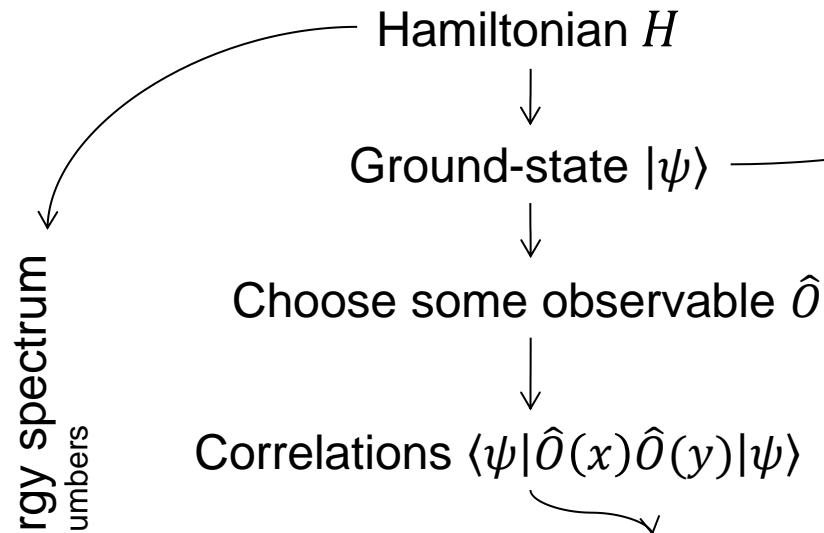

Characterize the state of matter
(long distance & low energy properties)

- Long-range order and spontaneous symmetry breaking ?
- Criticality / algebraic correlations ?
- Excitation spectrum, gap / gapless ?
- Unconventional (i.e. topological) order ?
- Fractional excitations ?
- Gapless edge modes ?

□ “Entanglement-based” approach

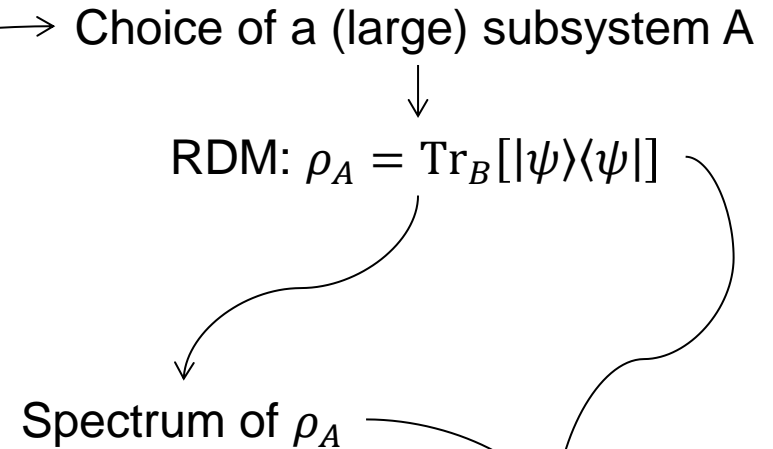

Scaling of $S_A = -\text{Tr}_B[\rho_A \log \rho_A]$
with the size and shape of A

Focus of these lectures ...

□ Entanglement between **two spatial regions** of the system : In most cases the total system A+B will be in a **pure state** (wave-function $|\psi\rangle$). We will not discuss multipartite entanglement, or other partition schemes (particles, momentum space, ...)

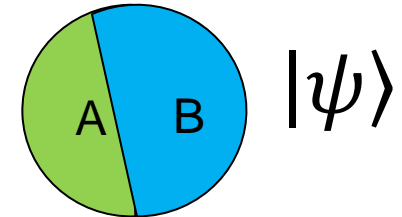

- Situations where A & B contain a **large number of degrees of freedom**
- State $|\psi\rangle$: ground state of some condensed-matter lattice model (ex: spins, fermions, ...)
- We will *not* discuss :
 - disordered systems and many-body localization
 - the theory of quantum measurements (w.-f. collapse, etc)
 - physical mechanisms and characterization of decoherence (system interacting with an environment). More generally, will we say very little about experiments ☹
 - quantum computers and the role of entanglement in quantum algorithms

Outline

- Lecture #1
 - I. Introduction - why studying quantum entanglement ?
 - II. Basic definitions
 - Reduced density matrix (RDM), entanglement (Von Neumann) entropy
 - Schmidt decomposition, singular-value decomposition, replica trick, Rényi entropies, ...
 - III. A proposal to measure (Rényi) entanglement entropies
 - IV. Area law:
 - I. General idea
 - II. Mutual information & area law at $T>0$
 - III. $T=0$ & mutual information correlation length (*Wolf et al. 2008*)
 - IV. Hastings' theorem in 1d (2007)
- Lecture #2
 - V. High energy states: volume law for the entanglement entropy, thermal entropy and the eigenstate thermalization hypothesis (ETH)
 - VI. Free fermions and bosons
 - 1. Gaussian reduced density matrix & correlation functions (*Peschel 2003*)
 - 2. Exactly solvable example: entropy of a segment in a free fermion chain (1d Fermi sea)
 - 3. Violation of the boundary law (multiplicative log) in presence of a Fermi surface in $d>1$ (*Gioev & I. Klich 2006*)
- Lecture #3
 - VII. CFT & Entanglement in critical 1d systems (*Holzhey et al. '94*)
 - VIII. Matrix product states
 - I. Canonical MPS form & entanglement
 - II. Real time evolution (Vidal's TEBD)
- Lecture #4
 - IX. Some examples of (universal) corrections to the area law in 2d
 - X. Bulk-edge correspondence
 - 1. Bulk-edge correspondence in 2d (*Li-Haldane 2008* & *Qi-Katsura-Ludwig 2012*)
 - 2. Example of a spin ladder (*Poiblanc 2010, Pechel & Chung 2011*)
 - 3. Topological entanglement entropy (*Kitaev-Preskill & Levin-Wen 2006*)

Some reviews

❑ “*Entanglement in many-body systems*”

L. Amico, R. Fazio, A. Osterloh, and V. Vedral, [Rev. Mod. Phys. 80, 517 \(2008\)](#)

❑ “Quantum entanglement”

R. Horodecki, P. Horodecki, M. Horodecki, and K. Horodecki, [Rev. Mod. Phys. 81, 865 \(2009\)](#)

❑ “*Entanglement entropy in extended quantum systems*” ,

editors: P. Calabrese, J. Cardy & B. Doyon, [J. Phys A, Special issue \(2009\)](#)

❑ “*Quantum Entanglement in Condensed Matter Physics*” ,

editors: S. Rachel, M. Haque, A. Bernevig, A. Laeuchli and E. Fradkin
[J. Stat. Mech.: Th. and Experiment, Special Issue \(2014-2015\)](#)

Product states & entanglement

- Separate the degrees of freedom into two blocks, and two Hilbert spaces $\mathcal{H} = \mathcal{H}_A \otimes \mathcal{H}_B$
- A and B are not entangled $\Leftrightarrow |\psi\rangle$ is a product state $|\psi\rangle = |a\rangle \otimes |b\rangle$
- A and B are Entangled $\Leftrightarrow |\psi\rangle$ cannot be written as a product state
- Standard 2-spin examples

- Products:

$$|\psi\rangle = |\uparrow_1 \uparrow_2\rangle$$

$$|\psi\rangle = |\uparrow\uparrow\rangle + |\uparrow\downarrow\rangle + |\downarrow\uparrow\rangle + |\downarrow\downarrow\rangle = (|\uparrow\rangle + |\downarrow\rangle)_1 \otimes (|\uparrow\rangle + |\downarrow\rangle)_2$$

- Not products:

$$|\psi\rangle = |\uparrow\uparrow\rangle + |\downarrow\downarrow\rangle$$

$$|\psi\rangle = |\uparrow\downarrow\rangle - |\downarrow\uparrow\rangle$$

- What about $|\psi\rangle = \alpha|\uparrow\uparrow\rangle + \beta|\uparrow\downarrow\rangle + \gamma|\downarrow\uparrow\rangle + \delta|\downarrow\downarrow\rangle$?

- What if $|\psi\rangle$ is the ground state of the spin-1/2 Heisenberg model on a chain of length L ?

$$H = \sum_n \vec{S}_n \cdot \vec{S}_{n+1}$$

$$H|\psi\rangle = E_0 |\psi\rangle$$

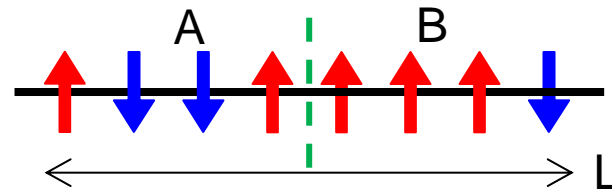

→ Some way to quantify the amount of (bi partite) entanglement is needed

Reduced density matrix (definition)

□ Definition: $\rho_A = \text{Tr}_B[\rho_{AB}]$ “tracing out the degrees of freedom of B”

□ 2-spin example: General pure state $|\psi\rangle = \alpha|\uparrow\uparrow\rangle + \beta|\uparrow\downarrow\rangle + \gamma|\downarrow\uparrow\rangle + \delta|\downarrow\downarrow\rangle$

Reduced density matrix for A = spin 1: $\rho_{\text{spin } 1} = \text{Tr}_{\text{B=spin } 2}[|\psi\rangle\langle\psi|]$

Matrix elements: $\langle\sigma_1|\rho_1|\sigma_1'\rangle = \sum_{\sigma_2=\uparrow,\downarrow}\langle\sigma_1\sigma_2|\psi\rangle\langle\psi|\sigma_1'\sigma_2\rangle$

$$\langle\sigma_1|\rho_1|\sigma_1'\rangle = \langle\sigma_1\uparrow|\psi\rangle\langle\psi|\sigma_1'\uparrow\rangle + \langle\sigma_1\downarrow|\psi\rangle\langle\psi|\sigma_1'\downarrow\rangle$$

$$\rho_1 = \begin{bmatrix} |\alpha|^2 + |\beta|^2 & \bar{\gamma}\alpha + \bar{\delta}\beta \\ \bar{\alpha}\gamma + \bar{\beta}\delta & |\gamma|^2 + |\delta|^2 \end{bmatrix}$$

□ General formula: $|\psi\rangle = \sum_{ij} M_{ij}|a_i\rangle\otimes|b_j\rangle \rightarrow \langle a_i|\rho_A|a_{i'}\rangle = \sum_j M_{ij}\overline{M_{i'j}} = (MM^\dagger)_{ii'}$

Remark: $MM^\dagger \rightarrow$ positive eigenvalues. Since $\text{Tr}_A[\rho_A] = 1$, all the eigenvalues must be $\in [0,1]$.

□ Basic properties

✓ Hermitian

✓ Expectation values of observables acting on subsystem A can be computed using ρ_1 :

$$\langle\psi|O_A|\psi\rangle = \text{Tr}_{A,B}[|\psi\rangle\langle\psi|O_A] = \text{Tr}_A[\rho_A O_A]$$

✓ $\text{Tr}_A[\rho_A] = \text{Tr}_{AB}[\rho_{AB}] = 1$. Example: $\text{Tr}_{\text{spin } 1}[\rho_1] = |\alpha|^2 + |\beta|^2 + |\gamma|^2 + |\delta|^2 = \langle\psi|\psi\rangle = 1$

✓ The two subsystems are not entangled $\Leftrightarrow |\psi\rangle = |a\rangle\otimes|b\rangle \Leftrightarrow \rho_1$ is a projector ($\rho_1 = |a\rangle\langle a| \Leftrightarrow$ eigenvalues $\{p_i\}$ of ρ_1 are 1 (non-degenerate) and 0.

Schmidt decomposition (1)

Pure state $|\psi\rangle \in \mathcal{H}_A \otimes \mathcal{H}_B$, $|a_i\rangle$ basis of \mathcal{H}_A , $|b_j\rangle$ basis of \mathcal{H}_B

$$|\psi\rangle = \sum_{ij} M_{ij} |a_i\rangle \otimes |b_j\rangle$$

M rectangular matrix: $[m = \dim(\mathcal{H}_A)] \times [n = \dim(\mathcal{H}_B)]$

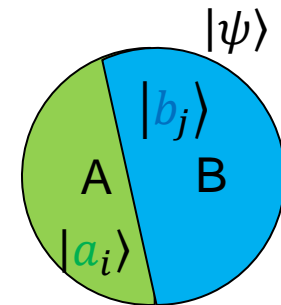

Singular value decomposition (SVD) of M :

\exists unitary matrices U (size m) and V (size n), and a “diagonal” one λ (=singular values of M , real and non-negative)

such that $M = UV^\dagger$

$$\begin{array}{c} n \\ \boxed{M} \\ m \end{array} = \begin{array}{c} m \\ \boxed{U} \\ m \end{array} \times \begin{array}{c} n \\ \boxed{\lambda_k} \\ 0 \end{array} \times \begin{array}{c} n \\ \boxed{V^\dagger} \\ n \end{array}$$

We can rewrite $|\psi\rangle$ as: $|\psi\rangle = \sum_{ijk} U_{ik} \lambda_k V_{kj}^\dagger |a_i\rangle \otimes |b_j\rangle$

Then we define $|u_k\rangle = \sum_i U_{ik} |a_i\rangle$, $|v_k\rangle = \sum_j \bar{V}_{jk} |b_j\rangle$.

Orthogonality property: $\langle u_k | u_{k'} \rangle = \delta_{k,k'} = \langle v_k | v_{k'} \rangle$

And finally we get the Schmidt decomposition of $|\psi\rangle$:

$$|\psi\rangle = \sum_k \lambda_k |u_k\rangle \otimes |v_k\rangle$$

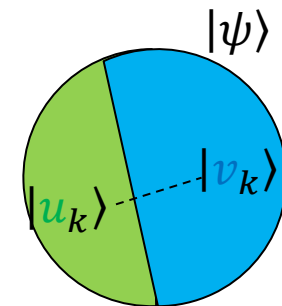

Schmidt decomposition (2)

Recall : $|\psi\rangle = \sum_k \lambda_k |u_k\rangle \otimes |v_k\rangle$

□ Reduced density matrices & their spectrum

$\rho_A = \text{Tr}_B[|\psi\rangle\langle\psi|] = \sum_k |\lambda_k|^2 |u_k\rangle\langle u_k| \rightarrow$ the eigenvalues of ρ_A are the $|\lambda_k|^2$

$\rho_B = \text{Tr}_A[|\psi\rangle\langle\psi|] = \sum_k |\lambda_k|^2 |v_k\rangle\langle v_k| \rightarrow$ the eigenvalues of ρ_B are the $|\lambda_k|^2$

\rightarrow Both RDM have the same non-zero eigenvalues

\rightarrow symmetry of the Von Neumann entropy: $S_A = S_B$

□ “Purification”: if ρ_A describes some mixed state of some system A , one can construct a pure state $|\psi\rangle$ in some enlarged system AA' such that

$\rho_A = \text{Tr}_{A'}[|\psi\rangle\langle\psi|]$. Solution: A' = “copy of A ”. Diagonalize ρ_A : $\rho_A = \sum_k p_k |k\rangle\langle k|$ and define the entangled wave-function: $|\psi\rangle = \sum_k \sqrt{p_k} |k\rangle_A \otimes |k\rangle_{A'}$

□ A separate unitary “evolution” of regions A and B does *not* change the Schmidt eigenvalues:

$$e^{-it(H_A+H_B)}|\psi\rangle = U_A U_B |\psi\rangle = \sum_k \lambda_k (U_A |u_k\rangle) \otimes (U_B |v_k\rangle)$$

= still a valid Schmidt decomposition

$\rightarrow \lambda_k$ unchanged, and constant entanglement entropy

Schmidt decomposition (3) – Optimal approximation

- What is the best approximation to $|\psi\rangle$ with a given lower Schmidt rank $\chi < r$?

$$|\psi\rangle = \sum_{kl} M_{kl} |a_k\rangle |b_l\rangle = \sum_{k=1}^r \lambda_k |u_k\rangle |v_k\rangle \quad \left\{ \begin{array}{l} \lambda_1 \geq \lambda_2 \geq \dots \geq \lambda_r \geq 0 \\ \text{SVD: } M = USV^\dagger \end{array} \right.$$

- Answer: truncate the Schmidt decomposition above, keeping only the χ largest values (and re-normalize the state):

$$|\psi_\chi\rangle = \frac{1}{\sqrt{\sum_{k=1}^{\chi} (\lambda_k)^2}} \sum_{k=1}^{\chi} \lambda_k |u_k\rangle |v_k\rangle$$

$$\langle \psi | \psi_\chi \rangle = \sqrt{1 - \sum_{k=\chi+1}^r (\lambda_k)^2}$$

- « Proof »:

- Note that the Hilbert space norm is equivalent to Frobenius norm $\|\dots\|_F$ for the matrix M : $\|M\|_F^2 = \text{Tr}[MM^\dagger] = \sum_{kl} |M_{kl}|^2 = \langle \psi | \psi \rangle$
- Use the Eckart and Young theorem (1936), which states that the best approximation (in the sense of $\|\dots\|_F$) of rank $\chi \leq r$ to the matrix M is the matrix $M(\chi)$ obtained by truncating the SVD decomposition of M to its χ largest singular values.

Remark: the proof of this theorem is somewhat “tricky” and not discussed here... Note that this solution to the optimization problem is also optimal for the norm $\|\dots\|_2$ -- for which the proof is simpler.

Schmidt decomposition (4) – SVD on a computer

- ❑ Complexity for an $M * N$ matrix: $\mathcal{O}(\min(M * N^2, N * M^2))$

NB: To be compared with a two-step procedures: i) Computing ρ_A : $\mathcal{O}(N * M^2)$ and then ii) diagonalizing ρ_A : $\mathcal{O}(M^3)$.

- ❑ LAPACK: **dgesvd**

- ❑ GSL: **gsl_linalg_SV_decomp**

- ❑ Numerically stable

- ❑ Sometimes the SVD is overkill if the Schmidt values are not needed (just some orthogonal basis on one “side”, as often in DMRG for instance) and a QR factorization is enough (faster).

SVD, decay of the singular values & data compression (2)

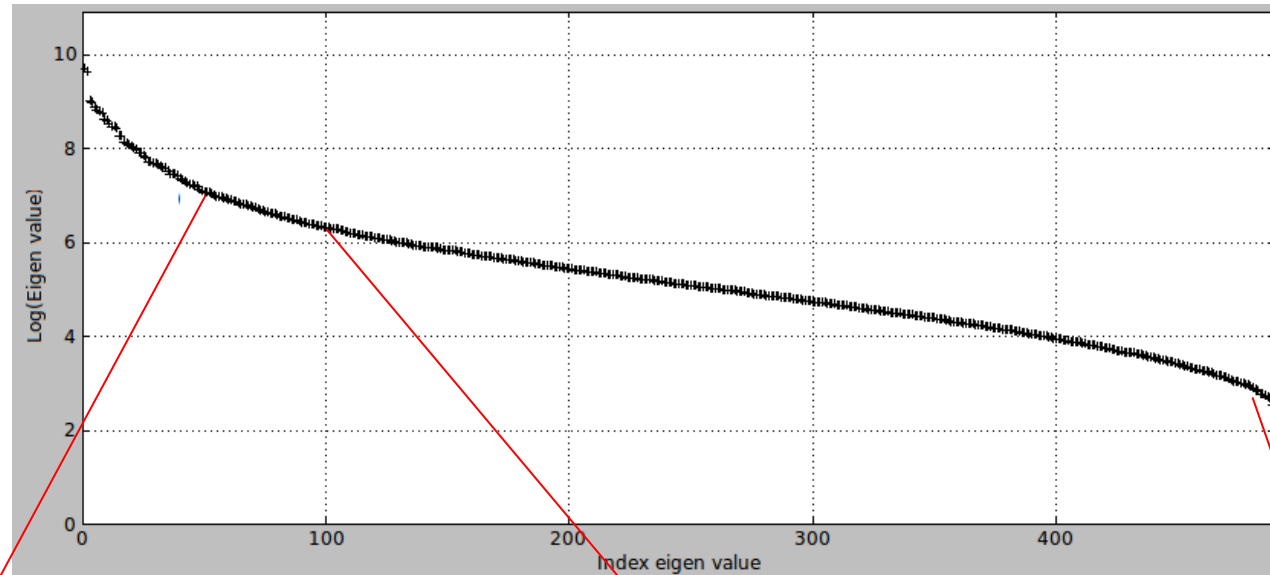

Rank 50



Rank 100



Rank 490

SVD, decay of the singular values & data compression (1)

An (color) image viewed as a (three) matrix(ces)



Rank 189

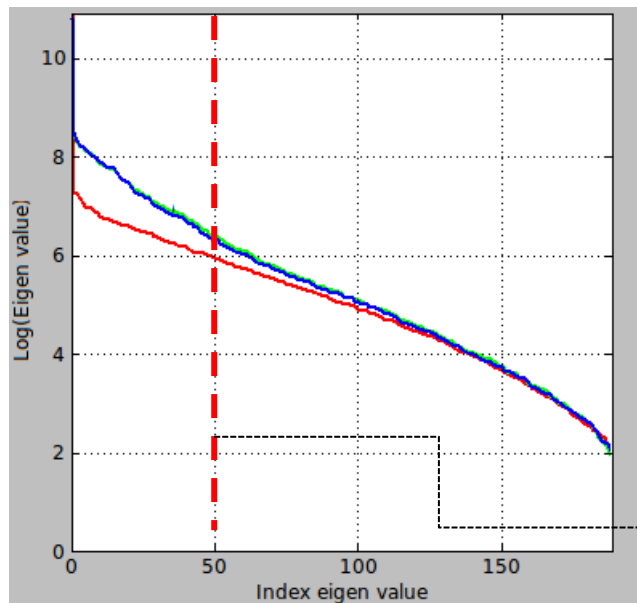

Rank 10



Rank 20



Rank 50

Von Neumann entropy (definition)

- Von Neumann/entanglement entropy

$$S_A = -\text{Tr}_B[\rho_A \log \rho_A] = -\sum_i p_i \log p_i$$

With $\rho_A = \text{Tr}_B[\rho_{AB}]$, and $\{p_i\}$ the eigenvalues of ρ_A .

- $S_A = 0 \Leftrightarrow \rho_A$ is a projector $\Leftrightarrow |\psi\rangle$ is a product state \Leftrightarrow region A is in a pure state

Remark: For a thermal density matrix $\rho \sim e^{-\beta H}$, the same formula gives the Boltzmann-Gibbs entropy

“You should call it entropy, for two reasons. In the first place your uncertainty function has been used in statistical mechanics under that name, so it already has a name. In the second place, and more important, no one really knows what entropy really is, so in a debate you will always have the advantage.”

J. Von Neumann, suggesting to Claude Shannon a name for his new uncertainty function, as quoted in Scientific American **225**, 3, p180 (1971).

Von Neumann entropy – basic properties

- $S(\rho)$ is zero if and only if ρ represents a pure state (projector)
- $S(\rho)$ is maximal and equal to $\log N$ for a maximally mixed state, N being the dimension of the Hilbert space.
- $S(\rho)$ is invariant under changes in the basis of ρ , that is, $S(\rho) = S(U\rho U^\dagger)$, with U unitary.
- Concavity $S(\sum_i \lambda_i \rho_i) \geq \sum_i \lambda_i S(\rho_i)$
- Independent systems : $S(\rho_A \otimes \rho_B) = S(\rho_A) + S(\rho_B)$
- If ρ_{AB} describe a pure state, $S(\rho_B) = S(\rho_A)$ (proof using the Schmidt decomposition, see next)

- A,B,C: 3 parts, without intersection
 - Strong sub-additivity [SS] $S(\rho_{ABC}) + S(\rho_B) \leq S(\rho_{AB}) + S(\rho_{BC})$
 - Equivalent formulation: $S_{X \cup Y} + S_{X \cap Y} \leq S_X + S_Y$
Proof: difficult ! E. H. Lieb, M. B. Ruskai, “Proof of the Strong Subadditivity of Quantum Mechanical Entropy”, [J. Math. Phys. 14, 1938 \(1973\)](#)
 - Subadditivity $S(\rho_{AC}) \leq S(\rho_A) + S(\rho_C)$ (obtained by setting $B = \emptyset$ in SS above, but direct proof is possible a much much simpler than SS)

- Araki-Lieb triangular inequality: $S(\rho_{AC}) \geq |S(\rho_A) - S(\rho_C)|$
Simple proof using i) some auxiliary *pure* state ρ_{ABC} in some enlarged space such that $\text{Tr}_B[\rho_{ABC}] = \rho_{AC}$, $\text{Tr}_{BC}[\rho_{ABC}] = \rho_A$ and $\text{Tr}_{AB}[\rho_{ABC}] = \rho_C$, ii) the sub-additivity above for ρ_{BC} and iii) $S(\rho_{BC}) = S(\rho_A)$ and $S(\rho_B) = S(\rho_{AC})$ (since ρ_{ABC} is pure).

A simple exercise with strong subadditivity

- Let $S(x)$ be the entanglement entropy of a segment of length x in a periodic and translation invariant spin chain of total length L (in a pure state).
- How to prove that $S(x)$ is a *concave* function of x and that it is maximal for $x = L/2$? (unless it is constant and equal to zero).

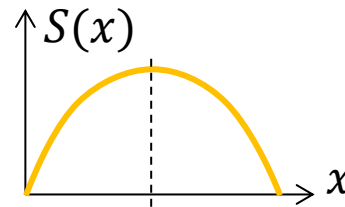
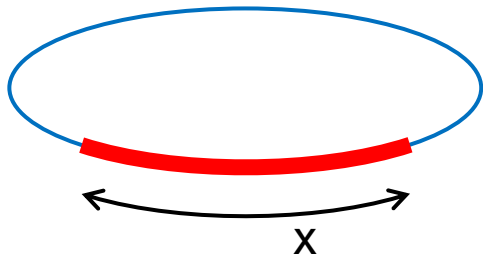

- Answer: use the strong sub-additivity with the three following consecutive segments $A = \{0\}$, $B = \{1, 2, \dots, x - 1\}$ and $C = \{x\}$:

$$S_{ABC} + S_B \leq S_{AB} + S_{BC}$$

$$S(x + 1) + S(x - 1) \leq 2S(x) \rightarrow \text{concavity}$$

+ symmetry $S(x) = S(L - x)$

Rényi entropies & Replica trick

- If you can compute the spectrum of ρ_A ...
then you get S_A by summing over all the eigenvalues:

$$S_A = -\text{Tr}[\rho_A \log(\rho_A)] = -\sum_i p_i \log(p_i)$$

- If not... you can
 - compute $\text{Tr}[\rho_A^n]$ for integer $n \geq 2$ (easier than computing the spectrum)
 - (cross your fingers &) analytically continue the result to $n=1$
 - use:

$$-\text{Tr}[\rho_A \log(\rho_A)] = \lim_{n \rightarrow 1} \frac{1}{1-n} \log(\text{Tr}[\rho_A^n])$$

- Rényi entropies are also often interesting, and simpler to compute & measure [in principle]

$$S_A(n) = \frac{1}{1-n} \log(\text{Tr}[\rho_A^n])$$

NB: Rényi entropies (integer $n \geq 2$) can be measured in Quantum Monte Carlo:

“*Measuring Rényi Entanglement Entropy in Quantum Monte Carlo Simulations*”

M. B. Hastings, I. González, A. B. Kallin, and R. G. Melko, [Phys. Rev. Lett. 104, 157201 \(2010\)](#)

- They share some properties with the Von Neumann entropy:
 - Positive $S_A(n) \geq 0$
 - Additive for uncorrelated systems $S_{AB}(n) = S_A(n) + S_B(n)$ if $\rho_{AB} = \rho_A \otimes \rho_B$
 - But *no* subadditivity

Entanglement spectrum - definition

$$|\psi\rangle = \sum_i \lambda_i |a_i\rangle |b_i\rangle$$

Schmidt decomposition

$$\lambda_i > 0, \quad p_i = (\lambda_i)^2, \quad \sum_i p_i = 1$$

$$p_i = \frac{\exp(-E_i)}{Z(1)} \quad \text{with} \quad Z(n) = \sum_i e^{-nE_i}$$

Interpret the eigenvalues of ρ_A as classical Boltzmann weights. This defines some “energies” E_i

$$\text{Tr}[\rho_A^n] = \sum_i (p_i)^n = \frac{Z(n)}{Z(1)}$$

$Z(n)$: Partition function at inverse temperature $\frac{1}{T} = \beta = n$

$$|\psi\rangle = \frac{1}{\sqrt{Z(1)}} \sum_i e^{-\frac{E_i}{2}} |a_i\rangle |b_i\rangle$$

Free energy

$$F(n) = -\frac{1}{n} \log(Z(n)) = -\frac{1}{n} \log(Z(1) \text{Tr}[\rho_A^n]) = \frac{1}{n} F(1) - \frac{1}{n} \log(\text{Tr}[\rho_A^n])$$

Rényi entropy \leftrightarrow free energy difference

$$S_A(n) = \frac{1}{1-n} \log(\text{Tr}[\rho_A^n]) = \frac{1}{n-1} (nF(n) - F(1))$$

HOW TO MEASURE ENTANGLEMENT ENTROPIES ?

at least in principle...

Experimental measurement of entanglement ?

- Few q-bits → measure sufficiently many correlations/observables in order to **reconstruct the complete density matrix** (quantum state tomography)
- Examples: nuclear spins $I=1/2$ or photon polarizations (H/V):

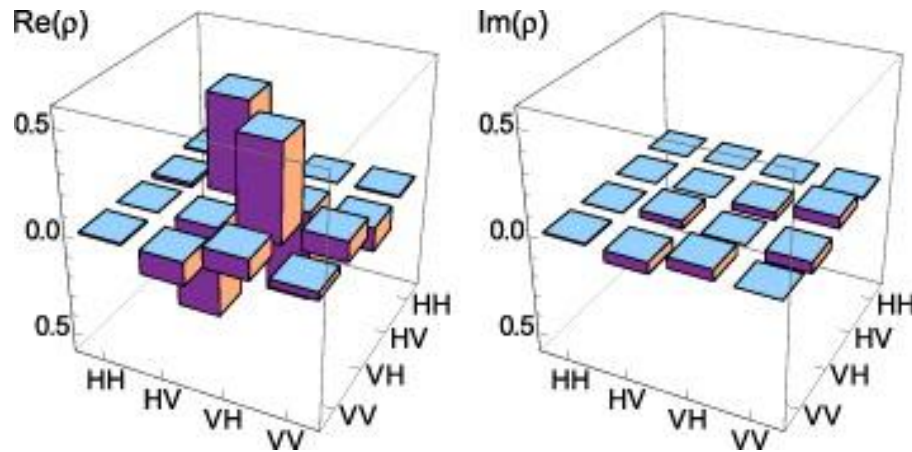

“Photon entanglement detection by a single atom”
J. Huwer et al 2013 [New J. Phys. 15 025033](#)

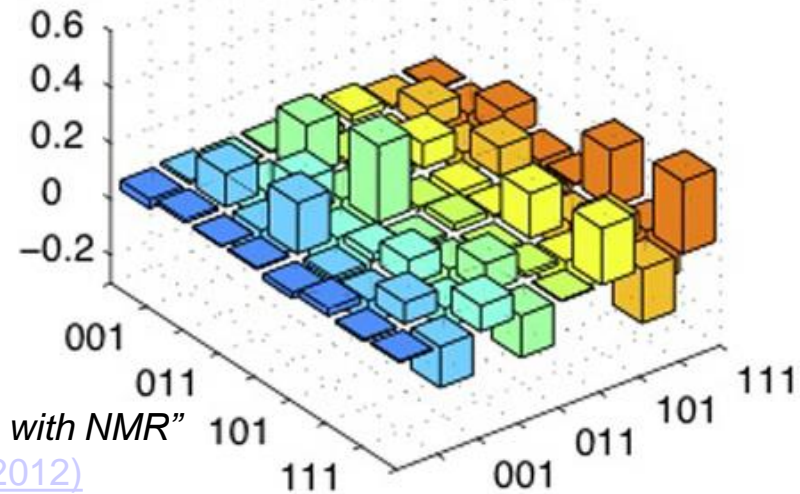

“Solving Quantum Ground-State Problems with NMR”
Zhaokai Li et al., [Scientific Reports 1, 88 \(2012\)](#)

- What about the entanglement entropy of a large system ?

Measurement of entanglement entropies ? (1)

- A few proposals based on coupling n copies of the system to measure the entropy S_n
- Example : “*Measuring Entanglement Entropy of a Generic Many-Body System with a Quantum Switch*” D. A. Abanin & E. Demler, [Phys. Rev. Lett. 109, 020504 \(2012\)](https://arxiv.org/abs/1205.4053)
We describe here the simplest case, with $n = 2$.

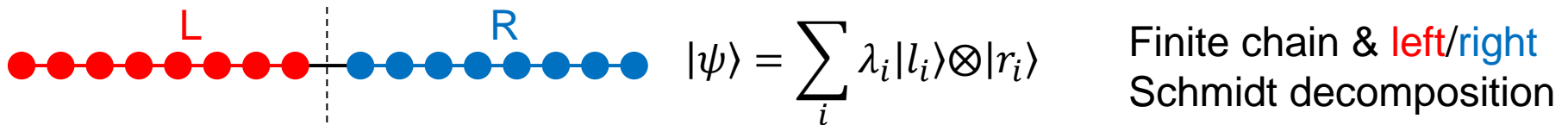

- Goal: “measure” the Rényi entropy $S_{n=2}$, that is $-\log \text{Tr}_R[\rho_L^2] = -\log[\sum_i (\lambda_i)^4]$
- 4 half-chains, that can be connected in two different ways:

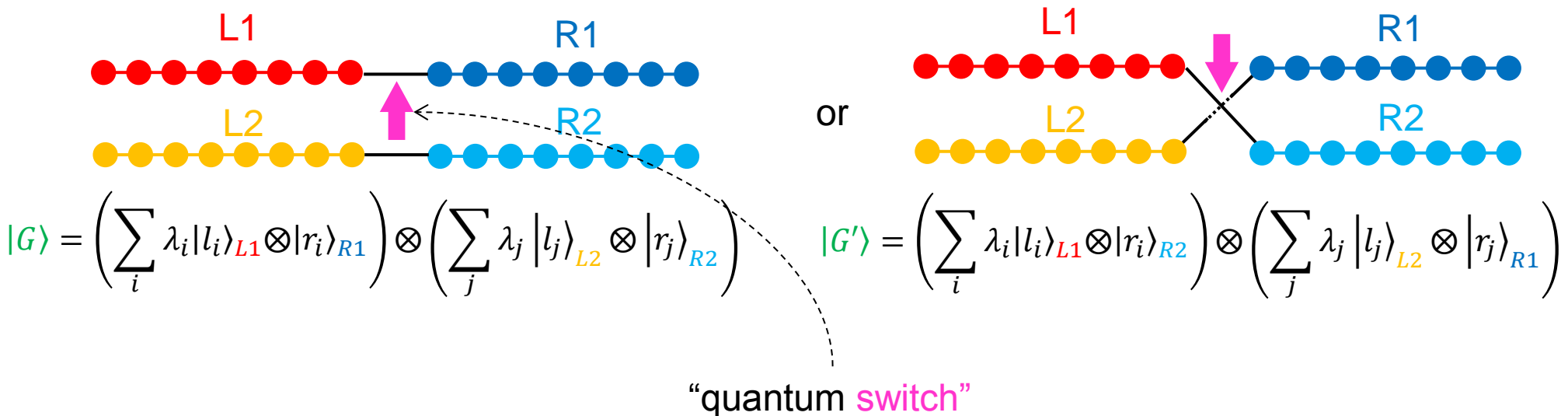

Measurement of entanglement entropies ? (2)

□ Rényi entropy S_n and scalar product

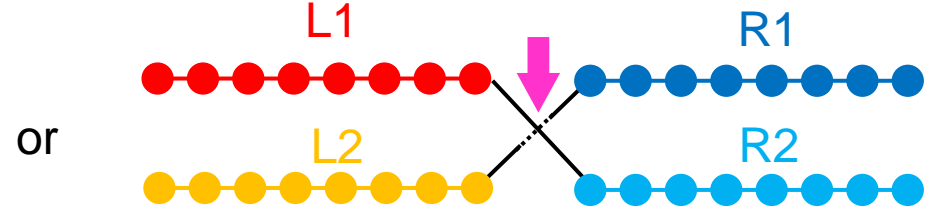
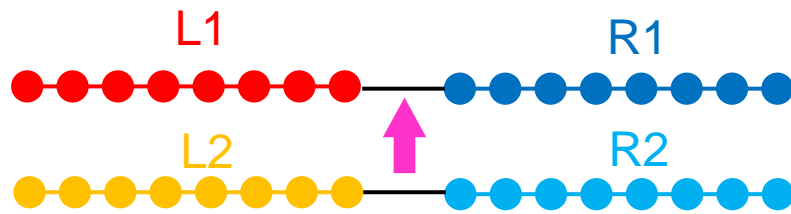

or

$$|G\rangle = \left(\sum_i \lambda_i |l_i\rangle_{L1} \otimes |r_i\rangle_{R1} \right) \otimes \left(\sum_j \lambda_j |l_j\rangle_{L2} \otimes |r_j\rangle_{R2} \right)$$

$$|G'\rangle = \left(\sum_k \lambda_k |l_k\rangle_{L1} \otimes |r_k\rangle_{R2} \right) \otimes \left(\sum_l \lambda_l |l_l\rangle_{L2} \otimes |r_l\rangle_{R1} \right)$$

$$\langle G|G'\rangle = \sum_{ijkl} \overline{\lambda_i} \lambda_j \lambda_k \lambda_l \delta_{ik} \delta_{il} \delta_{jl} \delta_{jk} = \sum_i |\lambda_i|^4 = \text{Tr}_R[\rho_L^2] = \exp(-S_2)$$

□ Introduce a weak transverse field on the central spin (quantum *switch*)

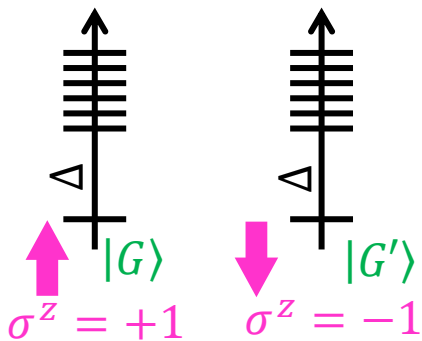

$+J\sigma^x$
 $\xrightarrow{\text{-----}}$
 Degenerate perturbation theory
 $(J \ll \Delta)$

$$H_{\text{eff}} = \begin{bmatrix} 0 & J\langle G|G'\rangle \\ J\langle G|G'\rangle & 0 \end{bmatrix}$$

Eigenvalues $\omega = \pm J\langle G|G'\rangle$

Measure the oscillation frequency ω of $\sigma^z(t) \rightarrow$ access to $\exp(-S_2)$
 generalization: couple n systems and a 2-state switch to measure S_n

Summary of lecture #1

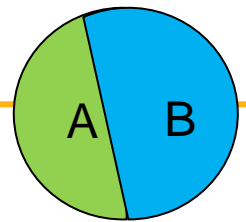

- Context: lattice quantum many-body problems (spin, fermions, ...)
- Two large subsystems in a pure state $|\psi\rangle \in \mathcal{H}_A \otimes \mathcal{H}_B$.
- The total density matrix $\rho_{AB} = |\psi\rangle\langle\psi|$ is a projector
- Reduced density matrix: $\rho_A = \text{Tr}_B[\rho_{AB}]$ $\text{Tr}_A[\rho_A] = \text{Tr}_{AB}[\rho_{AB}] = 1$
- Schmidt decomposition of $|\psi\rangle$:

$$|\psi\rangle = \sum_{ij} M_{ij} |a_i\rangle \otimes |b_j\rangle \Rightarrow \text{SVD of } M \Rightarrow \sum_k \lambda_k |u_k\rangle \otimes |v_k\rangle$$

- Spectrum of the RDM: $\rho_A = \sum_k |\lambda_k|^2 |u_k\rangle\langle u_k|$
- Von Neumann entropy

$$S_A = -\text{Tr}_B[\rho_A \log \rho_A] = -\sum_i |\lambda_k|^2 \log |\lambda_k|^2$$

- S_A quantifies the uncertainty on the state of A if we do not observe the region B .
- $S_A = 0 \Leftrightarrow \rho_A$ is a projector $\Leftrightarrow |\psi\rangle = |A\rangle \otimes |B\rangle$ is a product state
- Strong sub-additivity of the Von Neumann entropy: $S_{X \cup Y} + S_{X \cap Y} \leq S_X + S_Y$
- Useful generalization: Rényi entropies $S_A(n) = \frac{1}{1-n} \log(\text{Tr}[\rho_A^n])$
- $S_A(n)$ is often simpler to compute (and possibly to measure experimentally) than S_A when n is an integer ≥ 2 (replicas, etc.). n plays the role of an inverse temperature.
- Finite correlation length \rightarrow **area law** $S_A \sim \mathcal{O}(\text{Area of } \partial A) = \mathcal{O}(L^{d-1})$.

AREA/BOUNDARY LAW

for the entanglement entropy of low-energy states of short-ranged Hamiltonians. Decay of Schmidt eigenvalues.

Area law for the entanglement entropy

“Quantum source of entropy for black holes”

L. Bombelli, R. K. Koul, J. Lee, and R. D. Sorkin, [Phys. Rev. D 34, 373 \(1986\)](#)

«Entropy and area», M. Srednicki, [Phys. Rev. Lett. 71, 666 \(1993\)](#)

“Area Laws in Quantum Systems: Mutual Information and Correlations”

M. M. Wolf, F. Verstraete, M. B. Hastings, and J. I. Cirac, [Phys. Rev. Lett. 100, 070502 \(2008\)](#)

“Colloquium: Area laws for the entanglement entropy”

J. Eisert, M. Cramer, and M. B. Plenio, [Rev. Mod. Phys. 82, 277 \(2010\)](#)

- The ground-state (and low-energy excitations) of (many) Hamiltonians with short-ranged interactions have an entanglement entropy which scale like the area of the boundary of the subsystem

$$S_A \sim \mathcal{O}(\text{Area of } \partial A) = \mathcal{O}(L^{d-1})$$

- **Appears to be valid for all gapped systems (in $d = 1$ it's a theorem), and some gapless systems in $d > 1$ (not all).**
- Known gapless systems which violate the area law:
 - critical systems in $d = 1$
 - systems in $d > 1$ with a Fermi surface, where $S_A \sim \mathcal{O}(L^{d-1} \log L)$
- Can be proved in any dimension if we make a strong hypothesis on the decay of *all* correlations (Wolf *et al.* 2008), see a few slide below.

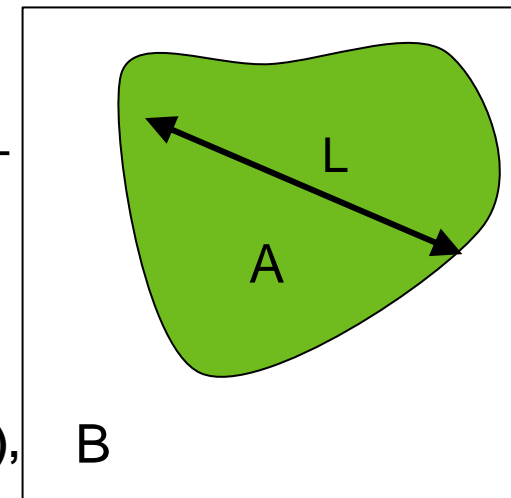

Area law for the entanglement entropy

- Simple (hand-waving!) argument
 - Pure state $|\psi\rangle$, ground state of some local Hamiltonian in spatial dimension d .
 - Assume that all connected correlation functions in $|\psi\rangle$ decay exponentially in space, with some finite correlation length ξ
 - Subsystem: some spatial region A of typical size $L \gg \xi$. (B =complement of A).
 - **Assume that the entanglement between A and B is entirely due to local correlations** (not a very precise statement...)
 - Correlations between degrees of freedom located *inside* A do not contribute to S_A . Same for correlations inside the region B .
 - The only contributions to the entanglement entropy S_A are those originating from correlations taking place across the boundary between A and B
 - Area/Boundary law for the entanglement entropy :
 $S_A \sim \text{size of } (\partial A) \sim L^{d-1}$

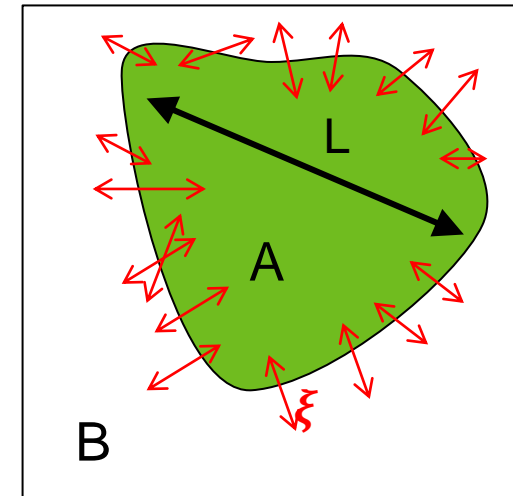

Area law for the entanglement entropy

- Variant of the intuitive argument ...

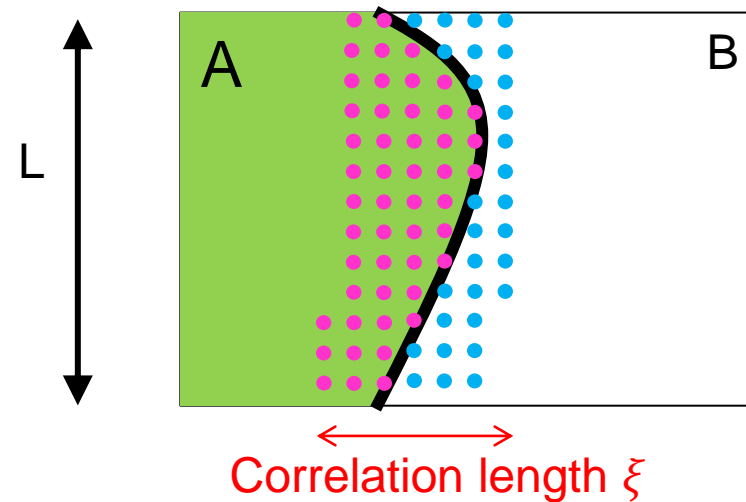

$i = 1 \dots \sim 2^{\xi L}$ configurations for the magenta sites ($\in A$)
 $j = 1 \dots \sim 2^{\xi L}$ configurations for the blue sites ($\in B$)

Assume the wave function can be approximated by :

$$|\psi\rangle \sim \sum_{i,j} M_{i,j} |\psi_i^A\rangle \otimes |\psi_j^B\rangle$$

Which means, that, once we project on a particular state (i,j) of the « boundary region » (of width $\sim \xi$), the regions A and B are no longer correlated (\rightarrow product state).

Schmidt decomposition (=SVD of M) \rightarrow number of non-zero values $\sim 2^{\xi L}$

$S_A \leq \xi L \log 2 \rightarrow$ boundary law

Remark about the area law & entanglement spectrum

- S_A = thermodynamic entropy of the entanglement spectrum $\{E_i\}$ (by definition)

Assume these $\{E_i\}$ are energies of some “fictitious system” associated to the bipartition A/B.

- Since $S_A \sim L^{d-1}$ can be interpreted as a “volume law” (as usual for thermodynamic entropy) for a system in $d - 1$ spatial dimension, the “fictitious system” probably lives at **the boundary between A & B**. We will see a few explicit examples later (“bulk-edge correspondence”)

Note: this is consistent with the fact that the spectrum of ρ_A (hence the $\{E_i\}$) is unchanged if we exchange A and B.

- If the number of Schmidt eigenvalues which contribute to entropy is a finite fraction of the dimension $\dim(H_A)$ (assume region B is much larger, for simplicity), we expect a volume-law behavior. If, instead, $S_A \sim L^{d-1}$, then we expect that most of the eigenvalues of ρ_A are much smaller than $1/\dim(H_A)$.

Mutual information

- Definition:

$$I(A:B) = S(\rho_A) + S(\rho_B) - S(\rho_{AB})$$

(with $S(\rho) = -\text{Tr}[\rho \log \rho]$).

- Alternatively: $I(A:B) = \text{Tr}[\rho_{AB}[\log(\rho_{AB}) - \log(\rho_A \otimes \rho_B)]]$

- Thanks to the sub-additivity of the Von Neumann entropy we have $I(A:B) \geq 0$.

A stronger result is: $I(A:B) \geq \frac{1}{2} \|\rho_{AB} - \rho_A \otimes \rho_B\|_1^2$ (=Pinsker inequality).

→ $I(A:B)$ can be viewed as some kind of “distance” between ρ_{AB} and $\rho_A \otimes \rho_B$. In particular: $I(A:B) = 0 \Leftrightarrow \rho_{AB} = \rho_A \otimes \rho_B$.

- $I(A:B)$ measures the total amount of correlations between A and B. Indeed, $I(A:B)$ can be shown (using the Pinsker inequality above → exercise !) to give a bound on correlators:

$$I(A:B) \geq \frac{(\langle O_A O_B \rangle - \langle O_A \rangle \langle O_B \rangle)^2}{2 \|O_A\|_1^2 \|O_B\|_1^2}$$

- $I(A:B) = 0$ then all correlations between A and B must vanish. If $I(A:B)$ decays exponentially with their distance, it will be also the case for any correlation between A and B.
- Remark 1: if AB is in a pure state ($\rho_{AB} = |\psi\rangle\langle\psi|$) we have $S(\rho_{AB}) = 0$. So: $I(A:B) = 2S(\rho_A) = 2S(\rho_B)$ is equivalent to the Von Neumann entropy.
- Remark 2: the “volume” contributions to the entropy cancel out in $I(A:B)$. → An area law is expected (see next slide)

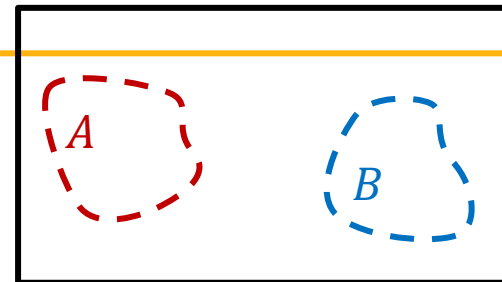

Mutual information & boundary law at $T > 0$

“Area Laws in Quantum Systems: Mutual Information and Correlations”, M. M. Wolf, F. Verstraete, M. B. Hastings, and J. I. Cirac, [Phys. Rev. Lett. 100, 070502 \(2008\)](#)

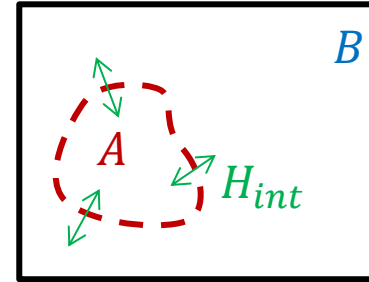

Free energy $F[\rho] = U - TS = \text{Tr}[H\rho] - \frac{1}{\beta} S(\rho)$ is minimized by $\rho_{AB} \sim e^{-\beta H}$

with $H = H_A + H_B + H_{int}$. H_{int} contains all the terms which couple A and B .

In particular: $F[\rho] \leq F[\rho_A \otimes \rho_B]$. So:

$$\text{Tr}[H\rho] - \frac{1}{\beta} S(\rho) \leq \text{Tr}[(H_A + H_B + H_{int})(\rho_A \otimes \rho_B)] - \frac{1}{\beta} (S(\rho_A) + S(\rho_B))$$

$$\frac{I(A:B)}{\beta} \leq \text{Tr}[H_{int}(\rho_A \otimes \rho_B - \rho)] \sim \mathcal{O}(\text{Area})$$

This demonstrates an area law behavior for $I(A:B)$ at **finite temperature**.

Remark: no general theorem for the area law at $T = 0$ in $d > 1$, although it is verified by a large class of systems (notable exception: states with Fermi surface). See however the argument on next slide.

Area law at $T = 0$

“Area Laws in Quantum Systems: Mutual Information and Correlations”, M. M. Wolf, F. Verstraete, M. B. Hastings, and J. I. Cirac, [Phys. Rev. Lett. 100, 070502 \(2008\)](#)

- Geometry: A and B are separated by some distance L . The “shell” in between is the region C . Define $I_L = I(A:B)$ = mutual information
- Using strong subadditivity one can show that I_L is a decreasing function of L (exercise!). **Define the correlation length ξ as the minimal distance which insures $I_L \leq \frac{I_0}{2}$ for all R .**
- Remarks:
 - This correlation length incorporates all types of correlations between A and the rest of the system.
 - It may be infinite in some cases. From now we assume it is finite, and take $L = \xi$.

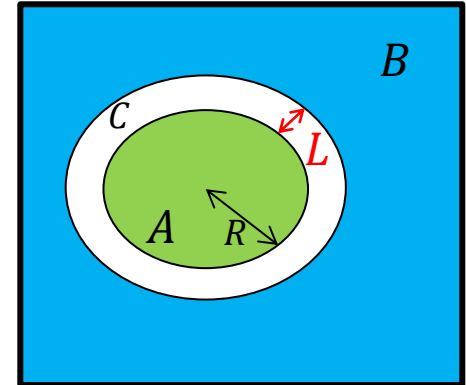

- Use sub-additivity and the Araki-Lieb triangular inequality to show (exercise!):

$$I(A:BC) \leq I(A:B) + 2S_C$$

- By construction $I(A:BC) = I_0$ and $I(A:B) = I_L$. By def. of ξ we have $I_L \leq \frac{I_0}{2}$, so: $I_0 \leq I_L + 2S_C \leq \frac{I_0}{2} + 2S_C$. Hence $I_0 \leq 4S_C$. Since S_C is bounded by its volume $|C| \sim \xi|\partial A|$. We get $I_0 \leq 4\xi|\partial A|$. Now if the entire system ABC in a pure state (no necessary so far) we have $I(A:BC) = I_0 = 2S_A$ and finally:

$$S_A \leq 2\xi|\partial A|$$

An area law for one-dimensional quantum systems

M B Hastings

Center for Nonlinear Studies and Theoretical Division, Los Alamos National Laboratory, Los Alamos, NM87545, USA
E-mail: hastings@lanl.gov

Received 16 May 2007

Accepted 27 July 2007

Published 20 August 2007

Online at stacks.iop.org/JSTAT/2007/P08024

doi:[10.1088/1742-5468/2007/08/P08024](https://doi.org/10.1088/1742-5468/2007/08/P08024)

Abstract. We prove an area law for the entanglement entropy in gapped one-dimensional quantum systems. The bound on the entropy grows surprisingly rapidly with the correlation length; we discuss this in terms of properties of quantum expanders and present a conjecture on matrix product states which may provide an alternate way of arriving at an area law. We also show that, for gapped, local systems, the bound on Von Neumann entropy implies a bound on Rényi entropy for sufficiently large $\alpha < 1$ and implies the ability to approximate the ground state by a matrix product state.

Keywords: rigorous results in statistical mechanics, entanglement in extended quantum systems (theory)

ArXiv ePrint: [0705.2024](https://arxiv.org/abs/0705.2024)

Universal violations & corrections to the area law

A few examples (non-exhaustive list)

- Violation (multiplicative log: $\sim L^{d-1} \log L$)
 - Critical systems in $d = 1$
Holzhey-Larsen-Wilczek 1994, Vidal-Latorre-Rico-Kitaev 2003, Calabrese-Cardy 2004, ...
 - Fermi surface (Wolf 2006, Gioev & Klich 2006)

- Corrections (additive log: $\mathcal{O}(L^{d-1}) + \mathcal{O}(\log L)$)
 - Some critical systems in $d = 2$, with sharp-corners (Fradkin-Moore 2006)
 - Continuous sym. breaking (Nambu-Golstone modes)
Metlitsky-Grover 2011, Luitz-Platz-Alet-Laflorencie 2015

- Correction (constant terms: $\mathcal{O}(L^{d-1}) + \mathcal{O}(L^0)$)
 - Discrete spontaneous sym. breaking (\rightarrow contribution $S_0 = \log(\text{degeneracy})$)
 - Topological order in $d = 2$ (Kitaev-Preskill 2006, Levin-Wen 2006)
 - Some (Lorentz-invariant) critical systems in $d = 2$ (Casini-Huerta 2007, + many others ...)
 - Some critical systems in $d = 2$ (Hsu *et al.* 2009, Stéphan-Furukawa-GM-Pasquier 2009)

Concerning critical systems, see the (very) recent work by B. Swingle & J. McGreevy, [arXiv:1505.07106](https://arxiv.org/abs/1505.07106)

VOLUME LAW

for high-energy states, relation between entanglement and thermal entropies

Comparison with random pure states

- “Average entropy of a subsystem”, D. Page, [Phys. Rev. Lett. \(1993\)](#)

$$\langle \dots \rangle = \langle \dots \rangle_{\text{whole Hilbert space } \mathcal{H}_A \otimes \mathcal{H}_B \text{ (Haar measure)}}$$

Assume $\dim[\mathcal{H}_A] \leq \dim[\mathcal{H}_B]$:

$$\langle S_A \rangle = \boxed{-\langle \text{Tr}(\rho_A \log \rho_A) \rangle = \log(\dim[\mathcal{H}_A]) - \frac{\dim[\mathcal{H}_A]}{2\dim[\mathcal{H}_B]}} \sim \mathcal{O}(L^d) = \textbf{Volume law}$$

- For the full probability distribution of S_A , see C. Nadal, S. N. Majumdar, and M. Vergassola, [Phys Rev Lett 104, 110501 \(2010\)](#) (random matrix model methods)

→ The probability distribution is highly peaked around the average value (variance $\text{Var}(S_A) \sim \mathcal{O}(\dim[\mathcal{H}_A]^{-2})$) and the scaling of the **typical** entropy is a also a volume law.

→ States satisfying an area law are rare

- Choose a subsystem A such that $1 \ll \dim[\mathcal{H}_A] = m \leq \dim[\mathcal{H}_B] = n$.

1. Pick a pure state at random in $\mathcal{H}_A \otimes \mathcal{H}_B$, and you will find $S_A \sim \log m - \frac{m}{2n}$.

2. Now consider the infinite-temperature density matrix for the region A :

$$\rho_A^{T=\infty} = \frac{\text{Id}_m}{m}. \text{ It gives } S_A^{T=\infty} = \log m.$$

3. Conclusion: when the region B is large (i.e. $\frac{m}{n} \ll 1$) you can hardly distinguish the two situations.

ETH, entanglement entropy & thermal entropy (1)

- Hamiltonian $H = \sum_{\alpha} E_{\alpha} |\alpha\rangle\langle\alpha|$
- The initial state is a linear combination of eigenstates which lie in a small energy windows $[E - \Delta E, E + \Delta E]$ (E is extensive (above the ground state) whereas $\Delta E \sim \mathcal{O}(1)$):

$$|\psi\rangle = \sum_{\alpha} c_{\alpha} |\alpha\rangle$$

- Time evolution:

$$|\psi(t)\rangle = \sum_{\alpha} c_{\alpha} e^{-iE_{\alpha}t} |\alpha\rangle$$

- Expectation value of some observable A :

$$\langle\psi(t)|A|\psi(t)\rangle = \sum_{\alpha} |c_{\alpha}|^2 A_{\alpha\alpha} + \sum_{\alpha \neq \beta} A_{\alpha\beta} \bar{c}_{\alpha} c_{\beta} e^{-i(E_{\beta} - E_{\alpha})t}$$

- Long-time average (assume no degeneracy):

$$\frac{1}{\tau} \int_0^{\tau} \langle\psi(t)|A|\psi(t)\rangle dt = \sum_{\alpha} |c_{\alpha}|^2 A_{\alpha\alpha} + i \sum_{\alpha \neq \beta} A_{\alpha\beta} \bar{c}_{\alpha} c_{\beta} \left(\frac{e^{-i(E_{\beta} - E_{\alpha})\tau} - 1}{\tau} \right)$$

$$\bar{A} = \lim_{\tau \rightarrow \infty} \frac{1}{\tau} \int_0^{\tau} \langle\psi(t)|A|\psi(t)\rangle dt = \sum_{\alpha} |c_{\alpha}|^2 A_{\alpha\alpha}$$

- If $\langle\psi(t)|A|\psi(t)\rangle$ relaxes to some limit at long times, the long time limit must coincide with \bar{A} . This corresponds to the so-called **diagonal ensemble**:

$$\rho_{\text{diag}}[c_{\alpha}] = \sum_{\alpha} |c_{\alpha}|^2 |\alpha\rangle\langle\alpha|$$

ETH, entanglement entropy & thermal entropy (2)

- Assumption: **the observable A “thermalizes”**, which means that $\langle \psi(t) | A | \psi(t) \rangle$ converges to the prediction of some thermodynamical ensemble (hence independent of the details of the initial state, except for the energy E_0), here the micro-canonical one:

$$\sum_{\alpha} |c_{\alpha}|^2 A_{\alpha\alpha} = \text{Tr}[\rho_{\text{diag}}[c_{\alpha}]A] = \text{Tr}[\rho_{\text{micro}}(E)A] = \frac{1}{\mathcal{N}(E, \Delta E)} \sum_{\alpha} A_{\alpha\alpha}$$

$$\rho_{\text{micro}}(E) = \frac{1}{\mathcal{N}(E, \Delta E)} \sum_{\substack{\alpha \\ |E_{\alpha} - E| < \Delta E}} |\alpha\rangle\langle\alpha|$$

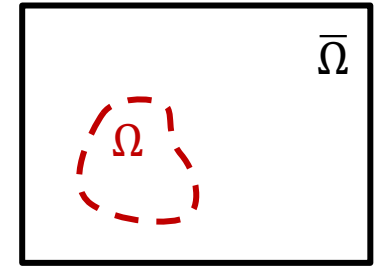

- Remark: $\rho_{\text{diag}}[c_{\alpha}]$ depends on the initial conditions, but $\rho_{\text{micro}}(E)$ does not...How can that be ?
- A possible/plausible explanation: **“Eigenstate thermalization Hypothesis (ETH)”** :
 - the diagonal matrix elements $A_{\alpha\alpha}$ are (in thermodynamic limit) smooth functions of the energy density, and independent of the choice of the eigenstate (in a sufficiently narrow energy window). Hence $\bar{A} = \langle A \rangle_{\text{micro}}(E)$.
 - Off diagonal elements $A_{\alpha\beta}$ ($\alpha \neq \beta$) vanish (in the thermodynamic limit)

References on ETH:

- [1] J. M. Deutsch “*Quantum statistical mechanics in a closed system*”, [Phys. Rev. A 43, 2046 \(1991\)](#)
- [2] M. Srednicki “*Chaos and quantum thermalization*”, [Phys. Rev. E 50, 888 \(1994\)](#)
- [3] M. Rigol, V. Dunjko, Vanja & M. Olshanii “*Thermalization and its mechanism for generic isolated quantum systems*”, [Nature 452 854 \(2008\)](#)

ETH, entanglement entropy & thermal entropy (3)

J. R. Garrison & T. Grover [arXiv:1503.00729](https://arxiv.org/abs/1503.00729)

$$1 \ll \text{vol}(\Omega) \ll \text{vol}(\bar{\Omega})$$

- Strong form of ETH: **all the observables in Ω satisfy the ETH**

Consequences:

- the RDM computed in some arbitrary eigenstate $|\alpha\rangle$ at energy $E_\alpha \sim E$ becomes “thermal” in the thermodynamic limit:
 $\rho_\Omega(|\alpha\rangle) = \text{Tr}_{\bar{\Omega}}[|\alpha\rangle\langle\alpha|] \sim \text{Tr}_{\bar{\Omega}}[\rho_{micro}(E)]$ (with $E_\alpha \sim E$)
- the Von Neumann/entanglement entropy of an excited eigenstate is (asymptotically) the thermodynamic entropy of the subsystem
- The volume law for the thermodynamic entropy at $T > 0$ implies a volume law for the Von Neumann entropy of high-energy eigenstates.

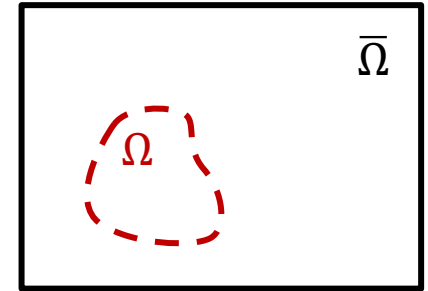

- Assume further that the thermodynamic free energy density $f(\beta)$ can equivalently be obtained from $\rho_{micro}^\Omega(E) = \text{Tr}_{\bar{\Omega}}[\rho_{micro}(E)]$ or $\rho_{cano} \sim \frac{\exp(-\beta H_\Omega)}{Z(\beta)}$ (adjust the inverse temperature β to match the energy E), which describe this region Ω , isolated, and at thermal equilibrium. Then :

$$\begin{aligned} \text{vol}(\Omega)f(n\beta) &= -\frac{1}{n\beta} \log \text{Tr}[\exp(-\beta H_\Omega)^n] \sim -\frac{1}{n\beta} \log \text{Tr} \left[Z(\beta)^n \left(\rho_{micro}^\Omega(E) \right)^n \right] \\ &\sim -\frac{1}{\beta} \log Z(\beta) - \frac{1}{n\beta} \log \text{Tr}[\rho_\Omega(|\alpha\rangle)^n] = -\frac{1}{\beta} \log Z(\beta) - \frac{1-n}{n\beta} S_{\text{Rényi}}^n(|\alpha\rangle) \end{aligned}$$

Finally: $f(n\beta) - f(\beta) = \frac{n-1}{n\beta \text{vol}(\Omega)} S_{\text{Rényi}}^n(|\alpha\rangle)$ The Rényi entanglement entropies of a single eigenstate gives the thermodynamic free energy at all temperatures !

FREE PARTICLES

Computing & diagonalizing reduced density matrices in free fermion/boson problems

Free particles & Peschel's trick (1)

I Peschel and M.-C. Chung, [J. Phys. A: Math. Gen. 32 8419 \(1999\)](#)

I. Peschel, [J. Phys. A: Math. Gen. 36 L205 \(2003\)](#)

□ Free fermions or free bosons on a lattice

Most general (lattice) quadratic Hamiltonian: $H_0 = \sum_{i,j} A_{i,j} c_i^\dagger c_j + \sum_{i,j} B_{i,j} c_i^\dagger c_j^\dagger + H.c.$

H_0 can be diagonalized using a Bogoliubov transformation (see next slides), and the $T = 0$ (as well as $T > 0$) correlations can be calculated easily.

□ $\langle c_i^\dagger c_j \rangle \rightarrow$ Wick theorem \rightarrow any correlator

$C_{ij} = \langle c_i^\dagger c_j \rangle_{i,j \in A} \rightarrow$ any observable in region $A \rightarrow \rho_A$

The reduced density ρ_A is completely determined by two-point functions in the region of interest

□ Correlators in region A obeys Wick's theorem $\rightarrow \rho_A$ is Gaussian

$\rightarrow \exists$ quadratic « Hamiltonian » H such that $\rho_A = \frac{1}{Z} \exp(-H)$

with $H = \sum_{i,j} h_{i,j} c_i^\dagger c_j + \sum_{i,j} \Delta_{i,j} c_i^\dagger c_j^\dagger + H.c.$

Remark: H depends on the subsystem A (should be noted $H_A \dots$), it is *not* the physical Hamiltonian H_0 .

\rightarrow The entanglement entropy $S_A = -\text{Tr}[\rho_A \log \rho_A]$ is the thermodynamic entropy of H at (fictitious) temperature 1.

Free particles & Peschel's trick (2)

Correlation matrix

$$C = \begin{bmatrix} \langle c_i^\dagger c_j \rangle & \langle c_i^\dagger c_j^\dagger \rangle \\ \langle c_i c_j \rangle & \langle c_i c_j^\dagger \rangle \end{bmatrix} = \left\langle \begin{bmatrix} c^\dagger \\ c \end{bmatrix} [c \quad c^\dagger] \right\rangle \text{ dim. } 2N \times 2N, C = \begin{bmatrix} A & D \\ D^\dagger & 1 \pm A^t \end{bmatrix}, D_{ij} = \langle c_i^\dagger c_j^\dagger \rangle, A_{ij} = \langle c_i^\dagger c_j \rangle$$

We look for new creation/annihilation operators a, a^\dagger (=Bogoliubov transformation):

$$\begin{bmatrix} a^\dagger \\ a \end{bmatrix} = U \begin{bmatrix} c^\dagger \\ c \end{bmatrix} \text{ with } U \begin{bmatrix} \mp 1 & 0 \\ 0 & 1 \end{bmatrix} U^\dagger = \begin{bmatrix} \mp 1 & 0 \\ 0 & 1 \end{bmatrix} = \Sigma \text{ Upper sign for boson, lower sign for fermions}$$

Such that the correlations of the new “particles” are diagonal :

$$\begin{bmatrix} \langle a_k^\dagger a_{k'} \rangle & \langle a_k^\dagger a_{k'}^\dagger \rangle \\ \langle a_k a_{k'} \rangle & \langle a_k a_{k'}^\dagger \rangle \end{bmatrix} \begin{bmatrix} \lambda_k \delta_{k,k'} & 0 \\ 0 & (1 \pm \lambda_k) \delta_{k,k'} \end{bmatrix} = \Lambda = UCU^\dagger$$

So, the linear algebra problem we have to solve is $\begin{cases} UCU^\dagger = \Lambda \\ U\Sigma U^\dagger = \Sigma \end{cases}$

One method is to diagonalize the matrix $C\Sigma = \begin{bmatrix} \mp \langle c_i^\dagger c_j \rangle & \langle c_i^\dagger c_j^\dagger \rangle \\ \mp \langle c_j c_j \rangle & \langle c_i c_j^\dagger \rangle \end{bmatrix}$. Indeed, combining the

equations above we get $UC\Sigma U^{-1} = \Lambda\Sigma$. By construction, the correlations of the new particles are very simple: $\langle a_k^\dagger a_{k'} \rangle = \delta_{k,k'} \lambda_k$ and $\langle a_k a_{k'} \rangle = \langle a_k^\dagger a_{k'}^\dagger \rangle = 0$. We have found some independent “correlation modes”.

Free particles & Peschel's trick (3)

$$\square C = \begin{bmatrix} \langle c_i^\dagger c_j \rangle & \langle c_i^\dagger c_j^\dagger \rangle \\ \langle c_j c_j \rangle & \langle c_i c_j^\dagger \rangle \end{bmatrix} = \begin{bmatrix} A & D \\ D^\dagger & 1 \pm A^t \end{bmatrix}$$

- Exercise: When A and D are real, show that the following (smaller: $N \times N$) diagonalization gives the eigenvalues λ :

$$\text{Eigenvalues of } \left(A \pm \frac{1}{2} + D \right) \left(A \pm \frac{1}{2} - D \right) = \left\{ \left(\lambda_k \pm \frac{1}{2} \right)^2 \right\}$$

cf. Lieb, Schultz & Mattis, [*Ann. Phys., NY* **16** 407 \(1961\)](#)

Free particles & Peschel's trick (4)

Recall: $\langle a_k^\dagger a_{k'} \rangle = \delta_{k,k'} \lambda_k$ & $\langle a_k a_{k'} \rangle = \langle a_k^\dagger a_{k'}^\dagger \rangle = 0$

- Question: what is the (quadratic) “Hamiltonian” H such that the correlations above can be obtained through some “thermal” average: $\langle \dots \rangle = \frac{1}{Z} \text{Tr}[(\dots) e^{-H}]$?
- Answer: Since the modes are uncorrelated, H must be diagonal in terms of the a and a^\dagger and take the form $H = \sum_k \epsilon_k a_k^\dagger a_k$. One then has to adjust the « pseudo energies » ϵ_k so that $\langle a_k^\dagger a_k \rangle = \lambda_k$:

$$\langle a_k^\dagger a_k \rangle = \lambda_k = \begin{cases} \frac{1}{e^{\epsilon_k} - 1} & \text{bosons} \\ \frac{1}{e^{\epsilon_k} + 1} & \text{fermions} \end{cases} \Rightarrow \epsilon_k = \log \left(\frac{1 \pm \lambda_k}{\lambda_k} \right)$$

- Which finally gives the RDM:

$$\rho_A \sim \exp \left(- \sum_k \log \left(\frac{1 \pm \lambda_k}{\lambda_k} \right) a_k^\dagger a_k \right)$$

- And the (entanglement) entropy is given by the sum of the contributions of each mode:

$$S = \sum_k S(\epsilon_k) \text{ with } S(\epsilon) = \begin{cases} -\log(1 - e^{-\epsilon}) + \frac{\epsilon}{e^\epsilon - 1} & \text{bosons} \\ +\log(1 + e^{-\epsilon}) + \frac{\epsilon}{e^\epsilon + 1} & \text{fermions} \end{cases}$$

$$= -\lambda \log(\lambda) - (1 - \lambda) \log(1 - \lambda)$$

- Remark: For fermions, the eigenvalues $\lambda = 0$ or 1 do not contribute to the entropy ($\epsilon = \pm\infty$). For bosons, $\lambda = 0$ do not contribute.

Entanglement entropy after a local “quench”

Example of an application of Peschel’s trick to compute the entanglement in a time-dependent situation

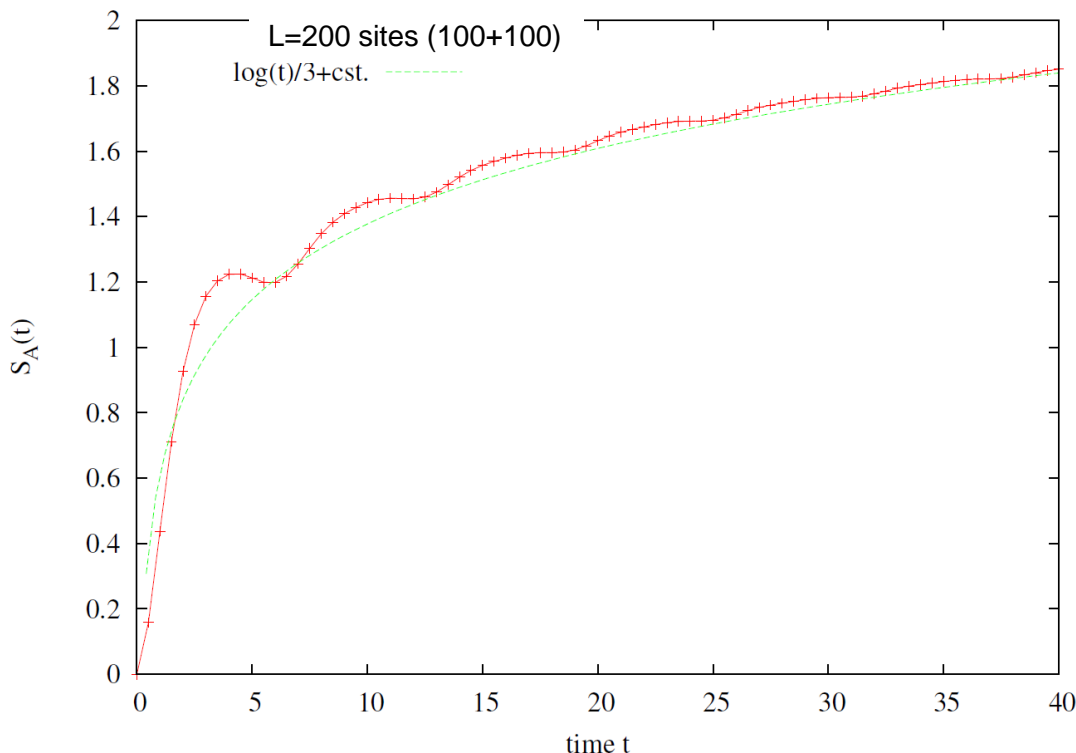

Initial (product) state $|\psi_0\rangle = |a\rangle \otimes |b\rangle$



H_A and H_B : free fermions ($= \sum_i c_i^\dagger c_{i+1} + h.c.$)

$|a\rangle = \text{g.s. of } H_A$

$|b\rangle = \text{g.s. of } H_B$

Unitary evolution to $t > 0$:

$$|\psi(t)\rangle = \exp(-itH) |\psi_0\rangle$$

$$H = H_A + H_B + H_{int}$$

H_{int} : hopping between the A & B

$\rho_A(t) = \text{Tr}_B[|\psi(t)\rangle\langle\psi(t)|]$ remains “Gaussian”

$S_A(t) = -\text{Tr}_B[\rho_A(t) \log \rho_A(t)]$ can be computed with Peschel’s trick, using the (time-dependent) 2-point correlations.

Remark: we observe a logarithmic growth of $S_A(t)$ (holds as long as $t \lesssim L/2$)

Free fermions on a chain – correlation matrix

- Ground-state on a periodic chain

$$H = -\frac{1}{2} \sum_n c_n^\dagger c_{n+1} + c_{n+1}^\dagger c_n = - \sum_k \cos(k) c_k^\dagger c_k$$

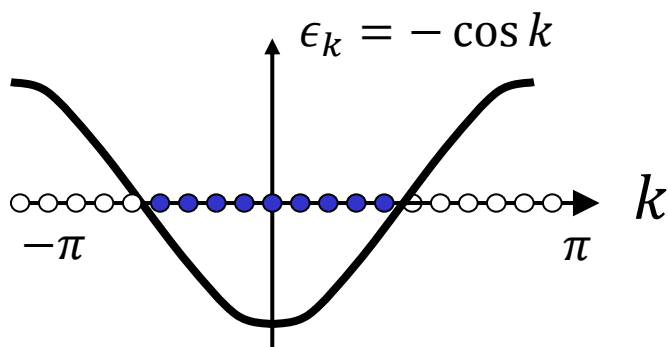

$$|\psi\rangle = \prod_{-k_F \leq k \leq k_F} c_k^\dagger |\text{vacuum}\rangle$$

$$c_k^\dagger = \frac{1}{\sqrt{L}} \sum_{n=0}^{L-1} e^{-ikn} c_n^\dagger$$

- Two-point correlations \rightarrow matrix $A_{n,m}$

$$\langle \psi | c_n^\dagger c_m | \psi \rangle = \sum_{-k_F \leq k \leq k_F} \langle 0 | c_k c_n^\dagger | 0 \rangle \langle 0 | c_m c_k^\dagger | 0 \rangle = \frac{1}{L} \sum_{-k_F \leq k \leq k_F} e^{ik(n-m)}$$

$$A_{n,m} = \lim_{L \rightarrow \infty} \langle \psi | c_n^\dagger c_m | \psi \rangle = \int_{-k_F}^{k_F} \frac{dk}{2\pi} e^{ik(n-m)} = \frac{\sin(k_F(n-m))}{\pi(n-m)}$$

Free fermions on a chain – determinant

Jin & Korepin, [J. Stat Phys. 116, 79 \(2004\)](#)

□ Recall:

$$\text{Correlation matrix: } A_{n,m} = \lim_{L \rightarrow \infty} \langle \psi | c_n^\dagger c_m | \psi \rangle = \int_{-k_F}^{k_F} \frac{dk}{2\pi} e^{ik(n-m)} = \frac{\sin(k_F(n-m))}{\pi(n-m)}$$

Entanglement entropy: $S = \sum_k S(\lambda_k)$ = sum over the eigenvalues of A
and $S(\lambda) = -\lambda \log(\lambda) - (1 - \lambda) \log(1 - \lambda)$

□ Equivalent formulation in terms of a **contour integral**, with poles at each eigenvalue:

$$\det[\lambda \mathbb{I} - A] = \prod_k (\lambda - \lambda_k)$$

$$\log \det[\lambda \mathbb{I} - A] = \sum_k \log(\lambda - \lambda_k)$$

$$\frac{d \log \det[\lambda \mathbb{I} - A]}{d\lambda} = \sum_k \frac{1}{\lambda - \lambda_k}$$

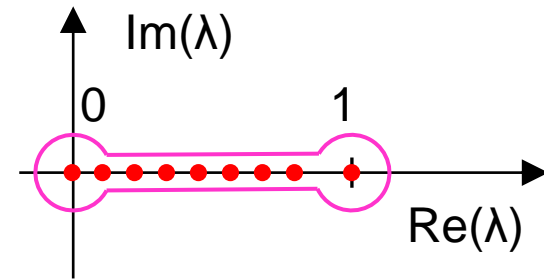

$$S = \sum_k S(\lambda_k) = \oint \frac{d\lambda}{2i\pi} S(\lambda) \frac{d \log \det[\lambda \mathbb{I} - A]}{d\lambda}$$

Fisher-Hartwig conjecture

Asymptotic behavior of the det. of Toeplitz matrices with singular symbol (simplified version...)

□ $A_{m,n} = A(m - n)$ parametrized as Fourier coefficients: $A(k) = \int_0^{2\pi} \frac{d\theta}{2\pi} \phi(\theta) e^{-ik\theta}$

ϕ is called the **symbol** of the Toeplitz matrix A .

Remark: in our (free fermion) case, the symbol ϕ of the correlation matrix A has two discontinuities (details in a few slides...)

□ Parametrize the symbol's discontinuities with some numbers (complex) β_r and (real) θ_r :

$$\phi(\theta) = \psi(\theta) \prod_{r=1}^R \exp(-i\beta_r * \arg(e^{i(\pi - \theta + \theta_r)})) \quad \text{with } \arg \in] - \pi, \pi]$$

$\psi(\theta)$: smooth, and no winding

→ pointwise singularity at each θ_r :

$$\frac{\phi(\theta = \theta_r + \epsilon)}{\phi(\theta = \theta_r - \epsilon)} = \frac{\exp(-i\beta_r * (\pi + \epsilon))}{\exp(-i\beta_r * (-\pi + \epsilon))} \rightarrow \exp(-2i\beta_r)$$
$$-2i\beta_r = \log\left(\frac{\phi(\theta_r + \epsilon)}{\phi(\theta_r - \epsilon)}\right)$$

□ The Fisher-Hartwig's conjecture describes the asymptotic behavior of the $\det[A]$:

$$\log \det[A] = L \int_0^{2\pi} \frac{d\theta}{2\pi} \log \phi(\theta) + \boxed{-\log(L) \sum_{r=1}^R (\beta_r)^2} + \dots$$

Fisher-Hartwig conjecture & 1d Fermi sea (1)

□ Recall: $A_{n,m} = \int_{-k_F}^{k_F} \frac{dk}{2\pi} e^{ik(n-m)} = \frac{\sin(k_F(n-m))}{\pi(n-m)} = \int_0^{2\pi} \frac{dk}{2\pi} \phi(\theta) e^{ik(n-m)}$

→ Symbol for $\lambda \mathbb{I} - A$: $\phi(\theta) = \begin{cases} \lambda - 1 & \text{if } \theta \in [-k_F, k_F] \\ \lambda & \text{otherwise} \end{cases}$

→ 2 discontinuities in $\theta = -k_F$ and $\theta = +k_F$:

$$\beta_1 = \frac{1}{2i\pi} \log\left(\frac{\lambda - 1}{\lambda}\right)$$

$$\beta_2 = \frac{1}{2i\pi} \log\left(\frac{\lambda}{\lambda - 1}\right) = -\beta_1$$

□ Use Fisher-Hartwig:

$$\log(\det[\lambda - A]) = \frac{1}{2\pi} (2k_F \log(\lambda - 1) + 2(\pi - k_F))L - 2(\beta_1)^2 \log(L) + \dots$$

$$\frac{d \log(\det[\lambda - A])}{d\lambda} = \frac{1}{2\pi} \left(\frac{2k_F}{\lambda - 1} + \frac{2(\pi - k_F)}{\lambda} \right) L - 4\beta_1 \frac{d\beta_1}{d\lambda} \log(L) + \dots$$

$$\frac{d\beta_1}{d\lambda} = \frac{1}{2i\pi(\lambda(\lambda - 1))}$$

$$\sum_k \frac{1}{\lambda - \lambda_k} = \frac{d \log(\det[\lambda - A])}{d\lambda} = \underbrace{\frac{1}{2\pi} \left(\frac{2k_F}{\lambda - 1} + \frac{2(\pi - k_F)}{\lambda} \right) L}_{\sim L} - 4 \frac{1}{(2i\pi)^2} \log\left(\frac{\lambda - 1}{\lambda}\right) \frac{1}{\lambda(\lambda - 1)} \log(L) + \dots$$

Remark: 2 poles in $\lambda = 0$ and $\lambda = 1$ with extensive residues ($\sim L$)

Physical meaning: an extensive number of single-particle “states” of the segment are either completely filled ($\lambda_k = \langle a_k^\dagger a_k \rangle = 1$) or completely empty ($\lambda_k = \langle a_k^\dagger a_k \rangle = 0$) and do not contribute to the entanglement.

Fisher-Hartwig conjecture & 1d Fermi sea (2)

$$\frac{d\log(\det[\lambda - A])}{d\lambda} = \frac{1}{2\pi} \left(\frac{2k_F}{\lambda - 1} + \frac{2(\pi - k_F)}{\lambda} \right) L - 4 \frac{1}{(2i\pi)^2} \log\left(\frac{\lambda - 1}{\lambda}\right) \frac{1}{\lambda(\lambda - 1)} \log(L) + \dots$$

$$S = \oint \frac{d\lambda}{2i\pi} [-\lambda \log(\lambda) - (1 - \lambda) \log(1 - \lambda)] \frac{d\log(\det[\lambda - A])}{d\lambda}$$

□ The only contribution to this **contour integral** is the discontinuity of $\log(\lambda - 1)$ on the real axis:

$$\log(\lambda - 1 + i0^-) - \log(\lambda - 1 + i0^+) = -2i\pi$$

$$S = 0 \times L - 4 \frac{-2i\pi}{(2i\pi)^3} \log(L) \underbrace{\int_0^1 d\lambda \frac{-\lambda \log(\lambda) - (1 - \lambda) \log(1 - \lambda)}{\lambda(\lambda - 1)}}_{= -\frac{\pi^2}{3}}$$

$$S = +\frac{1}{3} \log(L) + \dots$$

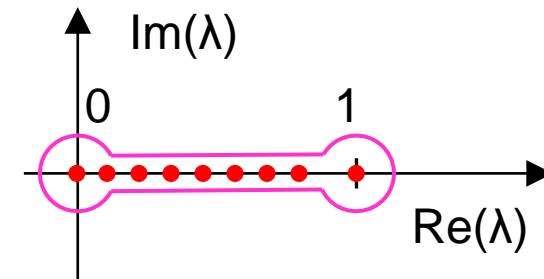

NB: the poles in 0 and 1 do not contribute since the residue vanishes → no $\mathcal{O}(L)$ (“volume”) term

Origin of the $\log(L)$ term: discontinuity of the symbol ← discontinuity of the fermion occupation number in Fourier space ← algebraic decay of the correlations

Entanglement in a free fermion chain & $S \sim \log(L)/3$

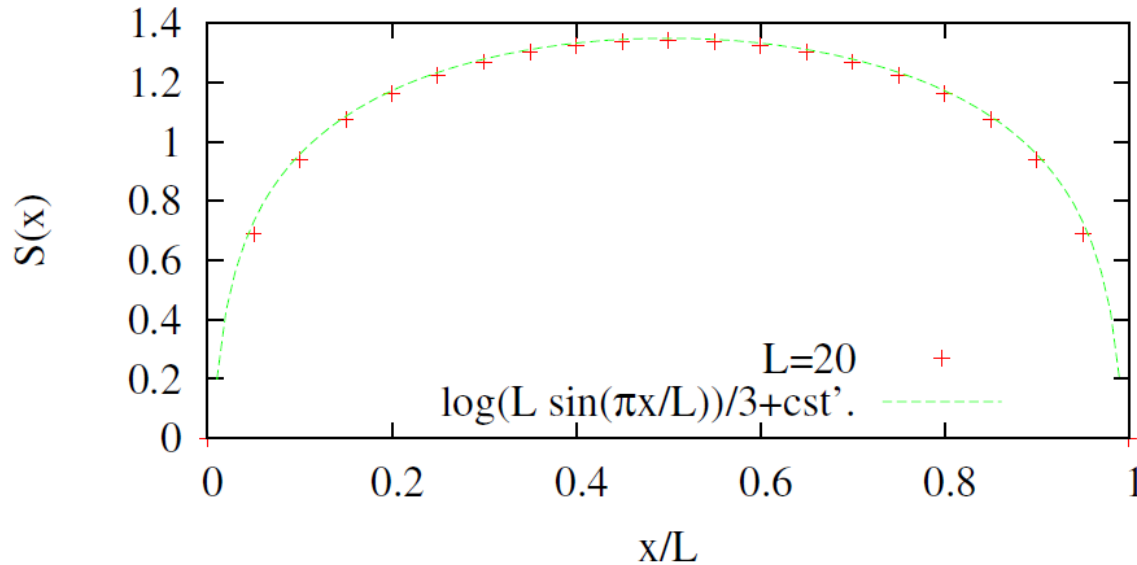
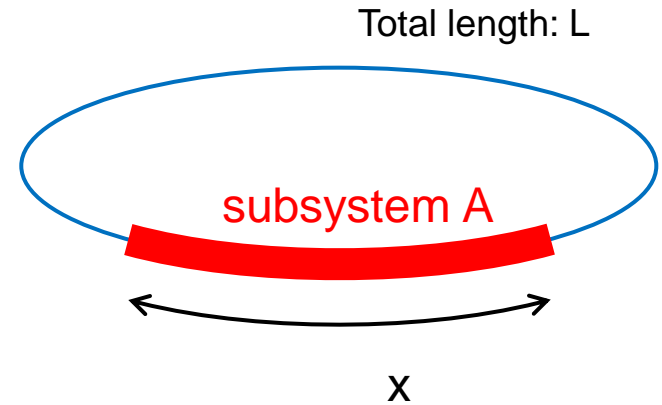
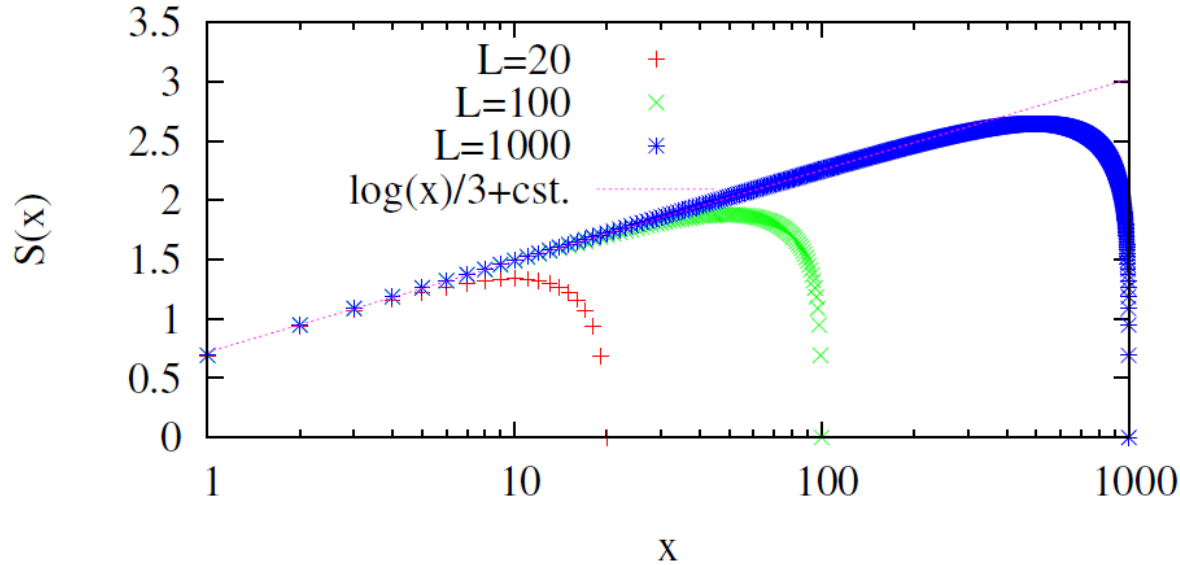

Same data (red dots), compared with the log of the “chord” distance (green curve) :

$$d(x) = 2L \sin\left(\frac{\pi x}{L}\right)$$

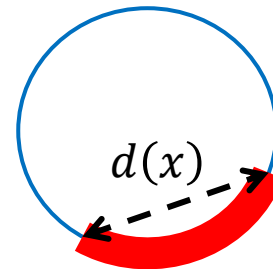

Summary of lecture #2

- ❑ Mutual information $I(A: B) = S(\rho_A) + S(\rho_B) - S(\rho_{AB})$.
Encodes *all* the correlations (quantum or classical) between the regions A and B .
- ❑ Using $I(A: B)$ one can define an “all-correlations” length ξ . If it is finite, the system obeys an area law for the entanglement entropy (argument by Wolf *et al*, [PRL 2008](#))
- ❑ Random pure states have a large entanglement entropy (volume law, and close to the maximal possible value $\log(\dim[\mathcal{H}_A])$)
- ❑ Relations between thermodynamics, the eigenstate thermalization hypothesis (ETH) and the entanglement in highly excited pure states: $S_{\text{thermo}}^A(E) = S_{\text{VonNeumann}}^A(|\alpha\rangle)$
- ❑ Free particle systems (fermions or bosons): Reduced density matrices are Gaussian and fully determined by the 2-point correlation functions (Wick’s theorem). The Von Neumann entropy is a simple function of the eigenvalues of the correlation matrix.
- ❑ Application to the calculation of the entropy of a segment in a free Fermion chains (Jin & Korepin [2004](#)):
 - Map $S_{\text{VonNeumann}}^A$ to a contour integral of a determinant. Toeplitz matrix with a discontinuous “symbol” (\leftrightarrow discontinuity of the fermion occupation number at the Fermi points)
 - Fisher-Hartwig \rightarrow asymptotics of the determinant has a $\log(L)$ term.
 - $S(L) = \frac{1}{3} \log(L)$. Universal coefficient (only depends on the number of Fermi points, not on the details of the dispersion relation nor the density).

Entanglement in free fermion chain: gap versus gapless

Dimerized free-fermion chain (2-site unit cell):

$$H = -t \sum_n (c_{2n}^\dagger c_{2n+1} + c_{2n+1}^\dagger c_{2n}) - t' \sum_n (c_{2n+1}^\dagger c_{2n+2} + c_{2n+2}^\dagger c_{2n+1})$$

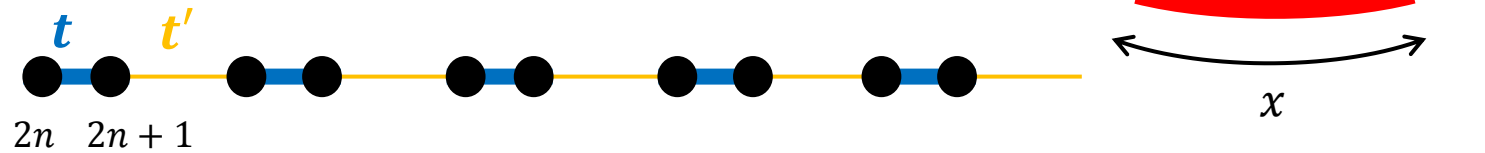

Band structure

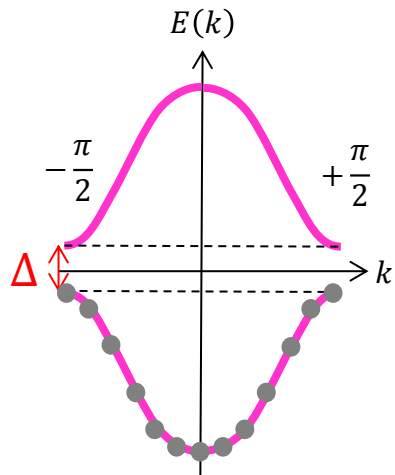

$$E(k) = \pm \sqrt{(t - t')^2 + 4tt' \cos(k)^2}$$

gap $\Delta = 2|t - t'|$ when the chemical potential is at $E = 0$
 → band insulator at half-filling if $t \neq t'$

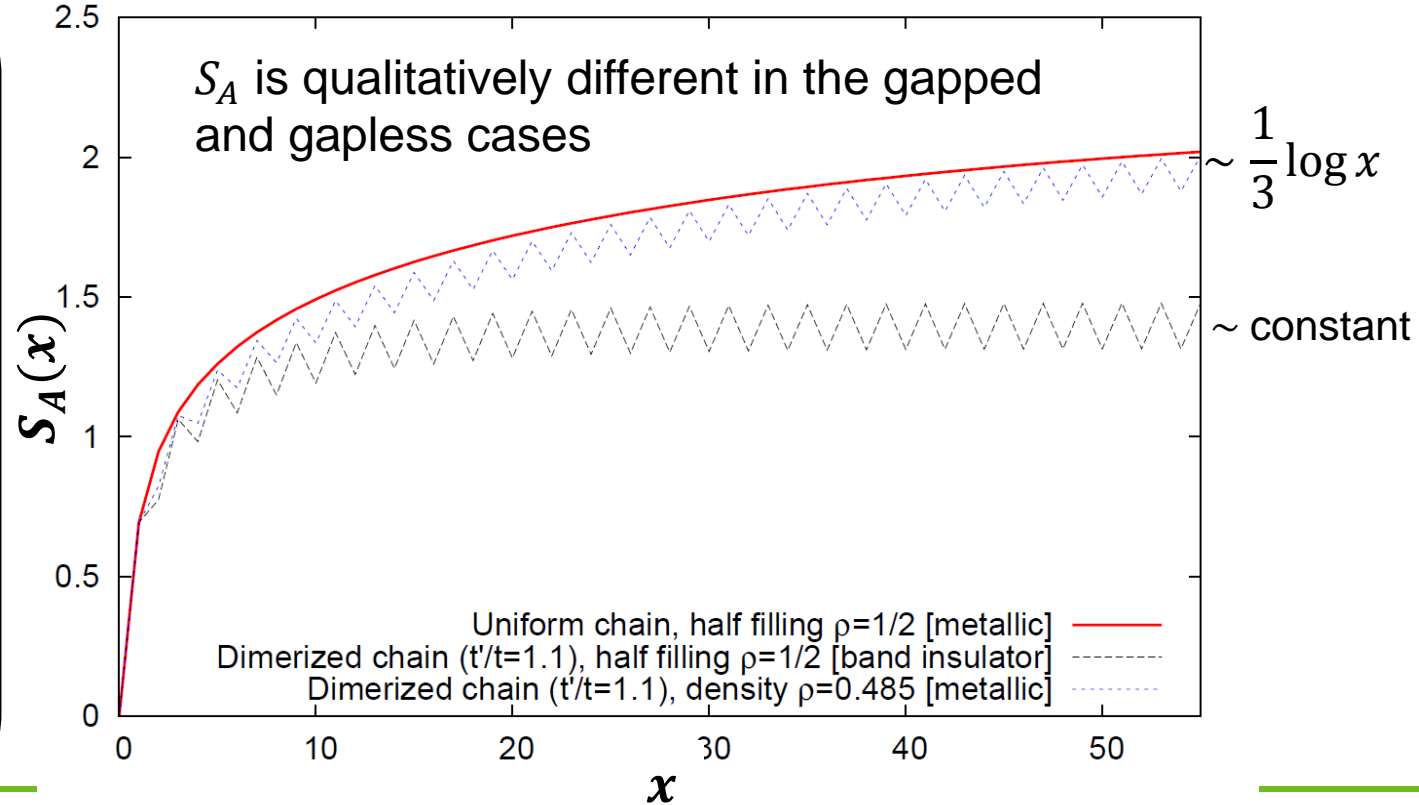

Log(L) term in presence of a Fermi surface in $d \geq 2$

“Violation of the Entropic Area Law for Fermions”

M. M. Wolf, [Phys. Rev. Lett. 96, 010404 \(2006\)](#)

“Entanglement Entropy of Fermions in Any Dimension and the Widom Conjecture”

D. Gioev & I. Klich, [Phys. Rev. Lett. 96, 100503 \(2006\)](#)

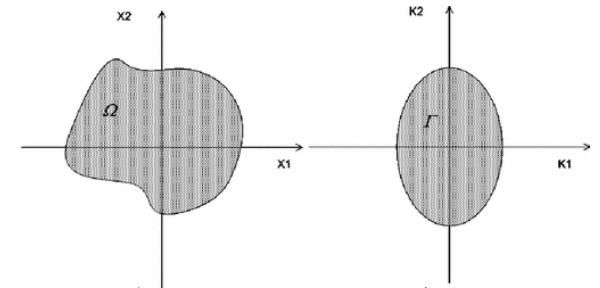

$$S = \frac{L^{d-1}}{(2\pi)^{d-1}} \frac{\log L}{12} \iint |n_x \cdot n_k| dA_x dA_k$$

Boundary law violation in presence of a Fermi surface

Simple geometric argument: “Entanglement Entropy and the Fermi Surface”

B. Swingle, [Phys. Rev. Lett. 105, 050502 \(2010\)](#)

- Free-fermion tight-binding model

$$H = \sum_{i,j} t_{ij} (c_i^\dagger c_j + \text{h.c.}) = \sum_{k \in 1^{\text{st}} \text{ BZ}} \epsilon_k c_k^\dagger c_k$$

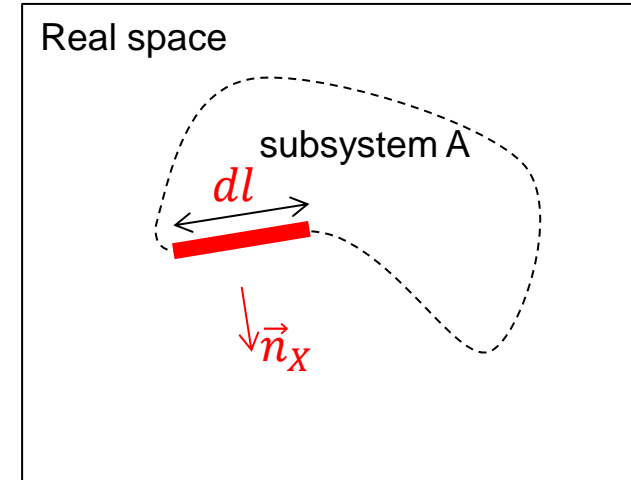
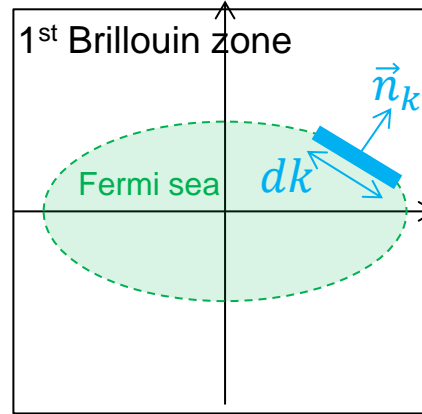

- Contribution of the modes dk and boundary element dl to the entanglement entropy S_A ?

→ Idea: model this contribution by **decoupled chains** running parallel to the \vec{n}_k direction (insures the same propagation direction for the low-energy modes):

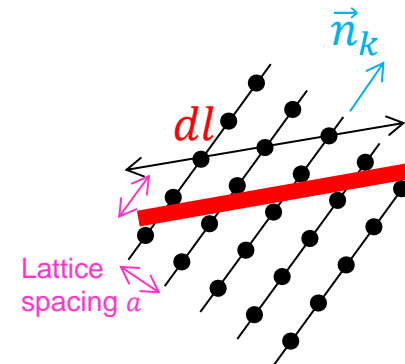

Boundary law violation in presence of a Fermi surface

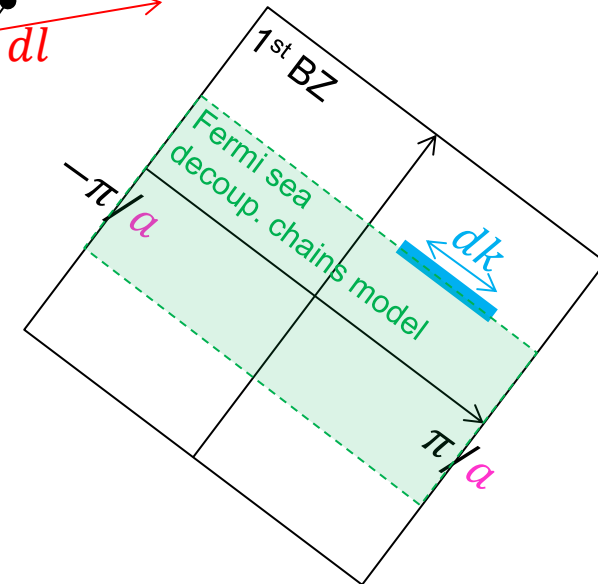
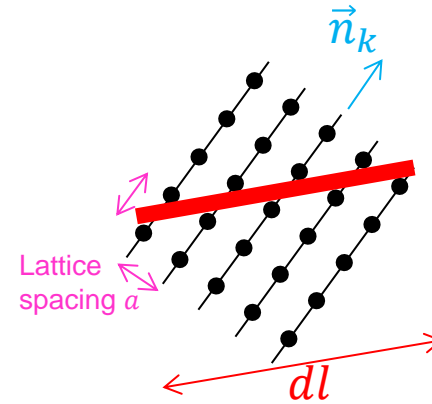
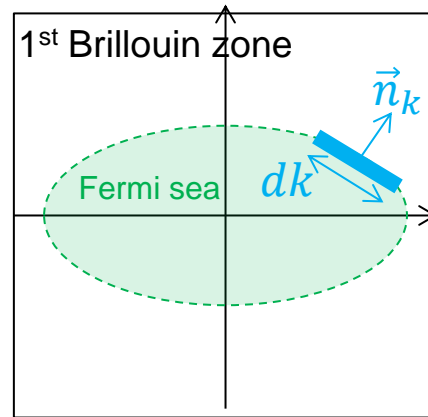
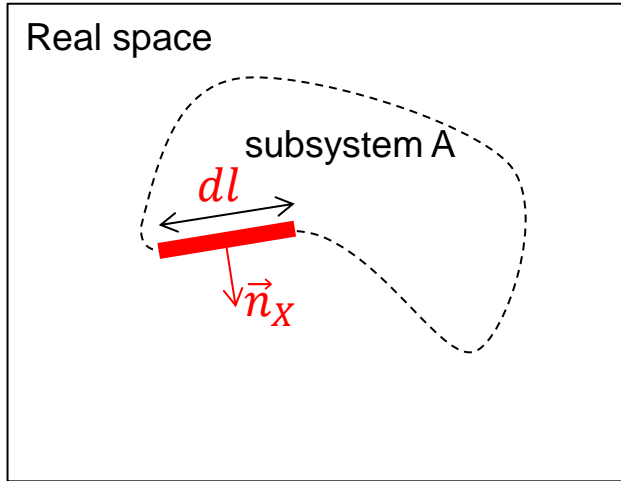

- Number of chains crossing the boundary:

$$dN = \frac{dl}{a} |\vec{n}_k \cdot \vec{n}_x|$$

- Entropy contribution of each chain:

$$dS_A^{\text{decoupled chains}} = \frac{1}{6} \log(L) \times dN$$

- Correct by the length of the element along the Fermi surface (relative to that of the decoupled chain model)

$$dS_A = dS_A^{\text{decoupled chains}} \times \frac{dk}{2 \times \frac{2\pi}{a}} = \frac{1}{12} \log(L) \times \frac{dl}{a} |\vec{n}_k \cdot \vec{n}_x| \times \frac{adk}{2\pi}$$

Integrating on the real space boundary and Fermi surface:
Turns out to be exact ! (and related to Windom's conjecture)

$$S_A = \frac{1}{12} \log(L) \iint dl \frac{dk}{2\pi} |\vec{n}_k \cdot \vec{n}_x|$$

$$\sim \mathcal{O}(L \log L)$$

Boundary law violation in presence of a Fermi surface

“Entanglement scaling in critical two-dimensional fermionic and bosonic systems”, T. Barthel, M.-C. Chung, & U. Schollwöck

[Phys. Rev. A 74, 022329 \(2006\)](#)

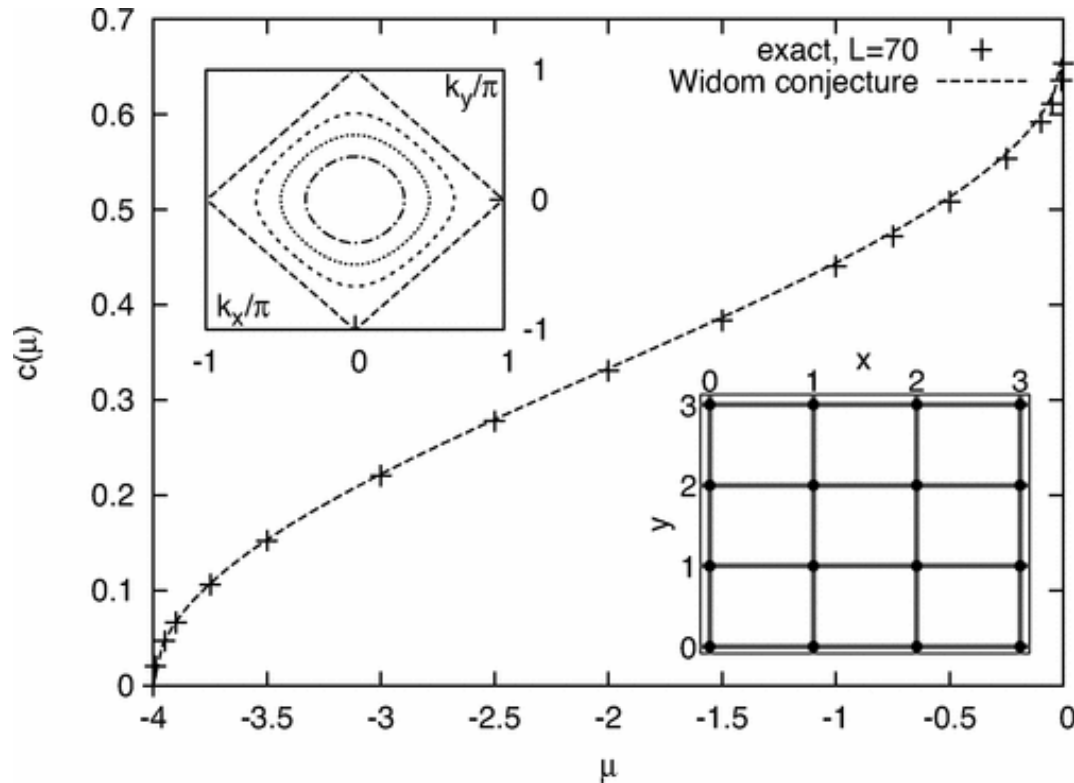

The prefactor $c(\mu)$ in the entanglement entropy scaling law as a function of the chemical potential μ for the ground-state of the two-dimensional fermionic tight-binding model in comparison to the result of Gioev and Klich. Insets show the hopping parameters and the Fermi surfaces for $\mu = -3, -2, -1, 0$. [From Barthel *et al.* 2006]

Critical systems in 1d & CFT

... the celebrated $S \sim \frac{c}{3} \log(L)$ formula

Entanglement & CFT

Nucl. Phys B424 (1994)

Geometric and renormalized entropy in conformal field theory

Christoph Holzhey^a, Finn Larsen^{a,*}, Frank Wilczek^{b,**}

^a *Department of Physics, Joseph Henry Laboratories, Princeton University, Princeton, NJ 08544, USA*

^b *School of Natural Sciences, Institute for Advanced Study, Olden Lane, Princeton, NJ 08540, USA*

Received 25 March 1994; accepted 2 May 1994

J. Stat. Mech 2004

Journal of Statistical Mechanics: Theory and Experiment
An IOP and SISSA journal

Entanglement entropy and quantum field theory

Pasquale Calabrese^{1,3} and John Cardy^{1,2}

¹ Rudolf Peierls Centre for Theoretical Physics, 1 Keble Road, Oxford OX1 3NP, UK

² All Souls College, Oxford, UK

E-mail: calabres@thphys.ox.ac.uk

$$S \sim \frac{c}{3} \log(L)$$

+Review: Calabrese & Cardy, [J. Phys. A 42, 504005 \(2009\)](#)

Numerics & entanglement in critical spin chains

“Entanglement in Quantum Critical Phenomena”

G. Vidal, J. I. Latorre, E. Rico, and A. Kitaev, [Phys. Rev. Lett. 90, \(2003\)](#)

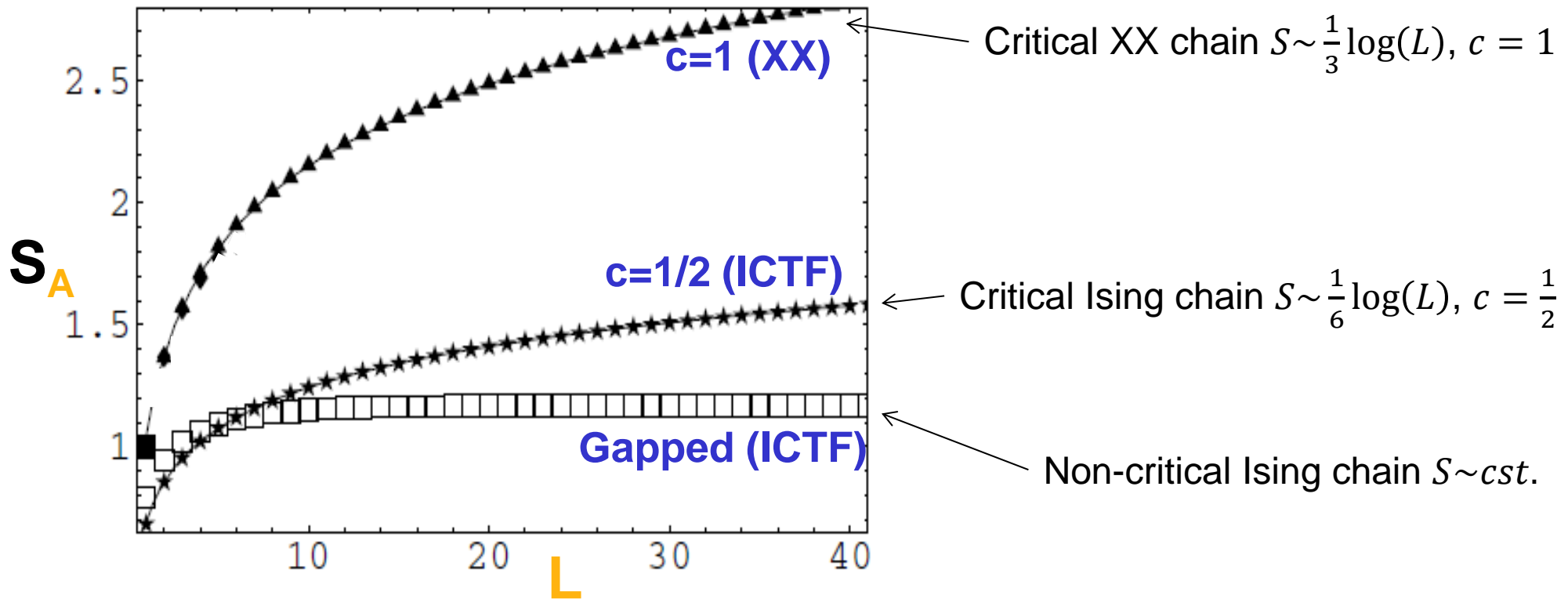

Quantum system in $d=1$ & partition functions in $d=2$

Functional/path integral \leftrightarrow imaginary time evolution

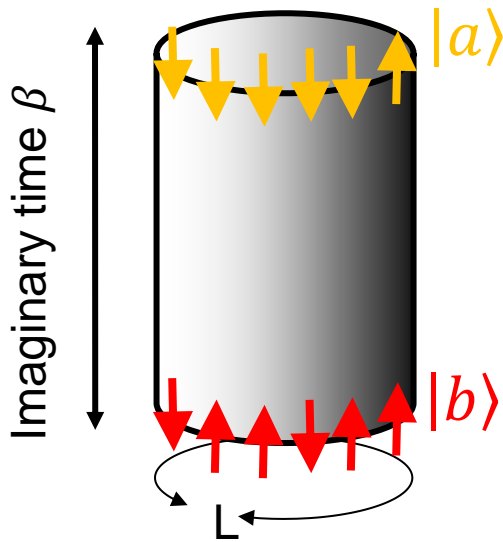

□ Thermal density matrix $\rho = \frac{1}{Z} \exp(-\beta H)$, with $Z = \text{Tr}[e^{-\beta H}]$

$\langle a | \rho | b \rangle = \frac{1}{Z} \times$ cylinder “partition function”
with boundary conditions $|a\rangle$ and $|b\rangle$

Z : torus partition function

□ Ground-state wave function given by infinitely long cylinder partition functions :

$$\lim_{\beta \rightarrow \infty} \exp(-\beta H) = e^{-\beta E_0} |\psi\rangle\langle\psi|$$

$$|\psi\rangle \sim \lim_{\beta \rightarrow \infty} \exp(-\beta H) |0\rangle$$

Any **state** with some overlap with the ground-state

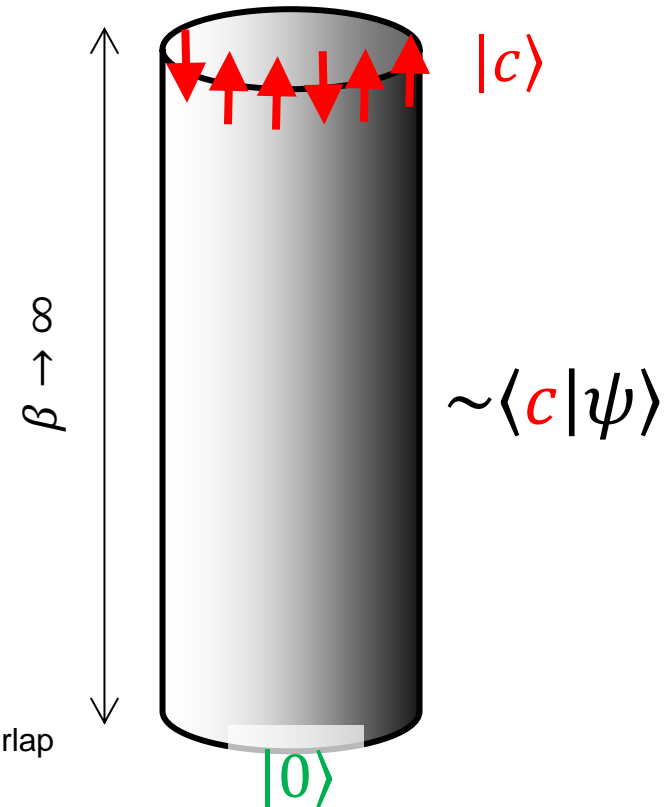

Critical system in d=1 & CFT

□ Critical 1d system:

- gapless in the thermodynamic limit
- (some) correlation functions decay algebraically with distance

□ Examples

- Critical Ising chain in transverse field $H = -\sum_n \sigma_n^z S_{n+1}^z - h \sum_n S_n^x$ with $h = 1$
- Spin- $\frac{1}{2}$ XXZ spin chain $H = \sum_n (S_n^x S_{n+1}^x + S_n^y S_{n+1}^y) + \Delta \sum_n S_n^z S_{n+1}^z$ with $\Delta \in]-1, 1[$
- 1d Hubbard model $H = -t \sum_n (c_{\uparrow,n}^\dagger c_{\uparrow,n+1} + c_{\downarrow,n}^\dagger c_{\downarrow,n+1} + \text{H. c.})$
 $+ U \sum_n (c_{\uparrow,n}^\dagger c_{\uparrow,n} + c_{\downarrow,n}^\dagger c_{\downarrow,n} + \text{H. c.})$
- Edge of a quantum 2d Hall system
- ...

} Luttinger liquids

□ Continuum limit and CFT

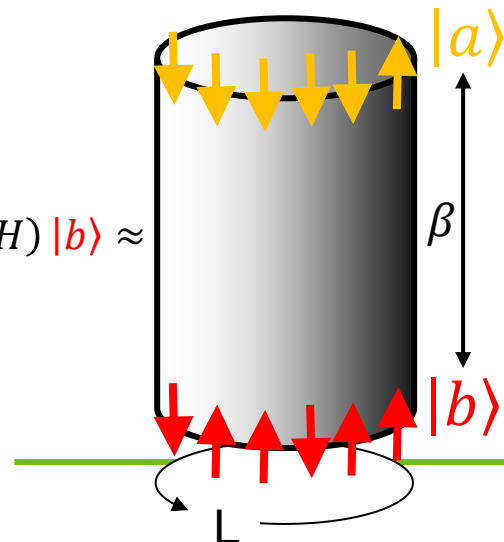

The universal / long-distance properties of the system are obtained by replacing the microscopic density matrix $\rho = \frac{1}{Z} \exp(-\beta H)$ by the corresponding cylinder CFT partition function (with the appropriate boundary conditions, corresponding to “coarse grained” versions of the states $|a\rangle$ and $|b\rangle$)

Reduced density matrix & 2d partition functions

$$\rho_A = \text{Tr}_B[\rho] \quad \langle a|\rho_A|a'\rangle = \sum_{|b\rangle} \langle ab|\rho|a'b\rangle$$

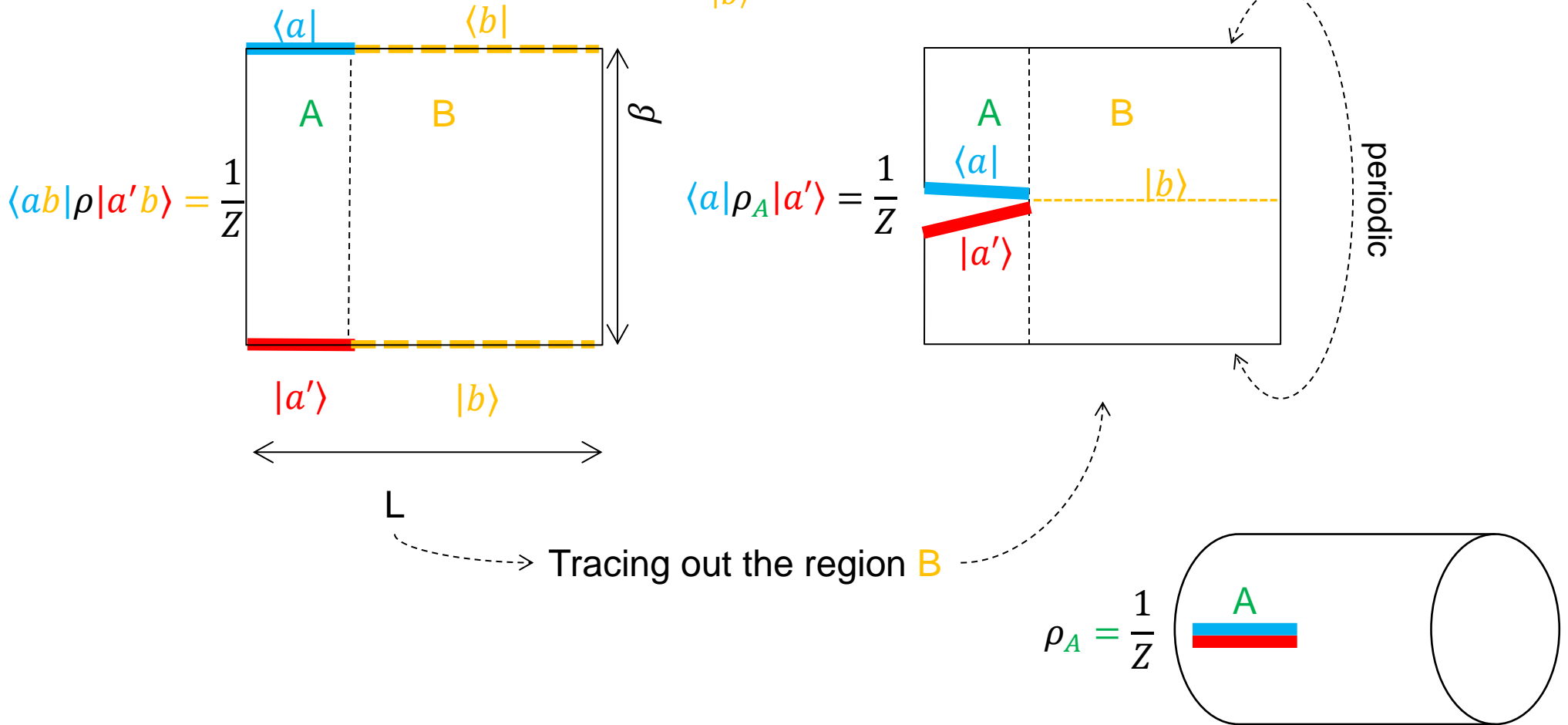

Rényi entropy & partition functions

- Reduced density matrix to the power n

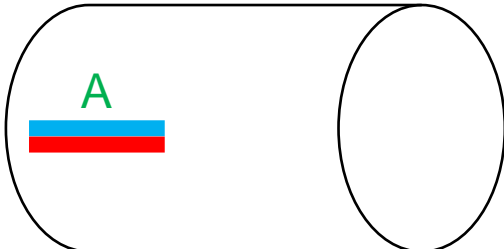
$$\rho_A = \frac{1}{Z} \left(\text{Cylinder with region A} \right)$$

Z : cylinder partition function

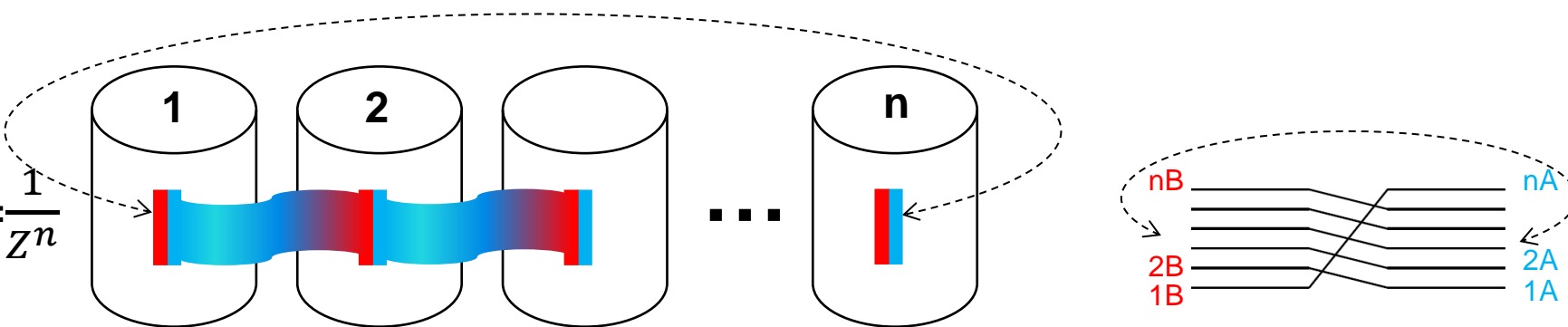
$$\text{Tr}[\rho_A^n] = \frac{1}{Z^n}$$

- Some remarks:

- The slits of the n cylinders are “glued” cyclically to obtain the trace \rightarrow Riemann surface with n sheets.
- Consider a path encircling one end of the segment $A \rightarrow$ moves to the next cylinder. n turns are needed to get back to the origin.

Entanglement & CFT (2)

Holzhey, Larsen & Wilcek, Nucl. Phys B 424 (1994)

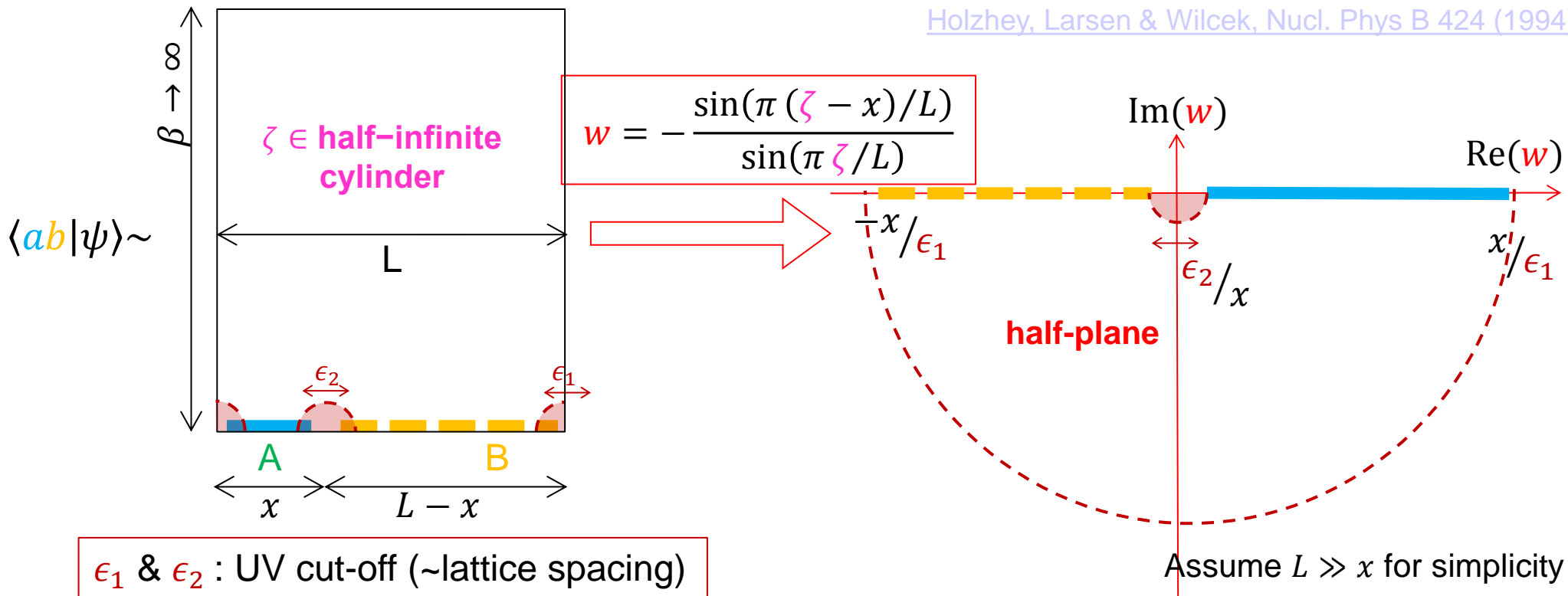

Remarks:

- Without the cut-offs, there would be infinitely many degrees of freedom close to the boundary between A and B, and their contribution to the entanglement entropy would diverge.
- The actual conformal mapping which maps the cylinder without the excluded regions to the $\frac{1}{2}$ annulus (right picture) is complicated, but its precise form is not needed in what follows.

Entanglement & CFT (3) – mapping to a conical singularity

Holzhey, Larsen & Wilcek, Nucl. Phys B424 (1994)

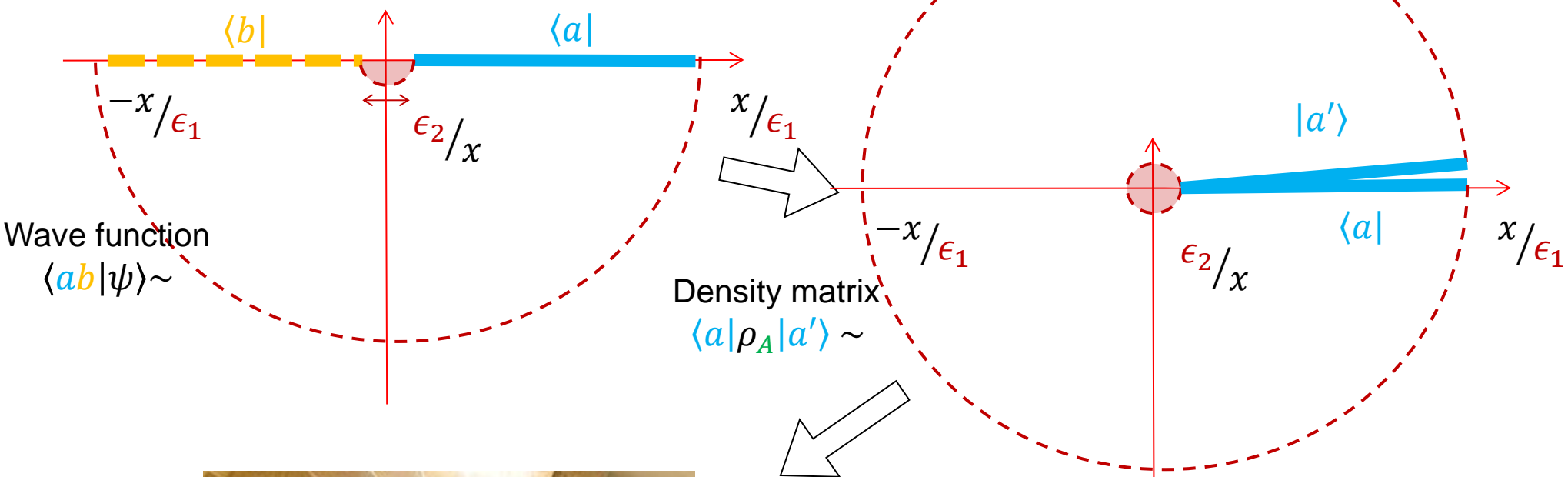

Wave function
 $\langle ab | \psi \rangle \sim$

Density matrix
 $\langle a | \rho_A | a' \rangle \sim$

$\rho_A^n \sim$
 (n levels)



$$\text{Tr}[\rho_A^{n=1-\alpha}] = \frac{Z_{\text{cone angle } 2n\pi}}{(Z_{\text{disk}})^n}$$

$$\log(\text{Tr}[\rho_A^n]) = \frac{c}{6} \left(\frac{1}{n} - n \right) \log \frac{x}{\epsilon}$$

(this can be calculated by mapping the disk to the cone using $z \rightarrow w(z) = z^n$, and compute the associated Shwarzian derivative – see next slide)

Conical singularity
 ($\frac{\epsilon}{x} \rightarrow 0$), with angle deficit $2\alpha\pi$.

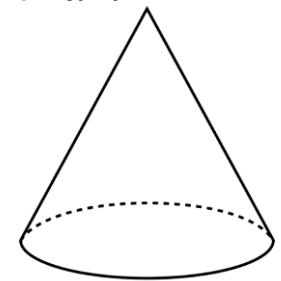

Entanglement & CFT (4) – Free energy of a cone

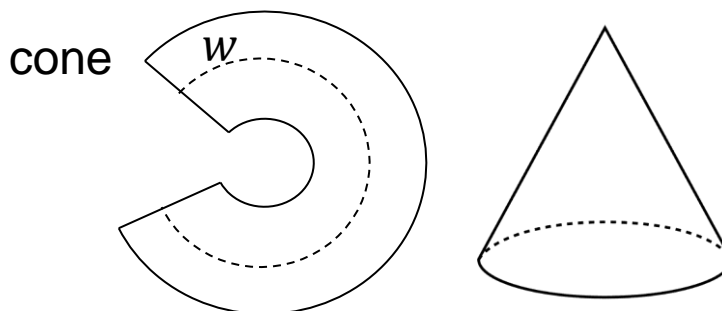
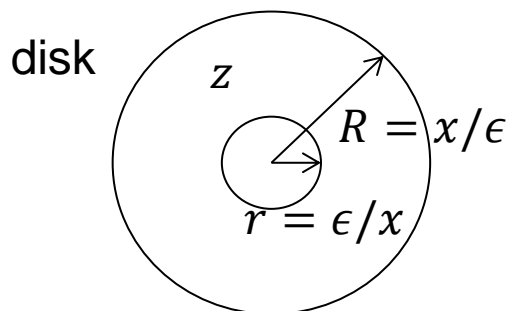

$$R/r = \left(\frac{x}{\epsilon}\right)^2$$

Mapping from the disk to the cone: $z \rightarrow w(z) = z^n \quad w' = nz^{n-1} \quad w'' = n(n-1)z^{n-2}$

Stress energy tensor (holomorphic part) in the disk geometry: $T_d(z)$. Stress In the cone geometry: $T_c(w)$

They are related to each other through a standard CFT transformation law, which involves the Scharzian derivative:

$$T_c(w) = \frac{1}{(w')^2} \left[T_d(z) - \frac{c}{12} \left(\frac{w'''}{w'} - \frac{3}{2} \left(\frac{w''}{w'} \right)^2 \right) \right]$$

Here we find $T_c(w) = \frac{T_d(z)}{(w')^2} + \frac{c}{24w^2} \left(1 - \frac{1}{n^2} \right)$. Integrating the stress energy tensor (times w) along the dashed line gives the variation of $\log Z_c(n)$ with respect to the outer radius R (keeping the inner radius r fixed) :

$$\frac{\partial \log Z_c(n)}{\partial \log R} = \frac{i}{2\pi} \int w dw \langle T_c(w) \rangle + \text{H. c.}$$

And from the relation above between $T_d(z)$ and $T_c(w)$ one can show that :

$$\frac{\partial \log[Z_c(n)/Z_d]}{\partial \log R} = \frac{i}{2\pi} \int w dw \frac{c}{24w^2} \left(1 - \frac{1}{n^2} \right) + \text{H. c.} = \frac{c}{12} \left(\frac{1}{n} - n \right)$$

So we have $\log[Z_c(n)/Z_d] = \frac{c}{12} \left(\frac{1}{n} - n \right) \log R$. By conformal invariance, this should in fact be a function of $\frac{R}{r}$ and therefore: $\log[Z_c(n)/Z_d] = \frac{c}{12} \left(\frac{1}{n} - n \right) \log \frac{R}{r} = \frac{c}{6} \left(\frac{1}{n} - n \right) \log \frac{x}{\epsilon}$. This is the result announced on the previous slide.

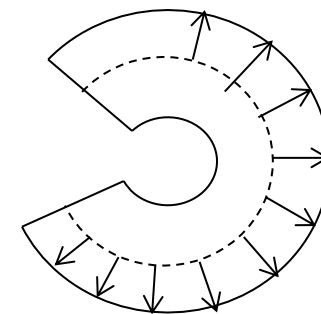

Entanglement *spectrum* in a 1d critical system

“Entanglement spectrum in one-dimensional systems”

P. Calabrese & A. Lefevre, [Phys. Rev. A 78, 032329 \(2008\)](#)

The previous calculation gave $\text{Tr}[\rho_A^n] = Z(n)/Z(1)^n$

$$\log \text{Tr}[\rho_A^n] = \log R_n = \log Z(n) - n \log Z(1) \sim \frac{c}{6} \left(\frac{1}{n} - n \right) \log \frac{x}{\epsilon}$$

□ From this, what can be said about the eigenvalues of ρ_A ?

- Density of “states”: $P(\lambda) = \sum_i \delta(\lambda - \lambda_i)$, with λ_i : eigenvalues of ρ_A
The moments $R_n = \sum_i \lambda_i^n$ have a relatively simple dependence on n :

$$R_n = e^{-b \left(n - \frac{1}{n} \right)} \text{ with } b = \frac{c}{6} \log \frac{x}{\epsilon}$$

- After a some mathematical manipulations... one obtains the (CFT) density of eigenvalues :

$$P(\lambda) = \delta(\lambda_{\max} - \lambda) + \frac{b \theta(\lambda_{\max} - \lambda)}{\lambda \sqrt{b \ln(\lambda_{\max}/\lambda)}} I_1(2 \sqrt{b \ln(\lambda_{\max}/\lambda)})$$

$$\text{with } \lambda_{\max} = e^{-b} = \left(\frac{x}{\epsilon} \right)^{-\frac{c}{6}} \text{ (largest eigenvalue)}$$

Entanglement *spectrum* in a 1d critical system

P. Calabrese & A. Lefevre, [Phys. Rev. A 78, 032329 \(2008\)](#)

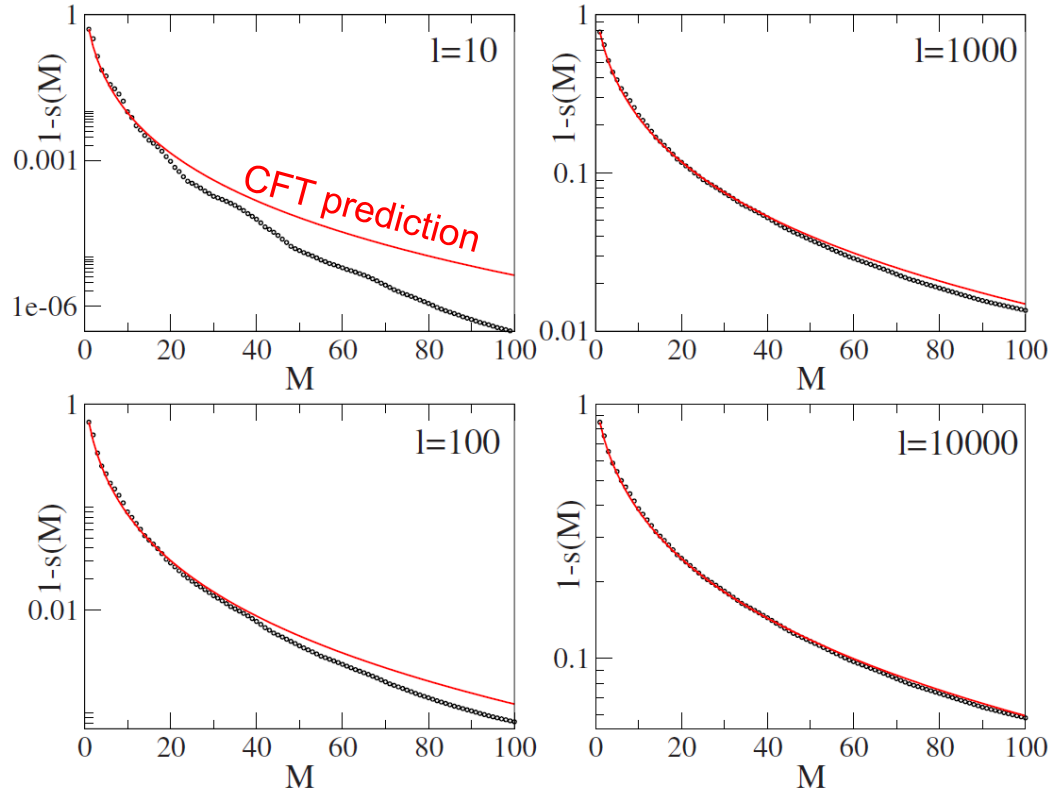

FIG. 1. (Color online) Sum of the first M eigenvalues of the XX model up to $M=100$: $1-s(M)$ as function of M for $\ell = 10, 100, 1000, 10\,000$ (black dots). The red line is the conformal field theory prediction, Eq. (9), in which λ_{\max} has been fixed to the maximum eigenvalue obtained numerically.

$$s(M) = \sum_{i=1 \dots M} \lambda_i$$

By construction: $s(M \rightarrow \infty) = 1$
 If one keeps only the M first eigenvalues, the discarded weight is $1 - s(M)$.

$$s(M) \equiv \sum_{i=1}^M \lambda_i \rightarrow \lambda_{\max} \left(1 + \int_0^{I_0^{-1}(M)} dy e^{-y^2/4b} I_1(y) \right)$$

How do the properties of the of the approximate (truncated) wave-function vary with M ?

→ “finite-entanglement scaling”

L. Tagliacozzo *et al.* [PRB 78, 024410 \(2008\)](#)
 + many others...

CFT & entropy of two disjoint intervals

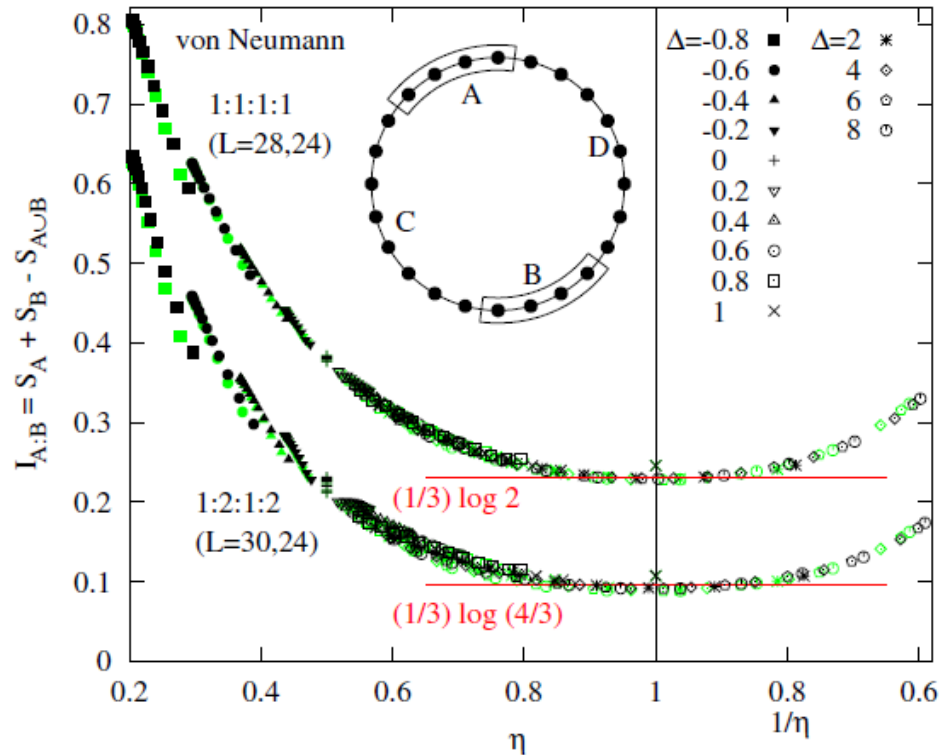

FIG. 1 (color online). The mutual information for fixed divisions $r_A:r_C:r_B:r_D = 1:1:1:1$ and $1:2:1:2$, versus $\eta = 2\pi R^2$. We set the magnetization at $M = \frac{k}{L}$ with $k = 0, 1, \dots, \frac{L}{2} - 3$ for $-1 < \Delta \leq 1$ and with $k = 1, \dots, \frac{L}{2} - 3$ for $1 < \Delta$, so that the system is inside the critical phase. Black and green points correspond to the larger ($L = 28, 30$) and smaller ($L = 24$) systems, respectively. Horizontal red lines indicate the Calabrese-Cardy result (4).

□ S. Furukawa, V. Pasquier, and J. Shiraishi. “Mutual Information and boson radius in a $c=1$ critical system in one dimension”. [Phys. Rev. Lett., 102, 170602, 2009](#)

The mutual information of two disjoint intervals contains more information about the long-distance properties than just the central charge (as for a single interval).

In this example of critical spin chains with $c=1$ (Tomonaga-Luttinger liquid phase in the XXZ spin chain) $I(A:B)$ is a function of the so-called “compactification radius” (related to the exponent of several spin-spin correlation functions).

Matrix-product states

to describe weakly-entangled states in 1d,
canonical (G. Vidal's) form

Matrix-product states

Review on DMRG
(and MPS)

The density-matrix renormalization group in the age of
matrix product states

Ulrich Schollwöck *

*Department of Physics, Arnold Sommerfeld Center for Theoretical Physics and Center for NanoScience, University of Munich,
Theresienstrasse 37, 80333 Munich, Germany
Germany Institute for Advanced Study Berlin, Wallotstrasse 19, 14159 Berlin, Germany*

[Ann. of Phys. 326, 96-192 \(2011\)](#)

*“A practical introduction to tensor networks: Matrix product
states and projected entangled pair states”*

Román Orús, [Ann. of Phys. 349, 117 \(2014\)](#)

Original paper: *“Density matrix formulation for quantum renormalization groups”*,
S. R. White, [Phys. Rev. Lett. 69, 2863 \(1992\)](#) >2500 citations in WoS

MPS & canonical Vidal's form (1)

G. Vidal, [Phys. Rev. Lett. 91, 147902 \(2003\)](#)

- Start from the wave function on an open chain of length L (here a spin-1/2 example for simplicity):

$$|\psi\rangle = \sum_{\sigma_1, \dots, \sigma_L = \uparrow, \downarrow} M_{\sigma_1, \dots, \sigma_L} |\sigma_1, \dots, \sigma_L\rangle$$

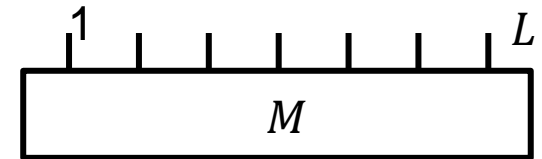

2^L coefficients

- Split the chain in two parts $[1 \dots n] - [n + 1 \dots L]$, and define the associated Schmidt basis and singular values:

$$|\psi\rangle = \sum_l \lambda_l^{[n]} |\Phi_l^{[1 \dots n]}\rangle \otimes |\Phi_l^{[n+1 \dots L]}\rangle$$

- Graphically:

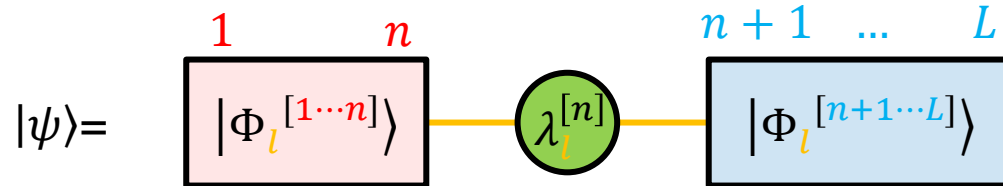

- In practice this decomposition can be obtained by « reshaping » M as rectangular matrix of size $2^n * 2^{L-n}$: $M_{\sigma_1, \dots, \sigma_L} = M_{(\sigma_1, \dots, \sigma_n), (\sigma_{n+1}, \dots, \sigma_L)}$ and performing its singular value decomposition (SVD).
- We assume that $|\psi\rangle$ can be approximated using some low rank truncation with at most χ Schmidt values.

MPS & canonical Vidal's form (2)

- Compare the Schmidt decompositions on two successive bonds:

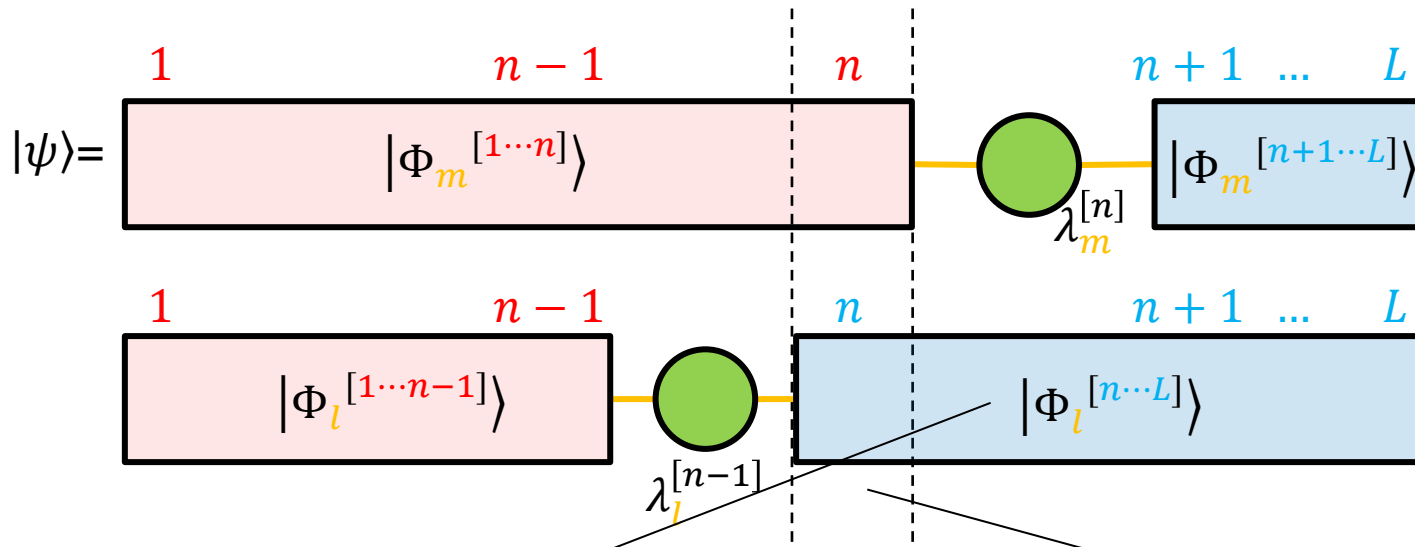

- Write the Schmidt state $|\Phi_l^{[n\cdots L]}\rangle$ in the orthogonal basis $\{|\uparrow\rangle_n, |\downarrow\rangle_n\} \otimes \{\lambda_m^{[n]}|\Phi_m^{[n+1\cdots L]}\}$
- This defines on (each site n) two matrices $\Gamma^{[n]\uparrow}$ and $\Gamma^{[n]\downarrow}$ of dimension $\chi * \chi$:

$$|\Phi_l^{[n\cdots L]}\rangle = \sum_{\substack{\sigma=\uparrow,\downarrow \\ m=1 \dots \chi}} \Gamma_{l,m}^{[n]\sigma} |\sigma\rangle_n \lambda_m^{[n]} |\Phi_m^{[n+1\cdots L]}\rangle$$

MPS & canonical Vidal's form (2)

- Graphically :

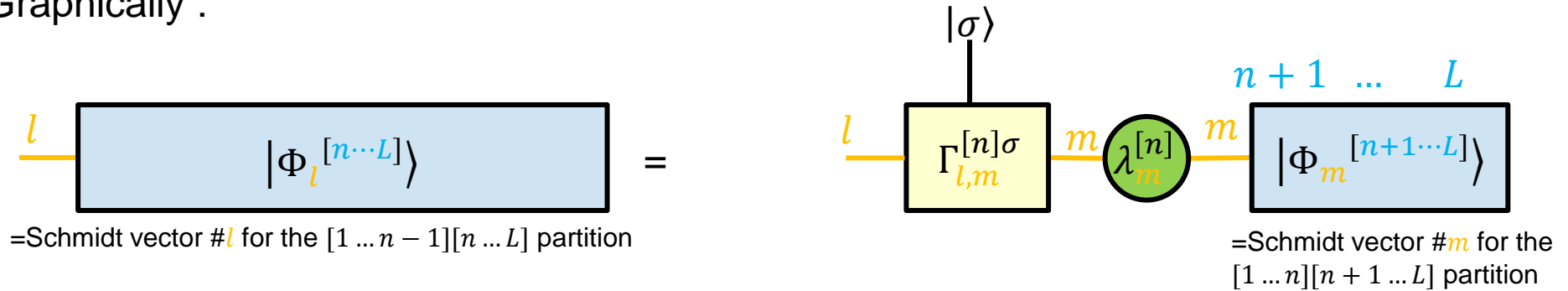

- Repeat the procedure along the chain to construct all the matrices $\Gamma^{[n]\uparrow}$ and $\Gamma^{[n]\downarrow}$ from the Schmidt basis.

Finally:

$$|\psi\rangle = \sum_{\substack{\sigma_1, \sigma_2, \dots, \sigma_L = \uparrow, \downarrow \\ k, l, m, \dots, z = 1 \dots \chi}} \Gamma^{[1]} \begin{array}{c} |\sigma_1\rangle \\ \Gamma^{[1]} \end{array} \begin{array}{c} \lambda^{[1]} \\ \bullet \end{array} \Gamma^{[2]} \begin{array}{c} |\sigma_2\rangle \\ \Gamma^{[2]} \end{array} \begin{array}{c} \lambda^{[2]} \\ \bullet \end{array} \Gamma^{[3]} \begin{array}{c} |\sigma_3\rangle \\ \Gamma^{[3]} \end{array} \begin{array}{c} \lambda^{[3]} \\ \bullet \end{array} \dots \begin{array}{c} \lambda^{[L-1]} \\ \bullet \end{array} \Gamma^{[L]} \begin{array}{c} |\sigma_L\rangle \\ \Gamma^{[L]} \end{array}$$

$$= \sum_{\substack{\sigma_1, \sigma_2, \dots, \sigma_L = \uparrow, \downarrow \\ k, l, m, \dots, z = 1 \dots \chi}} \Gamma_k^{[1]\sigma_1} \lambda_k^{[1]} \Gamma_{k,l}^{[2]\sigma_2} \lambda_l^{[2]} \Gamma_{l,m}^{[3]\sigma_3} \lambda_m^{[3]} \dots \lambda_z^{[L-1]} \Gamma_z^{[L-1]\sigma_L} |\sigma_1\rangle |\sigma_2\rangle \dots |\sigma_L\rangle$$

- Encodes **all** the left-right Schmidt decomposition
- Storage:** $\sim L * (\chi + 2\chi^2) \ll 2^L$ if χ can be kept $\mathcal{O}(1)$ [gapped system] or, at worse, $\mathcal{O}(L^\alpha)$ [critical]

MPS & canonical Vidal's form (3)

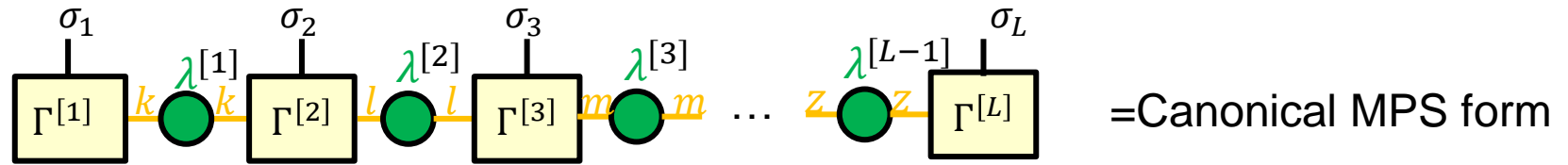

- Allows to reconstruct the Schmidt decomposition for any left/right partition

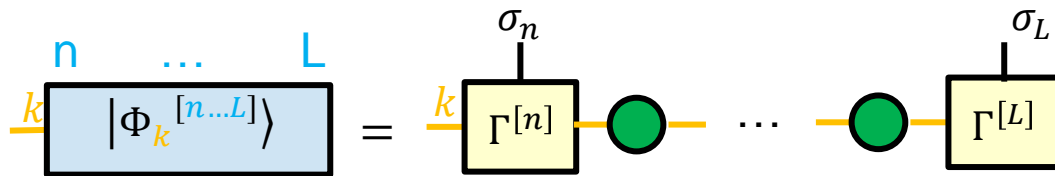

- Orthogonality of the Schmidt vectors

$$\langle \Phi_k^{[n...L]} | \Phi_{k'}^{[n...L]} \rangle =$$

$$= \delta_{kk'} \sum_{\sigma_n, \sigma_{n+1}, \dots, \sigma_L = \uparrow, \downarrow}$$

nb: automatically insures $\langle \psi | \psi \rangle = 1$

MPS & canonical Vidal's form (4)

Local observables. Example of a 2-spin operator

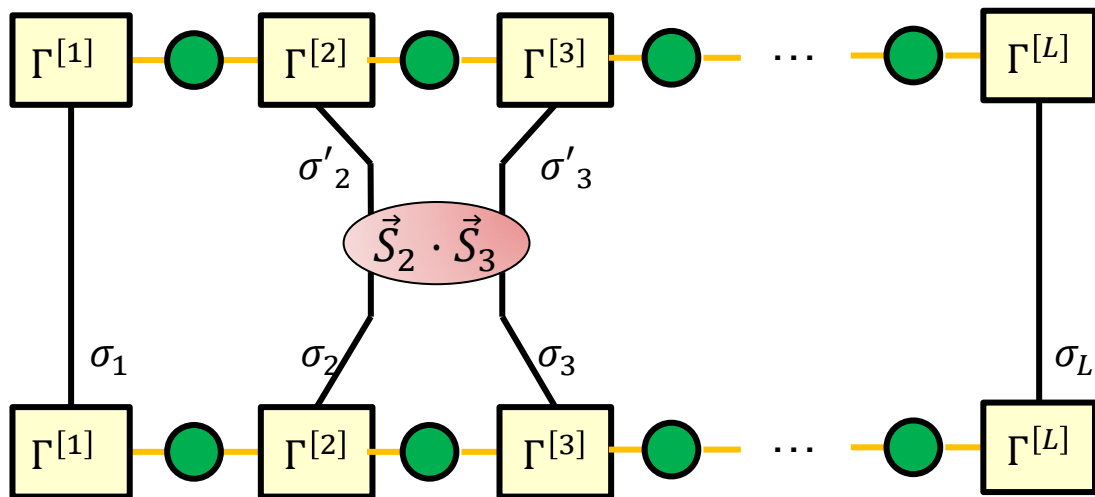

$$\begin{matrix} \sigma_i & | & \sigma_j \\ \sigma'_i & | & \sigma'_j \end{matrix} \langle \vec{S}_i \cdot \vec{S}_j \rangle = \langle \sigma'_i \sigma'_j | \vec{S}_i \cdot \vec{S}_{i+1} | \sigma_i \sigma_j \rangle$$

$$= \langle \psi | \vec{S}_i \cdot \vec{S}_{i+1} | \psi \rangle$$

orthogonality of the Schmidt vectors

=

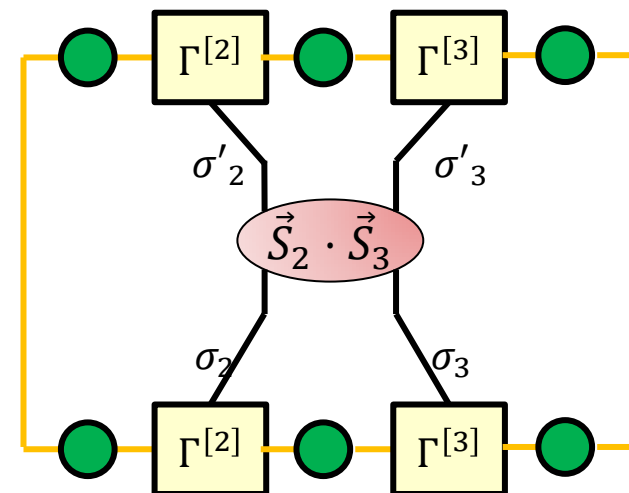

Only local operations required

MPS Algorithms

- Many algorithms exist to compute et manipulate MPS on long chains :
 - Variational algorithms: successively optimize the tensors to lower the energy and obtain the ground-state of a given Hamiltonian (DMRG)
 - Alternative approach: perform an imaginary-time evolution to get the ground-state (TEBD)
 - Perform the (unitary) time evolution starting from an arbitrary state (t-DMRG & TEBD)
 - Infinite-chain methods (iTEBD)
 - Extension to finite-temperature (i.e. MPS to describe mixed states)

□ Example: two-site unitary operation

- Consider unitary “gate” $U_{n,n+1}$ acting on sites n and $n + 1$:

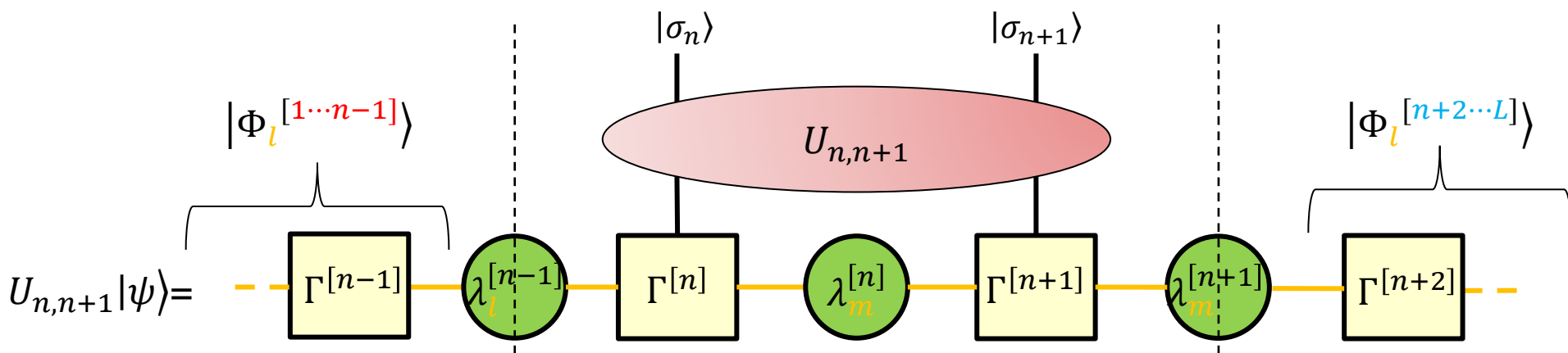

- The schmidt values $\lambda_l^{[n-1]}$ and Schmidt basis $|\Phi_l^{[1\cdots n-1]}\rangle$ are not modified by $U_{n,n+1}$
- Same for $\lambda_m^{[n+1]}$ and the basis $|\Phi_l^{[n+2\cdots L]}\rangle$
- Only $\Gamma^{[n]}, \Gamma^{[n+1]}$ $\lambda_m^{[n]}$ need to be updated \rightarrow fast local updates $\mathcal{O}(\chi^3)$

- Using small time steps, the observation above can be used to compute the real time evolution (here for nearest-neighbor spin-spin interactions):

Summary of lecture #3

- Dimerized (free fermion) chain: “metal versus band insulator”

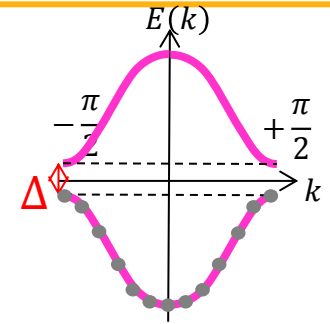

- Fermi surface contribution to the entanglement in $d > 1$
[Gioev & Klich , 2006]

$$S = \frac{L^{d-1}}{(2\pi)^{d-1}} \frac{\log L}{12} \iint |n_x \cdot n_k| dA_x dA_k$$

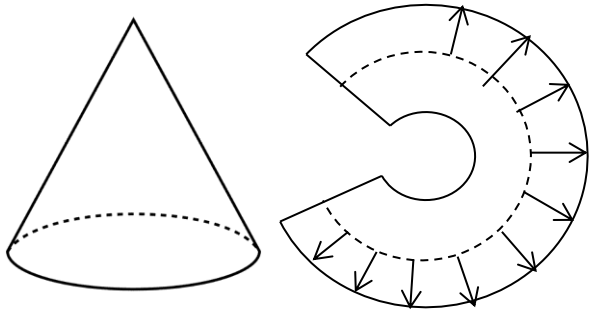

- Entanglement in critical 1d systems & conformal field theory
[Holzhey-Larsen Wilckek 1994]

$$S \sim \frac{c}{3} \log L$$

- Entanglement spectrum from CFT – decay of the Schmidt values [Calabrese Lefevre 2008]
- Two intervals: more information than the central charge [Furukawa-Pasquier-Shiraishi 2009]
- Matrix product states: a powerful way to encode (weakly entangled) states

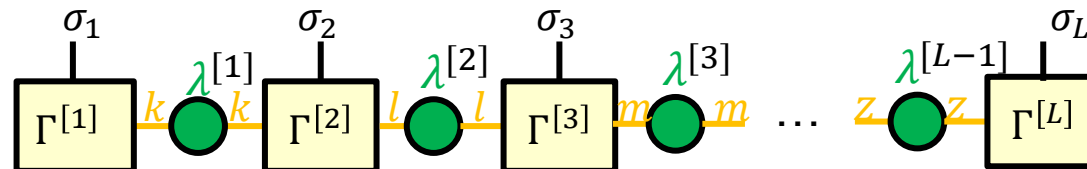

Tensor-product states in $d > 1$

How to generalize MPS to $d > 1$?

□ “Snake” MPS

- Quite powerful in practice (produced new results on several frustrated spin systems)
- But... problem with the area law \rightarrow requires and exponential growth the the matrix dimension with the transverse dimension
- Reference: “*Studying Two-Dimensional Systems with the Density Matrix Renormalization Group*”
E. M. Stoudenmire and S. R. White [Ann. Rev. of Cond. Mat. Phys. 3, 111 \(2012\)](#)

□ Use tensor networks (=more than two virtual indices)

- Finite-rank tensor can reproduce area laws
- High computation cost in practice (to perform contractions, tensor optimizations, ...), but very promising.

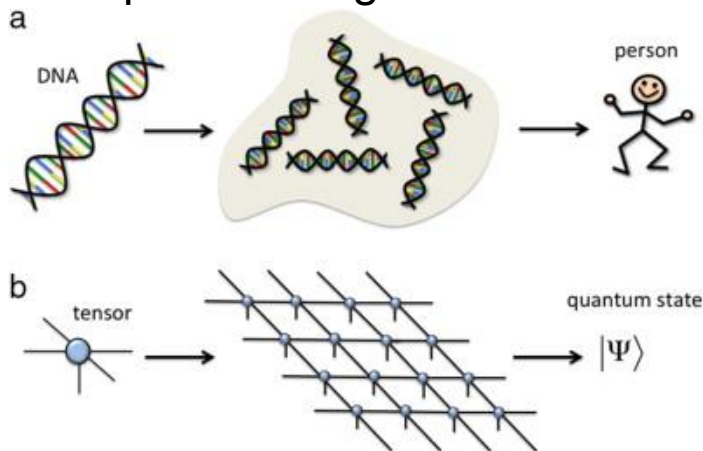

“A practical introduction to tensor networks: Matrix product states and projected entangled pair states”

Román Orús, [Ann. of Phys. 349, 117 \(2014\)](#)

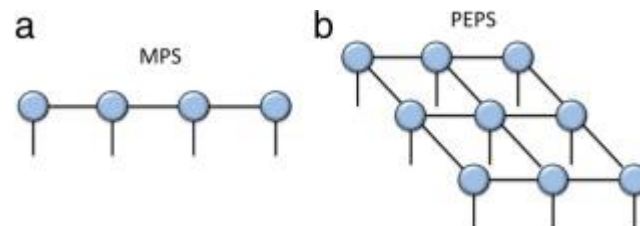

Multi-scale Entanglement Renormalization Ansatz

“Entanglement Renormalization”, G. Vidal [Phys. Rev. Lett. 99, 220405 \(2007\)](#);
 “Class of Quantum Many-Body States That Can Be Efficiently Simulated”,
 G. Vidal [Phys. Rev. Lett. 101, 110501 \(2008\)](#).

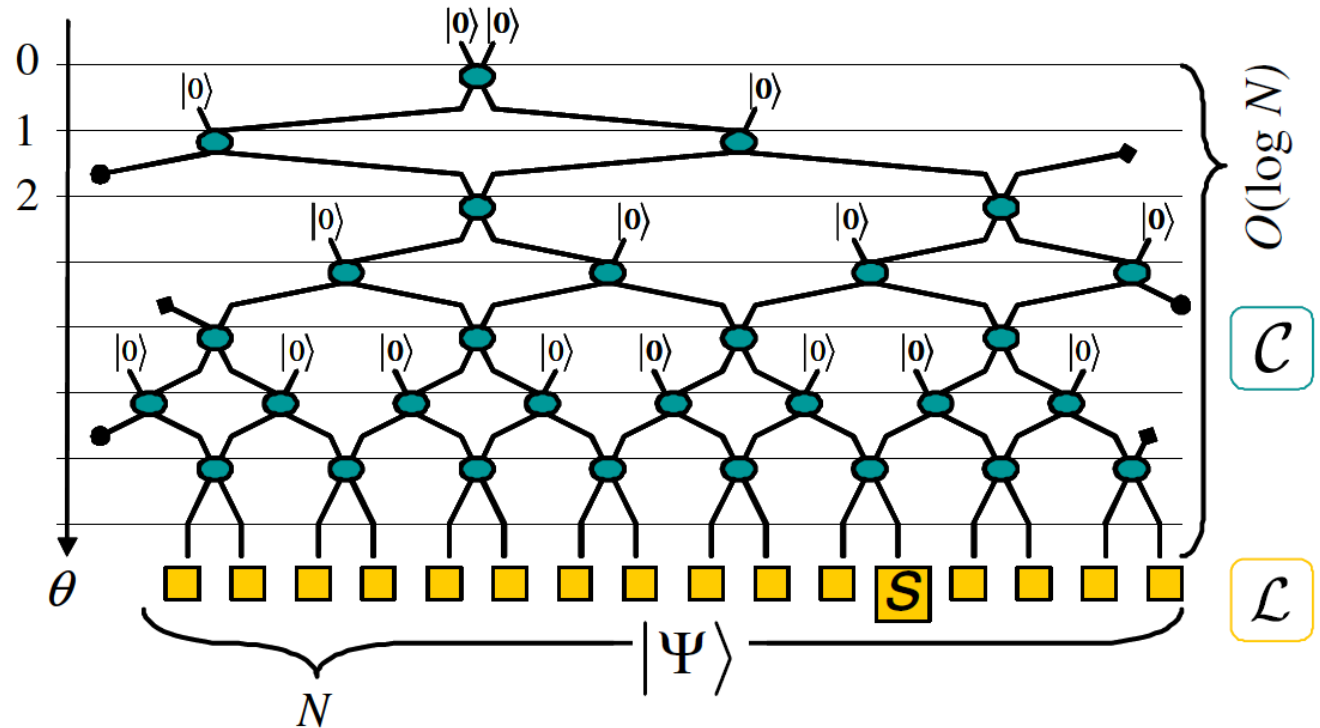

- Can reproduce the $S \sim \frac{c}{3} \log l$ behavior with constant tensor dimensions
 → adapted for 1d critical systems (and generalizations exists in $d > 1$)
- The different “layers” of the network correspond to different length scales (RG idea)

Corrections to the area law in 2d systems

2 examples showing (universal) subleading corrections: a magnet with gapless Goldstone modes (spin waves) and a quantum dimer model in a “topological” (\mathbb{Z}_2) phase

Area law in 2d – spin 1/2 Heisenberg model

“Anomalies in the entanglement properties of the square-lattice Heisenberg model”

A. B. Kallin, M. B. Hastings, R. G. Melko & R. R. P. Singh, [Phys. Rev. B 84, 165134 \(2011\)](#)

+see also: D. J. Luitz, X. Plat, F. Alet, & N. Laflorencie, [Phys. Rev. B 91, 155145 \(2015\)](#)

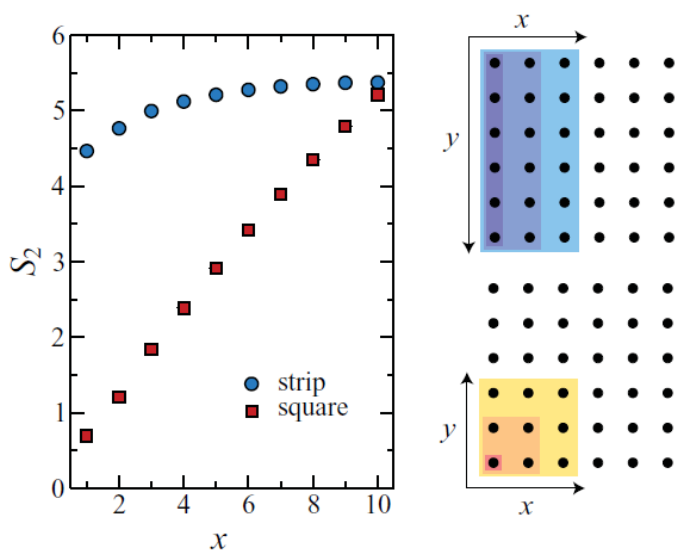

FIG. 3. (Color online) (Left) The Renyi entropy for a 20×20 PBC system versus the width (x) of region A for both the square and strip geometries. The boundary length does not change with the region width for strip geometry (since its height y traverses the periodic lattice), thus the entropy approaches a constant value. For square geometry the boundary length is $4x$. In both geometries the entropy scales with the length of the boundary, with that scaling becoming better as the width of region A approaches half the system size. At right, the “strip” (top) and “square” (bottom) geometries on a 6×6 lattice.

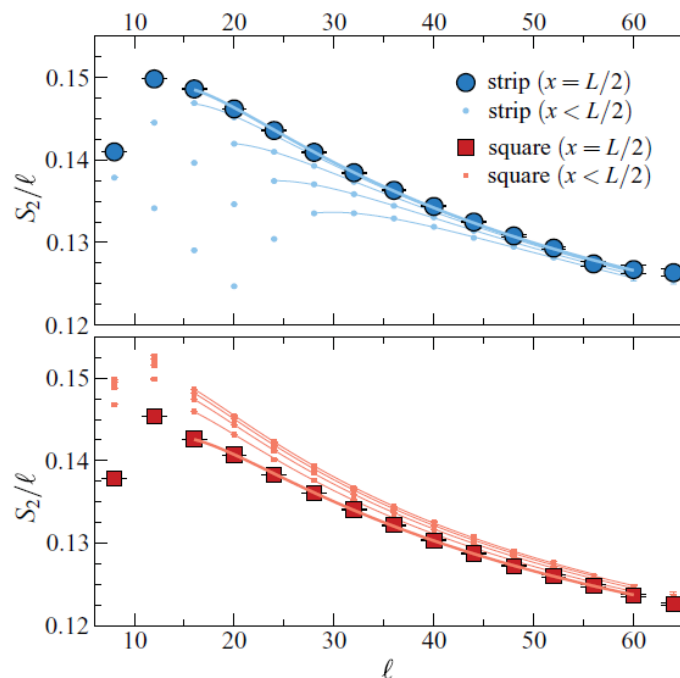

FIG. 5. (Color online) S_2/ℓ vs. ℓ , where ℓ is the boundary length of region A , for regions with square and strip geometry embedded in $L \times L$ systems with periodic boundary conditions. The data sets outlined in black correspond to region A with width $x = L/2$ for both geometries. The other data sets use smaller region A of the same geometries. Fits to Eq. (9) are included for all data, and the coefficients found are listed in Table I.

Magnetic long-range order \leftrightarrow spontaneous SU(2) symmetry breaking
 \rightarrow gapless spin waves (Goldstone modes)
 \rightarrow additive $\log(L)$ correction to the entanglement entropy.

$$\frac{f(\ell)}{\ell} = a + \frac{c}{\ell} \ln(\ell) + \frac{d}{\ell}$$

area law coeff.

Metlitsky-Grover [2011] \rightarrow the coefficient of the $\log(l)$ term is $c = \frac{N_G}{2}$ (in $d = 2$) where N_G is the number of Nambu-Goldstone modes (consistent with the numerics above).

Area law in 2d – quantum dimer model

Quantum **dimer** model wave-function

S. Furukawa & GM, [Phys Rev B 2007](#)
 J.-M. Stéphan, GM & V. Pasquier [J. Stat. Mech. 2012](#)

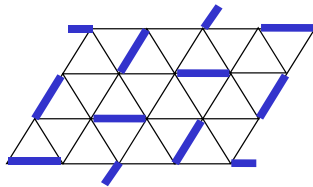

$$|\psi\rangle = \sum_{c \in \left\{ \begin{array}{l} \text{all the hard-core} \\ \text{dimer coverings} \\ \text{of the triangular lattice} \end{array} \right\}} |c\rangle$$

= Equal amplitude superposition
 Local hard-core constraint

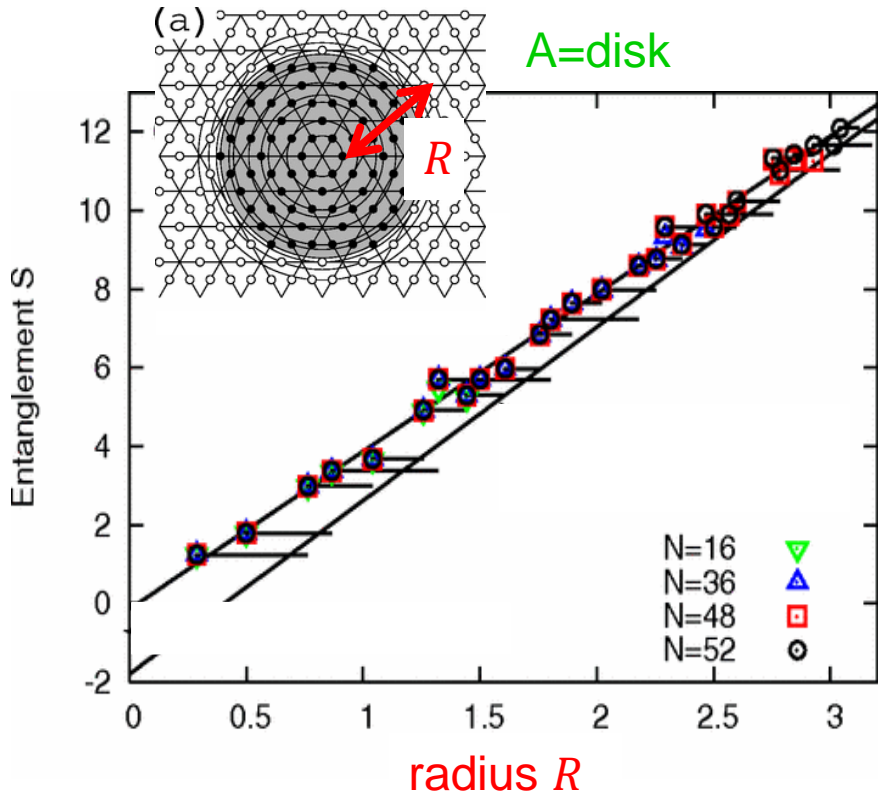

$L_x \rightarrow \infty$

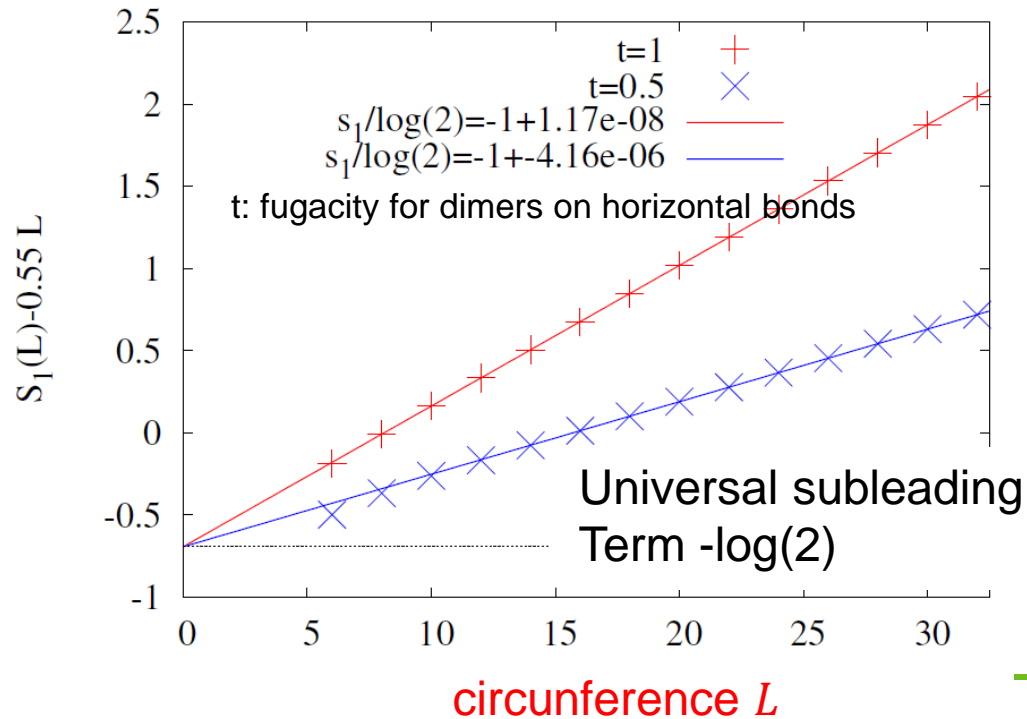

Bulk-edge correspondance in 2d

Relation between the entanglement 'Hamiltonian' and physical edge modes. Topological entanglement entropy

Topological phases of matter

□ Ground state properties

- No spontaneously broken symmetry, no local order parameter (“quantum liquids”)
- The ground-state degeneracy depends on the topology
- Degenerate ground-state are locally undistinguishable

Example of a Z_2
Liquid :

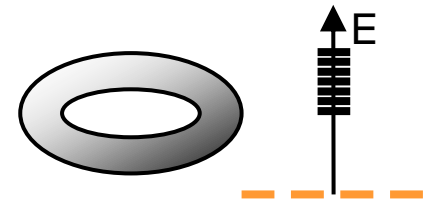
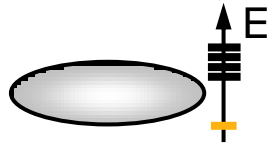

□ Elementary excitations

- Excitations are gapped (at least in the bulk)
- Quantum number fractionalization (elementary excitations must be created in pairs, and can then be separated far away)
Examples: fractional electric charges (FQHE), or spin-1/2 excitations in magnetic insulators
- Exotic statistics in 2d (can be different from fermions & bosons, and can even be non-Abelian)

□ Examples

- Theoretical realizations: many models with fermions, bosons, spins, strings, dimers ...
- Experimental realizations:
 - **fractional quantum Hall effect**
 - some exotic superconductors ?
 - some magnetic insulators (spin liquids) ?

□ Closely related phases :

- *Integer* quantum Hall effect
- Topological insulators
- ...

Fractional quantum Hall effect

«Two-Dimensional Magnetotransport in the Extreme Quantum Limit »

D. C. Tsui, H. L. Störmer, and A. C. Gossard, [Phys. Rev. Lett. 48, 1559 \(1982\)](#)

[Web of Science: ~2100 citations]

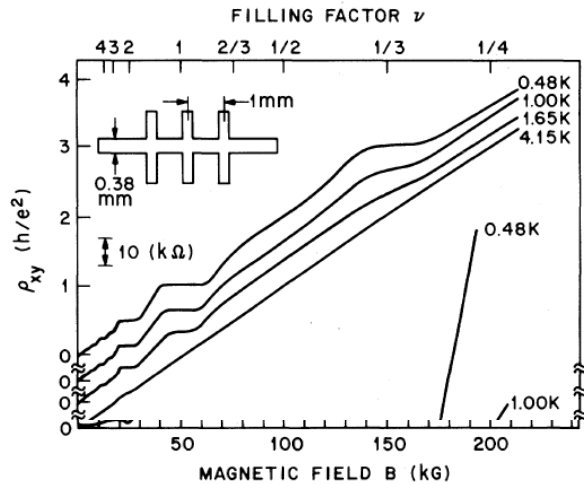

“Anomalous Quantum Hall Effect: An Incompressible Quantum Fluid with Fractionally Charged Excitations”,

R. B. Laughlin [Phys. Rev. Lett. 50, 1395](#)

(1983) [Web of Science: ~3000 citations]

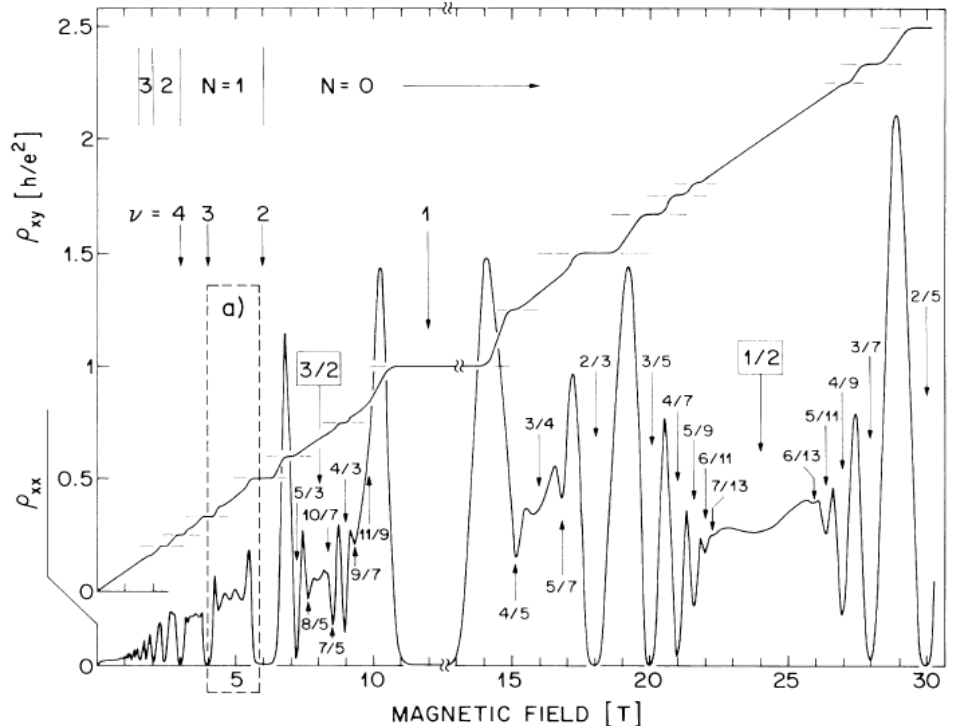

R. Willett, J. P. Eisenstein, H. L. Störmer, D. C. Tsui, A. C. Gossard, & J. H. English, [Phys. Rev. Lett. 59, 1776 \(1987\)](#)

$$\psi_{\text{Laughlin}}(\{z_i\}) = \prod_{j < k} (z_j - z_k)^m \exp\left(-\frac{1}{4} \sum_j |z_j|^2\right) \quad \nu = \frac{1}{m} \quad m: \text{odd integer}$$

Gapless edge modes

All the excitation in the bulk are gapped

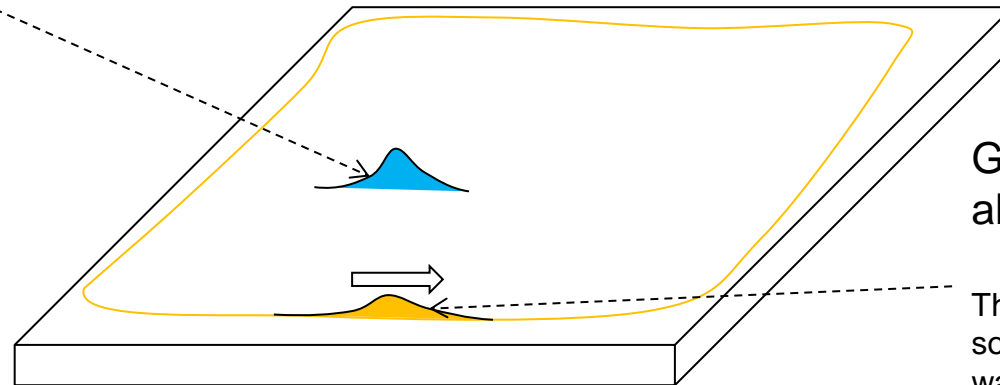

Gapless excitations exist along the *edge*.

This gaplessness is “protected” by some topological properties of the wave function in the bulk (and/or some symmetries)

Examples: Quantum hall phases, Chiral spin liquids, Topological insulators, ...

Bulk-edge correspondence in 2d (0)

- H. Li and F. D. M. Haldane, [Phys. Rev. Lett. 101, 010504 \(2008\)](#)

PRL 101, 010504 (2008)

PHYSICAL REVIEW LETTERS

week ending
4 JULY 2008

Entanglement Spectrum as a Generalization of Entanglement Entropy: Identification of Topological Order in Non-Abelian Fractional Quantum Hall Effect States

Hui Li and F. D. M. Haldane

Physics Department, Princeton University, Princeton, New Jersey 08544, USA

(Received 2 May 2008; published 3 July 2008)

- Xiao-Liang Qi, Hosho Katsura, and Andreas W. W. Ludwig, [Phys. Rev. Lett. 108, 196402 \(2012\)](#)

PRL 108, 196402 (2012)

PHYSICAL REVIEW LETTERS

week ending
11 MAY 2012

General Relationship between the Entanglement Spectrum and the Edge State Spectrum of Topological Quantum States

Xiao-Liang Qi,^{1,2} Hosho Katsura,^{3,4} and Andreas W. W. Ludwig⁵

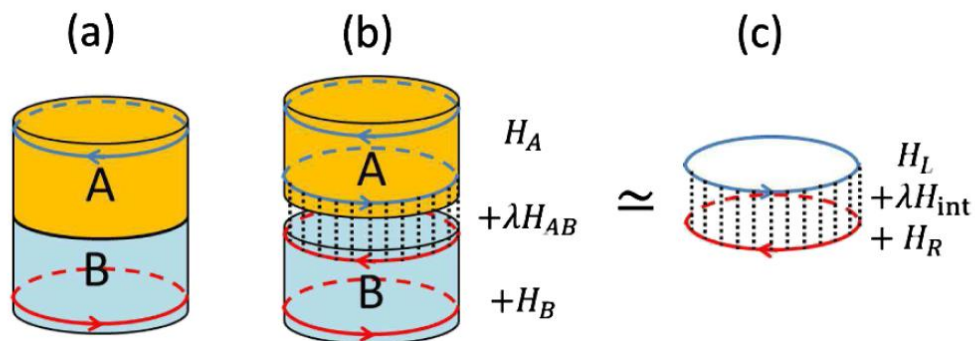

Bulk-edge correspondence in 2d (1)

Qi-Katsura-Ludwig argument in presence of gapless edge excitations

- Assumption 1: the system is gapped in the bulk, but with gapless edge states
Examples: integer Hall effect, fractional Hall effect, topological insulators, chiral spin liquids, ...
- Treat the coupling λ between A and B perturbatively. Assumption 2: there is some adiabatic continuity from $\lambda = 1$ (homogenous system) and $0 < \lambda \ll 1$ (two weakly coupled cylinders), and the result for the spectrum of the reduced density matrix will not qualitatively change.
- Due to the presence of a gap in the bulk, the (perturbative) ground state $|G\rangle$ can be described in the space of the low energy edge modes of A & B (this should at least be true if Δ is sent to ∞)

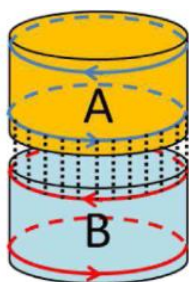
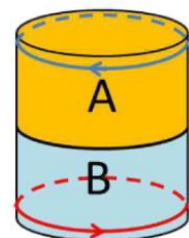

H_A
 $+\lambda H_{AB}$
 $+H_B$

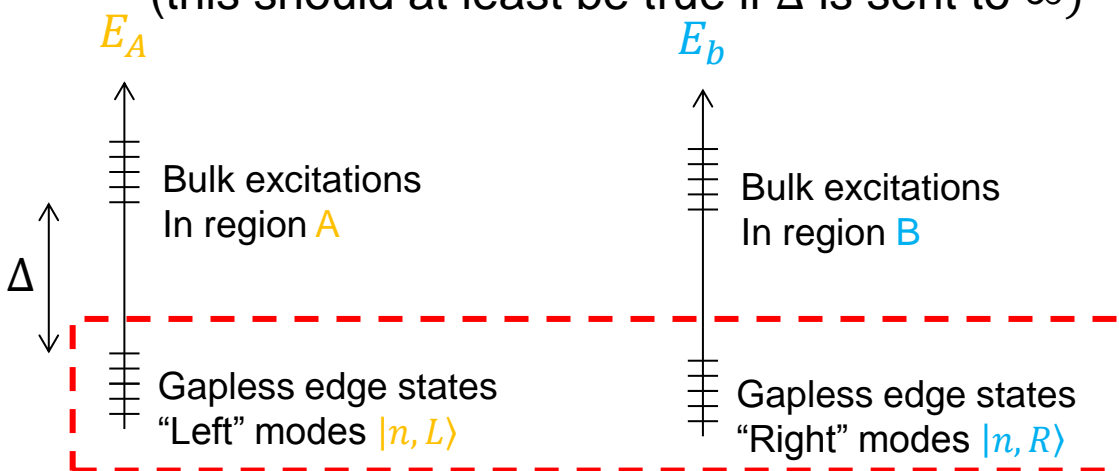

Two (weakly) coupled edges

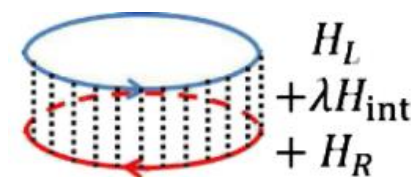

Bulk-edge correspondence in 2d (2)

Qi-Katsura-Ludwig argument: mapping to a quantum quench problem

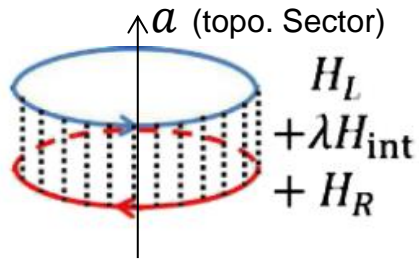

$t = 0$

$$|\psi(0)\rangle = |G\rangle$$

Ground-state of

$$H_L + \lambda H_{int} + H_R$$

$$\rho_L = \text{Tr}_R[|G\rangle\langle G|]$$

(L and R are entangled)

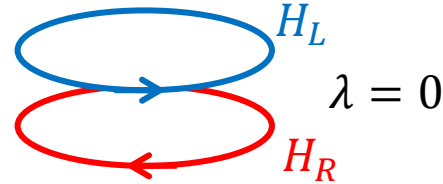

$t > 0$

$$|\psi(t)\rangle = e^{-iHt}|G\rangle$$

$$\rho_L(t) = e^{-iH_L t} \rho_L(0) e^{+iH_L t}$$

Entanglement entropy & spectrum of $\rho_L(t)$: independent of t .

Calabrese-Cardy (2006) result about the a global quench in a critical 1d system:

- to obtain the long time & long-distance correlations, the initial state can be replaced by $e^{-\tau(H_L+H_R)}|G^*\rangle$

- τ is a finite non-universal constant (“extrapolation length”).

- $|G^*\rangle$: scale/conformally-invariant boundary state (fixed point of an RG flow starting from $|G\rangle$).

- $|G^*\rangle$: scale/conformally-invariant boundary state (fixed point of an RG flow starting from $|G\rangle$).

- Rational CFT: $|G^*\rangle$ is a linear combination of all excited states, maximally entangled combination between the L and R edges.

$$|G^{*,a}\rangle \sim \sum_k \sum_j |k, j, a\rangle_L |k, j, a\rangle_R$$

$$e^{-\tau(H_L+H_R)}|G^{*,a}\rangle \sim \sum_{\text{momentum } k>0} e^{-2\tau\nu k} \sum_j |k, j, a\rangle_L | -k, j, a\rangle_R$$

$$\rho_{L,a} \sim \sum_{k>0} e^{-4\tau\nu k} \sum_j |k, j, a\rangle_L \langle k, j, a|_L \sim \exp(-4\tau H_L)$$

Entanglement Hamiltonian (universal part of): $\sim H_L$

(real space) Entanglement spectrum & quantum Hall effect

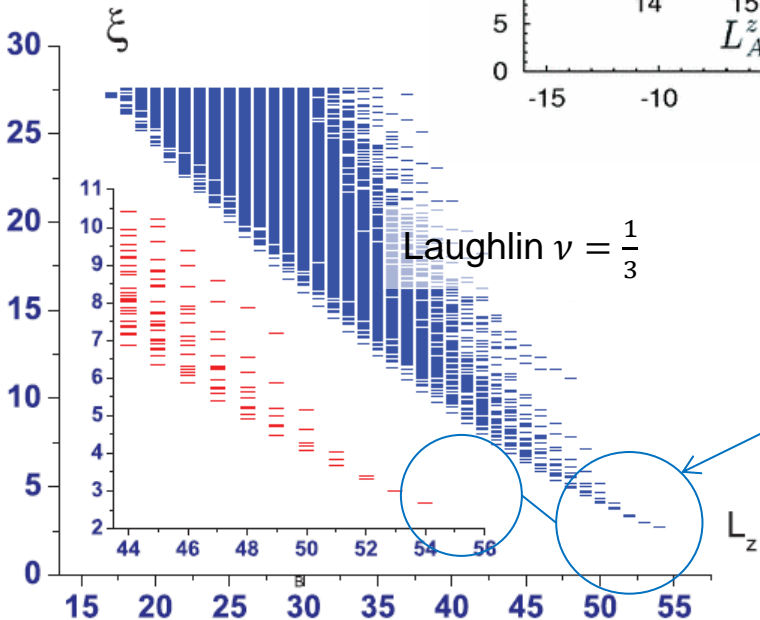
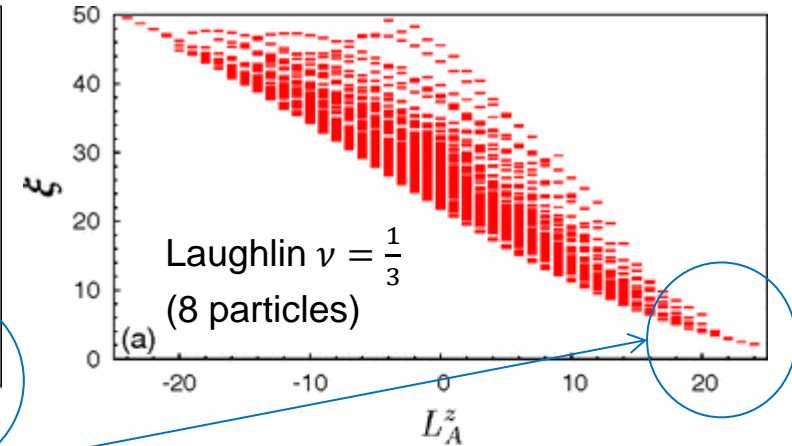
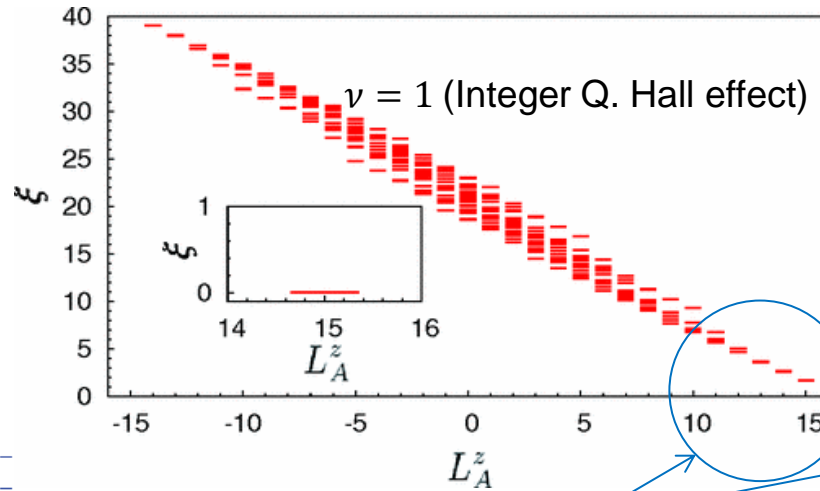

Low “energy” part of the entanglement spectrum is gapless (in the thermodynamic limit) has the same structure (linear dispersion & degeneracies) as that of a massless chiral free boson, which also describe the physical edge modes

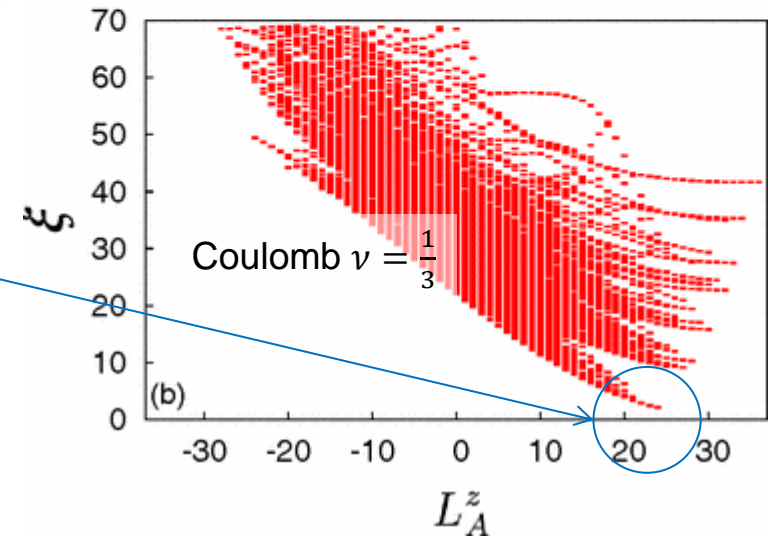

(12 particles, $\nu = \frac{1}{3}$ Laughlin’s state)
 J. Dubail, N. Read, and E. H. Rezayi,
[Phys. Rev. B 85, 115321 \(2012\)](#)

A. Sterdyniak, A. Chandran, N. Regnault,
 B. A. Bernevig, and P. Bonderson,
[Phys. Rev. B 85, 125308 \(2012\)](#)

Bulk-edge correspondence in 2d – Free fermion edge (1)

Toy model: free chiral fermions at the edge [Qi, Katsura & Ludwig *et al.* [PRL 2012](#)]

$$H_L = v \sum_k k c_k^\dagger c_k$$

$$H_R = -v \sum_k k d_k^\dagger d_k$$

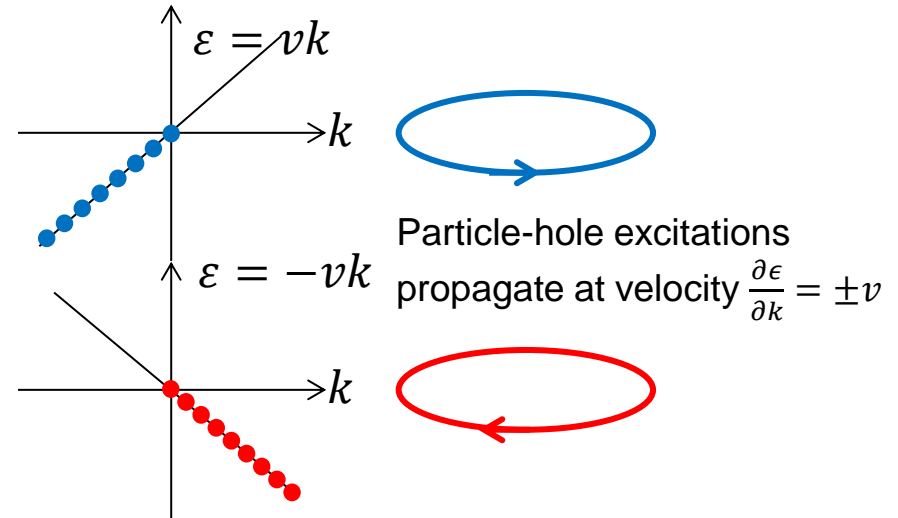

$H_{\text{int}} = \Delta \sum_k (c_k^\dagger d_k + d_k^\dagger c_k)$ = tunneling from one edge to another, with momentum conservation

$$H = H_L + H_R + H_{\text{int}} = \sum_k \begin{bmatrix} c_k^\dagger & d_k^\dagger \end{bmatrix} \begin{bmatrix} vk & \Delta \\ \Delta & -vk \end{bmatrix} \begin{bmatrix} c_k \\ d_k \end{bmatrix}$$

Diagonalization using new fermionic creation/annihilation operators:

$$H = \sum_k E_k (a_k^\dagger a_k - b_k^\dagger b_k), \quad E_k = \sqrt{(vk)^2 + \Delta^2} \quad (\rightarrow \text{gapped spectrum})$$

$$\begin{bmatrix} a_k \\ b_k \end{bmatrix} = \begin{bmatrix} \alpha_k & \beta_k \\ -\beta_k & \alpha_k \end{bmatrix} \begin{bmatrix} c_k \\ d_k \end{bmatrix} \quad \text{with } \alpha_k = \sqrt{\frac{E_k + vk}{2E_k}} \text{ and } \beta_k = \sqrt{\frac{E_k - vk}{2E_k}}$$

Bulk-edge correspondence in 2d – Free fermion edge (2)

Toy model: free chiral fermions at the edge [Qi, Katsura & Ludwig *et al.* [PRL 2012](#)]

$$\begin{bmatrix} a_k \\ b_k \end{bmatrix} = \begin{bmatrix} \alpha_k & \beta_k \\ -\beta_k & \alpha_k \end{bmatrix} \begin{bmatrix} c_k \\ d_k \end{bmatrix} \text{ with } \alpha_k = \sqrt{\frac{E_k + vk}{2E_k}} \text{ and } \beta_k = \sqrt{\frac{E_k - vk}{2E_k}}$$

Since the Hamiltonian is quadratic in the Fermion operators, it is “Gaussian” and can be written as some exponential of a quadratic form acting on some vacuum. In the present case we want to write the ground-state $|G\rangle$ of the two coupled edges in the form:

$$|G\rangle = \exp(-B) |G_L\rangle \otimes |G_R\rangle$$

where $|G_{L/R}\rangle$ is the ground-state of $H_{L/R}$. B should contain terms that “dress” the two edges by particle hole-excitations, keeping the total momentum as well as the total number of Fermions. B should therefore have the following form:

(using the $k \leftrightarrow -k$ & $L \leftrightarrow R$ symmetry)

$$B = \sum_{k>0} \lambda_k (c_k^\dagger d_k + d_{-k}^\dagger c_{-k})$$

How to determine λ_k ? Insure that $|G\rangle$ is annihilated by a_k (and b_k^\dagger).

Commute a_k and e^{-B} :

$$[B, a_k] = [B, \alpha_k c_k + \beta_k d_k] = \begin{cases} -\lambda_k \alpha_k d_k & \text{if } k > 0 \\ \lambda_{-k} \beta_k c_k & \text{if } k < 0 \end{cases}$$

$[B, [B, a_k]] = 0 \rightarrow$ Baker–Campbell–Hausdorff formula gives:

$$a_k \exp(-B) = \exp(-B) (a_k + [B, a_k])$$

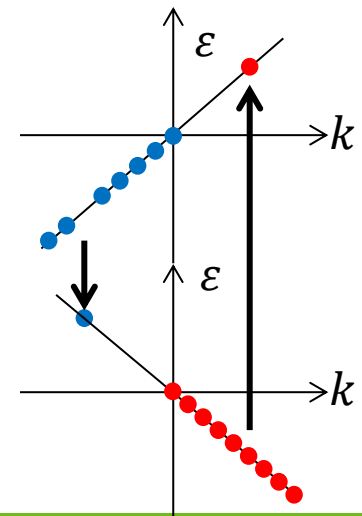

Bulk-edge correspondence in 2d – Free fermion edge (3)

Toy model: free chiral fermions at the edge [Qi, Katsura & Ludwig *et al.* [PRL 2012](#)]

$$[B, a_k] = [B, \alpha_k c_k + \beta_k d_k] = \begin{cases} -\lambda_k \alpha_k d_k & \text{if } k > 0 \\ \lambda_{-k} \beta_k c_k & \text{if } k < 0 \end{cases}$$

So: $a_k \exp(-B) = \exp(-B) \gamma_k$

$$\text{With } \gamma_k = a_k + [B, a_k] = \begin{cases} \alpha_k c_k + \beta_k d_k - \lambda_k \alpha_k d_k & \text{if } k > 0 \\ \alpha_k c_k + \beta_k d_k + \lambda_{-k} \beta_k c_k & \text{if } k < 0 \end{cases}$$

We determine λ_k by requiring that γ_k annihilates $|G_L\rangle \otimes |G_R\rangle$:

$$\gamma_k = \begin{cases} \alpha_k c_k + \beta_k d_k - \lambda_k \alpha_k d_k & \text{if } k > 0 \\ \alpha_k c_k + \beta_k d_k + \lambda_{-k} \beta_k c_k & \text{if } k < 0 \end{cases}$$

(note that the 2 conditions above are equivalent since $\alpha_k = \beta_{-k}$)

$$\lambda_k = \frac{\beta_k}{\alpha_k} = \frac{E_k - vk}{E_k + vk} = \frac{\sqrt{(E_k)^2 - (vk)^2}}{E_k + vk} = \frac{\Delta}{E_k + vk}$$

Final expression for the ground-state:

$$|G\rangle = \exp\left(-\sum_{k>0} \frac{\Delta}{E_k + vk} (c_k^\dagger d_k + d_{-k}^\dagger c_{-k})\right) |G_L\rangle \otimes |G_R\rangle$$

Reduced density matrix for the L-edge ?

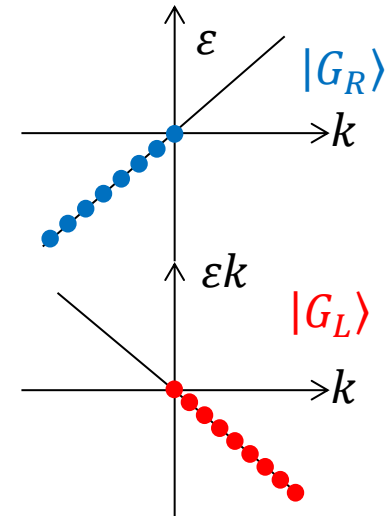

Bulk-edge correspondence in 2d (5)

Toy model: free chiral fermions at the edge [Qi, Katsura & Ludwig *et al.* [PRL 2012](#)]

$$|G\rangle = \exp\left(-\sum_{k>0} \frac{\Delta}{E_k + vk} (c_k^\dagger d_k + d_{-k}^\dagger c_{-k})\right) |G_L\rangle \otimes |G_R\rangle$$

Remark: modes with different k are independent, and all the terms in the exponential above commute with each other.

$$|G\rangle = \prod_{k>0} (1 - \lambda_k c_k^\dagger d_k) |1\rangle_{k,L} |0\rangle_{k,R} \prod_{k>0} (1 - \lambda_k d_{-k}^\dagger c_{-k}) |0\rangle_{-k,L} |1\rangle_{-k,R}$$

$$|G\rangle = \prod_{k>0} (|1\rangle_{k,L} |0\rangle_{k,R} - \lambda_k |0\rangle_{k,L} |1\rangle_{k,R}) \prod_{k>0} (|0\rangle_{-k,L} |1\rangle_{-k,R} - \lambda_k |1\rangle_{k,L} |0\rangle_{k,R})$$

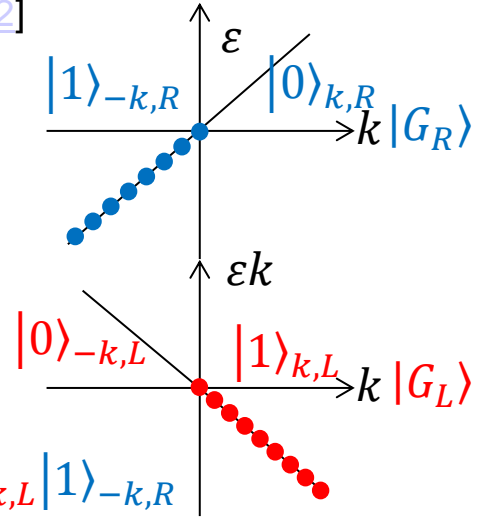

Normalize -> Schmidt decomposition :

$$|G\rangle = \prod_{k>0} \left(\frac{1}{\sqrt{1 + (\lambda_k)^2}} |1\rangle_{k,L} |0\rangle_{k,R} - \frac{\lambda_k}{\sqrt{1 + (\lambda_k)^2}} |0\rangle_{k,L} |1\rangle_{k,R} \right) \prod_{k>0} \left(\frac{1}{\sqrt{1 + (\lambda_k)^2}} |0\rangle_{-k,L} |1\rangle_{-k,R} - \frac{\lambda_k}{\sqrt{1 + (\lambda_k)^2}} |1\rangle_{k,L} |0\rangle_{k,R} \right)$$

Bulk-edge correspondence in 2d (6)

Toy model: free chiral fermions at the edge [Qi, Katsura & Ludwig *et al.* [PRL 2012](#)]

Schmidt decomposition :

$$|G\rangle = \prod_{k>0} \left(\frac{1}{\sqrt{1+(\lambda_k)^2}} |1\rangle_{k,L} |0\rangle_{k,R} - \frac{\lambda_k}{\sqrt{1+(\lambda_k)^2}} |0\rangle_{k,L} |1\rangle_{k,R} \right) \prod_{k>0} \left(\frac{1}{\sqrt{1+(\lambda_k)^2}} |0\rangle_{-k,L} |1\rangle_{-k,R} - \frac{\lambda_k}{\sqrt{1+(\lambda_k)^2}} |1\rangle_{-k,L} |0\rangle_{-k,R} \right)$$

Reduced density matrix for the L -edge:

$$\rho_L = \prod_{k>0} \frac{1}{1+(\lambda_k)^2} (|0\rangle\langle 0|_{k,R} + (\lambda_k)^2 |1\rangle\langle 1|_{k,R}) \prod_{k>0} \frac{1}{1+(\lambda_k)^2} (|1\rangle\langle 1|_{-k,R} + (\lambda_k)^2 |0\rangle\langle 0|_{-k,R})$$

$$\rho_L = \prod_{k>0} \frac{1}{1+(\lambda_k)^2} \exp(\log((\lambda_k)^2) c_k^\dagger c_k) \prod_{k>0} \frac{1}{1+(\lambda_k)^2} \exp(\log((\lambda_k)^2) c_{-k} c_{-k}^\dagger)$$

Expand for $|k| \rightarrow 0$: $\lambda_k = \frac{\Delta}{E_k + vk} \approx \frac{1}{1 + \frac{vk}{\Delta}} \approx 1 - \frac{vk}{\Delta} \rightarrow \log((\lambda_k)^2) \approx -2 \frac{vk}{\Delta}$

$$\rho_L \sim \prod_{k>0} \exp\left(-2 \frac{vk}{\Delta} (c_k^\dagger c_k + c_{-k} c_{-k}^\dagger)\right) = \prod_{k>0} \exp\left(-2 \frac{vk}{\Delta} (c_k^\dagger c_k - c_{-k}^\dagger c_{-k} + 1)\right)$$

$$= \prod_k \exp\left(-2 \frac{vk}{\Delta} c_k^\dagger c_k + cst.\right) \sim \exp\left(-\frac{2}{\Delta} H_L\right)$$

→ The L -edge is seen at some effective temperature $\frac{\Delta}{2}$.

Bulk-edge correspondence & spin ladders

Spin ladder model

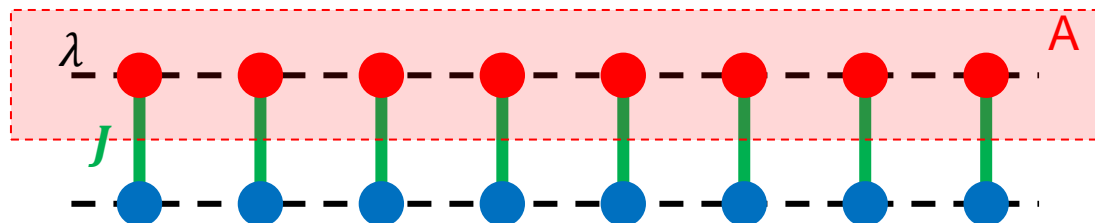

“Entanglement Spectra of Quantum Heisenberg Ladders”,
D. Poilblanc, *Phys. Rev. Lett.* **105**, 077202 (2010).

➤ Numerical observation: the ES of **A** (upper chain) is very similar to the (energy) spectrum of the Heisenberg spin- $\frac{1}{2}$ **chain**.

NB: Des Cloizeaux Pearson [1962] dispersion relation for a single chain:
 $\epsilon_k = \frac{\pi}{2} |\sin k|$.

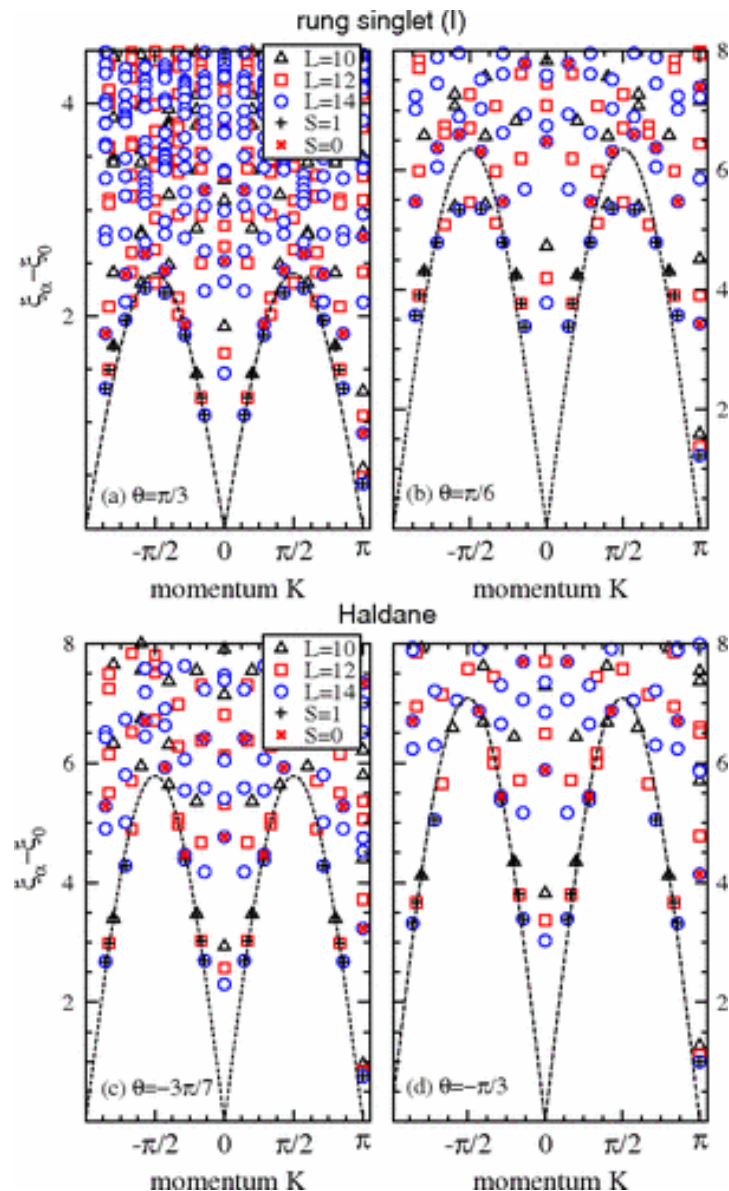

Bulk-edge correspondence & spin ladders

- “On the relation between entanglement and subsystem Hamiltonians”, I. Peschel and M.-C. Chung, [EPL 96, 50006 \(2011\)](#).

Idea: compute the entanglement spectrum (of the region A) *perturbatively* in λ .

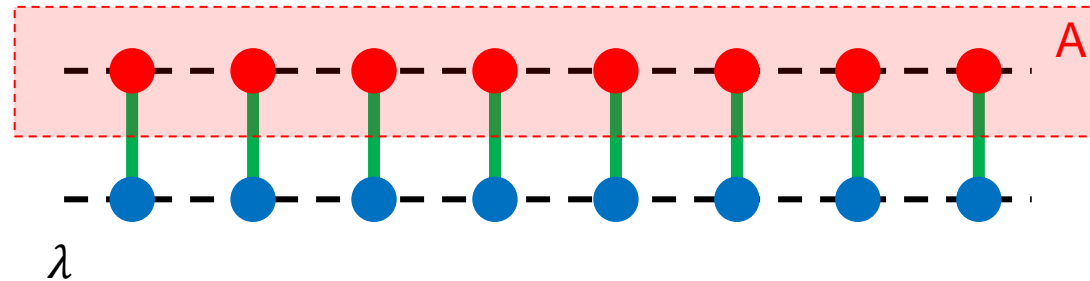

$$J \quad H = J \sum_{i=1 \dots L} \vec{S}_{i a} \cdot \vec{S}_{i b} + \lambda (H_A + H_B)$$
$$H_A = \sum_i \vec{S}_{i a} \cdot \vec{S}_{i+1 a} \quad H_B = \sum_i \vec{S}_{i b} \cdot \vec{S}_{i+1 b}$$

Topological entanglement entropy in 2d (1)

“Topological Entanglement Entropy”

Alexei Kitaev and John Preskill

[Phys. Rev. Lett. 96, 110404 \(2006\)](#)

“Detecting Topological Order in a Ground State Wave Function”

Michael Levin and Xiao-Gang Wen

[Phys. Rev. Lett. 96, 110405 \(2006\)](#)

“Quasiparticle statistics and braiding from ground-state entanglement”

Y. Zhang, T. Grover, A. Turner, M. Oshikawa, and A. Vishwanath

[Phys. Rev. B 85, 235151 \(2012\)](#)

Topological entanglement entropy in 2d (2)

- Assume that the (low- “energy” part of the) entanglement spectrum is described by the 1d gapless Hamiltonian describing gapless edge modes [Qi-Katsura-Ludwig argument]: $\rho_A \sim \exp(-H)$ and $H = H_{edge} \simeq H_{CFT}$ is gapless and describe a 1d quantum system of length L .

- As usual, to compute the entanglement entropy we write $\text{Tr}[\rho_A^n] = \frac{Z_a(L,n)}{Z_a(L,1)^n}$ with $Z_a(L,n) = \text{Tr}[e^{-nH_a(L)}]$. $Z_a(L,n)$ is a CFT partition function on a torus of size $n \times L$. Here n plays the role of an imaginary time (with respect to $H_a(L)$).

- We are interested in $L \rightarrow \infty$ and n fixed, so it is convenient to invert the space and (imaginary) time directions using a (CFT) modular transformation:

$$Z_a(L,n) = \sum_b S_a^b Z_b(n,L) \text{ with } S: \text{ modular matrix of the CFT}$$

- Since the “time” dimension L now goes to ∞ , we can approximate the partition function $Z_b(n,L)$ by the contribution of the ground state of $H_b(n)$:

$$Z_b(n,L) \simeq \exp(-LE_b(n)).$$

- The lowest energy is expected in the “trivial” sector $b=1$. Standard finite-size correction to the energy in CFT gives: $E_1(n) = e_0 \times n + \frac{\pi c}{6n} + \sigma \left(\frac{1}{n}\right)$, where e_0 is the (non-universal) ground-state energy.

- We get: $Z_a(L,n) \simeq S_a^1 \exp\left(-L \times e_0 \times n - L \frac{\pi c}{6n} + L \sigma \left(\frac{1}{n}\right)\right)$ and

$\log \text{Tr}[\rho_A^n] = (1-n) \log S_a^1 + \mathcal{O}(L)$. We thus have a constant term $\log S_a^1$ in the Rényi entropies (+plus the area law $\mathcal{O}(L)$). If $a=1$ (ground state sector), we find $S_1^1 = 1/\mathcal{D}$ where \mathcal{D} is the so-called **total quantum dimension** of the CFT. It is related to the fractional excitation content of the phase.

- Finally, the universal piece in the entanglement entropy reads $S_A = \mathcal{O}(L) - \log \mathcal{D}$

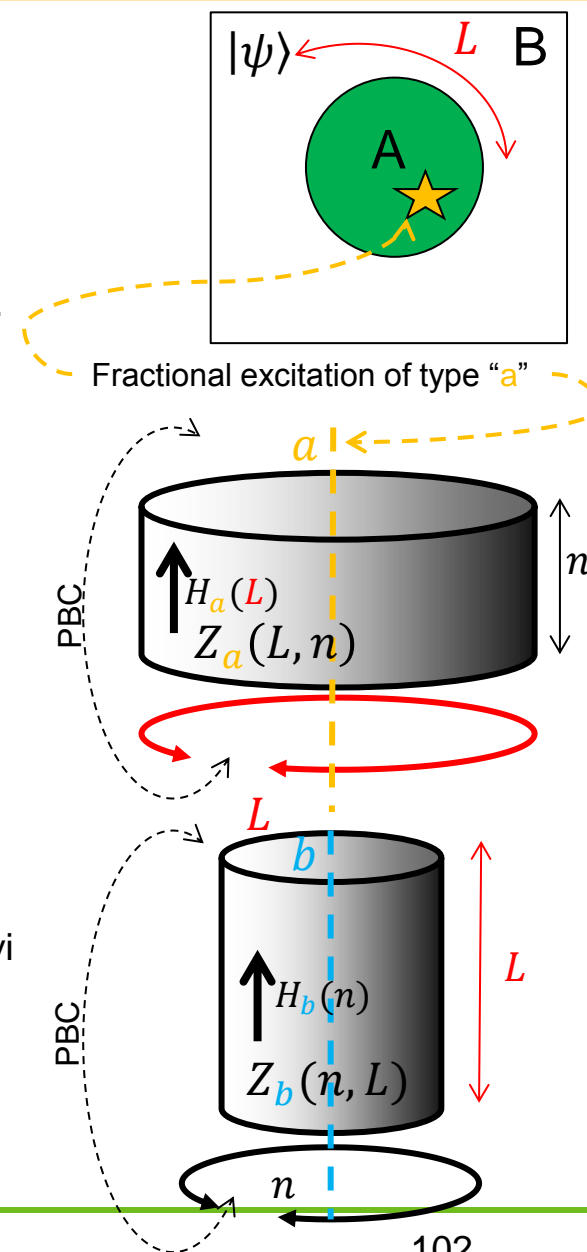

Area law in 2d – fractional quantum Hall states

“Entanglement scaling of fractional quantum Hall states through geometric deformations”

A. M. Lauchli, E. Bergholtz, M. Haque,
[New Jour. of Phys, 12, 075004 \(2010\)](#)

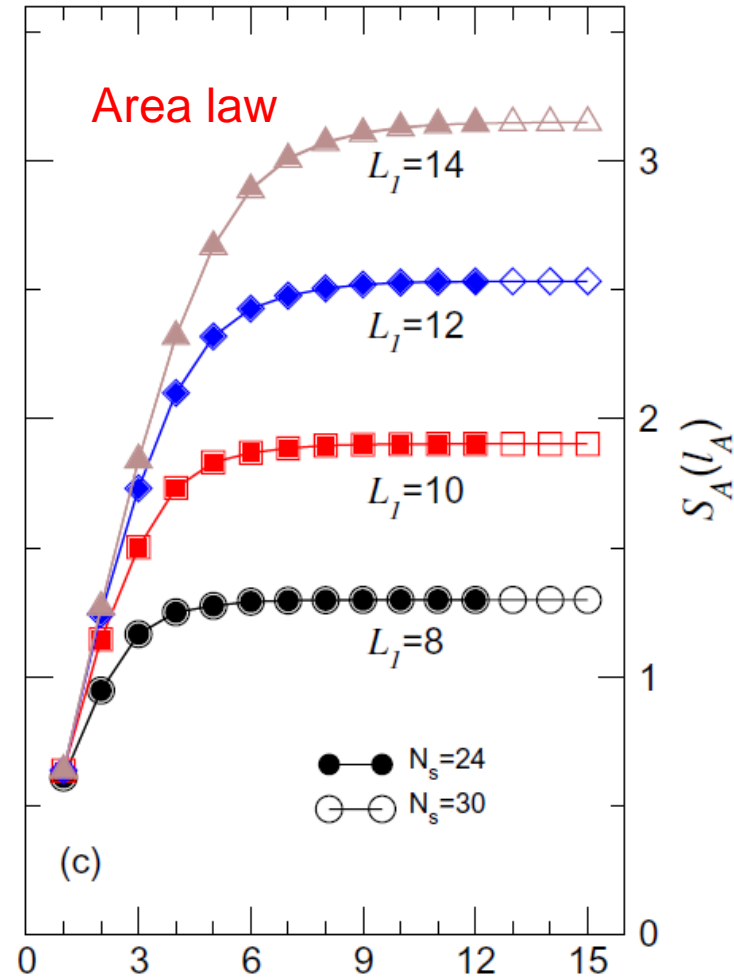
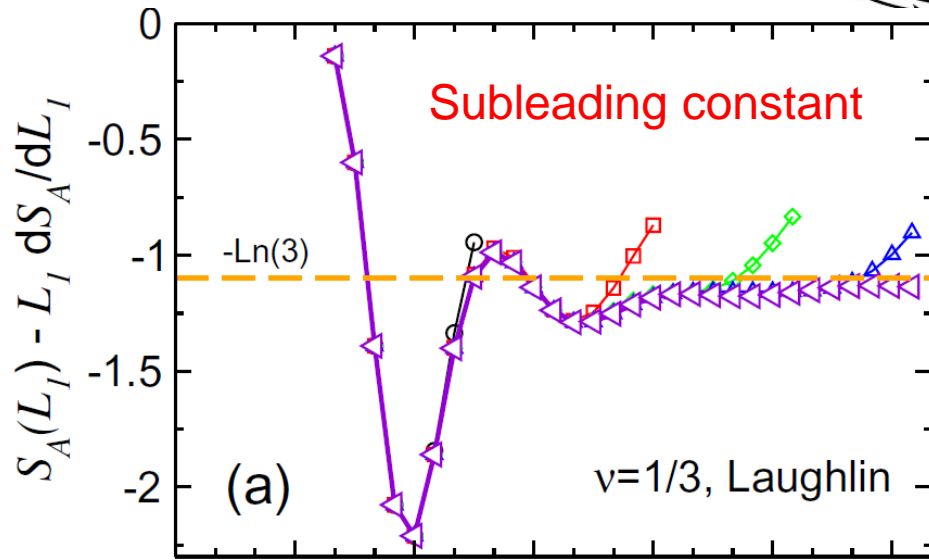

$\mathcal{D} = \sqrt{m}$ is the total quantum dimension for a Laughlin state at filling fraction $\nu = \frac{1}{m}$ (m odd integer). In the torus geometry, the topological entanglement entropy is *twice* that of a disk, hence $-2\log(\mathcal{D}) = -2\log\sqrt{3} = -\log 3$ in the example above.

-
- ❑ Thanks to Vincent Pasquier for numerous discussions on these topics
 - ❑ All the slides are online:
 - Home page: <http://ipht.cea.fr/Pisp/gregoire.misguich>
 - or
 - <http://ipht.cea.fr>
Cours / Programme des cours de l'année académique / « Quantum entanglement... »
 - ❑ Comments & questions are very welcome
 - ❑ Thank you !