

# Planar Log-periodic Antenna Array for Millimetric 5G Band

A. Venouil<sup>1</sup>, M. Benwadih<sup>2</sup>, C. Serbutoviez<sup>2</sup>, P. Pannier<sup>1</sup>, and M. Egels<sup>1</sup>

<sup>1</sup>Aix Marseille University, CNRS, IM2NP, Marseille, France

<sup>2</sup>University Grenoble Alpes, CEA, LITEN, Grenoble 38000, France

**Abstract**— The article presents a fully planar antenna array that is wideband, high gain, and usable at millimeter wave 5G frequencies. The article details the design process and measurement results, with the antenna shown to have stable and high measured gain averaging 10.27 dB over the 24–28 GHz band of 5G. The antenna array is made by laser-etching on Taconic RF-35 substrate, achieving compact size of  $30.0\text{ mm} \times 26.3\text{ mm} \times 0.250\text{ mm}$ . The fully planar antenna is compatible with multiple low-cost realization processes and is compatible with IoT 5G applications due to its wideband capabilities and high performance.

## 1. INTRODUCTION

With the introduction of fifth-generation (5G) wireless networks, a new era of communication has begun that requires high-speed data transmission, low latency, and increased network capacity. Antenna technology is a critical component of the 5G infrastructure, as it provides accurate and effective wireless connectivity. As a result, researchers are persistently researching and developing new antenna designs with the aim to meet the 5G requirements [1]. The present article highlights two primary criteria of 5G : achieving high performance and low cost for antenna technology. Due to the shrinking of wavelength at 5G frequencies [2], complex antenna systems like MIMO, array, and beamforming can be used in compact designs [3]. To meet the low-cost requirement of 5G, the presented antenna is fully planar, making it compatible with various realisation processes and additive manufacturing. Furthermore, planar antennas offer several advantages such as low-profile build, easy integration, and mass-production capabilities, allowing them to be used in many applications [4]. The goal of the study is the realisation of a compact fully planar antenna, wideband and high gain, usable at millimeter wave 5G frequencies. This study present the use of antenna array to enhance a Log-Periodic Dipole Array (LPDA) antenna’s performance for the millimeter wave 5G bands. The antennas are designed using the full 3D finite element method simulation software, Ansys HFSS 2020 R2. The presented antenna element, and antenna array are made by laser-etching on a  $250\text{ }\mu\text{m}$  thick Taconic RF-35 substrate ( $\epsilon_r = 3.5$ ,  $\tan \delta = 1.8 \times 10^{-3}$ ). The article first presents the single LPDA and its performance, followed by a detailed explanation of how performance can be improved using antenna array design, which is then realised and measured.

## 2. DESIGN

The design of the antenna array is composed of multiple Log Periodic Dipole Array (LPDA) elements. The first part of the study present the LPDA element, before covering the antenna array. The LPDA antenna topology is selected because of its capacity to cover the 24–28 GHz first millimeter wave band of 5G. The antenna single LPDA antenna element is designed using formulas

Table 1: Dimension and position of the elements of the LPDA antenna.

El. N°	Half length on Taconic RF-35 ( $\epsilon_{\text{reff}} = 2.76$ ) in mm	Distance to previous element on Taconic RF-35 in mm
1	<b>1.74</b>	-
2	<b>1.51</b>	<b>1.12</b>
3	<b>1.29</b>	<b>0.95</b>
4	<b>1.12</b>	<b>0.84</b>
5	<b>1.01</b>	<b>0.728</b>
6	<b>0.84</b>	<b>0.616</b>

available in literature from [5, 6]. The main parameters of the design are  $\tau$  and  $\sigma$ , respectively,  $\tau$  is the ratio between two successive elements of the antenna and  $\sigma$  is the relative spacing between two successive elements.  $\tau$  and  $\sigma$  are chosen for the single LPDA antenna to be matched in the band 24–28 GHz. To cover the 24–28 GHz band, on a  $250\mu\text{m}$  thick Taconic RF-35 substrate, simulation have shown that a minimum of 5 or 6 element are needed. The dimensions of the single LPDA antenna is detailed in Fig. 1 and Table 1.

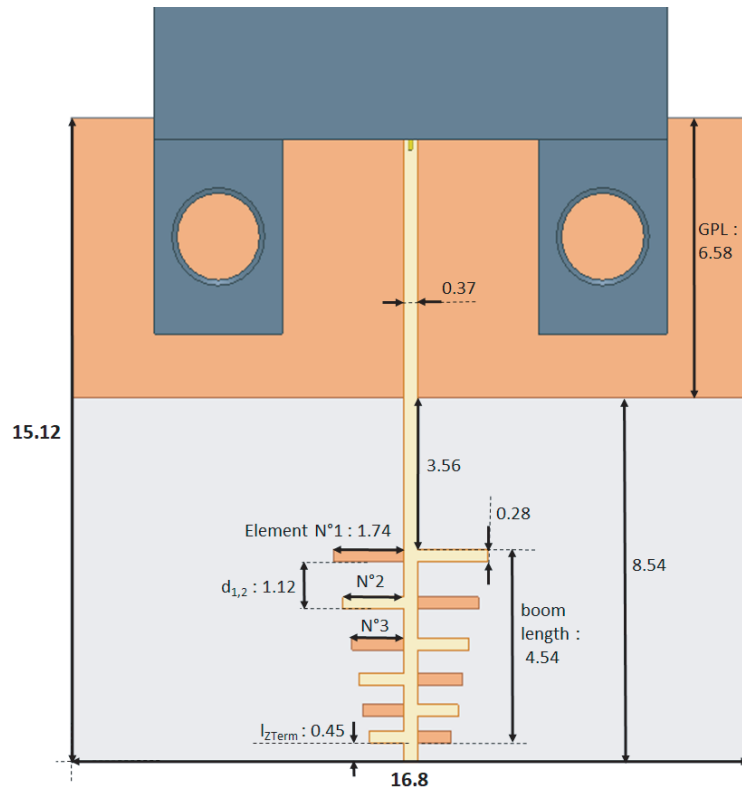

Figure 1: Description and dimensions of the single LPDA antenna in millimeters.

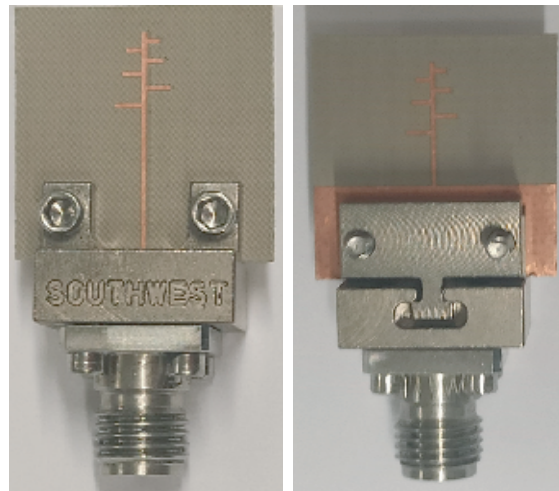

Figure 2: Photographs of the realized single LPDA antenna.

The single LPDA antenna is realized by laser etching and measured on a free space measurement test bench.  $S_{11}$  and gain measurements of the designed LPDA constitutive of the array are presented in Figs. 3–4. Measurement of the single element show a bandwidth of 24.4 to 28.4 GHz, and an average gain of 6.8 dB.

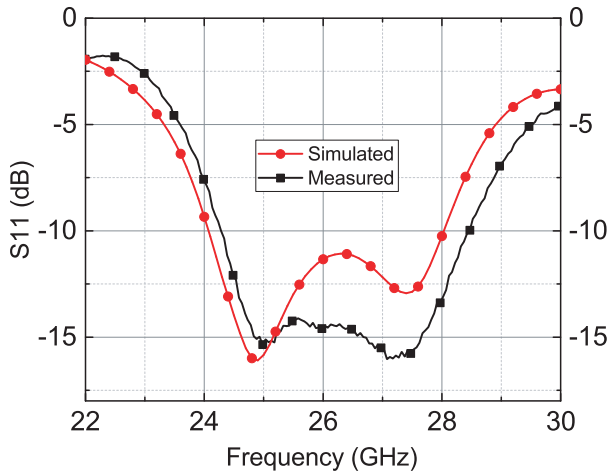

Figure 3:  $S_{11}$  measurement and simulation of a single LPDA antenna.

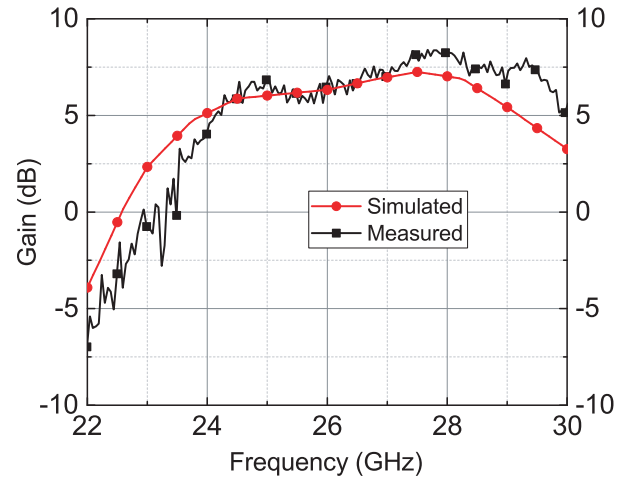

Figure 4: Gain measurement and simulation of a single LPDA antenna.

To design an antenna array, two steps are necessary: the design of the feeding network of the array. Second, the spacing between the array elements has to be determined.

Regarding the first step, the selected feeding network is based on T-junction power dividers because T-junction power divider are easier to design than other power divider. Each element of the array is to be fed in phase. Multiple topologies of T-junction power divider exist in literature. (resistive, quarter wave transformer). It is not possible to obtain a perfectly matched, lossless and reciprocal T-junction power divider [7]. Matching the feed (port 1) and minimizing transmission

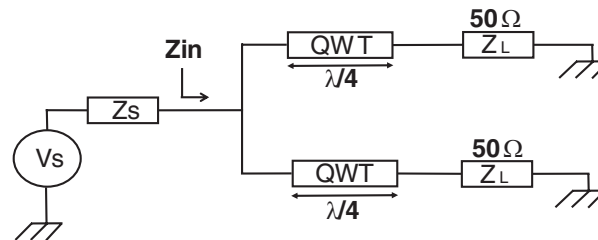

Figure 5: General schematic of a 1 to 2 T-junction power divider using quarter wave transformers.

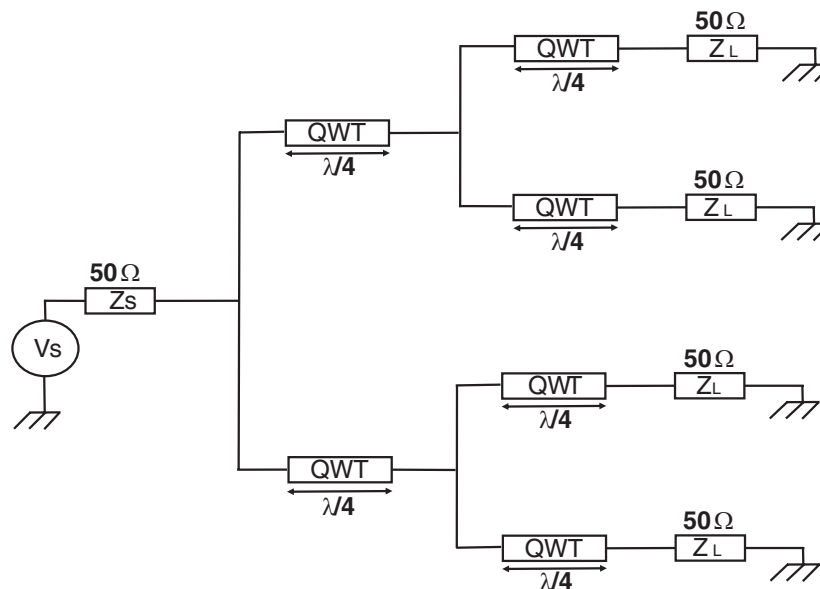

Figure 6: Schematic of a 1-to-4 T-junction power divider used in this article.

losses, cause degraded matching on ports 2–5. The general topology of a quarter wave transformer based T junction power divider is shown in Fig. 5. A 1-to-4 power divider can be designed by cascading three 2-way power dividers. Fig. 6 presents a schematic of a 1-to-4 transformer topology. The 1-to-4 power divider topology is used to feed the designed antenna array. The 1-to-4 power divider is designed using ADS momentum and the transmission and reflection S-parameters are presented in Figs. 7, 8.

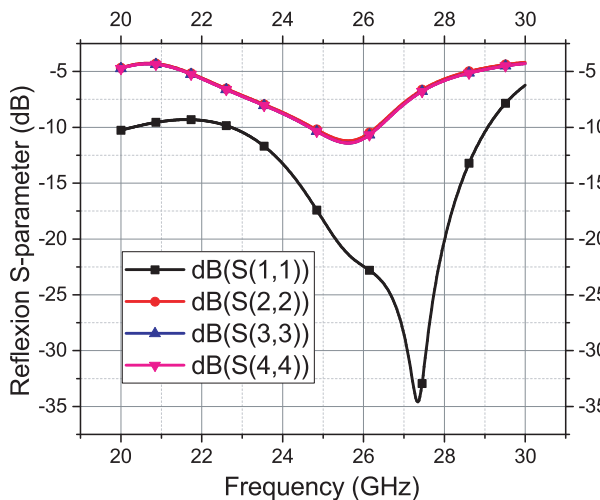

Figure 7: Reflection coefficient of the a 1-to-4 T-junction power divider.

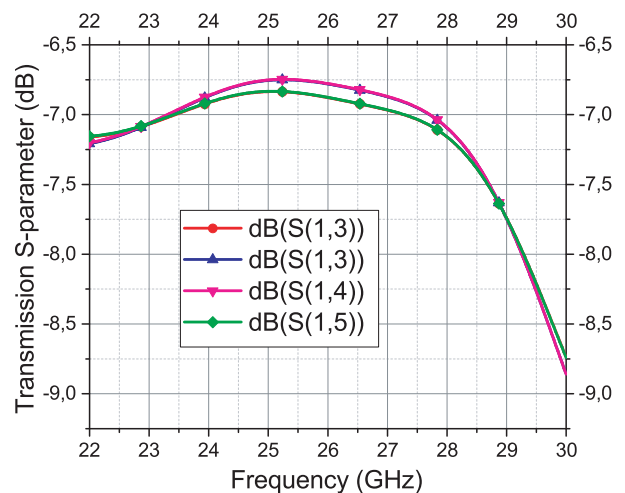

Figure 8: Transmission coefficient of the 1-to-4 T-junction power divider.

The spacing between array elements is a main parameter in the calculation of the array factor [8]. For a linear array of end-fire antenna with uniform distribution, the spacing can not be higher than  $\lambda/2$  [9]. By selecting a spacing higher than  $\lambda/2$ , the apparition of null in the array factor cause the apparition of unwanted secondary lobes. Antennas are positioned as in-phase antenna array, spaced by  $\lambda/2$  (6.15 mm at 26 GHz).

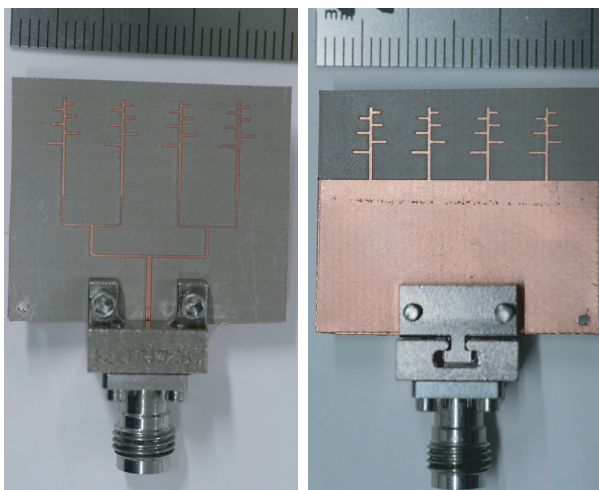

Figure 9: Photographs of the front-side and back-side of the antenna array.

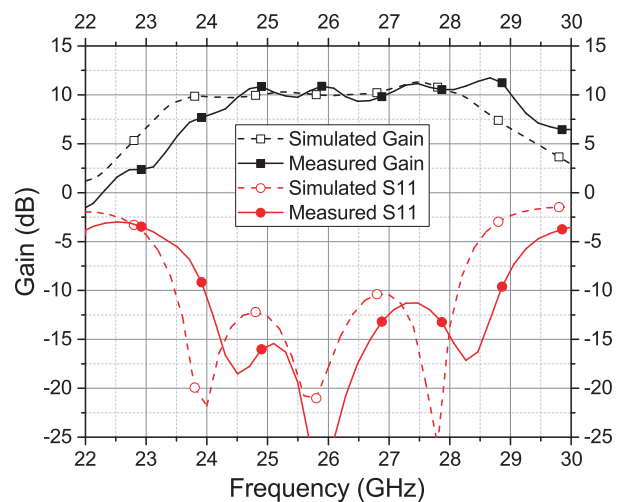

Figure 10: Measured and simulated  $S_{11}$  and gain of the antenna array.

### 3. REALISATION AND MEASUREMENTS

The designed antenna array is manufactured by laser etching and measured on a free space measurement test bench. The size of the realized antenna is 30.0 mm  $\times$  26.3 mm  $\times$  0.250 mm. Photographs of the realized antenna array is presented in Fig. 9, and measurements of the  $S_{11}$  and gain are presented in Fig. 10. The antenna is matched from 24.0 to 28.8 GHz. The fractional bandwidth is 18.4%. The peak measured gain 11.73 dB, and the average measured gain over the band is 10.27 dB.

The minimal measured front to back ratio is 17.41 dB with an average of 19.28 dB. The side lobe level (SLL) has a minimal measured value of 13.9 dB over the frequency band. The measured  $E$ -plane and  $H$ -Plane radiation patterns are presented in Figs. 11, 12.

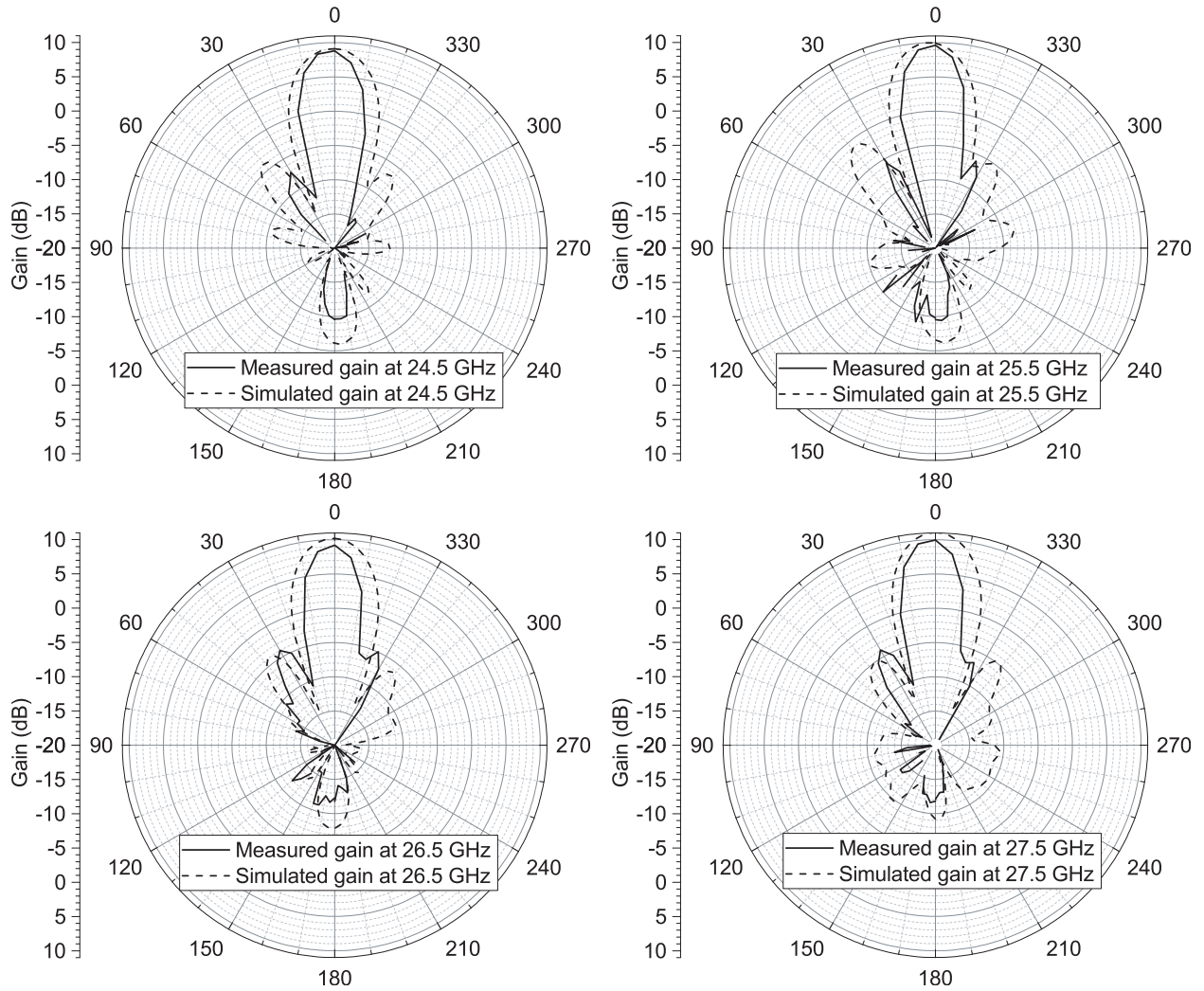
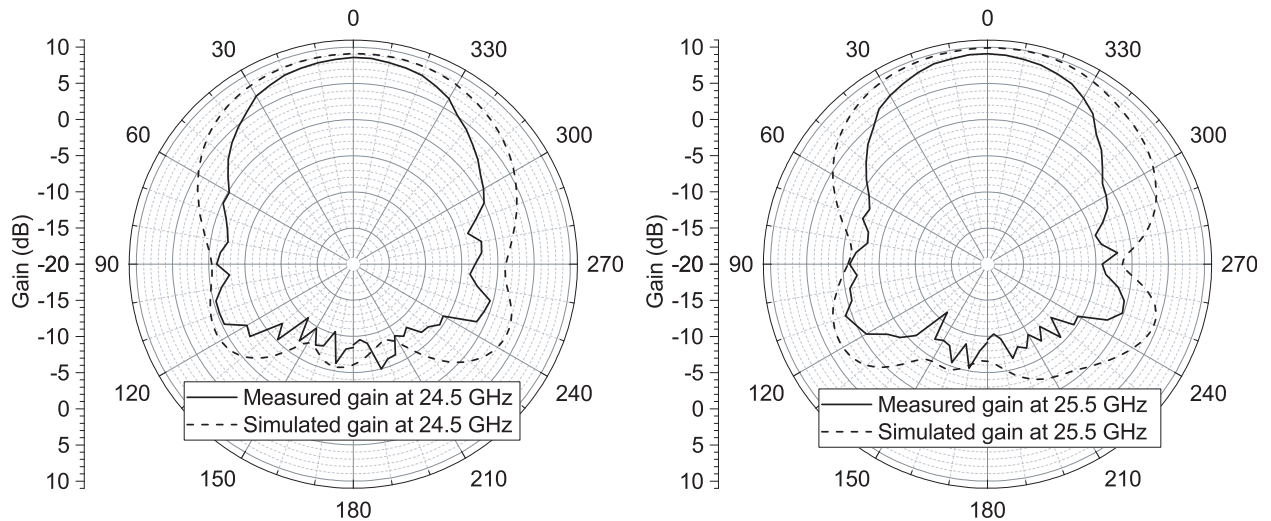

Figure 11: Measured and simulated  $E$ -plane.



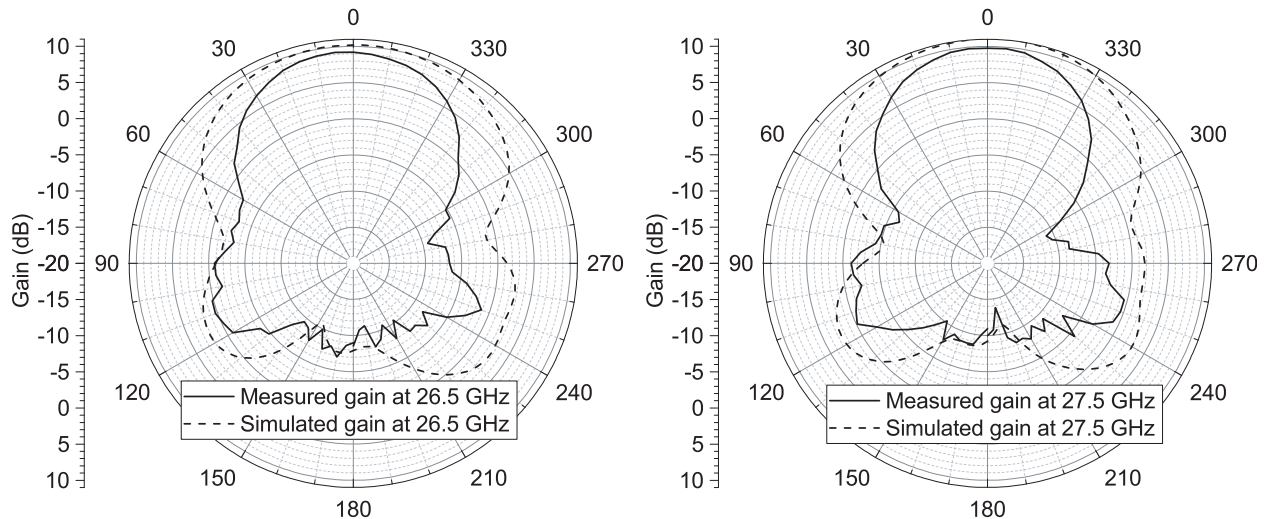

Figure 12: Measured and simulated  $H$ -plane.

#### 4. CONCLUSION

A wideband antenna covering the 24.0–28.8 GHz 5G band has been successfully designed, realized and measured. The method of design has been described in detail, and the antenna has been shown to have stable and high gain averaging 10.27 dB, which closely matches simulation results. With a compact size of 30.0 mm  $\times$  26.3 mm  $\times$  0.250 mm and only two metallic layers, this fully planar antenna is compatible with multiple low-cost realization processes. It is an ideal choice for IoT 5G applications due to its wideband capabilities and high performance.

#### REFERENCES

1. Ding, A. Y. and M. Janssen, “Opportunities for applications using 5G networks: Requirements, challenges, and outlook,” *Proceedings of the Seventh International Conference on Telecommunications and Remote Sensing*, 27–34, ACM, Barcelona Spain, 2018.
2. “Global update on 5G spectrum,” *Qualcomm.*, 2021.
3. Kumar, S., A. S. Dixit, R. R. Malekar, H. D. Raut, and L. K. Shevada, “Fifth generation antennas: A comprehensive review of design and performance enhancement techniques,” *IEEE Access*, Vol. 8, 163568–163593, 2020.
4. Wong, K. L., *Planar Antennas for Wireless Communications*, John Wiley & Sons, Hoboken, 2003.
5. League, A. R. R., *The A. R. R. L. Antenna Book*, American Radio Relay League, 1982.
6. Stroobandt, S. and M. McCue, “Log-Periodic dipole array calculator,” *Online*, 2017, <https://hamwaves.com/lpda/en/index.html>.
7. Pozar, D. M., *Microwave Engineering*, 4th Edition, Wiley, 2011.
8. Kummer, W. H., “Basic array theory,” *Proceedings of the IEEE* 80, 127–140, Jan. 1992.
9. Balanis, C. A., *Antenna Theory: Analysis and Design*, Wiley-Interscience, 2005.