



HAL
open science

Planar Quasi Log Periodic Dipole Antenna for Millimeter Wave 5G Band

A. Venouil, Matthieu Egels, M. Benwadih, C. Serbutoviez, P. Pannier

► **To cite this version:**

A. Venouil, Matthieu Egels, M. Benwadih, C. Serbutoviez, P. Pannier. Planar Quasi Log Periodic Dipole Antenna for Millimeter Wave 5G Band. 2023 17th European Conference on Antennas and Propagation (EuCAP), Mar 2023, Florence, France. pp.1-4, 10.23919/EuCAP57121.2023.10133715 . hal-04441744

HAL Id: hal-04441744

<https://hal.science/hal-04441744>

Submitted on 9 Feb 2024

HAL is a multi-disciplinary open access archive for the deposit and dissemination of scientific research documents, whether they are published or not. The documents may come from teaching and research institutions in France or abroad, or from public or private research centers.

L'archive ouverte pluridisciplinaire **HAL**, est destinée au dépôt et à la diffusion de documents scientifiques de niveau recherche, publiés ou non, émanant des établissements d'enseignement et de recherche français ou étrangers, des laboratoires publics ou privés.

Planar Quasi Log Periodic Dipole Antenna for Millimeter Wave 5G Band

A. Venouil*, M. Egels*, M. Benwadih†, C. Serbutoviez† P. Pannier*

*Aix Marseille Univ, CNRS, IM2NP, Marseille France

†University Grenoble Alpes, CEA, LITEN, 38000 Grenoble, France

contact: anton.venouil@im2np.fr

Abstract—This article present the design and measurement of a planar quasi log periodic antenna covering the first millimeter band of 5G (24.25 GHz - 28.4 GHz). The antenna is conceived using HFSS and realized using laser etching on Taconic RF-35 substrate. A modification of the topology is applied to obtain a vialess antenna. The proposed antenna is easier to manufacture than most 5G antenna available with comparable results. The antenna present an measured average gain of 6.85 dB over the first millimetric 5G band.

Index Terms—antennas, electromagnetism, LPDA, log periodic, planar, 5G, wideband, millimetric, millimeter wave.

I. INTRODUCTION

The development of 5G is already taking place to meet the currently growing data traffic and future requirements for IoT. Gigahertz 5G bands are already commercialized in multiple countries. Applications and systems for millimeter bands of 5G (24-28.5 GHz and higher) are still developed in research and industry. An important issue of microwave communications is the prevalence of atmospheric attenuation. 5G millimeter-wave communication relies on high gain antenna and MIMO configuration. In literature, the main method applies to obtain high gain is the use of array, with the drawback of limiting multi-path applications [1].

With some exception (Japan and Korea up to 29.5 GHz) every country allocated the 24 GHz - 28.5 GHz band [2]. The usual relative bandwidth of wideband antennas is around 0.2 (or 20%) and is able to cover the 24 GHz - 28.5 GHz band. Multiple topologies of antennas are available for wideband 5G band frequency, but the requirement for high gain [3] limits possibilities for planar antenna design. Fractal antenna are suitable but complex to design and manufacture at millimeter wave frequencies. The two main antenna topologies in research are Yagi-Uda and Log Periodic Dipole Antennas (LPDA). On the comparison of Yagi and LPDA for 5G, literature review relate an advantage of gain for the Yagi antenna at the cost of bandwidth. For example, 6 elements (4 directors) Yagi antenna shows up to 10.2 dB [4], against around 7.6 dB (using formulas given in [5]) for a 6-dipole log periodic antenna, but with 3% bandwidth against 20% for LPDA. Similar conclusions are shown in [6]. Another point of comparison is the compatibility of use for MIMO systems. A drawback of Yagi antenna is the use of parasitic elements, which increase complexity of the standard methods of isolation between port in MIMO system [7]. Also, stronger side lobe level due to parasitic

element could impact MIMO performance [8] [9]. In contrast, LPDA present lower sidelobe level as being based on dipole elements instead of parasitic and a lower front to back ratio [6]. Both Yagi and LPD antennas have advantages and drawback. Published research on existing Log Periodic Antennas, shows multiple studies for 5G antennas as in the comparison table in [10] from 2021. Thanks to the very wideband characteristic of LPDA, the majority of publications aim to cover both 24.5 GHz - 28.35 GHz and 37 GHz - 40 GHz frequency bands [11] [12] [13]. In our publication, the design is focused on 24.5 GHz - 28.35 GHz with modification of the topology. The prefix "quasi" is used to describe the modifications made to the conventional topology of LPDA (Log Periodic Dipole Antenna) to render it fully planar. A fully planar topology are privileged for large scale production, which is one of the main challenges for antennas in MIMO system [14]. Fully planar topologies are also appropriate for printing process, and the use of flexible substrates. The drawback is the reduction of bandwidth, which for a LPDA an acceptable trade-off due to initially large bandwidth (>40%). The antenna is realized by laser etching on a low cost Taconic RF-35 Substrate ($\epsilon_r = 3.5$, $\tan\delta = 3.5 \times 10^{-3}$ @25 GHz, $h=0.25\text{mm}$) and compared to HFSS simulation. It operates with -10 dB bandwidth from 24.2 GHz to 28.4 GHz. The average measured gain over the band is 6.85 dB and the peak value 8.39 dB.

II. DESIGN AND SIMULATION

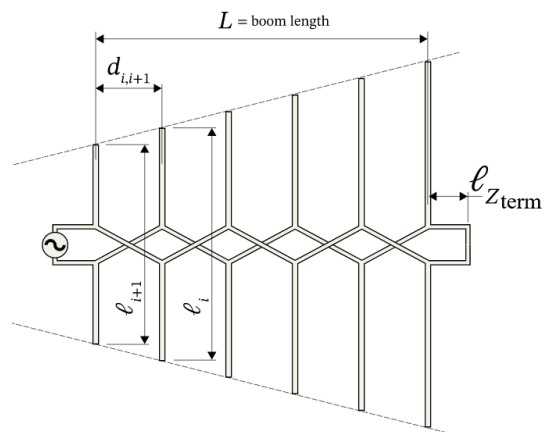

Fig. 1. Classic LPDA Antenna.

TABLE I
ACRONYMS USED IN DESIGN OF LPDA ANTENNA

Name	symbol
relative operating bandwidth	B
optimal spacing	σ_{opt}
cotangent of the apex half-angle	cot
relative bandwidth of the active region	B_{ar}
relative bandwidth of the structure	B_S
number of elements, rounded to an integer	N
boom length	L
length* of dipole element i	l_i
distance between element centres i and $i + 1$	$d_{i,i+1}$
length of the terminating stub† Z_{term}	$l_{Z_{term}}$

The presented design of planar LPDA is based on the same formulas as the design of 3D LPDA. The formulas from [5] (originally introduced in [15]) are used in a Python program (program also available online at [16]). The equation are shown in Eq. 1-9 and correspond to Fig. 1. Acronyms signification is detailed in Table I.

$$B = \frac{f_n}{f_1} \quad (1)$$

$$\tau \equiv \frac{l_i}{l_{i-1}} \quad 0.8 \leq \tau \leq 0.98 \quad (2)$$

$$\sigma \equiv \frac{d_{1,2}}{\lambda_1} \quad \sigma_{opt} = 0.243 \tau - 0.051 \quad 0.03 \leq \sigma \leq \sigma_{opt} \quad (3)$$

$$\cot \alpha = \frac{4\sigma}{1-\tau} \quad (4)$$

$$B_{ar} = 1.1 + 7.7(1-\tau)^2 \cot \alpha \quad B_S = B \cdot B_{ar} \quad (5)$$

$$N = 1 + \frac{\ln B_S}{\ln \frac{1}{\tau}} \quad c \equiv 299\,792\,458 \frac{m}{s} \quad (6)$$

$$l_1 = \frac{\lambda_1}{2} = \frac{c}{2f_1} \quad l_i = \tau \cdot l_{i-1} \quad l_{tot} = \sum_{i=1}^n l_i \quad (7)$$

$$d_{i,i+1} = \frac{l_i - l_{i-1}}{2} \cot \alpha \quad L = \sum_{i=1}^{n-1} d_{i,i+1} \quad (8)$$

$$l_{Z_{term}} = \frac{\lambda_1}{8} \quad (9)$$

Using the algorithm with $\tau = 0.85$, $f_1 = 24$ GHz, $f_n = 28$ GHz and σ set to σ_{opt} , the value for each elements length and position is calculated and listed later in table II. The value of τ , the ratio between two successive elements length, is chosen at 0.85 to ensure the wideband characteristic of the LPDA antenna. Higher values of τ , at constant element number (and thus constant surface), results in improved gain at the cost of bandwidth. The presented antenna is realized on Taconic RF-35, with a relative permittivity different from the air. The antenna frequencies are modified when realized on Taconic. To account material influence, a scaling factor is applied to the antenna. The scaling factor between an on air antenna and on material is calculated using two equations. First effective

TABLE II
DIMENSION AND POSITION OF THE ELEMENTS OF THE ANTENNA

El. N°	Initial half length in the air ($\epsilon_{reff} = 1$) in mm	Scaled half length on Taconic RF-35 ($\epsilon_{reff} = 2.76$) in mm	Distance to previous element on Taconic RF-35 in mm
1	3.1	1.74	-
2	2.7	1.51	1.12
3	2.3	1.29	0.95
4	2	1.12	0.84
5	1.8	1.01	0.728
6	1.5	0.84	0.616

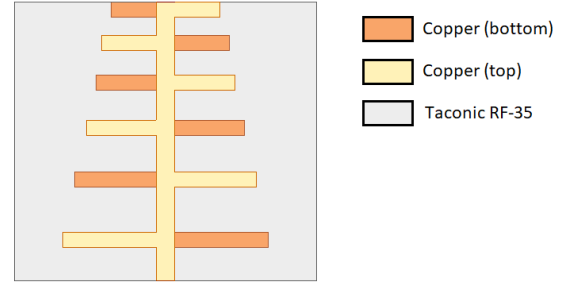

Fig. 2. Preliminary illustration of the antenna.

relative permittivity of Taconic RF-35 is computed with Eq.10, in which $\epsilon_r = 3.5$, $h = 0.25$ mm and $W = 0.6$ mm.

$$\epsilon_{reff} = \frac{\epsilon_r + 1}{2} + \frac{\epsilon_r - 1}{2} [1 + 12 * \frac{h}{W}]^{-1/2} \quad (10)$$

The computed value of ϵ_{reff} on Taconic RF-35 is 2.76.

$$SF = \frac{\lambda_{taconic}}{\lambda_{air}} = \frac{\sqrt{\epsilon_{reff_{air}}}}{\sqrt{\epsilon_{reff_{taconic}}}} \approx \frac{1}{\sqrt{2.76}} \approx 0.6 \quad (11)$$

The initial scaling factor applied to the antenna is 0.6. Further simulation a have set 0.56 as the final scaling factor. In table II is listed the final scaled dimensions of each element of the antenna.

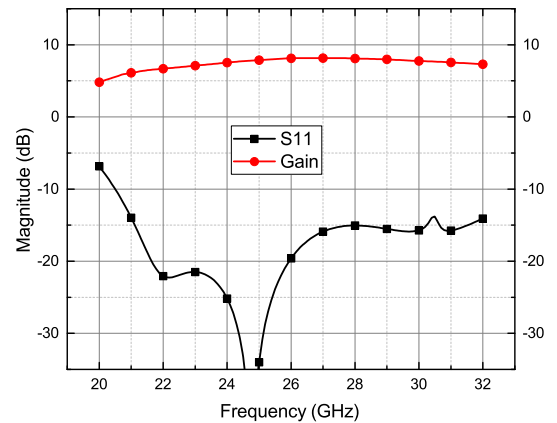
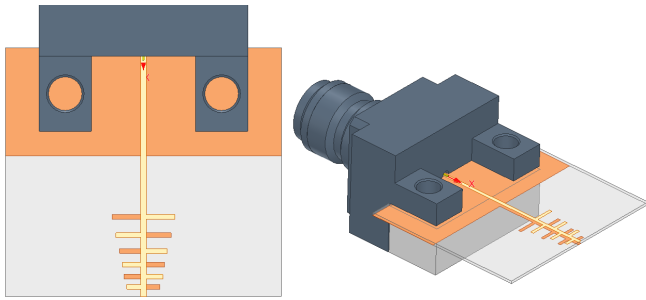

Fig. 3. Initial S11 and Gain of the simulated antenna.



(a) Top view of simulated antenna (b) 3D view of simulated antenna

Fig. 4. Updated antenna simulation model

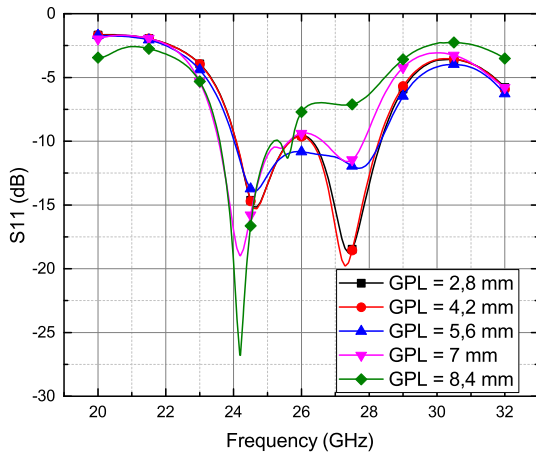

Fig. 5. Optimisation of the ground pattern length.

The full 3D finite element method simulation software, Ansys HFSS 2020 R2, is used to design the proposed LPDA with the previously calculated dimensions. See Fig. 2. Electromagnetic simulations give the results shown in Fig.3. The simulation present good results of gain and S11 over a very wide band. The S11 bandwidth is higher than 40%. This simulated antenna is not realized for two reasons :

- The antenna is not easy to manufacture because of the necessity of a via shorting the top and bottom copper.
- The simulation use 50Ω lumped port and does not represent accurately the real performance.

To avoid the first difficulty, the short stub is modified into an open circuit with a parametric study on the length of the terminating stub. The drawback of this modification is the degradation of the bandwidth. To correct the second issue, an end-Lauch 40 GHz Southwest connectors model is added improve the precision of simulations. After modification, multiple properties of the antenna require tuning. Dimensions of the ground pattern are optimized by parametric simulation as represented in Fig. 5. The goal of the optimization is to maximize gain while maintaining S11 under -10dB over the band. The final selected value of 6.58 mm (11.75 mm, scaled by 0.56) is the best value because a lower value shows an unsatisfying S11 of more than -10dB at 26GHz and higher value reduce bandwidth. With similar method, distance between connector

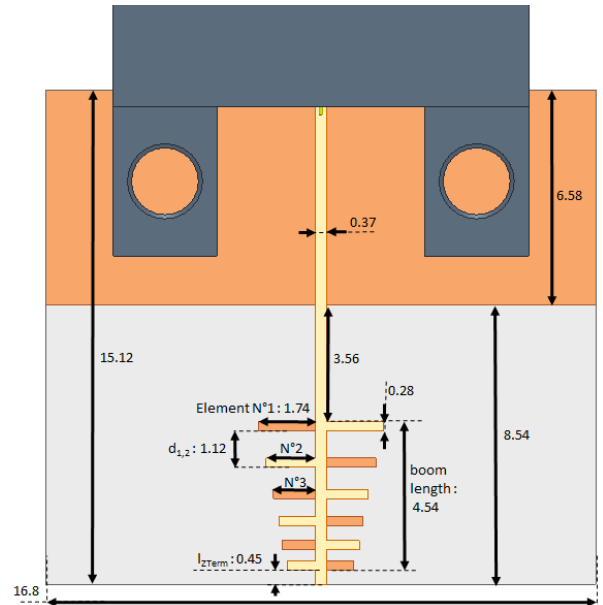
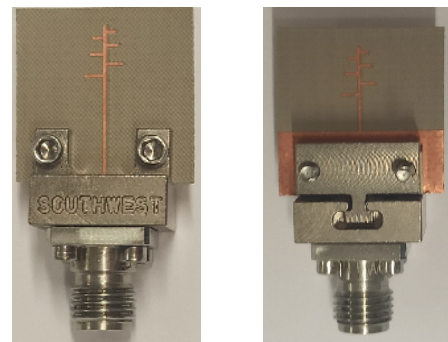

Fig. 6. Final dimensions of the antenna in millimeters.



(a) top side (b) bottom side

Fig. 7. photographs of realized antenna.

and antenna, dimensions of substrate and scaling factor are also optimized without illustration for conciseness. All these optimization results in the final design represented in Fig. 6.

III. MEASUREMENTS AND RESULTS

The antenna is realized on Taconic by laser etching. The selected substrate is a low-cost Taconic RF-35 ($\epsilon_r = 3.5$, $\tan\delta = 3.5 \times 10^{-3}$ @25 GHz). The dimensions of the realized antenna (without connector) is 15.12 mm * 16.8 mm * 0.25 mm. The photographs of realized antenna are presented in Fig. 7. Fig. 8 and Fig. 9 shows the measured versus simulated results of S11 and gain. Simulation and measurements are in agreements. But, measured performance shows a slight shift $\approx 2\%$ against simulation. A probable cause of this shift come from realization accuracy. The measured -10dB bandwidth is 24.2 GHz - 28.4 GHz, leading to a fractional bandwidth 16.1%. Average measured gain over the band is 6.85 dB and peak value 8.39 dB. Fig. 10 present the radiation pattern of the realized antenna.

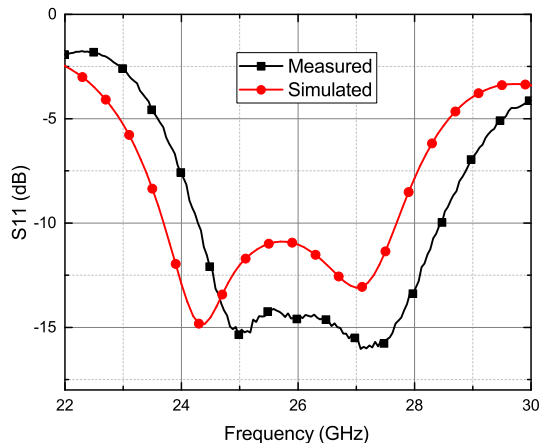

Fig. 8. Measured and simulated S11 of the antenna.

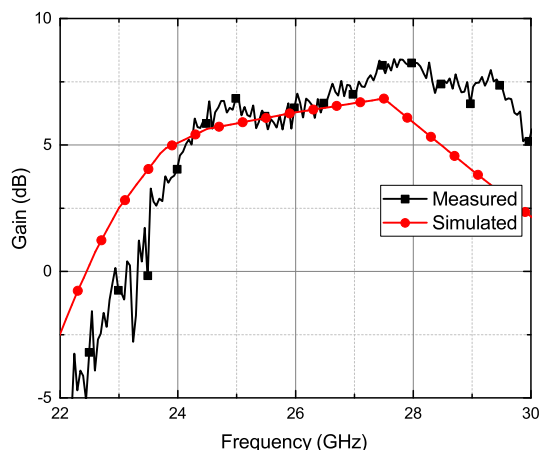

Fig. 9. Measured and simulated gain of the antenna.

IV. CONCLUSION

In this article, the design and realization of a planar quasi log-periodic antenna for the first millimeter band of 5G band (24.25 GHz - 28 GHz) is presented. The antenna measured results shows good agreement on gain and S11 with simulation over the band. The measured -10dB bandwidth is 24.2 GHz - 28.4 GHz, leading to a fractional bandwidth 16.1%. Average measured gain over the band is 6.85 dB and peak value 8.39 dB. The fully planar antenna is compatible with large scale production process. The dimensions of the realized antenna (without connector) is 15.12 mm * 16.8 mm * 0.25 mm. The proposed antenna present similar results with literature. The feasibility of the antenna on flexible materials opens a large panel of applications for 5G. Further study include the possibility of using this antenna as an element of MIMO system.

REFERENCES

[1] J. Khan, S. Ullah, U. Ali, F. A. Tahir, I. Peter, and L. Matekovits, "Design of a millimeter-wave mimo antenna array for 5G communication terminals," *Sensors*, vol. 22, no. 7, p. 2768, 2022.

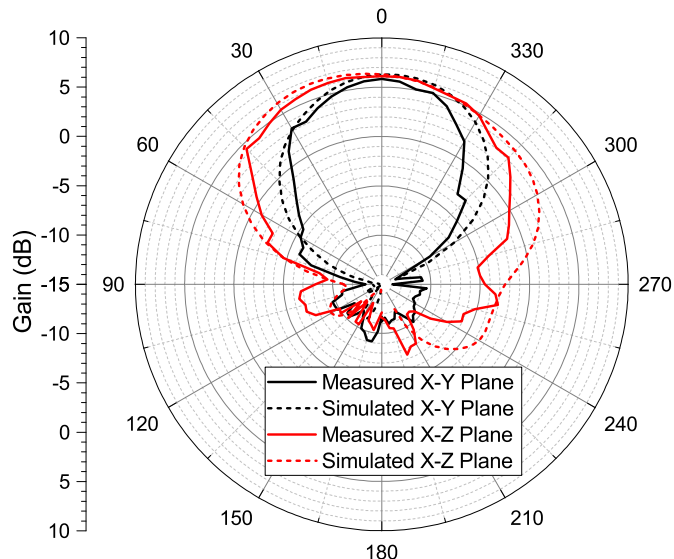

Fig. 10. Measured and simulated radiation pattern of the antenna at 26 GHz, on X-Y plane (teta = 90 deg) and X-Z plane (phi=0).

- [2] "Global update on 5G spectrum." [Online]. Available: <https://www.qualcomm.com/content/dam/qcomm-martech/dm-assets/documents/spectrum-for-4g-and-5g.pdf>
- [3] J. Khan, S. Ullah, U. Ali, F. A. Tahir, I. Peter, and L. Matekovits, "Design of a millimeter-wave mimo antenna array for 5g communication terminals," *Sensors*, vol. 22, no. 7, p. 2768, Apr 2022. [Online]. Available: <http://dx.doi.org/10.3390/s22072768>
- [4] C. A. Balanis, *Antenna theory: analysis and design*. Wiley-Interscience.
- [5] A. R. R. League, *The A. R. R. L. Antenna book*, ser. Radio amateur's library. American Radio Relay League., no. vol. 14, tex.lccn: 57020059.
- [6] B. Mangaraj, S. Mohanty, and S. Hota, "Performance evaluation of two popular antennas designed using a bacteria foraging algorithm," *Engineering Science and Technology, an International Journal*, vol. 19, 09 2016.
- [7] K. Du, Y. Wang, and Y. Hu, "Design and analysis on decoupling techniques for mimo wireless systems in 5g applications," *Applied Sciences*, vol. 12, no. 8, p. 3816, 2022.
- [8] H. Pei, Q. Li, and X. Chen, "Impact of front-to-rear ratio, side lobe level, and beam orientation of base station antennas on mimo performance," in *2020 IEEE 3rd International Conference on Electronic Information and Communication Technology (ICEICT)*, 2020, pp. 607–609.
- [9] D. Uchida, T. Michihata, H. Arai, Y. Inoue, K. Cho, and T. Maruyama, "Optimum beam direction and width for directional antenna indoor mimo systems," 01 2007.
- [10] V. Harini, M. V. S. Sairam, and R. Madhu, "A wide band log periodic millimeter-wave antenna for 5G femtocells applications," *TRANSACTIONS ON EMERGING TELECOMMUNICATIONS TECHNOLOGIES*, vol. 32, no. 11, 2021.
- [11] H. Zhou, N. A. Sutton, and D. S. Filipovic, "Surface micromachined millimeter-wave log-periodic dipole array antennas," *IEEE Transactions on Antennas and Propagation*, vol. 60, no. 10, pp. 4573–4581, 2012.
- [12] R. Kumari, S. Behera, and R. Mishra, "Log Periodic Dielectric Resonator Antenna for K and Ka-band Applications," 05 2011.
- [13] G. Zhai, Y. Cheng, Q. Yin, S. Zhu, and J. Gao, "Uniplanar millimeter-wave log-periodic dipole array antenna fed by coplanar waveguide," *International Journal of Antennas and Propagation*, vol. 2013, 01 2013.
- [14] R. Hussain and M. S. Sharawi, "5G MIMO antenna designs for base station and user equipment: Some recent developments and trends," *IEEE Antennas and Propagation Magazine*, vol. 64, no. 3, pp. 95–107, 2022.
- [15] R. Carrel, "The design of log-periodic dipole antennas," in *1958 IRE International Convention Record*, vol. 9, 1961, pp. 61–75.
- [16] S. Stroobandt and M. McCue, "Log-periodic dipole array calculator," 2017. [Online]. Available: <https://hamwaves.com/lpda/en/index.html>