



**HAL**  
open science

## A stochastic mobility model for traffic forecasting in urban environments

Oumaima El Joubari, Jalel Ben-Othman, Veronique Veque

► **To cite this version:**

Oumaima El Joubari, Jalel Ben-Othman, Veronique Veque. A stochastic mobility model for traffic forecasting in urban environments. *Journal of Parallel and Distributed Computing*, 2022, 165, pp.142-155. 10.1016/J.JPDC.2022.03.005 . hal-04431318

**HAL Id: hal-04431318**

**<https://hal.science/hal-04431318>**

Submitted on 22 Jul 2024

**HAL** is a multi-disciplinary open access archive for the deposit and dissemination of scientific research documents, whether they are published or not. The documents may come from teaching and research institutions in France or abroad, or from public or private research centers.

L'archive ouverte pluridisciplinaire **HAL**, est destinée au dépôt et à la diffusion de documents scientifiques de niveau recherche, publiés ou non, émanant des établissements d'enseignement et de recherche français ou étrangers, des laboratoires publics ou privés.



Distributed under a Creative Commons Attribution - NonCommercial 4.0 International License

# A Stochastic Mobility Model for Traffic Forecasting in Urban Environments

EL JOUBARI Oumaima<sup>a</sup>, BEN OTHMAN Jalel<sup>a,b</sup>, VEQUE Veronique<sup>a</sup>

<sup>a</sup> *Université Paris Saclay, CNRS, CentraleSupélec, Laboratoire des signaux et systèmes, 91190, Gif-sur-Yvette, France.*

<sup>b</sup> *Université Sorbonne Paris Nord.*

---

## Abstract

With the steadily growing traffic demand, urban traffic congestion is becoming a critical issue threatening several factors, including public safety, emissions of greenhouse gas, and transport inefficiencies. Thus, intelligent transport systems (ITS) have emerged as a promising solution to easing the burden of congestion. ITS rely on different technologies such as VANET (Vehicular Adhoc Networks) which provide the transportation system with ubiquitous connectivity allowing the exchange of traffic information between vehicles and roadside terminals. This can support numerous smart mobility applications such as traffic signal control and real-time traffic management. Hence, mobility models were developed to emulate and forecast the distribution of traffic which will be helpful to the design and management of traffic control strategies. In this context, this study specifically concentrates on developing a mobility model that reflects vehicular activities in urban environments based on vehicular information collected using vehicular communications. The behavior of vehicles along multi-lane roads and intersections is modeled as a stochastic process using queuing theory. Particularly, the queue system is analysed as a continuous-time Markov chain (CTMC) and by calculating the steady-state probabilities, different performance measures are derived and analyzed under various scenarios.

---

*Email addresses:* [oumaima.eljoubari@centralesupelec.fr](mailto:oumaima.eljoubari@centralesupelec.fr) (EL JOUBARI Oumaima),  
[jalel.benothman@centralesupelec.fr](mailto:jalel.benothman@centralesupelec.fr) ( BEN OTHMAN Jalel),  
[veronique.veque@centralesupelec.fr](mailto:veronique.veque@centralesupelec.fr) (VEQUE Veronique)

*Preprint submitted to Journal of Parallel and Distributed Computing November 23, 2021*

To validate the model, the obtained forecasts are compared with a queue model and realistic traces. The results show that the model is capable of reproducing the realistic behavior of traffic in urban roads without incurring heavy costs and time-consuming computing. The obtained estimates were then used to design an actuated traffic light and a vehicle speed adaptor. From the simulation results, it is clear that using the proposed traffic forecasting model helps reduce vehicles idling and travel times.

*Keywords:* ITS, VANET, Mobility model, Queuing theory, Markov chain

---

## 1. Introduction

With the ever-growing population around the globe, transportation demand has increased substantially, which caused an overloading of the urban road networks. When traffic is congested not only it hinders the mobility of people, but also increases collision risk, delays and exacerbates environmental pollution. All of this calls for an improvement of the conventional roadway system for the purpose of easing the pressure on the limited capacity of roads. ITS were designed to manage and optimize traffic flows by making use of the most advanced and revolutionary technologies and services. Developing this next-generation transportation systems relies mainly on the establishment of a wireless communication between all road network elements to allow timely and seamless traffic data exchange. VANET is what provides the ubiquitous connectivity in ITS by connecting moving vehicles and roadway infrastructure via an Adhoc network. To increase the scope of applications, VANET deployment can benefit from other communication technologies such as sensor networks [1, 2, 3], unmanned aerial vehicles (UAV) [4, 5, 6] and cellular networks [7, 8]. Integrating various complementary technologies will facilitate access to information and to extend the coverage area.

Now, with the emergence of vehicular communications, distributed traffic management becomes feasible. On-board and roadside units can gather updated information in real time including the current traffic condition, travel

speeds, itineraries etc, and then analyze this data to predict the future state of traffic. Mobility models can emulate traffic flows and estimate its evolution in the day ahead or in the short-term [9, 10, 11]. This can help detecting possible congestion areas and influence traffic flows onto less congested roads, synchronize traffic lights and other road signals to deal with future traffic demands, and adjust driving velocity to ensure vehicles arriving to the stop bar when the traffic light is green which helps in reducing vehicular queuing. A number of mobility models, suitable for vehicular environments, were developed for various purposes [12, 13, 14, 15]. They can be a useful design tool to evaluate the performance of proposed solutions for traffic management and communication protocols impacted by mobility before their implementation. They can also provide accurate forecasts of the future state of traffic over a road network to improve the utilization of its capacity.

The aim of this study is to propose a novel stochastic mobility model suitable for urban environments. The traffic behavior in multi-lane roads and near intersections is modelled using queuing theory features, then a Markov chain in continuous time is constructed to study the evolution of queues. This approach allows to get long-term estimates of traffic distribution using a numerical method for solving the stationary distribution. The work can be broadly separated into two parts. The first part was focused on describing traffic flow along multi-lane roads while taking into consideration lane change operations. The second part involved modeling the queuing behavior of vehicles at intersections.

A comparison of the proposed model with another queue-based method and realistic traces is conducted to investigate the accuracy of the proposed model. Results indicate that the CTMC model is able to realistically mimic urban mobility aspects. These findings are valid for both low and high traffic densities. A dynamic traffic light and a speed control policy were designed using the obtained traffic estimates. A Matlab SimEvent simulation framework was used to test and compare the performance of the proposed approach with a conventional road system. The simulation results show that using a traffic model to forecast future traffic states can help reducing the average waiting time at intersections

and travel delays while guaranteeing better road infrastructure utilization.

The remaining sections of this paper are organized as follows: Section 2 provides an overview of the literature regarding mobility models for vehicular networks. In Section 3, the mobility model is detailed and steady-state probabilities are defined. Numerical results and simulations are demonstrated in section 4. Finally, the work proposed is summarized in section 5 along with the perspectives.

## 60 2. Related work

In this section, we examine the body of prior works that support the proposed approach. There have been various models proposed to generate vehicular mobility traces. In general, these may be broadly divided into three main classes [16][17] : Trace-based, traffic-simulator-based and synthetic models.

### *2.1. Trace-based mobility models (TBMM):*

TBMM depend on traces collected from the real-world in order to derive vehicle mobility patterns. Several models suitable for both MANET and VANET scenarios have been reported in the literature [18, 19, 20]. The key strength to these models is their ability to emulate accurately the spatial and temporal  
70 measurements of mobility and are suitable for complex large-scale scenarios. However, it seems that their effectiveness depends in large part on the availability of large datasets of GPS traces, which are inaccessible to the scientific community. Several projects have been initiated to collect vehicular trajectories such as OpenStreetMap [21], CRAWDAD [22], and HighD [23]. Now, these datasets needs to be enriched with more traces to allow more accurate and  
precise results in the future.

### *2.2. Traffic simulator-based mobility models (TSBMM):*

TSBMM refer to models that are based on simulation tools to generate vehicular mobility patterns. These tools are either commercial products or free  
80 open-source softwares. PARAMICS [24, 25], CORSIM [26], AIMSUN [27] and

Table 1: Comparison of synthetic models

Model	Target environment	Map generation	Trip generation	Path computation	Lane change	Velocity	Intersection behaviour
LWR [34, 35]	Urban and freeway	Real map	Random	Kinematic waves	No	Non-uniform	Traffic signal
Henry et al. [36]	Urban	User-defined	-	Kinematic waves	No	Non-uniform	Traffic signal
Yang et al. [37]	Urban	User-defined	-	Kinematic waves	No	Non-uniform	Traffic signal
City section[38]	Urban	Grid layout	Random	RWP	No	Uniform	Random
Freeway [38]	Freeway	Undirected graph	Random	RWP	No	Non-uniform	-
Manhattan [38]	Urban	Grid layout	Random	RWP	No	Non-uniform	Probabilistic
Nagel & Schreckenberg [39]	Freeway	User-defined	Random	RWP	No	Non-uniform	-
Cellular automaton [40]	Freeway	User-defined	Random	RWP	No	Non-uniform	-
Group membership [41]	Highway	User-defined	Random	Uniform	No	Non-uniform	-
Krauß [42]	Urban and freeway	User-defined	Random	Uniform	Yes	Non-uniform	-
Bayesian [43]	Urban and freeway	User-defined	User-defined	Random	Yes	Non-uniform	-
Legendre [44]	Human mobility	Map file	Random	Brownian motion, RWalk, Group Walk	No	Normal or uniform distribution	-
Gipps [45]	Highway	Random	Random	Random	Yes	Non-uniform	-
Driving cycles [46]	Urban, rural, highway	Real map	GPS traces	Traces	No	Non-uniform	-
Gawon [47]	Urban and highway	User-defined	Random	-	No	Uniform	Traffic signal
Mirchandani et al. [48]	Urban intersections	User-defiend	-	-	No	-	Traffic signal
Cremer & Landefeld [49]	Urban	User-defined	Random	RWP	No	Uniform	Traffic signal
Mohimani et al. [50]	Urban	Grid layout	Random	Random	No	Non-uniform	Deterministic
LINTAS [51]	Urban and Highway	Real map	Random	Random	No	Non-uniform	-

PTV Vissim [28, 29] are one of the first simulation tools designed for vehicular scenarios. The purchase of a licence is required to use these commercial tools. There exists several free simulation programs such as SUMO [30, 31] and VanetMobiSim [32, 33] which can be used for traffic management and VANET simulation. These above-mentioned models allow a detailed simulation of mobility. However, creating the complex configuration and the very long simulation time of large scale scenarios represent a major drawback of simulator-based models.

### 2.3. Synthetic models:

90 Synthetic models present movements of mobile nodes based on mathematical approaches, and can be divided into five sub-classes: Traffic stream models, stochastic models, car-following models, behavioural models, queue models and machine learning (ML)-based models. Table 1 summarizes the mobility aspects and use cases considered by the synthetic models reviewed hereinafter.

### 2.3.1. Traffic stream models

These models study traffic as an hydrodynamic phenomenon with regard to three fundamental parameters characterizing traffic which are speed, density and flow. The most prominent work in this category is the works of Lighthill-Whitham-Richards (LWR) [34, 35]. The model describes the traffic flow dynamics along roads and junctions based on kinematic waves. Similar approaches have been presented in [36] and [37]. Traffic stream models can only be exploited to mimic basic mobility aspects as they do not provide an exhaustive level of detail. Besides their lack of preciseness, finding a solution for these models when traffic flow varies continuously over time is a cumbersome task.

### 2.3.2. Stochastic models

Stochastic models describe the mobility of vehicles traveling over a graph or a map as a random process. There have been various stochastic models reported in the literature such as City section [16], Freeway and Manhattan [38]. These models are suitable for urban environments. Nagel and Schreckenberg [39] addressed mobility in single lane-freeways. The model was later extended in [40] to incorporate drivers' reaction to the speed and distance headway to the preceding vehicle. The true benefit of these models is their easy and rapid implementation, but they require further improvement to accurately mimic the real-world behavior of vehicles in both urban and freeway environments. Most notably, the lane change behavior, the stop-and-go phenomenon, and vehicles queuing at intersections need to be considered.

### 2.3.3. Car following models

In this kind of models, the behavior of each individual vehicle is modelled while taking into account measures such as the distance from the vehicle ahead and its speed. The work in [41] presented a car-following model suitable for single-lane roads. Other approaches were introduced to consider lane-change operation in multiple-lane roads such as [42] and [43]. Compared to the The aforementioned types of models, the car-following models are more accurate and

realistic. But due to the abundance of detail, their deployment can be extremely challenging and may incur complex computation particularly to model large scale networks. Moreover, these models focus specifically on the behaviour of an individual vehicle and they fail to capture the behaviour of the road system as a whole

#### 2.3.4. Behavioural models

130 The premise of these models is based on behavioral rules guided by social impact, rational decision-making or stimulus-reaction actions. The first behavioural model was introduced by Legendre *et al.* [44] to emulate human mobility. Later on, several works adapted the model to fit vehicular mobility. The model proposed by Gipps in [45] reproduce the response behaviour to the sudden braking of the preceding vehicle. Authors in [46] developed an improved behavioural model able to capture various behavioural characteristics that cannot be derived from driving cycles traces. The downside of these models is that they require complex calculations which makes it tedious to simulate large-scale traffic scenarios.

#### 140 2.3.5. Queue models

Queue-based models apply queuing theory and basic probabilistic distributions to deal with vehicles standing in queues. Gawron [47] was the first to propose a queue model suitable for vehicular traffic. The method introduced in [48] used queuing theory to optimize traffic at isolated signal-controlled intersections, while authors in [49] studied traffic at both intersections and different parts of the street. In [50] a model to describe the movement of vehicles at both intersections and different parts of the street was proposed. Authors in [51] proposed a traffic simulator built in Simulink that simulates traffic in a multi-lane road as a M/M/n in an attempt to mitigate traffic jams. The models  
150 mentioned above afford the advantage of a simple and rapid modeling and deployment of traffic flow patterns. They also jointly reproduce microscopic and macroscopic mobility properties to provide a sufficient level of detail. However,



they disregard several mobility aspects such as the coordination among vehicles crossing an intersection and lane changing operation.

#### 2.4. *ML-based models*

ML-based approaches have received considerable attention from researchers as an alternative for vehicular traffic prediction. These models generate a traffic prediction function through learning from realistic examples. The learning process is based on optimisation algorithms that aim at reducing the gap between  
160 the estimated and expected values for a more accurate prediction. Authors in [52] proposed a deep learning-based forecasting model that relies on 40 day traffic data collected by 58 cameras located at different locations around London. The primary advantage of the proposed model is its ability to reduce forecasting errors. However, only two features could be captured which are time and traffic density. Another drawback is the extra costs associated with the deployment of cameras all over the road network. In [53] a K-nearest neighbor based classification model is used for traffic flow prediction using Correlation analysis. This model aims at reducing storage and computation costs of large training samples by considering off-line distributed training and online parallel predic-  
170 tion. A multitask learning-based artificial neural network was proposed in [54] to predict traffic flows. The data used in the model is the vehicle flow rates of discrete time series which were recorded every 15 min. The model proves its efficiency to provide estimates closer to the true values.

ML-based models are able to provide fast and low error rate predictions. However, they require tremendous offline training which limit their usage in the real world. Traffic flow patterns have different features depending on the locations, speed, time, etc. Therefore, it is important to train the predictor multiple times to reflect different scenarios. Accordingly, the running time of the learning process needs to be reduced to effectively apply ML-based traffic  
180 prediction approaches in the real world. Another drawback of these models is their reliance on real-life examples in the training process. The datasets used by ML-based models need to be large enough to obtain a well-trained model.

In less traveled or sparse areas where historical traces are less readily available, ML-based models are enable to ensure low prediction error rates.

The approach proposed in this study differs from the works outlined above as we aim to develop a novel stochastic model that can be applied to generate mobility patterns in multiple-lane urban roads using queuing theory. The model not only emulate the behavior of vehicles driving on roads but also describes the behavior of queues formed at intersections. Moreover, the most crucial mobility  
190 aspects such as the spatial configuration, lane change, velocity, and routing were taken into consideration. Changes in the system are modeled as a continuous-time Markov chain which allow to reflect the stochastic and variable nature of the transportation network and to predict future traffic states. The strong point of Markov chains is the memoryless property where the future event occurring is not affected by the occurrence of past events. As a consequence thereof, the model is always suitably efficient even if historical data are not available. Contrarily to machine-learning based prediction models that highly rely on historical data in the training process. To compute the stationary probabilities of the Markov chain, an iterative and direct numerical method was used. Different  
200 performance indicators were defined and used to analyse the system for different traffic scenarios such as queue lengths, travel times and delays that are crucial to design traffic planning and management applications in the context of smart mobility. The chief strength of the proposed model is its low complexity since it relies on a set of simplistic assumptions without incurring a loss of realism and accuracy in the results. Through results demonstrated in section 4, the model shows its effectiveness to emulate urban traffic and can be successfully used in the context of ITS.

### 3. Proposed Model

Having reviewed related work, we present in this section the main body of  
210 our contribution. The main goal of this study is to design a mobility model that allows describing traffic dynamics in an urban environment and predicting

the future traffic condition along arterial roads and at controlled and uncontrolled intersections. In this study, we extend a previous model proposed in [55] where a stochastic model was introduced to emulate the standing queues at intersection in urban environments. Our novel model not only describes traffic at intersections but also on multi-lane roads while incorporating extra details such as road configuration, lane change and velocity.

Our approach can be seen as a two-stage process. First, a queue system is built to describe the traffic dynamics in an urban area. Therein after, Markov chains in continuous time are built to study the evolution of the queues. Principles of queuing theory have been widely used in traffic engineering [56, 57], because it allows to study waiting lines and queues, and to cover problems of optimization involving waiting and delays in servicing vehicles. So the use of this approach is not only inexpensive in terms of deployment but also allows to predict queue lengths and waiting times.

Vehicular mobility is characterized by having a predictable nature as vehicles' mobility is constrained by several factors such as traffic regulations and road layouts. However, the uncertain drivers' driving behaviour adds a more stochastic side to vehicular traffic. The arrivals of vehicles, acceleration, deceleration and route choice are processes marked by uncertainty. Therefore, deterministic or probabilistic approaches are not suitable for modeling traffic as they are independent of time. Stochastic approaches such as Markov chains are more adequate to reproduce the random and time-dependant properties of vehicular traffic.

To model urban traffic, a city section that contains a set  $\mathcal{N}$  of  $N$  road intersections linked by double-way and multi-lane roads is considered.  $\mathcal{R}$  denotes the set of single-way roads composing the network. Three types of intersections are modelled: roundabouts, stop-and-go and signal-controlled intersections. It is supposed that vehicles arrive to an intersection from roads outside the network or from adjacent intersections within the studied area. Vehicles arriving to the intersection are either served immediately or queued until the intersection is available. Once a vehicle is served, it is then routed to its next intersection, or

leaves the network.

In this study, it is assumed that each vehicle is equipped with a communication unit, and exchanges traffic information with roadside units deployed along the road and at intersections. RSUs use V2I communications to exchange packets with vehicles within their coverage area. However, it is quite likely that some nodes in the network will be isolated due to the limited communication range of RSUs. Moreover, placing RSUs at regular intervals could not be guaranteed for their cost of deployment. To improve the efficiency of V2I infrastructure, V2V  
250 communications can be used to extend the connectivity of RSUs and to ensure service continuity in the VANET. Several cooperation schemes were developed to combine both V2I and V2V to mitigate the service disruption problem in uncovered areas [58, 59, 60].

The RSUs are able to collect information about arrival and departure times, travel speeds and next destination intersection. Then, the RSUs periodically computes average quantities such as arrival rates, average speeds and density and then broadcast the information to vehicles. These information are used by vehicles to forecast future traffic states using the approach presented here.  
260 Figure 1 depicts an example of the street layout considered in this study.

The road network can be thereby modelled using queuing theory as depicted in figure 2. Table 2 summarizes all the notations used herein after.

Each lane of a road is modelled as a fixed-capacity queue and multiple servers each holding a vehicle for a specific service time representing the time needed to travel from the start intersection to the end intersection. The probability distribution used to model the arrival and departure of vehicles is similar to works in [61, 62, 63]. The vehicles arrive from the outside network to an intersection within the studied city section following a Poisson process. The Poisson distribution is most suitable as vehicles arrive independently and in a random  
270 manner within a given time interval. Vehicles originating from adjacent intersections arrive to the intersection with a rate calculated as a function of the average service time of all roads meeting at the considered intersection. The vehicles are stored in the queue and released following FIFO service discipline.

Notation	Description
$N$	Number of intersections
$\lambda_i, \mu_i$	Arrival and departure rates at intersection $i$
$\lambda_i^{out}$	Arrival rate at intersection $i$ from the external network
$R$	Routing probability matrix
$r_{ij}$	Routing probability from intersection $i$ to $j$
$C_i$	Queue capacity of intersection $i$
$S_i$	Average sojourn time of intersection $i$
$W_i$	Average waiting time of intersection $i$
$Q_i$	Average queue length of intersection $i$
$\lambda_r, \mu_r$	Arrival and service rates of a road $r$
$Len$	Length of a road
$M$	Number of lanes of a road
$C_{lane}$	Capacity of lanes
$\lambda_m, \mu_m$	Arrival and service rates at lane $m$
$D_m$	Density of lane $m$
$\alpha_m$	Probability to travel on lane $m$
$V_m^{avg}$	Average speed of lane $m$
$L_m$	Average number of vehicles traveling on lane $m$
$VC_m$	Volume-to-capacity ratio of lane $m$
$S_m$	Average sojourn time of lane $m$
$LC_{nm}$	Lane change probability from lane $n$ to lane $m$
$X(t)$	Vector representing traffic over a road at time $t$
$X_m(t)$	Random variable representing traffic over a lane $m$ at time $t$
$Y(t)$	Vector representing traffic at intersections at time $t$
$Y_i(t)$	Random variable representing traffic at intersection $i$ at time $t$
$\Omega, \Theta$	State spaces
$P, T$	Transition probability matrices
$\pi, \Psi$	Steady-state probability distributions

Table 2: Notations

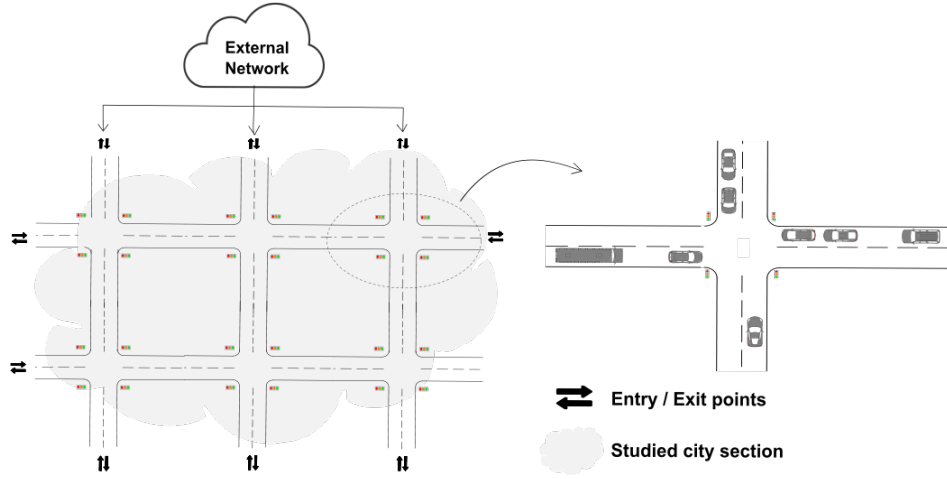

Figure 1: A diagram of a road layout in an urban area

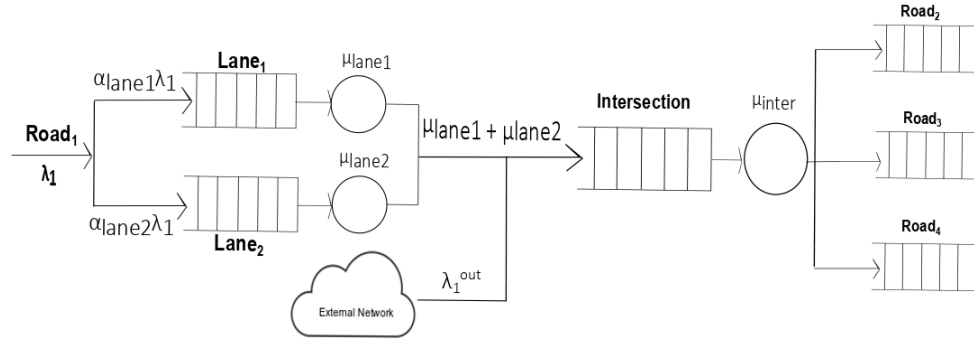

Figure 2: Traffic scenario represented as a queue system

Vehicles can undergo the service process simultaneously as vehicles can travel along a road section at the same time. Each vehicle is then held by a single server for a certain time and then released. We also assume the amount of time between two successive service completions is random and independent from one another. Hence, the service time is modelled following an exponential distribution. After being serviced, the vehicle can travel to its next destination or leaves the network.

The arrival rate and service rate of a road  $r$  are denoted  $\lambda_r$  and  $\mu_r$  respectively. The arrival rate  $\lambda_r$  of a road  $r$  linking intersection  $i$  to intersection  $j$  is

defined as follows:

$$\lambda_r = \mu_i \cdot p_{ij}, \forall r \in \mathcal{R} \quad (1)$$

$\mu_i$  is the service rate of the start intersection  $i$  and  $p_{ij}$  the probability that a vehicle travels from intersection  $i$  to intersection  $j$ .  $\mu_i$  is the service rate of the start intersection  $i$  that is extracted from historical traces collected by RSUs and  $p_{ij}$  the probability that a vehicle travels from intersection  $i$  to intersection  $j$ .

We denote by  $\alpha_m$  the probability that a vehicle chooses to travel on lane  $m$ , with  $\sum_{m \in \mathcal{M}} \alpha_m = 1$ . The arrival rate of a lane  $m$  can therefore be calculated as follows:

$$\lambda_m = \alpha_m \cdot \lambda_r \quad (2)$$

The service rate of a lane  $m$  is calculated as a function of its length  $Len$  and its average speed  $V_m^{avg}$ :

$$\mu_m = \frac{V_m^{avg}}{Len} \quad (3)$$

The service rate of the road  $r$  is defined as the sum service rate over its lanes as follows:

$$\mu_r = \sum_{m \in \mathcal{M}} \mu_m \quad (4)$$

As stated before, the arrivals from the outside network to one of the studied intersections are random and independent and are therefore modelled using a Poisson distribution of rate  $\lambda_i^{out}$ . The arrivals from neighboring intersection depends on the service rate of roads leading to the intersection. Let  $I_i$  be the set of incident roads to intersection  $i$ . The arrival rate of an intersection  $i$  is then calculated by the following formula:

$$\lambda_i = \lambda_i^{out} + \sum_{r \in I_i} \mu_r, \forall i \in \mathcal{N} \quad (5)$$

For simplicity, we model the service time using an exponential distribution with rate  $\mu_i$ . The service rate can be extracted from historical traces collected

300 by RSUs and it represents the number of vehicles crossing the intersection in a period of time. For signal-controlled intersections, the service rate represents the average number of vehicles crossing the intersection during a traffic signal cycle.

To ensure that the queuing system can evolve to a steady state, we assume that the arrival rates  $\lambda$  and service rates  $\mu$  satisfy the following constraint:  $\lambda < \mu$ . It needs to be emphasized that this condition must be satisfied by the lanes, roads and intersections. Hence, we consider scenarios where :

$$\lambda_m < \mu_m, \forall m \in \mathcal{M} \quad (6)$$

The satisfaction of the constraint 6 implies the following:

$$\lambda_r < \mu_r, \forall r \in \mathcal{R} \quad (7)$$

Similarly, it is assumed that the arrival rate of intersections must be less than their service rate:

$$\lambda_i < \mu_i, \forall i \in \mathcal{N} \quad (8)$$

### 3.1. Markov chain for road traffic

In order to build the proposed model, we construct as a first step a Markov  
 310 Chain in continuous time to model the behavior of queues representing a multi-lane road. An urban road of  $M$  lanes is considered, where  $C_{lane}$  is its lanes capacity, which represents the number of vehicles that can be handled by a single lane.

Let  $X(t) = (X_1(t), \dots, X_M(t))$  be a vector of random variables representing the traffic state of a road, where each element  $X_m(t)$  represents the number of vehicles travelling on lane  $m$ , such as, for each  $m \in \mathcal{M}$  and  $t \in [0, +\infty)$ ,  $0 \leq X_m(t) \leq C_{lane}$ . Therefore, the open network allows to study a population set  $\mathcal{Q}$  of size  $0 \leq |\mathcal{Q}| \leq M \times C_{lane}$ . The collection of possible values of  $X(t)$  is called a state space. Let  $\Omega$  be the state space of the random variable  $X(t)$ .  
 320 Given a state  $x \in \Omega$ , the value of each element  $X_m(t)$  of the random vector is denoted  $x_m$ .



The Markov chain modeling a road section is defined as the random process  $\{X(t), t \geq 0\}$ , defined by a finite state space  $\Omega$ , and a state transition matrix  $P$ , where its element  $p_{xy}$  reflects the likelihood of the system transitioning from state  $x$  to state  $y$ . Given  $P$  the transition rate matrix and  $\pi$  the equilibrium distribution, the balance equations can be expressed mathematically as:

$$\pi_x \cdot p_{xy} = \pi_y \cdot p_{yx} \quad (9)$$

Then the global balance equations are obtained by summing over  $y$ :

$$\pi_x \cdot \sum_{y \in \Omega \setminus \{x\}} p_{xy} = \sum_{y \in \Omega \setminus \{x\}} \pi_y \cdot p_{yx} \quad (10)$$

Thus, to establish the transition probability matrix  $P$ , we first denote the lane change probability from lane  $n$  to lane  $m$  by  $LC_{nm}$ . If a vehicle is traveling on a lane  $n$ , the probability that it changes to an adjacent lane  $m$  is defined as a function of density. If  $m$  is more congested, there is a low probability the vehicle will change to lane  $m$ . However, if the current lane  $n$  is more dense than the destination lane  $m$ , the lane change probability is increased. Given  $D_n$  and  $D_m$  the density of lane  $n$  and lane  $m$  respectively, the lane change probability can be expressed by the following:

$$LC_{nm} = \begin{cases} 1 - \frac{D_m}{D_n + D_m} & \text{if } n \text{ and } m \\ & \text{are adjacent lanes;} \\ 0 & \text{otherwise.} \end{cases} \quad (11)$$

Another characteristic of matrix  $P$  is that the row sum is 0, such as for each  $(x, y) \in \Omega^2$ :

$$p_{xy} = \begin{cases} Pr\{X(t+1) = y | X(t) = x\} \geq 0, & \text{if } x \neq y; \\ - \sum_{z \in \Omega \setminus \{x\}} p_{xz} & \text{if } x = y. \end{cases} \quad (12)$$

Where the non-diagonal element are equal to the transition rate from state  $x$  to  $y$ , and the diagonal elements are calculated by the sum of other rates of

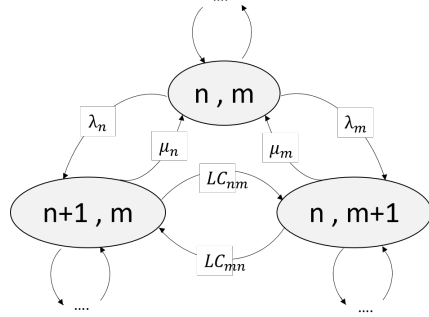

Figure 3: Transition graph of the Markov chain describing traffic in a double-lane road.

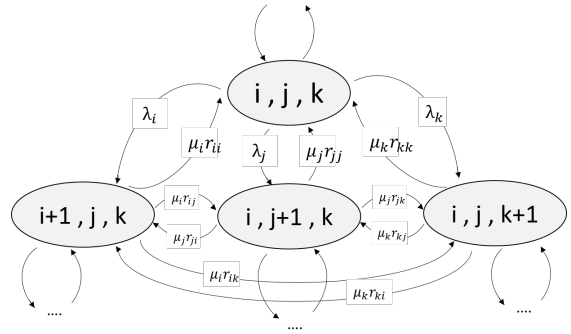

Figure 4: Transition graph of the Markov chain describing traffic in three intersections.

330 the same row. The transition matrix  $P$  is formed by the collection of transition probabilities  $p_{xy}$  that describes the probability that a system will evolve from state  $x$  to state  $y$ . Figure 3 represents the corresponding Markov graph.

$$p_{xy} = \begin{cases} \lambda_m, & \text{if a vehicle arrives at lane } m; \\ \mu_m, & \text{if a vehicle leaves lane } m; \\ LC_{nm}, & \text{if a vehicle changes from lane } n \text{ to lane } m; \\ - \sum_{z \in \Omega \setminus \{x\}} p_{xz} & \text{if } x = y; \\ 0 & \text{otherwise.} \end{cases} \quad (13)$$

Given the transition probability matrix  $P$  defined previously and the equilibrium vector  $\pi$ , the balance equation is expressed as follows:

$$\begin{aligned} \pi_x \cdot \sum_{y \in \Omega \setminus \{x\}} \left( \sum_{m \in \mathcal{M}} \lambda_m \cdot \mathbb{1}_{(p_{xy}=\lambda_m)} + \sum_{m \in \mathcal{M}} \mu_m \cdot \mathbb{1}_{(p_{xy}=\mu_m)} + \sum_{n \in \mathcal{M}} \sum_{m \in \mathcal{M} \setminus \{n\}} LC_{nm} \cdot \mathbb{1}_{(p_{xy}=LC_{nm})} \right) = \\ \sum_{y \in \Omega \setminus \{x\}} \pi_y \left( \sum_{l \in \mathcal{M}} \lambda_l \cdot \mathbb{1}_{(p_{yx}=\lambda_l)} + \sum_{m \in \mathcal{M}} \mu_m \cdot \mathbb{1}_{(p_{yx}=\mu_m)} + \sum_{n \in \mathcal{M}} \sum_{m \in \mathcal{M} \setminus \{n\}} LC_{nm} \cdot \mathbb{1}_{(p_{yx}=LC_{nm})} \right) \end{aligned}$$

### 3.2. Markov chain for intersection traffic

The next step is to construct a CTMC to model traffic at intersections. We consider that the road network contains a set  $\mathcal{N}$  of road intersection. It is assumed that  $\mathcal{N}$  is composed of  $N$  intersections ( $\mathcal{N} = \{1..N\}$ ). Each intersection  $i \in \mathcal{N}$  is assigned a corresponding value  $C_i$  in  $\mathcal{C} = \{C_1, C_2, \dots, C_N\}$  which  
340 represents the sum of capacities of roads that meet at the intersection.

The Markov chain is defined as the random process  $\{Y(t), t \geq 0\}$  where  $Y(t) = (Y_1(t), \dots, Y_N(t))$  is a vector of multiple random variables. Each element  $Y_i(t)$  represents the number of vehicles queuing or crossing an intersection  $i$ . As waiting lines at intersection are of a limited capacity that is relative to the lengths of roads leading to the intersection, we assume that the random variable verify the following constraint:  $\forall i \in \mathcal{N}$  and  $\forall t \in [0, +\infty[, 0 \leq Y_i(t) \leq C_i$ . A population set  $\mathcal{A}$  of size  $0 < |\mathcal{A}| < \sum_{i \in \mathcal{N}} C_i$  can be studied by the Markov chain.

The state space  $\Theta$  is defined as the collection of possible values of  $Y_i(t)$ , and  $T$  the transition matrix such as, given  $(u, v) \in \Theta^2$ ,  $T_{uv}$  is the transition  
350 probability from state  $u$  to state  $v$ . We first define the routing matrix  $R = (r_{i,j})_{1 \leq i \leq N, 1 \leq j \leq N}$  where each element  $r_{ij}, \forall (i, j) \in \mathcal{N}^2$  is the probability that a vehicle travels from intersection  $i$  to intersection  $j$ . The diagonal elements  $r_{ii}, \forall i \in \mathcal{N}$  is the probability that a vehicle leaves the network from intersection  $i$ . The routing probability matrix is supposed to be computed periodically by RSU using collected data.

The transition matrix  $T$  can then be established as follows:

$$T_{uv} = \begin{cases} \lambda_i, & \text{if a vehicle joins the network from intersection } i; \\ \mu_i \cdot r_{ii}, & \text{if a vehicle leaves the network from intersection } i; \\ \mu_i \cdot r_{ij}, & \text{if a vehicle travels from intersection } i \text{ to intersection } j; \\ - \sum_{w \in \Theta \setminus \{u\}} T_{uw} & \text{if } u = v; \\ 0 & \text{otherwise.} \end{cases} \quad (14)$$

The transition diagram of the proposed Markov chain is depicted in figure

4. The stationary distribution  $\Psi$  of the Markov Chain  $T(t)$ , is expressed by:

$$\begin{aligned} \Psi_u \cdot \sum_{v \in \Theta \setminus \{u\}} & \left( \sum_{i \in \mathcal{N}} \lambda_i \cdot \mathbb{1}_{(T_{uv}=\lambda_i)} + \sum_{i \in \mathcal{N}} \mu_i \cdot r_{ii} \cdot \mathbb{1}_{(T_{uv}=\mu_i \cdot r_{ii})} + \sum_{i \in \mathcal{N}} \sum_{j \in \mathcal{N} \setminus \{i\}} \mu_i \cdot r_{ij} \cdot \mathbb{1}_{(T_{uv}=\mu_i \cdot r_{ij})} \right) = \\ \sum_{v \in \Theta \setminus \{u\}} & \Psi_v \left( \sum_{i \in \mathcal{N}} \lambda_i \cdot \mathbb{1}_{(T_{vu}=\lambda_i)} + \sum_{i \in \mathcal{N}} \mu_i r_{ii} \cdot \mathbb{1}_{(T_{vu}=\mu_i \cdot r_{ii})} + \sum_{i \in \mathcal{N}} \sum_{j \in \mathcal{N} \setminus \{i\}} \mu_i \cdot r_{ij} \cdot \mathbb{1}_{(t_{vu}=\mu_i \cdot r_{ij})} \right) \end{aligned}$$

### 3.3. Numerical resolution and performance measures

The Grassmann-Taksar-Heyman (GTH) algorithm [64] is used to compute values of the stationary distributions. Then, the performance measures are obtained by applying Little's law.

First, we derive three different metrics to study the performance of roads which are the average number of vehicles, the congestion rate and the average travel time.

Let  $L_m$  denote the average number of vehicles traveling on lane  $m$ :

$$L_m = \sum_{x \in \Omega} \pi_x \cdot x_m, \forall m \in \mathcal{M} \quad (15)$$

The estimated volume-to-capacity ratio  $VC$  which represents the congestion rate is deduced:

$$VC_m = L_m / C_{lane}, \forall m \in \mathcal{M} \quad (16)$$

By applying Little law formula, the average sojourn time  $S_m$  of lane  $m$  can be expressed:

$$S_m = \frac{1}{\lambda_m} \cdot \sum_{x \in \Omega} \pi_x \cdot x_m, \forall m \in \mathcal{M} \quad (17)$$

For intersections, we use the average queue lengths and average waiting time as performance metrics to evaluate the system. The average waiting time of an intersection  $i$  is denoted  $W_i$  and defines the average time a vehicle spends queuing at the intersection.  $W_i$  is calculated as the difference between the sojourn time  $S_i$  and the service time  $\frac{1}{\mu_i}$ :

$$W_i = S_i - \frac{1}{\mu_i}, \forall i \in \mathcal{N} \quad (18)$$

The average sojourn time of an intersection  $S_i$  can be calculated using Little's law as below:

$$S_i = \frac{1}{\lambda_i} \cdot \sum_{u \in \Theta} \Psi_u \cdot u_i, \forall i \in \mathcal{N} \quad (19)$$

From equations 18 and 19,  $W_i$  can be deduced:

$$W_i = \frac{1}{\lambda_i} \cdot \sum_{u \in \Theta} \Psi_u \cdot u_i - \frac{1}{\mu_i}, \forall i \in \mathcal{N} \quad (20)$$

And finally, the average length of a queue  $Q_i$  at an intersection  $i$  can be computed as below:

$$Q_i = \lambda_i \cdot W_i, \forall i \in \mathcal{N} \quad (21)$$

By replacing  $W_i$  by its value, we obtain the following formula:

$$Q_i = \sum_{u \in \Theta} \Psi_u \cdot u_i - \frac{\lambda_i}{\mu_i} \quad (22)$$

#### 4. Numerical results and Simulation

This section reports the results of the analysis we have computed. The numerical results of the different performance measures are first presented. Then, we compared the proposed model with realistic traces and Gawron's queue model [47]. Finally, the obtained estimates are used in two different smart mobility applications and a comparison between the performance of a conventional and intelligent road systems is conducted using the SimEvents simulation framework proposed in [65].

To study the performance of the CTMC urban traffic model, a realistic road map is considered. A city section composed of three intersections of different policies are linked by bidirectional multi-lane roads. In tables 3 and 4, the spatial configuration of the city section is given. Parameters used in this study are extracted from inD [66] and roundD [67] datasets that offer naturalistic

Table 3: Road configuration

	Road configuration			
Road id	Road length	Start intersection	End intersection	Number of lanes
Road 1	300 m	1	2	2
Road 2	300 m	2	1	2
Road 3	500 m	1	3	3
Road 4	500 m	3	1	3
Road 5	300 m	2	3	2
Road 6	300 m	3	2	2

Table 4: Intersection configuration

	Intersection configuration	
Intersection id	Policy	Queue capacity
Intersection 1	Traffic light	30
Intersection 2	Stop-and-go	45
Intersection 3	Roundabout	30
Routing matrix	$\begin{pmatrix} 0.3 & 0.2 & 0.5 \\ 0.2 & 0.2 & 0.6 \\ 0.4 & 0.3 & 0.3 \end{pmatrix}$	

390 vehicle trajectories recorded at German intersections and multi-lane roads using a drone with a frame rate equal to 25Hz.

In a first set up, the performance of the city section is studied under different density scenarios to investigate to which extent the proposed model is able to reflect the impact of density on the performance of the road system. Values of the intersection service rate, lane average speed, and lane arrival probability  $\alpha$  are extracted from traces recorded over 15 minutes. Table 5 summarizes the values of the parameters considered in this set-up.

First, we evaluate and compare results of the average number of vehicles and average travel time for the different roads. Figure 5 refers to the average

Table 5: Set-up configuration

	Road parameters		
Road id	Lane id	Average speed (m/s)	Arrival probability
Road 1	Lane 1	25,607	0,535
	Lane 2	33,291	0,465
Road 2	Lane 1	27,673	0,407
	Lane 2	40,407	0,593
Road 3	Lane 1	23,643	0,74
	Lane 2	28,522	0,452
	Lane 3	29,731	0,808
Road 4	Lane 1	24,875	0,472
	Lane 2	30,877	0,707
	Lane 3	32,841	0,821
Road 5	Lane 1	24,208	0,603
	Lane 2	30,992	0,397
Road 6	Lane 1	27,482	0,319
	Lane 2	32,134	0,681
	Intersection parameters		
Intersection id	Intersection 1	Intersection 2	Intersection 3
Service rate (vehicle/minute)	14,25	17	14

400 number of vehicles traveling on the different roads as an arrival rate function. The curves show clearly that as arrivals increase, all roads show an increase in traffic volume. For low values of the arrival rate, the number of vehicles is slow-growing, because a large number of vehicles depart from the road within the time unit. However, when the density tends toward the road capacity, the travel time gets slowed down and consequently the number of vehicles serviced within a tile unit decreases. It's also worth noting that higher traffic is noticed on longer roads with more lanes as they are able to handle more vehicles. Moreover, roads of the same length can have different performances. This may be explained by

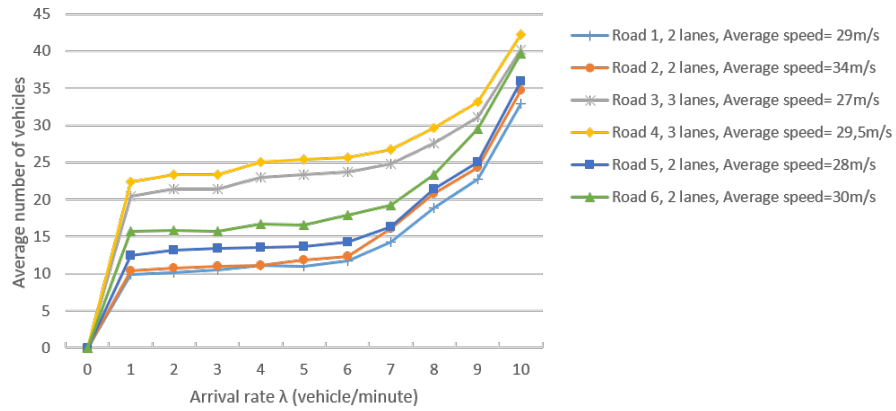

Figure 5: Per road average number of vehicle against arrival rate

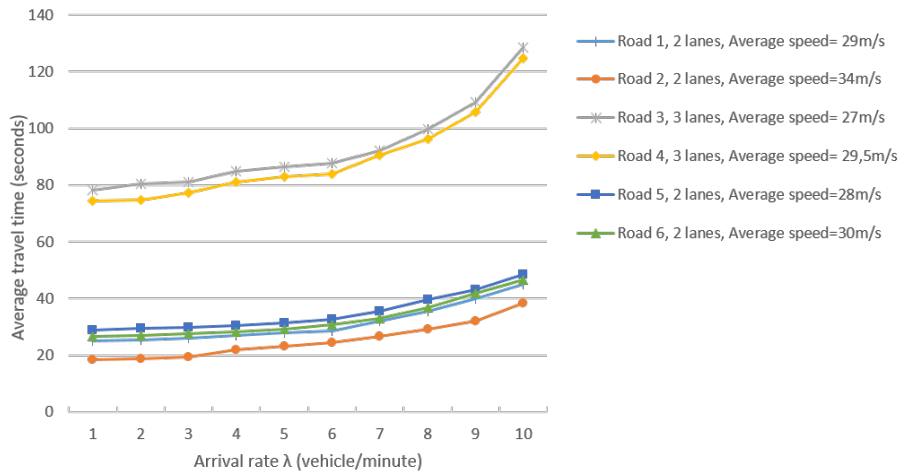

Figure 6: Per road average travel time against arrival rate

the disproportionate traffic volume that can be drawn into opposite directions  
 410 of the road, the average speed on each road and the waiting time at the end  
 intersection. Figure 6 shows the relationship between arrival rates and the  
 average travel time. It can be seen that the roads that encounter the lowest  
 traffic volume and higher average speed are also the ones to ensure rapid traffic  
 of vehicles. It is also apparent that a lot of time is required for vehicles to cross  
 long distance roads than short distance roads.



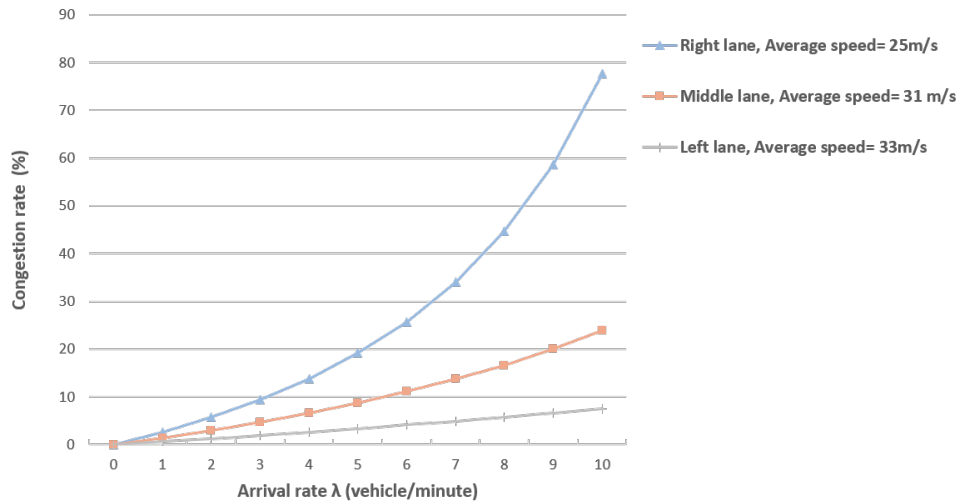

Figure 7: Per lane average travel time against arrival rate

Figure 7 shows the graphs of the congestion rate in the right lane, middle lane and left lane respectively of a road 4. As expected, there is significantly a higher congestion rate on the right lane than the left ones. This is due to more traffic being drawn onto the right lane. Moreover, vehicles traveling with low velocities tend to use the right lane, while when traveling at high-speeds drivers shift to left lanes for smoother flow of traffic.

The performance of the three intersections is also analyzed. The metrics selected to evaluate the intersection performance are the average waiting time and average queue lengths. The estimates of both performance metrics are calculated using data extracted from traces. The results are calculated for a time period of 10 minutes to investigate the evolution of queues over time.

The predicted average queue lengths are given in figure 8. It can be noted that longer queues are formed on the stopover of a signal controlled intersection, as vehicles have to queue for a considerable amount of time at a red traffic light before crossing. Figure 9 shows that the results for the average waiting time is different from one policy to another. The long queues at a traffic light controlled intersection gives rise to delays. Contrary, the roundabout intersection has a

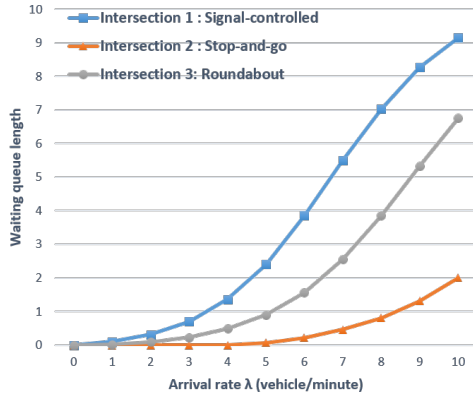

Figure 8: Per intersection average queue lengths over time

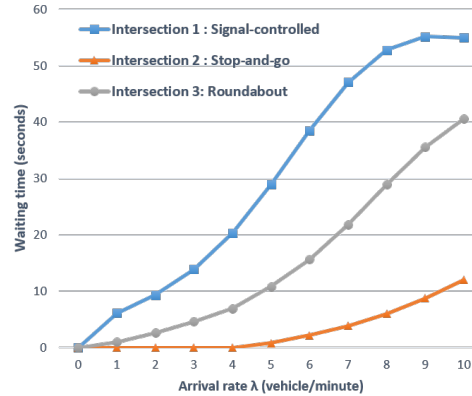

Figure 9: Per intersection average waiting time over time

lower waiting time because vehicles are only required to yield when there is traffic. In stop-sign intersections, the waiting time is very low due to the frequent stop-and-go driving.

In order to test the predictive ability of the proposed model, results for the number of vehicles and queue lengths at intersections are compared with realistic traces and the results of Gawron’s queue model [47]. The percent accuracy of both the CTMC model and Gawron queue model is calculated and plotted.

440 Accuracy is computed using the following formula:

$$Accuracy = \left(1 - \frac{|Real\ value - Estimated\ value|}{Real\ value}\right) \times 100$$

The average number of vehicles is compared with the estimated values as illustrated in figure 10. While in figure 11, the actual values of the average queue lengths are compared with the obtained results using the CTMC model and Gawron’s queue model. The results of the proposed model follow the same trend as the realistic traces. However, the obtained results using the Gawron model are random and don’t follow the same evolution as the curve representing the traces.

A first look at the chart shows that the CTMC outperforms the Gawron

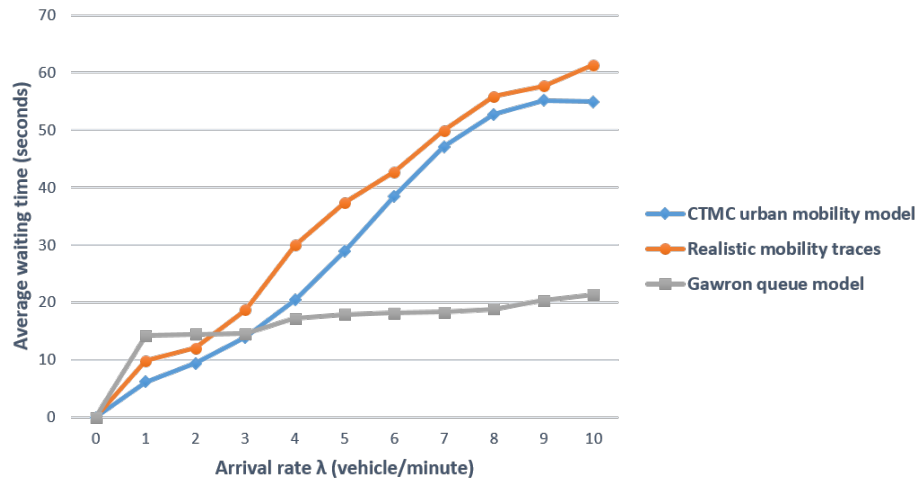

Figure 10: Average number of vehicles over time

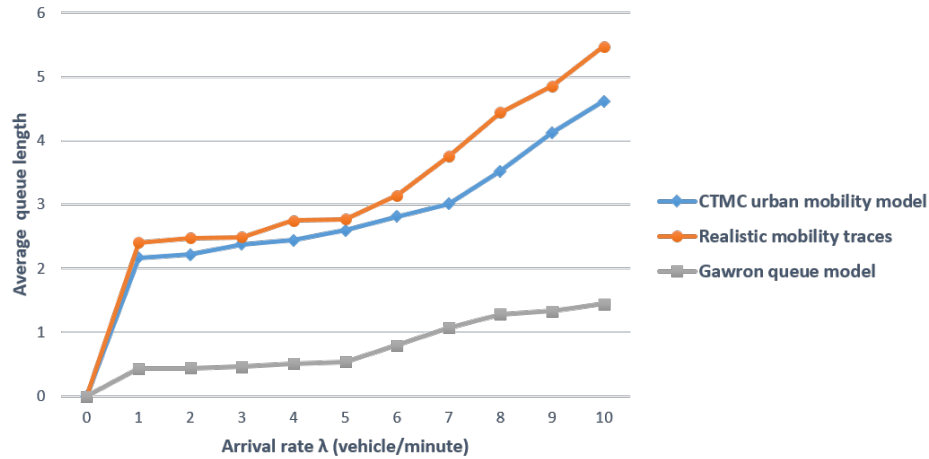

Figure 11: Average queue lengths over time

model in terms of forecasting accuracy. For this case study, the proposed model  
 450 allows to obtain an average of 93% accuracy for the expected number of vehicles,  
 against 31% accuracy obtained with Gawron model. For the expected queue  
 lengths, the average accuracy of the CTMC model is 80% and 24% for the  
 Gawron model. One can notice the wide disparity between the accuracy of the  
 CTMC-based model proposed in this study and the queue-based model proposed

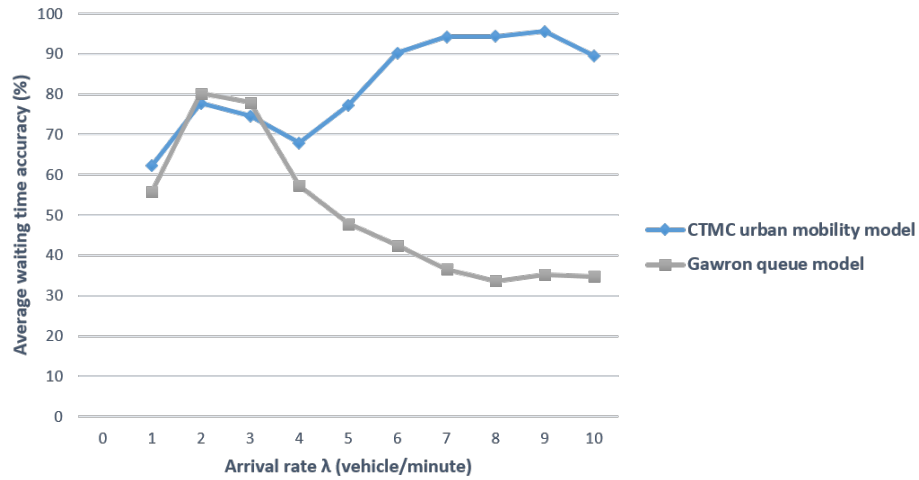

Figure 12: Percent accuracy of the average number of vehicles over time

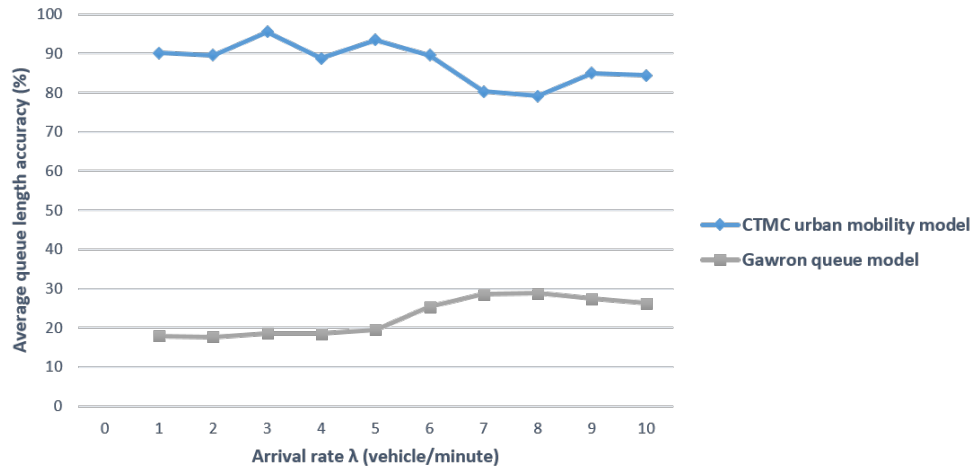

Figure 13: percent accuracy of the average queue lengths over time

in [47].

Finally, to underline the importance of using the traffic prediction models to improve the transport system efficiency using smart mobility applications, an actuated traffic light and an automatic speed control strategies were designed and simulated using the MATLAB's SimEvent tool. The signal-controlled intersection is constructed as represented in figure 14. The traffic signal block

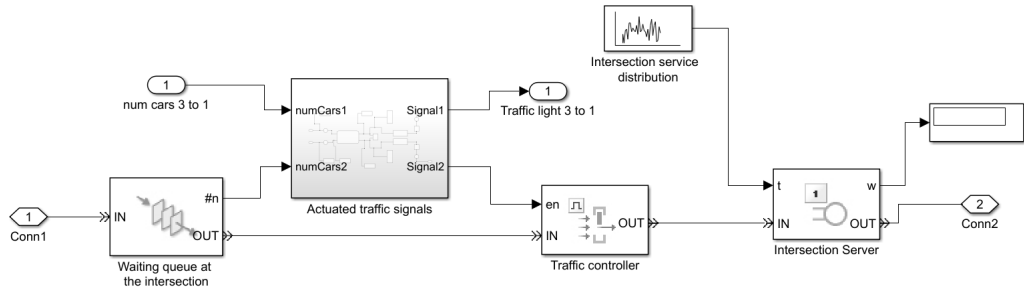

Figure 14: Dynamic traffic light simulation model

predict future congestion rate based on the actual traffic condition. If the estimated congestion rate is above a pre-defined threshold, the traffic controller requests the green light after the minimum red light delay is reached. However, if the intersection is not congested, the red light runs until the maximum red delay is out, then switches to green light. The simulation was performed for a run-time of 1500 seconds. The comparison results are reported in figure 15. We can observe that the two curves follow similar trends. However, the average waiting time is significantly low for the dynamic traffic model.

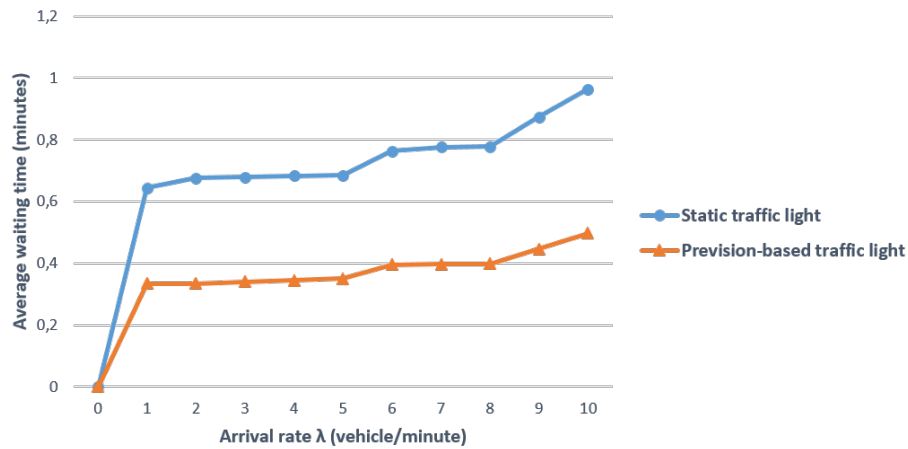

Figure 15: Average waiting time: Pre-timed traffic light vs Actuated traffic light

The speed control policy is implemented in SimEvent environment as de-

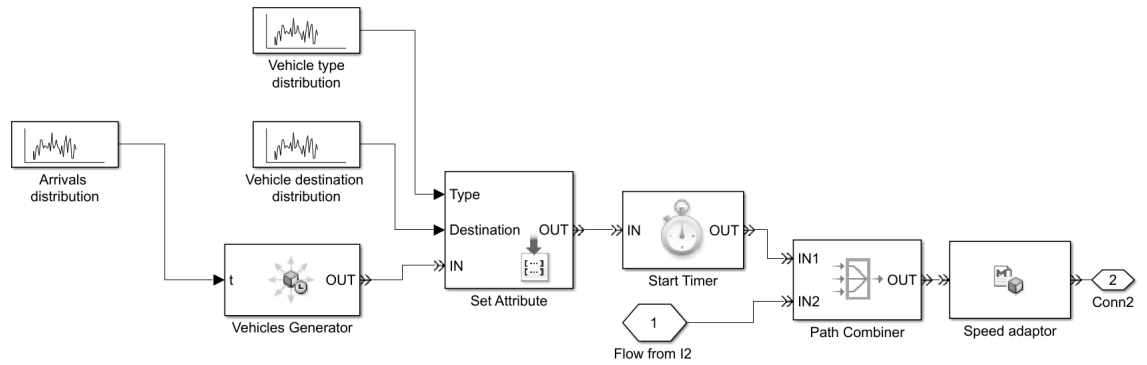

Figure 16: Speed control simulation model

470 pictured in figure 16. The attribute function automatically controls the travel velocity of vehicles. If the estimated congestion rate exceeds the threshold, the minimum allowed speed is continuously increased until the congestion rate falls below the threshold. The simulation was run for 200 seconds and results are shown in figure 17. The graphs demonstrates that a prediction based speed controller can help substantially reduce delays, particularly when more vehicles are generated.

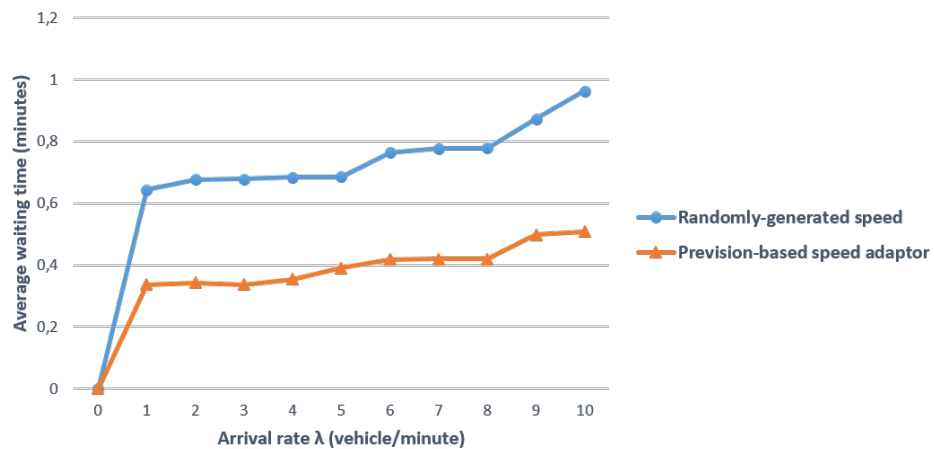

Figure 17: Average travel delay: Random travel speed vs Actuated speed controller

To sum up, in this section we tested the mobility model for a set of configurations by varying parameters that may affect the system's performance. The results show that the model maps out the real-world mobility aspects. To validate the model, we chose to use the traffic predictions to construct a congestion aware traffic light and speed adaptor. The simulation results confirm that the proposed approach is a promising solution to improve queuing and reduce delays brought on by congestion.

## 5. Conclusion

In this study a stochastic mobility model for urban environments was developed. The approach applies queuing theory principles to represent the traffic scenario in multiple-lane roads and junctions. The system behavior is then modeled as Markov chain to forecast the long-run average quantities such as congestion rates and average waiting times in order to analyse the performance of the system. Numerical results were derived for a set of configurations by varying parameters that may affect the performance of the system. In order to prove the validity of the model, the inferred results were compared with a queue-based model and realistic traces. The numerical results show that the model accurately reflects the real world urban traffic behaviour when historical traffic information are used. The importance of the proposed model is showcased by designing a congestion-aware traffic light system and a vehicle speed controller. The findings clearly show that traffic prevision is a promising solution to improve traffic efficiency and to reduce delays brought on by congestion. Future work is planned to apply the proposed model to mitigate the fairness issue in radio resources allocation in IEEE 802.11p-based vehicular networks.

## References

- [1] A. Reyes-Muñoz, M. C. Domingo, M. A. López-Trinidad, J. L. Delgado, Integration of body sensor networks and vehicular ad-hoc networks for traffic safety, *Sensors* 16 (1) (2016) 107.

- [2] C.-C. Lin, D.-J. Deng, Optimal two-lane placement for hybrid vanet-sensor networks, *IEEE Transactions on Industrial Electronics* 62 (12) (2015) 7883–7891.
- [3] F. Losilla, A. J. García-Sánchez, F. García-Sánchez, J. García-Haro, On the role of wireless sensor networks in intelligent transportation systems, in: 2012 14th International Conference on Transparent Optical Networks (ICTON), IEEE, 2012, pp. 1–4.
- [4] O. S. Oubbati, N. Chaib, A. Lakas, P. Lorenz, A. Rachedi, Uav-assisted supporting services connectivity in urban vanets, *IEEE Transactions on Vehicular Technology* 68 (4) (2019) 3944–3951.
- [5] L. Xiao, X. Lu, D. Xu, Y. Tang, L. Wang, W. Zhuang, Uav relay in vanets against smart jamming with reinforcement learning, *IEEE Transactions on Vehicular Technology* 67 (5) (2018) 4087–4097.
- [6] H. El-Sayed, M. Chaqfeh, The deployment of mobile edges in vehicular environments, in: 2018 International Conference on Information Networking (ICOIN), IEEE, 2018, pp. 322–324.
- [7] Y. Li, K. Ying, P. Cheng, H. Yu, H. Luo, Cooperative data dissemination in cellular-vanet heterogeneous wireless networks, in: 2012 4th International High Speed Intelligent Communication Forum, IEEE, 2012, pp. 1–4.
- [8] C. Lai, D. Zheng, Q. Zhao, X. Jiang, Segm: A secure group management framework in integrated vanet-cellular networks, *Vehicular Communications* 11 (2018) 33–45.
- [9] I. Lana, J. Del Ser, M. Velez, E. I. Vlahogianni, Road traffic forecasting: Recent advances and new challenges, *IEEE Intelligent Transportation Systems Magazine* 10 (2) (2018) 93–109.
- [10] E. I. Vlahogianni, M. G. Karlaftis, J. C. Golias, Short-term traffic forecasting: Where we are and where we’re going, *Transportation Research Part C: Emerging Technologies* 43 (2014) 3–19.



- [11] F. J. Ros, J. A. Martinez, P. M. Ruiz, A survey on modeling and simulation of vehicular networks: Communications, mobility, and tools, *Computer Communications* 43 (2014) 1–15.
- [12] F. Xia, A. Rahim, X. Kong, M. Wang, Y. Cai, J. Wang, Modeling and analysis of large-scale urban mobility for green transportation, *IEEE Transactions on Industrial Informatics* 14 (4) (2018) 1469–1481. doi: 10.1109/TII.2017.2785383.
- 540 [13] A. Afdhal, A. Ahmadiar, N. Nasaruddin, V2v mobility modeling and simulation using pbc messages for traffic congestion mitigation, in: 2018 IEEE International Conference on Communication, Networks and Satellite (Comnetsat), IEEE, 2018, pp. 28–33.
- [14] N. Akhtar, S. C. Ergen, O. Ozkasap, Vehicle mobility and communication channel models for realistic and efficient highway vanet simulation, *IEEE Transactions on Vehicular Technology* 64 (1) (2014) 248–262.
- [15] S. Kamakshi, V. S. Sriram, Modularity based mobility aware community detection algorithm for broadcast storm mitigation in vanets, *Ad Hoc Networks* (2020) 102161.
- 550 [16] V. A. Davies, Evaluating mobility models within an ad hoc network, Master’s thesis, advisor: Tracy Camp, Dept. of Mathematical and Computer Sci-ences.Colorado School of Mines.
- [17] J. Harri, F. Filali, C. Bonnet, Mobility models for vehicular ad hoc networks: a survey and taxonomy, *IEEE Communications Surveys & Tutorials* 11(4) (2009) 19–41.
- [18] V. Vetriselvi, R. Parthasarathi, Trace based mobility model for ad hoc networks, *Third IEEE International Conference on Wireless and Mobile Computing, Networking and Communications (WiMob 2007)* (2007) 81–81.

- 560 [19] A. Förster, A. Bin Muslim, A. Udugama, Trails—a trace-based probabilistic mobility model, Proceedings of the 21st ACM International Conference on Modeling, Analysis and Simulation of Wireless and Mobile Systems (2018) 295–302.
- [20] M. G. Beiró, A. Panisson, M. Tizzoni, C. Cattuto, Predicting human mobility through the assimilation of social media traces into mobility models, EPJ Data Science 5 (1) (2016) 30.
- [21] M. Haklay, P. Weber, Openstreetmap: User-generated street maps, IEEE Pervasive Computing 7 (4) (2008) 12–18.
- [22] J. Yeo, D. Kotz, T. Henderson, Crowdad: a community resource for archiving wireless data at dartmouth, ACM SIGCOMM Computer Communication Review 36 (2) (2006) 21–22.
- 570 [23] R. Krajewski, J. Bock, L. Kloeker, L. Eckstein, The highd dataset: A drone dataset of naturalistic vehicle trajectories on german highways for validation of highly automated driving systems, 2018 21st International Conference on Intelligent Transportation Systems (ITSC) (2018) 2118–2125.
- [24] G. D. Cameron, G. I. Duncan, Paramics—parallel microscopic simulation of road traffic, The Journal of Supercomputing 10 (1) (1996) 25–53.
- [25] Q.p. ltd., paramics, <https://www.paramics.co.uk/en/>.
- [26] M.m. technology, traffic software integrated system - corridor simulation, <https://mctrans.ce.ufl.edu/featured/TSIS/>.
- 580 [27] Tss—transport simulation systems, aimsun, tss, <https://www.aimsun.com/>.
- [28] M. Fellendorf, Vissim: A microscopic simulation tool to evaluate actuated signal control including bus priority 32 (1994) 1–9.
- [29] Vissim america, <https://www.ptvgroup.com/>.

- [30] P. A. Lopez, M. Behrisch, L. Bieker-Walz, J. Erdmann, Y.-P. Flötteröd, R. Hilbrich, L. Lücken, J. Rummel, P. Wagner, E. WieBner, Microscopic traffic simulation using sumo, in: 2018 21st International Conference on Intelligent Transportation Systems (ITSC), IEEE, 2018, pp. 2575–2582.
- 590 [31] Sumo homepage <https://www.eclipse.org/sumo/>.
- [32] M. Fiore, J. Harri, F. Filali, C. Bonnet, Vehicular mobility simulation for vanets (2007) 301–309.
- [33] Vanetmobisim 1.1, <http://vanet.eurecom.fr/>.
- [34] M. J. Lighthill, G. B. Whitham, On kinematic waves ii. a theory of traffic flow on long crowded roads, Proceedings of the Royal Society of London. Series A. Mathematical and Physical Sciences 229 (1178) (1955) 317–345.
- [35] P. I. Richards, Shock waves on the highway, Operations research 4 (1) (1956) 42–51.
- 600 [36] H. X. Liu, X. Wu, W. Ma, H. Hu, Real-time queue length estimation for congested signalized intersections, Transportation research part C: emerging technologies 17 (4) (2009) 412–427.
- [37] H. Yang, H. Rakha, M. V. Ala, Eco-cooperative adaptive cruise control at signalized intersections considering queue effects, IEEE Transactions on Intelligent Transportation Systems 18 (6) (2016) 1575–1585.
- [38] F. Bai, N. Sadagopan, A. Helmy, The important framework for analyzing the impact of mobility on performance of routing protocols for adhoc networks, Ad hoc networks 1 (4) (2003) 383–403.
- [39] K. Nagel, M. Schreckenberg, A cellular automaton model for freeway traffic, Journal de physique I 2 (12) (1992) 2221–2229.
- 610 [40] G. Zhang, W. Xu, Cellular automaton traffic model considering driver’s reaction to velocity and headway distance with variable possibility of randomization, MS&E 392 (6) (2018) 062024.

- [41] L. Briesemeister, Group membership and communication in highly mobile ad hoc networks.
- [42] S. Krauß, Microscopic modeling of traffic flow: Investigation of collision free vehicle dynamics.
- [43] M.-D. Pop, O. Proştean, G. Proştean, Multiple lane road car-following model using bayesian reasoning for lane change behavior estimation: A smart approach for smart mobility (2019) 1–8.
- 620 [44] F. Legendre, V. Borrel, M. D. De Amorim, S. Fdida, Modeling mobility with behavioral rules: The case of incident and emergency situations (2006) 186–205.
- [45] P. G. Gipps, A behavioural car-following model for computer simulation, *Transportation Research Part B: Methodological* 15 (2) (1981) 105–111.
- [46] S. Kharrazi, M. Almén, E. Frisk, L. Nielsen, Extending behavioral models to generate mission-based driving cycles for data-driven vehicle development, *IEEE Transactions on Vehicular Technology* 68 (2) (2018) 1222–1230.
- [47] C. Gawron, An iterative algorithm to determine the dynamic user equilibrium in a traffic simulation model, *International Journal of Modern Physics C* 9 (03) (1998) 393–407.
- 630 [48] P. B. Mirchandani, N. Zou, Queuing models for analysis of traffic adaptive signal control, *IEEE Transactions on Intelligent Transportation Systems* 8 (1) (2007) 50–59.
- [49] M. Cremer, M. Landefeld, A mesoscopic model for saturated urban road networks 97 (1997) 169–180.
- [50] G. H. Mohimani, F. Ashtiani, A. Javanmard, M. Hamdi, Mobility modeling, spatial traffic distribution, and probability of connectivity for sparse and dense vehicular ad hoc networks, *IEEE Transactions on Vehicular Technology* 58 (4) (2008) 1998–2007.

- 640 [51] E. Harahap, J. Wijekoon, P. Purnamasari, D. Darmawan, R. Ceha, H. Nishi, Improving road traffic management by a model-based simulation (2018) 1–6.
- [52] R. Ketabi, M. Al-Qathrady, B. Alipour, A. Helmy, Vehicular traffic density forecasting through the eyes of traffic cameras; a spatio-temporal machine learning study, in: Proceedings of the 9th ACM Symposium on Design and Analysis of Intelligent Vehicular Networks and Applications, 2019, pp. 81–88.
- [53] D. Xia, H. Li, B. Wang, Y. Li, Z. Zhang, A map reduce-based nearest neighbor approach for big-data-driven traffic flow prediction, IEEE access 4 (2016) 2920–2934.
- 650 [54] F. Jin, S. Sun, Neural network multitask learning for traffic flow forecasting, in: 2008 IEEE International Joint Conference on Neural Networks (IEEE World Congress on Computational Intelligence), IEEE, 2008, pp. 1897–1901.
- [55] B. O. J. E. J. Oumaima, V. Véronique, Continuous time markov chain traffic model for urban environments, GLOBECOM 2020 - 2020 IEEE Global Communications Conference (2020) pp. 1–6.
- [56] F. Gunes, S. Bayrakli, A. H. Zaim, Flow characteristics of traffic flow at signalized intersections and performance comparison using queueing theory 660 (2020) 1–9.
- [57] C. Wang, Study on toll plaza design based on m/m/1 queue theory.
- [58] J. Barrachina, J. A. Sanguesa, M. Fogue, P. Garrido, F. J. Martinez, J.-C. Cano, C. T. Calafate, P. Manzoni, V2x-d: A vehicular density estimation system that combines v2v and v2i communications, in: 2013 IFIP Wireless Days (WD), IEEE, 2013, pp. 1–6.
- [59] B. L. Nguyen, D. T. Ngo, N. H. Tran, H. L. Vu, Combining v2i with v2v communications for service continuity in vehicular networks, in: 2019

IEEE Intelligent Transportation Systems Conference (ITSC), IEEE, 2019, pp. 201–206.

- 670 [60] T. Sukuvaara, P. Nurmi, Wireless traffic service platform for combined vehicle-to-vehicle and vehicle-to-infrastructure communications, *IEEE Wireless Communications* 16 (6) (2009) 54–61.
- [61] G. H. Mohimani, F. Ashtiani, A. Javanmard, M. Hamdi, Mobility modeling, spatial traffic distribution, and probability of connectivity for sparse and dense vehicular ad hoc networks, *IEEE Transactions on Vehicular Technology* 58 (4) (2008) 1998–2007.
- [62] M. A. Kafi, J. B. Othman, L. Mokdad, N. Badache, Performance analysis and evaluation of refiacc using queuing networks, *Simulation Modelling Practice and Theory* 71 (2017) 15–26.
- 680 [63] L. Mokdad, J. Ben-Othman, A. T. Nguyen, Djavan: Detecting jamming attacks in vehicle ad hoc networks, *Performance Evaluation* 87 (2015) 47–59.
- [64] W. K. Grassmann, M. I. Taksar, D. P. Heyman, Regenerative analysis and steady state distributions for markov chains, *Operations Research* 33 (5) (1985) 1107–1116.
- [65] B. O. Jalel, V. Véronique, et al., Queuing theory based simulation model for vehicular mobility, in: *ICC 2021-IEEE International Conference on Communications*, IEEE, 2021, pp. 1–6.
- [66] J. Bock, R. Krajewski, T. Moers, S. Runde, L. Vater, L. Eckstein, The ind  
690 dataset: A drone dataset of naturalistic road user trajectories at german intersections, 2019.
- [67] R. Krajewski, T. Moers, J. Bock, L. Vater, L. Eckstein, The round dataset: A drone dataset of road user trajectories at roundabouts in germany, submitted.