



HAL
open science

Influence of Dielectric Barrier Discharge treatment on the triboelectric charging and the electrostatic separation of plastic particles

Gontran Richard, Ahlem Benabderrahmane, Karim Medles, Thami Zeghloul,
Lucien Dascalescu

► **To cite this version:**

Gontran Richard, Ahlem Benabderrahmane, Karim Medles, Thami Zeghloul, Lucien Dascalescu. Influence of Dielectric Barrier Discharge treatment on the triboelectric charging and the electrostatic separation of plastic particles. 2018 Electrostatics Joint Conference, Boston University, U.S.A., June 17-20, Jun 2018, Boston, France. pp.D3 1-13. <hal-04429219>

HAL Id: hal-04429219

<https://hal.science/hal-04429219v1>

Submitted on 31 Jan 2024

HAL is a multi-disciplinary open access archive for the deposit and dissemination of scientific research documents, whether they are published or not. The documents may come from teaching and research institutions in France or abroad, or from public or private research centers.

L'archive ouverte pluridisciplinaire **HAL**, est destinée au dépôt et à la diffusion de documents scientifiques de niveau recherche, publiés ou non, émanant des établissements d'enseignement et de recherche français ou étrangers, des laboratoires publics ou privés.



HAL Authorization

Influence of Dielectric Barrier Discharge treatment on the triboelectric charging and the electrostatic separation of plastic particles

Gontran Richard^{1,2}, Ahlem Benabderrahmane¹, Karim Medles¹, Thami Zeghloul¹,
Lucian Dascalescu¹

¹PPRIME Institute, CNRS – University of Poitiers – ENSMA, Angoulême, France

²CITF company, Dorgeville, St Cybardeaux, France

e-mail: lucian.dascalescu@univ-poitiers.fr

Abstract—Effective triboelectric charging is a prerequisite of the successful electrostatic separation of granular insulating materials. If the triboelectric effect imparted them high levels of charge of opposite polarities, the particles can be easily separated in a high-intensity electric field. The dielectric barrier discharge (DBD), commonly used for ozone production, air depollution or surface treatment is able to change the triboelectric properties of plastics. Depending on the conditions of DBD treatment (amplitude and frequency of the voltage applied to the electrode system, the duration of the exposure...) the triboelectric charge of plastics can be improved or decreased. The aim of this study is to compare the results of triboelectric charging and electrostatic separation of DBD-treated and untreated plastic particles originating from WEEE. Triboelectric series were established for nine different plastics (ABS, HIPS, PC, Cristal PC, PE, PP, PS, Cristal PS and PVC) using a rotating cylinder tribocharging device. The cylinder of the device was made of either High-Density Polyethylene (HDPE) or Polyvinyl Chloride (PVC). The separation experiments were carried out on a roll-type electrostatic separator. The effects of DBD on plastic particles charging were very significant. Most of the studied plastics got a negative tribocharge after having been treated by DBD, whereas five or six of them were positively charged without DBD treatment, depending on the type of the cylinder of the tribocharging device. The modification of the triboelectric behavior highly affects the electrostatic separation of the six different mixtures that were tested: PE-HIPS, PE-PP, PE-PVC, PP-HIPS, PP-PVC and PVC-HIPS.

I. INTRODUCTION

The triboelectric effect still represents the object of numerous scientific investigations, more or less related to its potential use as a charging mechanism in several electrostatic applications, such as: triboelectric sensors [1], [2], energy harvesting [3], [4], electrostatic separation of granular polymers [5]-[7]... In each application, the charge acquired by the materials has a major influence on the outcome of the process. Therefore, it is important to improve the tribocharging capability of the processed materials [8].

The electrostatic separation of granular insulating mixtures depends on the combined action of mechanical and electrical forces [9]. Therefore, the granules charge should be as high as possible so that the electric attraction force (Coulomb force) could overcome the gravitational and centrifugal forces. Previous studies on the improvement and the optimization of tribocharging devices and their operations were carried out in relation with various electrostatic separation applications [10], [11].

Tribocharging is a surface phenomenon. Therefore, it is likely to be affected by plasma treatment processes, which are known to change the surface state of insulating materials [12-15]. The exposure of PP and PE particles to a dielectric barrier discharge (DBD) [16], [17] was shown to have an important influence on their triboelectric behavior. Of the different parameters of the DBD, treatment duration is one of the most influencing.

For short exposures to DBD (inferior to 10 s), the capability of the particles to get triboelectric charge increase a lot compared to untreated particles; for longer durations, the charge highly decreases. The frequency of the AC high-voltage applied to the electrodes of the DBD reactor has little influence on the outcome of the tribocharging. Conversely, the increase of the voltage amplitude enhances the tribocharging effect. Moreover, square signal has more effect on the tribocharging properties of the particles than the sinusoidal or triangular waveforms.

The aim of this paper is to compare the triboelectric series of nine types of granular polymers with and without DBD treatment. Then, electrostatic separation experiments have been made to evaluate the effect of DBD on the separation of six mixtures.

II. MATERIALS AND METHODS

To improve electrostatic separation of some insulator – insulator mixtures, dielectric barrier discharge influence on charge of such particles has been studied. For each experiment particles were firstly submitted to a 3 s atmospheric DBD treatment, then they were placed in a rotating cylinder tribocharging device. Finally, charged particles were introduced in a Faraday pail connected to an electrometer for charge measurement or in a roll-type electrostatic separator for separation experiments.

A. Treated materials

Because electric cables and WEEE are composed of many different plastics, the tribocharging and electrostatic separation experiments were made on many types of granular polymers (Fig. 1): Acrylonitrile Butadiene Styrene (ABS) (*a*), High-Impact Polystyrene (HIPS) (*b*), Polycarbonate (PC) (*c*), Cristal PC (*d*), Polyethylene (PE) (*e*), Polypropylene (PP) (*f*), Polystyrene (PS) (*g*), Cristal PS (*h*) et Polyvinyl chloride (PVC) (*i*).

All these materials have different sizes and shapes which are representative of a potential industrial product. ABS particles are the smallest (average length of 2 mm) and PS particles are the largest (average length of 6 mm). PS and Cristal PS are flat rectangular particles whereas the others are of parallelepiped shape. However, this diversity is expected to affect the results of the experiments because triboelectric charge is a surface phenomenon.

A. Dielectric barrier discharge experimental setup

Particle exposure to the DBD was done with the test bench presented in Fig. 2.

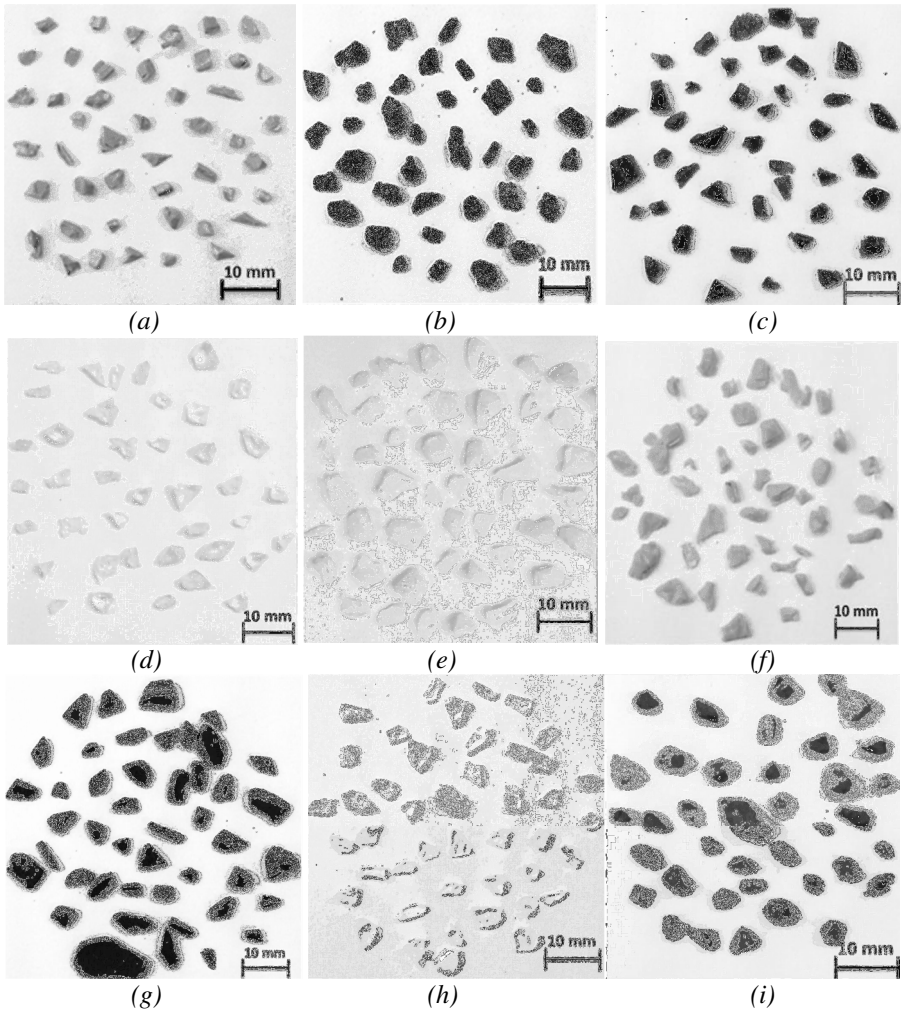

Fig. 1. Photographs of products used for experiments: (a) ABS; (b) HIPS; (c) PC; (d) Cristal PC; (e) PE; (f) PP; (g) PS; (h) PS Cristal and (i) PVC.

In all the experiments, 7 g of particles (maximum mass which can assure a single layer of product in the active zone of the DBD) are placed in a cylindrical PVC support between two square dielectric barriers (glass, 150 mm x 150 mm x 3 mm). These are placed between two aluminum electrodes (diameter: 70 mm).

Bottom electrode is connected to the ground and upper electrode is connected to an AC high voltage amplifier (Trek model 30/20A; amplification ratio 1 V / 3000 V). The AC signal at the input of this amplifier is created by a function generator (Yokogawa FG300) which allows the setting of the waveform (square, sinusoidal or triangular), the frequency (up to 2.5 kHz) and the amplitude of the signal (up to 20 V). The low-voltage signal provided by the generator during this study was a square waveform, with 400 Hz frequency and 14 V amplitude.

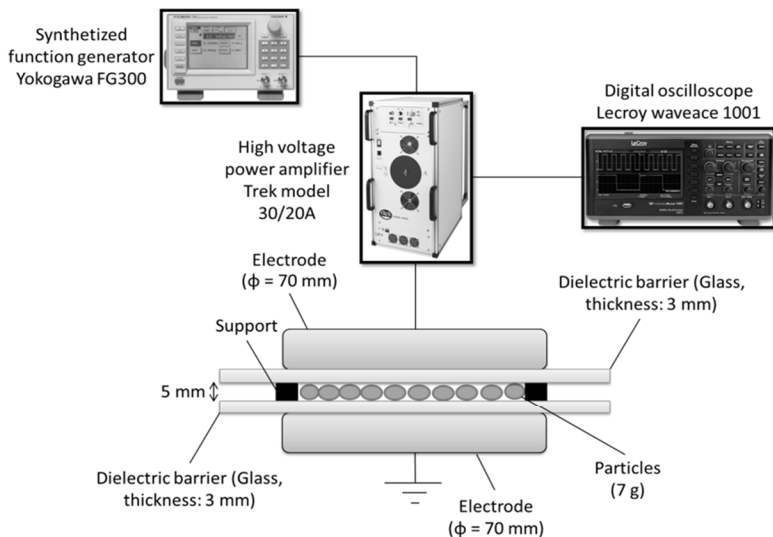

Fig. 2. DBD experimental setup.

Particles were treated for 3 s. Previous studies [16], [17] had shown that these settings increase the acquired triboelectric charge of PP and PE particles. The amplitude of the amplified signal was 42 kV. As the power amplifier was expected to distort the signal, a digital oscilloscope (Lecroy, model Waveace 1001) was employed to display the waveform actually applied to the upper electrode, as well as the effective value of the high-voltage.

B. Rotating cylinder tribocharging device

A rotating cylinder tribocharging device was used to process either DBD-treated or untreated particles (Fig. 3). Particles were introduced in a feeder (1). A valve (2) was used to regulate particle flow rate going through the hollow cylinder (3), having an inner diameter: 120 mm), which charged them. This cylinder is connected to an electric motor (4) the rotating speed of which could be changed up to 113 tr.min^{-1} . Two different hollow cylinders with different materials (PVC or HDPE) can be placed in the device. Their length can be changed (200 mm, 400 mm and 600 mm) and up to 6 blades (10 mm or 15 mm high) can be fixed in the inner wall of the cylinders. Its inclination should be modified from 0° (horizontal) to 45° (5). A full cylinder (6) of the same material can be coaxially introduced in the hollow one. The full cylinder rotates in counter-direction with respect to the hollow one, at a speed up to 40 rpm. The full cylinder and the blades are used to enhance the tribocharging effect by increasing the number of impacts and the length of the sliding trajectories of the particles in the tribocharging device. Output particle flow rate can be set by a hatch. When the hatch is closed product stays in the tribocharging device. Thus, tribocharging duration increases. The charged particles are collected in an output hopper (8), made of the same material as the cylinders.

During this study, both 600 mm cylinders were used (HDPE and PVC) with 6 blades of 15 mm high. Inclination was set at 5° and rotation speed at 85 rpm. These values were determined by preliminary experiments which lead to the highest charge levels of the particles.

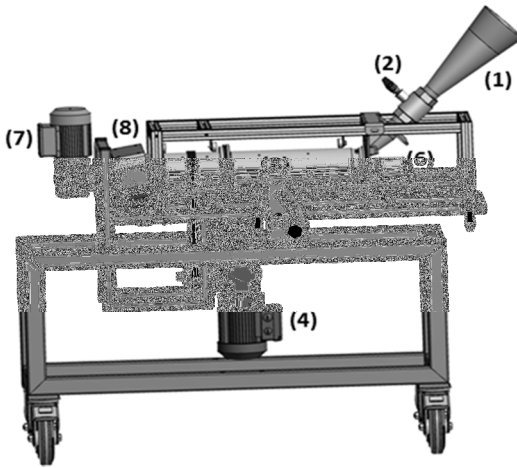

Fig. 3. Rotating cylinder tribocharging device. (1) Feeder; (2) Valve; (3) Hollow cylinder; (4) Electric motor; (5) Inclination system; (6) Full cylinder; (7) Electric motor and (8) Output hopper.

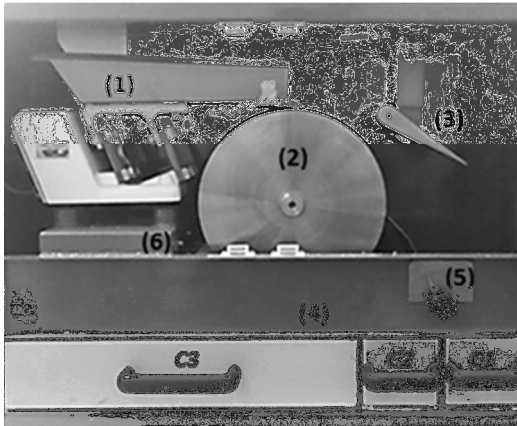

Fig. 4. "Prodecologia" electrostatic separator. (1) Electromagnetic feeder; (2) Grounded rotating roll electrode; (3) NACA profile electrode connected to a reversible high-voltage power supply; (4) Three compartment ($C1$, $C2$ and $C3$) collector; (5) Deflector and (6) Brush.

At the exit of this device, particles can be recovered in a Faraday pail, connected to an electrostatic voltmeter for charge measurement or on an electromagnetic feeder of an electrostatic separator for separation experiments.

C. Roll-type electrostatic separator

To separate charged particles, a roll-type electrostatic separator ("Prodecologia", Rivne, Ukraine) was used (Fig. 4).

The mixture to separate was introduced in the hopper of an electromagnetic feeder (1). Particles were homogeneously fed on a rotating roll electrode connected to the ground (2), the speed of which could be varied between 35 rpm and 80 rpm.

The electric field was created by a second electrode, which has a NACA (National Advisory Committee for Aeronautics) profile, connected to a reversible DC high voltage power supply. ± 35 kV. In the electric field, the charged particles were separated: those with the same polarity as the NACA electrode were pinned to the rotating roll-electrode of opposite polarity, the other were repelled.

The separated particles were recovered in 3 different compartments of the collector (4). A deflector (5), with variable inclination, was placed between the central and right compartments to increase the purity of separated products. Moreover, a brush (6) recovers particles stuck on the cylindrical electrode because of their high charge. For experiments presented in this paper, the third compartment was not taken into account because the product was mainly collected in the two others.

In the electrostatic separation experiments, the particles were first charged in the tribocharging device equipped with the PVC cylinder. The high-voltage applied to NACA electrode was +35 kV and the rotation speed of roll-electrode was 40 rpm.

III. RESULTS AND DISCUSSIONS

First, the effect of DBD on the triboelectric charging of nine types of particles was studied. Then, the feasibility of the electrostatic separation of several binary mixtures of tribocharged particles was evaluated.

A. Triboelectric series

For each cylinder (HDPE and PVC) of the charging device, two series of experiments were made with particles previously exposed to DBD or not. Each experiment was duplicated and the average value of the charge/mass ratio was recorded. In some case a third experiment has been made to consolidate the result.

1) Untreated particles

For untreated particles maximal error was 21.2% for Cristal PS with PVC tube. For all other experiments, maximum error was under 7%. With HDPE cylinder experiments, relative humidity was between 56.8% and 57.3% and the temperature between 23.9°C and 24.2°C. For PVC cylinder, relative humidity was between 45.8% and 50.8% and temperature between 23.9°C and 24.9°C.

With the HDPE cylinder, only three polymers got negatively charged (Fig. 5): PVC, PE and PS. Other particles were positively charged. Highest positive charge was obtained in the case of the ABS particles, with an average value of +261.2 nC per 100 g.

With the PVC cylinder (Fig. 6), similar results were obtained for all particles, with the exception of the PP ones, which switched to negative polarity. Maximal positive charge was acquired by ABS (+612.9 nC), while the negative maximal charge was recorded for the PVC particles (-373.1 nC). The charges were – in absolute values – higher than those obtained with the HDPE tube. Cristal PS always got low levels of charge with both tubes.

One interesting phenomena to note, for both tubes, is that PS particles got negative charges whereas Cristal PS, which have the same nature, acquired positive charges. Moreover, particles of the same matter as the cylinder got negatively charged. Indeed, it is known that in a mixture of particles of different sizes, the smallest ones get negatively charged. Here, the cylinder can be considered as a very big body compared with the size of the particles.

The triboelectric series of the non-DBD treated granular polymers is presented in Fig. 7.

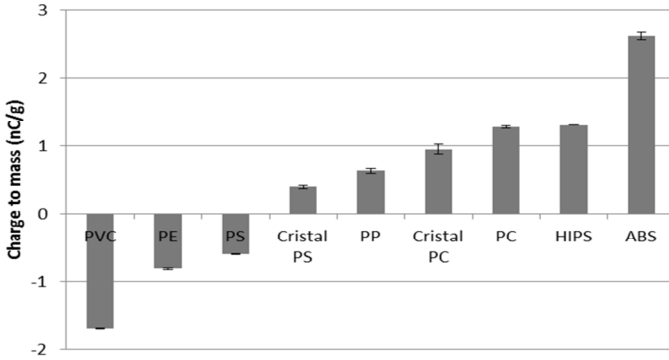

Fig. 5. Charge to mass ratio for nine types of particles passed through HDPE cylinder tribocharging device.

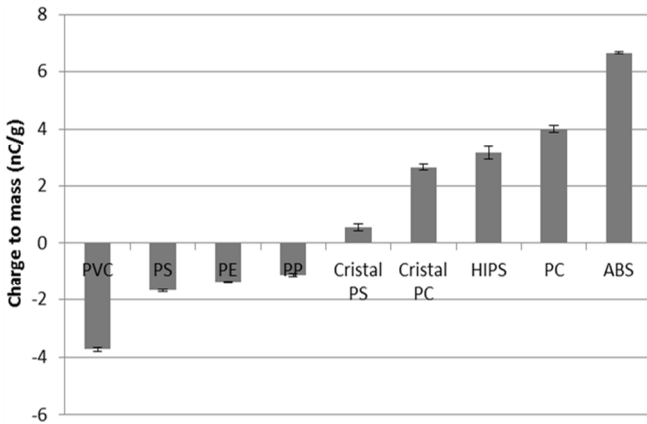

Fig. 6. Charge to mass ratio for nine types of particles passed through PVC cylinder tribocharging device.

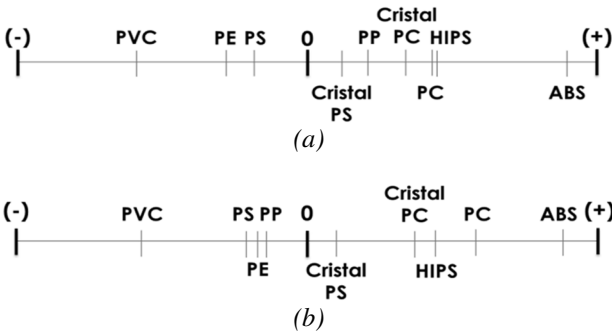

Fig. 7. Triboelectric series obtained for HDPE (a) and PVC (b) cylinder.

2) DBD-treated particles

Triboelectric series were also determined for the same particles after being treated by a DBD (Fig. 8 and Fig. 9). The charge/mass ratios of the particles processed in the HDPE and PVC cylinders were obtained with an experimental error of respectively 3.6% and 1.5%.

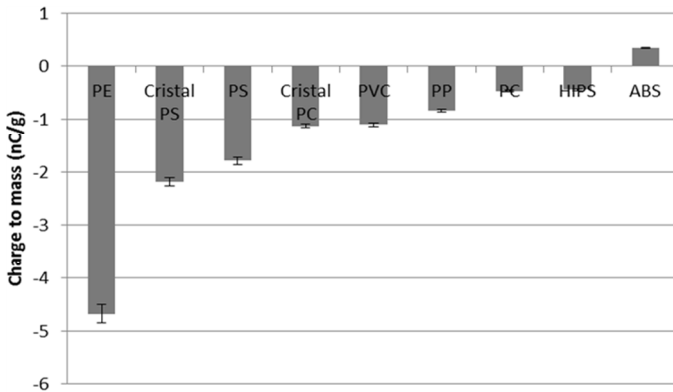

Fig. 8. Charge to mass ratio for nine types of particles pre-treated by DBD and passed through HDPE cylinder tribocharging device.

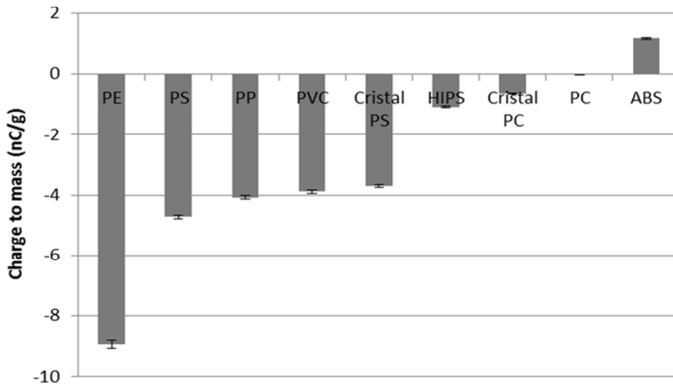

Fig. 9. Charge to mass ratio for nine types of particles pre-treated by DBD and passed through the PVC cylinder tribocharging device.

With HDPE tube, ambient relative humidity was between 53.5% and 57.7% and temperature between 21.2°C and 22.7°C. For PVC tube experiments, relative humidity was between 53.8% and 56.0% and the temperature between 17.1°C and 19.6°C.

After DBD treatment, eight materials get negatively charged in both HDPE and PVC cylinders. ABS is the only DBD-treated material that acquires positive charge, but at a lower level than when untreated (1.2 nC.g^{-1} against 6.1 nC.g^{-1} without DBD treatment, when using the PVC cylinder). The untreated particles that acquire a negative charge when tribocharged get a higher absolute charge after DBD treatment (except PVC whose charge stays the approximately the same).

With HDPE cylinder, DBD-treated Cristal PS got one of the highest negative charge, in absolute value (-2.2 nC.g^{-1}) whereas it was uncharged when not pre-exposed to DBD (0.4 nC.g^{-1}). A Cristal PS – PP separation, complicated without DBD treatment (both materials are weakly positively charged), is possible when they are treated because the difference of charge between them is important enough even if they are both negatively charged.

However, PP – PVC separation is more difficult when particles are pre-treated in a DBD. In this case, both get a negative charge in the tribocharger, whereas their polarities are opposite to each-other when not pre-exposed to DBD.

With the PVC cylinder, particle charges were negative and their absolute value higher than with the HDPE cylinder. Only ABS got a weak positive charge. PE charge increased when pre-treated by DBD up to -8.9 nC.g^{-1} , which represent 2.4 times its charge without DBD. However, PC particles charge was approximatively null. The charge gap between PP, PVC and Cristal PS is small so their separation might be difficult.

Several phenomena could explain this tendency of the particles to get a negative charge after been treated by DBD: generation of new chemical species, modification of hydrophobicity, alteration of surface roughness, but further studies should be made to validate these hypotheses.

B. Electrostatic separation

Tests were made to study the influence of DBD on electrostatic separation of six granular mixtures: PVC – HIPS; PE – PVC; PE – HIPS; PP – PVC; PE – PP; PP – HIPS.

1) Untreated particles

During these tests the relative humidity ranged from 62.0% to 64.2% and the temperature from 24.4°C and 24.8°C. The results obtained for untreated particles are presented in figure 10.

The PVC – HIPS separation was very efficient. Thus, 94.7% of the PVC was recovered with a purity of 99.8% and the 95.2% HIPS recovery was attained for a purity of 94.9% (Fig. 10 (a)). Triboelectric series explain this efficient separation because PVC gets a high negative charge and HIPS a high positive charge in contact with PVC cylinder. Thus, PVC is strongly attracted by NACA electrode whereas HIPS is repulsed (Fig. 6).

The PE – PVC separation (Fig. 10 (b)) was less efficient because both materials got negatively charged in contact with the PVC cylinder of the tribocharging device (Fig. 6). However, the PP – PVC mixture, composed of two materials that both charged negatively, was efficiently separated (Fig. 10 (b)). Indeed, PP charges less than PE so it less attracted, which explains the better separation results.

The PP – PE mixture, also composed of two products that got a negative charge in the tribocharging device, had a slightly different behavior (Fig. 10 (e)). The PE particles acquired less charge than the PP ones. Thus, the recovery of PE is low (65.7%) but its purity high (95.4%), as the better charged PP particles will be better attracted to the opposite electrode. PP purity, in compartment C2, was poor because some PE particles were not charged enough to be collected in compartment C1.

It can be concluded that the separation of two types of particles having the same polarity is possible if the charge difference between them is large enough.

Two other mixtures were difficult to separate, in spite of the fact that their components were oppositely charged: PE – HIPS (Fig. 10 (c)) and PP – HIPS (Fig. 10 (f)). According to the triboelectric series (Fig. 6), HIPS got a high positive charge ($+314.9 \text{ nC per } 100 \text{ g}$) and PP and PE acquired a relatively low negative charge (respectively -111.1 nC and -135.4 nC) in the tribocharging device. The attractive action of the high voltage NACA electrode of positive polarity was exerted on the less charged particles (negative ones) which explain these bad results. A negative polarity applied to the high-voltage electrode should give better results.

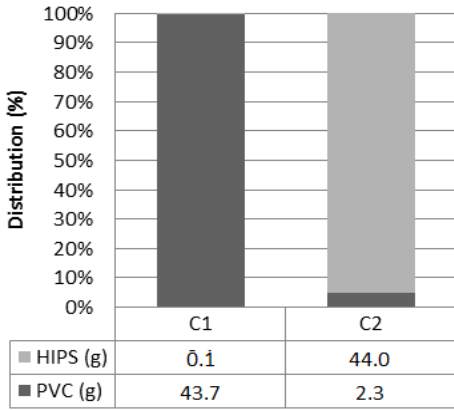

(a)

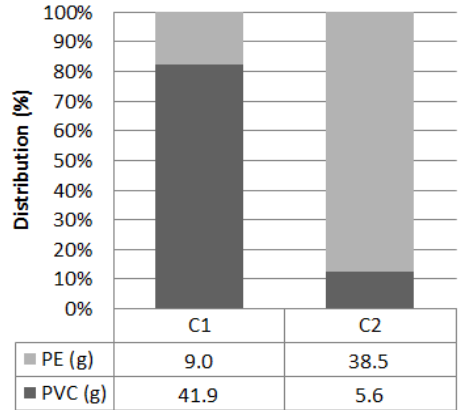

(b)

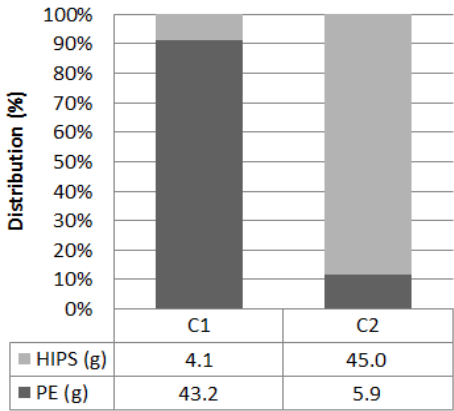

(c)

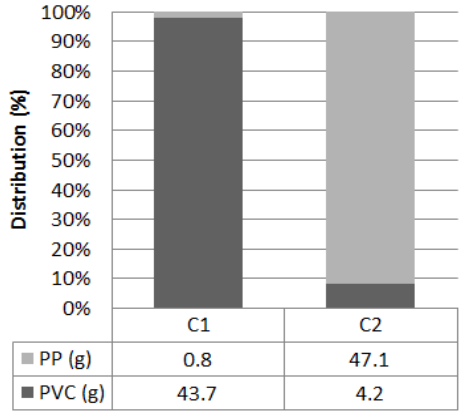

(d)

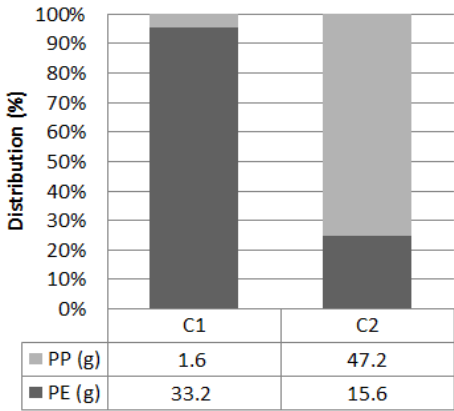

(e)

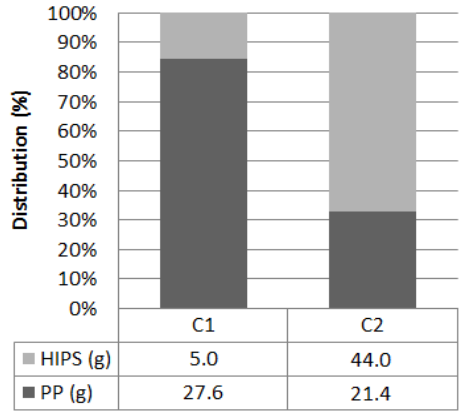

(f)

Fig. 10. Particles repartition in the two compartments of the collector for non-DBD-treated granular mixtures (a) PVC-HIPS; (b) PE-PVC; (c) PE-HIPS; (d) PP-PVC; (e) PE-PP and (f) PP-HIPS.

2) DBD treated particles

During these tests, the ambient relative humidity ranged between 57.0% and 58.6% and temperature between 17.9°C and 19.1°C.

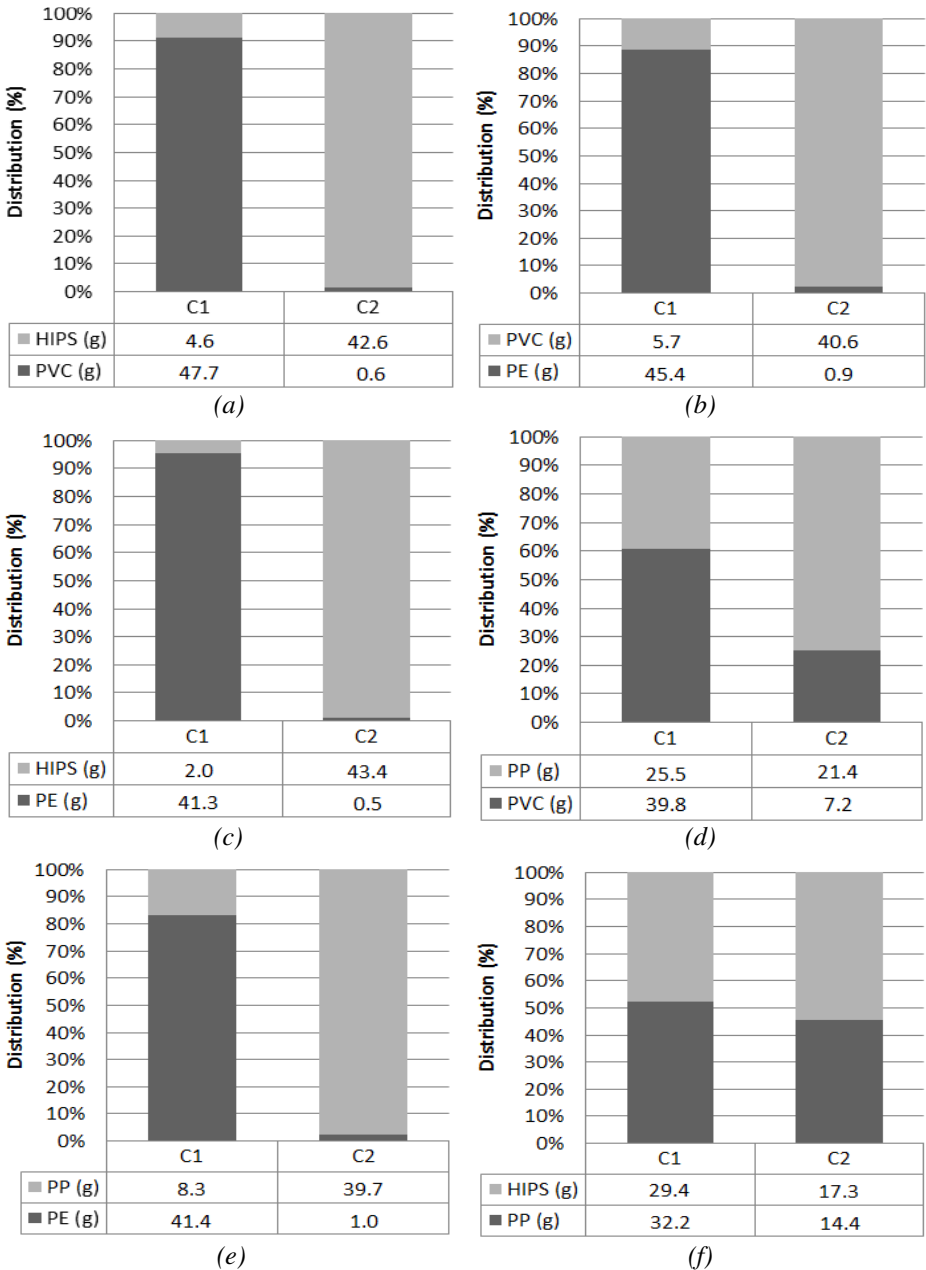

Fig. 11. Particles repartition in the two compartments of the collector for DBD-treated granular mixtures (a) PVC-HIPS; (b) PE-PVC; (c) PE-HIPS; (d) PP-PVC; (e) PE-PP and (f) PP-HIPS.

The DBD exposure of the particles had an important influence on the tribo-electrostatic separation results (Fig. 11). For all PE mixtures (Fig. 11 (b), (c) and (e)), the other type of particles, collected in compartment C2, had purities higher than 97.5%. PE purity, collected in compartment C1, exceeded 95% for PE – HIPS separation. In the other cases, the PP and PVC got a higher negative charge than HIPS so they were attracted with PE. As a consequence, the PE purity decreased. Reducing the voltage would certainly increase PE purity to the detriment of the other types of product.

The PP – HIPS separation was poor (Fig. 11 (f)). This result seems to contradict the previously tribocharging experiments, as the two products were found to be distanced in the triboelectric series (3.0 nC.g^{-1} in absolute value). However, it seems that the particle-particle collisions modified the expected charging state of the two materials and lead to an unsatisfactory separation result.

As it could have been predicted by the triboelectric series (Fig. 9), the PP and PVC particles separation was not effective (Fig. 11 (d)) because charge gap between them is narrow.

Finally, the granular mixture of PVC – HIPS (two materials occupying distant positions in the triboelectric series) was successful (Fig. 11 (a)). A slight decrease of the voltage could further improve the separation efficiency by attracting fewer HIPS in the C1 compartment.

IV. CONCLUSION

This study had the objective to show the influence of Dielectric Barrier Discharge on triboelectric charging and electrostatic separation of granular polymers. Triboelectric series were determined for nine types of polymers and pointed out an important influence of DBD treatment. Indeed, after DBD exposure and tribocharging, regardless of cylinder material, eight of the nine types of particles get negatively charged, whereas only three or four polymers charged negatively without DBD treatment. Moreover, electrostatic separation is also highly influenced by DBD treatment of particles. In some cases, separation is improved and in other cases separation is degraded according to the modifications in triboelectric series.

Another study should be made to better understand the mechanisms which rule the influence of DBD on polymer particles tribocharging compartment, in relation with the surface chemical and physical characteristics of the polymers before and after DBD treatment.

REFERENCES

- [1] Y. Su, G. Zhu, W. Yang, J. Yang, J. Chen, Q. Jing, Z. Wu, Y. Jiang and Z. L. Wang, "Triboelectric sensor for self-powered tracking of object motion inside tubing," *ACS Nano*, vol. 8, 2014, pp. 3843-3850.
- [2] F. Yi, L. Lin, S. Niu, J. Yang, W. Wu, S. Wang, Q. Liao, Y. Zhang and Z. L. Wang, "Self-powered trajectory, velocity, and acceleration tracking of a moving object/body using a triboelectric sensor," *Advanced Functional Materials*, vol. 24, 2014, pp. 7488-7494.
- [3] B.K. Yun, J.W. Kim, H.S. Kim, K.W. Jung, Y. Yi, M.S. Jeong, J.H. Ko and J.H. Jung, "Base-treated polydimethylsiloxane surfaces as enhanced triboelectric nanogenerators," *Nano Energy*, vol. 15, 2015, pp. 523-529.
- [4] P. Bai, G. Zhu, Y.S. Zhou, S. Wang, J. Ma, G. Zhang and Z.L. Wang, "Dipole-moment-induced effect on contact electrification for triboelectric nanogenerators," *Nano Res.*, vol. 7, 2014, pp. 990-997.

- [5] A. Iuga, A. Samuila, R. Morar, M. Bilici and L. Dascalescu, "Tribocharging techniques for the electrostatic separation of granular plastics from waste electric and electronic equipment," *Part. Sci. Technol.*, vol. 34, 2016, pp. 45–54.
- [6] G. Buda, A. Samuila, S. Atroune, M. Bilici and L. Dascalescu, "Set point identification of a tribocharging process for mixed granular solids," *J. Electrostat.*, vol. 71, 2013, pp. 407–412.
- [7] M. Miloudi, K. Medles, A. Tilmatine, M. Brahami and L. Dascalescu, "Modeling and optimization of a propeller-type tribocharger for granular materials," *J. Electrostat.*, vol. 69, 2011, pp. 631–637.
- [8] W.D. Greason, I.M. Oltean, Z. Kucеровsky and A.C. Ieta, "Triboelectric charging between polytetrafluoroethylene and metals," *IEEE Trans. Ind. Appl.*, vol. 40, 2004, pp. 442–450.
- [9] M. Remadnia, M. Kachi, S. Messal, A. Oprean, X. Rouau and L. Dascalescu, "Electrostatic separation of peeling and gluten from finely ground wheat grains," *Part. Sci. Technol.*, vol. 32, 2014, pp. 608–615.
- [10] A. Mekhalef Benhafssa, S. Messal, K. Medles, T. Zeghloul and L. Dascalescu, "Factors that influence the efficiency of a propeller-type tribocharging device for granular plastics," *IEEE Trans. Ind. Appl.*, vol. 53, 2017, pp. 1446–1451.
- [11] J. Li, G. Wu and Z. Xu, "Tribo-charging properties if waste plastic granules in process of tribo-electrostatic separation," *Waste Management*, vol. 35, 2015, pp. 36–41.
- [12] K. L. Mittal and D. J. Beebe, *Polymer Surface Modification: Relevance to Adhesion*, vol. 3, VSP Utrecht (Boston), 2004, pp 1–487.
- [13] C. S. Ren, K. Wang, Q. Y. Nie, D. Z. Wang and S. H. Guo, "Surface modification of PE film by DBD plasma in air," *Appl. Surf. Sci.*, vol. 255, 2008, pp. 3421–3425.
- [14] M. Thomas and K. L. Mittal, *Atmospheric Pressure Plasma Treatment of Polymers Relevance to Adhesion*, Scrivener Publishing LLC Wiley (Beverly Ma), 2013, pp 1–395.
- [15] H. Zhang, H. Li, M. Fang, Z. Wang, L. Sang, L. Yang and Q. Chen, "Roll-to-roll DBD plasma pretreated polyethylene web for enhancement of Al coating adhesion and barrier property," *Appl. Surf. Sci.*, 2015, pp. 1–7.
- [16] G. Richard, A. Benabderrahmane, K. Medles, A. Tilmatine, T. Zeghloul and L. Dascalescu, "Factors that affect tribocharging of PE granules after exposure to a dielectric barrier discharge (DBD)," presented at *2017 IEEE Industry Applications Society Annual Meeting*, Cincinnati, OH (U.S.A.), October 1–5, 2017.
- [17] G. Richard, A. Nadjem, K. Medles, M. Kachi, T. Zeghloul and L. Dascalescu, "Tribocharging of PP granules after exposure to a Dielectric Barrier Discharge (DBD). Effect of exposure duration, voltage amplitude and frequency," presented at *2017 Annual Meeting of the Electrostatics Society of America*, Ottawa (Canada), June 13–15, 2017.