



HAL
open science

Communicating materials: Communicating concrete development for construction industry

Michaël David, William Derigent, Gaël Loubet, Alexandru Takacs, Daniela Dragomirescu

► To cite this version:

Michaël David, William Derigent, Gaël Loubet, Alexandru Takacs, Daniela Dragomirescu. Communicating materials: Communicating concrete development for construction industry. IEEE Transactions on Industrial Informatics, 2024, 20 (4), pp.6983-6994. 10.1109/tii.2024.3352261 . hal-04428096

HAL Id: hal-04428096

<https://hal.science/hal-04428096>

Submitted on 31 Jan 2024

HAL is a multi-disciplinary open access archive for the deposit and dissemination of scientific research documents, whether they are published or not. The documents may come from teaching and research institutions in France or abroad, or from public or private research centers.

L'archive ouverte pluridisciplinaire **HAL**, est destinée au dépôt et à la diffusion de documents scientifiques de niveau recherche, publiés ou non, émanant des établissements d'enseignement et de recherche français ou étrangers, des laboratoires publics ou privés.

Communicating Materials: Communicating Concrete Development for Construction Industry

M. David, W. Derigent, G. Loubet, A. Takacs, D. Dragomirescu

Abstract—This paper presents the design of communicating materials and their application to sensing communicating concrete for construction industry. After presenting the concept of communicating materials and its issues in the context of the construction and Structure Health Monitoring, this article depicts the main contributions made so far in the physical development of a communicating concrete expected to be functional more than three decades. To obtain it, a specific cyber-physical architecture is proposed, using a two-level Wireless Sensor Network with Sensing and Communicating Nodes. To maximize the lifetime of the communicating concrete, the energy conservation problem is improved with two proposals: an original energy harvesting system using Wireless Power Transfer for embedded Sensing Nodes and analytical estimation models for predicting energy consumption of the Communicating Nodes network.

Index Terms— Communicating Concrete, Radio Frequency harvesting, Wireless Sensor Networks, Energy Efficiency.

I. Introduction

THE early 21st century witnessed the emergence of various technologies associated with the Internet of Things (IoT), such as Wireless Sensor Networks (WSN), Radio-Frequency IDentification (RFID), and Near-Field Communication (NFC). The rapid advancement of these technologies led to their widespread adoption in diverse research domains, including manufacturing, where Internet of Things (IoT) forms the foundation of the intelligent product paradigm [1]. In this vision, manufactured goods can collaborate to transmit information and respond to events throughout their life cycle, a concept extensively employed in industry [2]. In 2009, the concept of "communicating materials" was initiated [3]. It envisages materials possess the ability to communicate with their environment, process, exchange information, and store

This paper was first submitted in May 2023.

The project described in this article has received funding from the French National Agency of Research (ANR) under grant agreement no ANR-17-CE10-0014-03.

M. David and W. Derigent are with the CRAN laboratory, CNRS UMR Université de Lorraine, 54500 Vandoeuvre-lès-Nancy, FRANCE (e-mail: firstname.lastname@univ-lorraine.fr)

G. Loubet, A. Takacs and D. Dragomirescu are with the LAAS-CNRS, Université de Toulouse, CNRS, UPS, INSA; 7, Avenue du Colonel Roche, 31400 Toulouse, France (e-mail: name@laas.fr)

data within their own structure. Additionally, they can sense their surroundings and measure their internal physical states, retaining these properties even after various transformations (e.g., drilling, milling, cutting) or assembly (in fact, the resulting assembly also qualifies as a communicating material). This concept has found application in diverse sectors, including textiles, wood [3], and construction, as elaborated later. As emphasized in [4], communicating materials offer a range of compelling attributes:

(a) They can convey valuable information concerning design, manufacturing, and logistics, which proves beneficial during the Beginning of Life stages (design, manufacturing, and construction) as well as the End-of-Life phases (dismantlement and recycling) of a building.

(b) Given their ability to sense the environment and process relevant data, they can also function as sensors during the Middle of Life stages (exploitation and maintenance) for monitoring purposes and issue notifications.

This continuous monitoring capability throughout a product's life cycle has led to the concept of "Product Lifecycle Monitoring," as depicted in Fig. 1. A multitude of technologies, spanning from chemical products [3] to Internet of Things solutions, can be harnessed to develop communicating materials, making this concept applicable to a wide array of sectors.

Section II presents the context and challenges that arise when designing a communicating material, for the construction industry. It describes the cyber-physical architecture proposed to implement the concept of communicating concrete. Main scientific contributions and research results about the embedded WSN and its energy problematic are exposed in Section III. A discussion is proposed Section IV. Section V is then dedicated to some conclusions and perspectives.

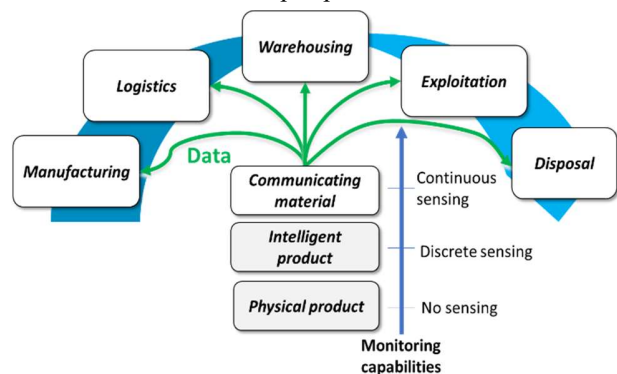

Fig. 1. Product Lifecycle Monitoring .

II. CONTEXT AND CHALLENGES WHEN DESIGNING COMMUNICATING CONCRETE

A. Construction and Structure Health Monitoring Needs

Concrete's versatility, durability, and cost-effectiveness have established it as the world's primary construction material. To optimize cost and time considerations, the utilization of precast concrete is steadily increasing. For instance, in the United States alone, approximately 260 million cubic meters of precast concrete are used annually, amounting to over \$15 billion [5].

An interesting feature of precast concrete is its ability to incorporate embedded electronics to introduce new functionalities. Various research initiatives have underscored the advantages of integrating Internet of Things technologies into precast products. In-depth investigations in the construction field have highlighted the potential economic benefits at all phases of the precast concrete lifecycle, as outlined in [6]. This includes enhancements in precast quality management [7] and in the construction supply chain [8], accomplished by providing stakeholders with product-related information. Moreover, Wireless Sensor Networks find applications in scenarios requiring active monitoring, such as in manufacturing or Structural Health Monitoring (SHM) [9]. In this context, exploring the use of Wireless Sensor Networks is interesting because wireless Structural Health Monitoring solutions can be used to easily equip large buildings that have already been built, e.g. a nuclear power plant.

B. Proposed Cyber-Physical Architecture

Fig. 2 illustrates the design of a "communicating concrete", which is a concrete element equipped with an embedded Wireless Sensor Network (physical world) and able to communicate with other information systems, as Building Information Modeling (BIM) platforms (digital world). Building Information Modeling platforms have been taken as a target since they are widely used in the construction industry.

Our aim is to define a cyber-physical architecture in the sense of [10], linking the physical world to the digital one. To build this specific architecture, many works are based on the Holon concept, introduced by [11]. The world "Holon" is a combination of the Greek "Holos" {whole} with the suffix "-on" (which suggests a part). The Holon is a central concept of

our proposed architecture since it is considered as a modelling construct. Each communicating concrete is a Material Holon (MH), composed of a physical part, in which the Wireless Sensor Network is embedded, and a digital part composed of a database coupled with an agent. As an example, the Fig. 2 represents two low-level Material Holons: MH1 and MH2. The physical part of MH1 is equipped with a Wireless Sensor Network composed of Communicating Nodes CN1, CN2, and Sensing Nodes SN1 to SN4. Both physical parts are linked to agents representing the intelligence of the Holons, and to a common database in which information related to all Material Holons is gathered. Agents are designed to monitor the system from two perspectives:

Asset management: Agents monitor their related physical part, by executing expert rules. If an event occurs (e.g. the state of the physical part changes), a notification is then sent towards the Building Information Modeling platform. This monitoring process only concerns the physical part, the concrete itself.

Energy consumption: As the whole system is ought to have the longest possible lifetime, the Wireless Sensor Network itself is monitored. In case of problem (e.g. dying node, differences in energy consumption, etc.), the agent notifies user and can also propose solutions to reconfigure the network.

Material Holons can be grouped with other Material Holons to form higher-level Material Holons. In Fig. 2, MH3 is a higher-level Holon, created thanks to the composition of MH1 and MH2. In the physical world, both former Wireless Sensor Networks are merged (creation of a link between CN1 and CN3). In other words, several communicating concretes could be grouped to form a bigger one, which should act as a single communicating concrete. In the digital world, a new agent (MH3 agent) is created, composed of MH1 and MH2 agents. Moreover, the higher-level agent has a global vision of all the embedded network, which is better to monitor and reconfigure the network itself. Moreover, merging Wireless Sensor Networks in the physical world could lead to reductions in energy consumption, since it would reduce the number of nodes using a long-range interface.

The Wireless Sensor Network architecture is composed of two types of nodes: the Sensing Nodes (SN) and the Communicating Nodes (CN). Sensing Nodes measure parameters (temperature, humidity, and dielectric resistivity (to

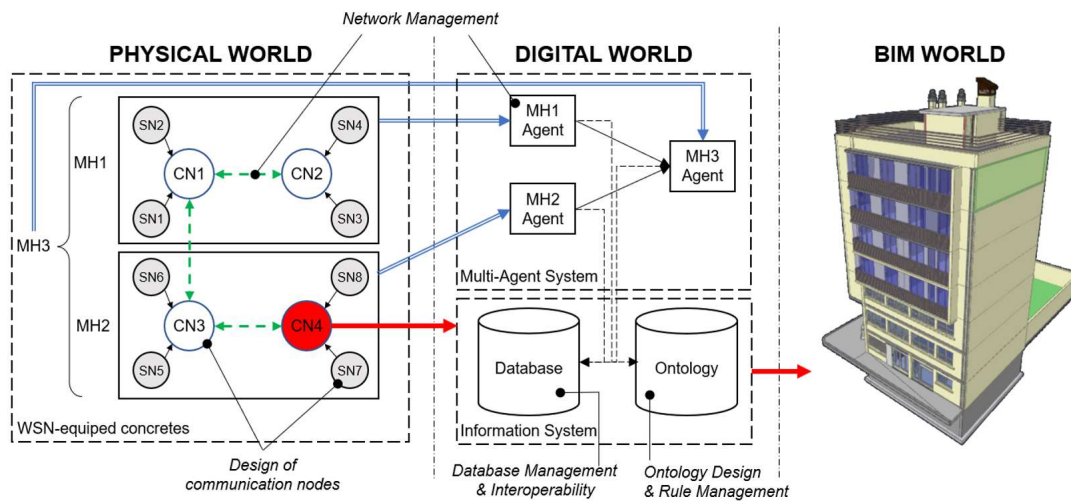

Fig. 2. Physical and digital architectures of a communicating concrete.

estimate the corrosion rate) are the main interesting parameters designated by experts) and transmit measured data to a Communicating Node(s). The Communicating Nodes then process, exchange and transfer the received data to the digital worlds and its models. Because the idea is to cover the whole concrete lifecycle, an energy-efficient network is required. As a result, Sensing Nodes are designed as low energy and battery-free sensors powered via Wireless Power Transfer (WPT), coming from the Communicating Nodes. These last ones form the inner network of a communicating concrete. They also are energy-efficient nodes, equipped with two different communicating interfaces. A near-range interface is used for inter-Communicating Nodes communication. A long-range interface is used to send information to the digital world via the Internet. Thanks to embedded Wireless Sensor Network, concretes can monitor, process and send product-related information (like temperature, humidity, estimated corrosion rate and so on) which is required all along the concrete lifecycle. Once gathered, information can be directly accessed from Building Information Modeling platforms or used by the agents to notify the physical states to Building Information Modeling platforms.

C. Challenges towards communicating material

The concept of communicating material, while promising, presents several intricate challenges:

Material integration is a key concern, demanding both technical expertise and a profound grasp of material science to seamlessly embed the technology within structural components. Sensory integration, vital for data collection, must also be achieved without compromising material integrity. Sustainability is paramount, necessitating exploration of eco-friendly alternatives and production processes.

Data security within the digital realm poses challenges, requiring robust encryption and protection mechanisms to safeguard sensitive information. Harnessing vast data generated by these materials calls for advanced analytics and processing capabilities to derive meaningful insights.

Durability is crucial, especially for long-lasting infrastructures. Maintaining uniform energy efficiency across the system is complex but essential for maximizing the benefits of communicating materials while ensuring stability. Ensuring homogeneity of energy consumption and communication between nodes is crucial for maintaining system stability. Any imbalance can lead to inefficiencies and potential failures within the network.

In summary, the communicating material challenges encompass diverse domains, from material science to cybersecurity, energy efficiency, and sustainability. Addressing these issues is vital to unlock its potential. The following sections focus on the physical part of the cyber-physical architecture and delves into the energy efficiency challenge for sensing or communicating concrete.

III. PUSHING THE LIMITS OF COMMUNICATING CONCRETE'S LIFETIME

A. The Energy Issue

Communicating concrete systems must remain operational for extended periods, often spanning several decades. The swift

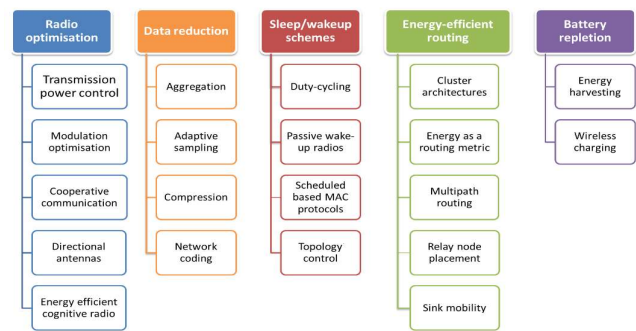

Fig. 3. Classification of WSN energy efficient mechanisms [14].

advancements in microprocessors and sensors have led to the widespread adoption of Wireless Sensor Networks across diverse domains, including environmental monitoring [12], building surveillance [13], and logistics. In communicating material applications, where replacing batteries can be particularly challenging, assessing the longevity of a Wireless Sensor Networks requires a detailed examination of the energy consumption of its constituent components:

- *Sensor(s)* measures physical phenomena (humidity, temperature and dielectric resistivity) in concrete, and converts it into digital data and transfers to the processor.

- *Central Process Unit* is the core part of the node. Thanks to memory and processing capabilities, monitored data can be stored, filtered, or transmitted to other nodes.

- *Communication Unit* receives and transmits data from and to other nodes. Sensing Nodes have a single communication interface while the Communicating Nodes have two.

Indeed, node energy consumption can be summarized by these three aspects. Among them, communication generally consumes more energy than the other components. As described in [14] and in Fig. 3, there are five energy efficient kind of strategies to extend Wireless Sensor Network lifetime: radio optimization, data reduction, sleep/wakeup schemes, energy-efficient routing, and battery repletion.

Over the last decades, some research focus on reducing the energy cost of radio, such as adaptive power control [15], or energy efficient radio [16]. Simultaneously, a considerable amount of research is dedicated to enhancing communication efficiency at nodes [17]. In pursuit of this goal, certain approaches, such as in-network processing techniques, aim to reduce the volume of generated messages, as demonstrated in [18]. Furthermore, there are endeavors concentrated on addressing resource limitations by focusing on power supply, exemplified by the energy harvesting techniques introduced in [19,20]. In this work, energy optimization is studied and developed in two ways (or levels) to improve the network lifetime of our proposed cyber-physical architecture:

- *Sensing Nodes energy optimization*: using an efficient hardware design and Wireless Power Transfer, corresponding on radio optimization and battery repletion in Fig. 3. This original system and experimental results are described in section III.B.

- *Energy conservation for the network of Communicating Nodes*: using data reduction, sleep/wakeup scheme and energy-efficient routing techniques, as shown in Fig. 3. An energy efficient gathering strategy and related analytical consumption

models were designed to minimize and quantify the energy usage of the Communicating Nodes network, as described in Section III.C.

B. Optimizing the Energy for the Sensing Node

A low-power Sensing Node capable of harvesting energy is exposed in the following. The section 1 details its design while section 2 presents our experimental results.

1) Sensing Node Design

The Sensing Nodes are intended to be fully buried in the reinforced concrete as these must measure and communicate data related to its internal state. Thus, a Sensing Node becomes inaccessible and must meet three main requirements.

- make relevant and low-power measurements from the core of the reinforced concrete;
- transmit wirelessly and reliably the collected data from the reinforced concrete, a highly constraining propagation medium for the electromagnetic waves [21];
- be battery-free and energy autonomous for long-term deployment, whatever the environment of deployment.

The architecture of the designed and implemented Sensing Nodes is presented in Fig. 4.

For the wireless communications from Sensing Nodes to Communicating Node(s) through reinforced concrete and/or air, electromagnetic technologies have been preferred to those based on light or mechanical waves, which are not commercially available and cannot be efficiently propagated over medium ranges through all kind of medium. After initial tests of indoor communications, LoRaWAN has been chosen as providing the longest ranges without losses (more than a few hundreds of meters, with the ability to pass through a lot of reinforced concrete elements), despite a power consumption considered "low" (approximately 100 mW at 3.3 V in active mode and with +14 dBm transmissions) but much higher than other technologies, such as Bluetooth Low Energy (BLE) (providing a range of use of tens of meters with the ability to pass through only few reinforced concrete elements for a power consumption of approximately 25 mW at 3.3 V in active mode and with +3 dBm transmissions). To reduce power consumption, the data downlink (from Communicating Node(s) to Sensing Nodes) has not been implemented, neither for pairing or acknowledgement. Thus, energy is saved by deleting the listening time and security is increased by closing backdoors with fixed firmware and no access to alter it.

Energy autonomy has been considered with regards to the energy needs for measurement, processing, and transmission. To overcome the limitations of battery, some works focus on alternatives to the power supply of Sensing Nodes, such as

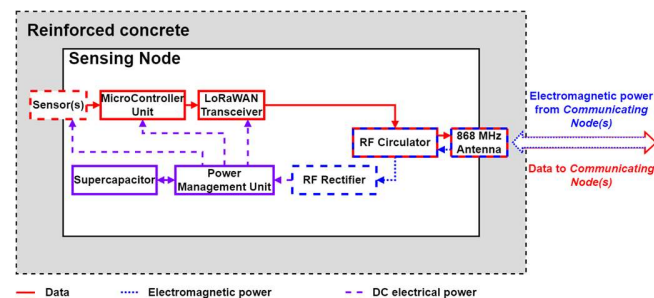

Fig. 4. Block diagram of the architecture of the Sensing Node.

energy harvesting and Wireless Power Transfer (WPT) [22]. Ambient energy harvesting solutions are based on the scavenging of residual energy (light, mechanical, thermal, electromagnetic) from fluctuating, unpredictable and uncontrollable sources. To be independent of the deployment environment, Wireless Power Transfer is preferred over ambient energy harvesting because based on dedicated power sources. Regarding the electromagnetic Wireless Power Transfer, several technologies coexist: in near-field (capacitive, non-resonant, and resonant inductive) and in far-field (radiative). To achieve sufficient range of use (at least ten of

meters), far-field solutions are preferred. These provide various performances usually dependent of the chosen frequency band, which is subject to regional regulations in terms of maximum Equivalent Isotropic Radiated Power (EIRP) [23]. The free space path losses are a function of the frequency: the higher the frequency, the larger the free-space losses, and the shorter the range of use. Also, it must be noted that the overall size of the Sensing Node is correlated to the size of their antenna(s), which is closely related to their frequency: the higher the frequency, the smaller the antenna. The ISM 868 MHz frequency band offers the best trade-off between Sensing Nodes size and range of use, with the possibility to transmit up to +33 dBm (or 2 W) EIRP, as justified in [19]. Also, a supercapacitor is used as energy buffer to provide battery-free Sensing Nodes, as well as a Power Management Unit (PMU) which is able to cold-start and to work with a low input power.

By considering both wireless communication and radiative Wireless Power Transfer, the proposed Wireless Sensor Network meets the paradigm of Simultaneous Wireless Information and Power Transfer (SWIPT) [24]. A unique antenna is used simultaneously for the two functions with a RF circulator (low insertion losses, high isolation). To make this antenna properly work once buried into the reinforced concrete thus in a direct contact with it, the impedance mismatch must be avoided. Its design must be adapted by considering the reinforced concrete as the main propagation medium (thus, by considering its dielectric properties which change during time) [25].

The number of Sensing Nodes will be a function of the size of the element and the targeted spatial accuracy considering the tolerance in terms of nodes that may not/no longer work. The aim is to propose Sensing Nodes with the same volume as the largest aggregates permitted in the concrete recipe. In this way, the mechanical properties could be certified by the manufacturer.

2) Experimental Test and Results

Our works focused on the implementation and optimization of the Sensing Nodes, and its components: rectenna design and optimization, Power Management Unit choice and optimization, supercapacitor choice, etc. These works resulted in the Sensing Node prototype described in Fig. 5.a, and fully presented in [19]. A printed folded quart-wavelength dipole antenna with capacitive arms has been designed and optimized [26]. Powered by Wireless Power Transfer, the Sensing Nodes are battery-free and able to cold-start from a minimum power of -17 dBm at the input of the rectifier. As the input

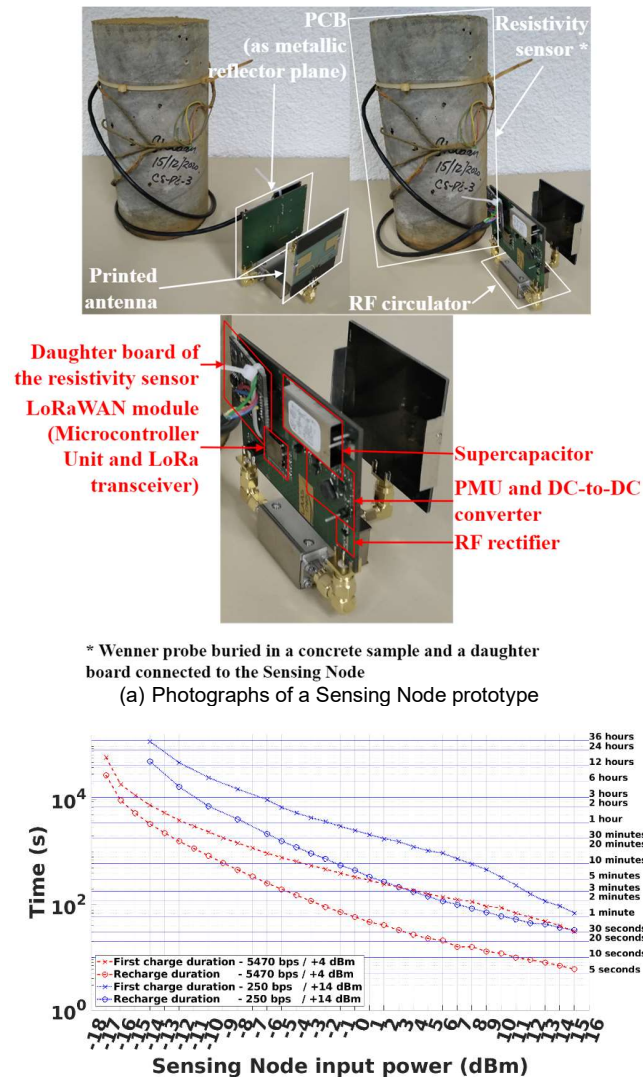

(b) Durations of the first charge ('x') and recharges ('o') against the conducted electromagnetic input power applied at the input of the rectifier of the Sensing Nodes, for a frequency of 868 MHz, and for two configurations of the wireless communication: transmission power of +4 dBm and data-rate of 5470 bps (dashed lines), and transmission power of +14 dBm and data-rate of 250 bps (dotted lines).

Fig. 5. Implementation of the Sensing Node.

electromagnetic power is much lower than the DC power required by the active Sensing Node elements, a "store then use" strategy is used. Thus, 21 mJ of energy is stored in a 2.2 mF supercapacitor to run a full process, composed of sensing, data formatting, and transmission of a 17 bytes LoRaWAN frame with 4 bytes of payload. This represents 5.25 mJ per data byte, 309 mJ per transmitted byte, or 39 μ J per transmitted bit, in the more energy efficient configuration, id est the lowest RF output power (+4 dBm) and the highest data-rate (5470 bps), thus the shortest time of transmission. This amount of energy is a +20 % overestimate of the average needs, to compensate for variability and aging of components. The communication can

be more reliable with a higher RF output power (up to +14 dBm) and/or a shorter data-rate (down to 250 bps) as the price of a higher power consumption.

Also, the periodicity of functioning is a function of the

electromagnetic input power, as characterized in Fig. 5.b. For a first charge (from an empty 2.2 mF supercapacitor), about 17 h 21 min are required for a full process with an input power of -17 dBm, compared to about 30 s at +15 dBm. For a recharge, about 7 h and 59 min are needed at -17 dBm, compared to about 6 s at +15 dBm. Obviously, longer periodicities can be achieved by Communicating Nodes by adjusting the behavior of their power sources. By applying the Friis equation, and considering the antenna gain of +1.54 dBi and the +33 dBm EIRP continuous wave at 868 MHz created by a power source, it is possible to estimate the maximum range of use in line of sight and for a specific input power. Thus, -17 dBm can be harvested at 10.38 m, and -10.6 dBm (i.e. for a first charge of about 46 min and 40 s, and recharges of about 17 min) can be harvested at 5 m. By adding an 8 cm x 6 cm metallic reflector plane behind the antenna, its gain is increased to +5.00 dBi, and -17 dBm can be harvested at 13.78 m, and -7.2 dBm (i.e. for a first charge of about 20 min and 50 s, and recharges of about 6 min and 9 s) can be harvested at 5 m. By minimizing the required input power, this distance can be increased, while for the same distance, the charging time can be reduced. This last can also be reduced by minimizing the amount of energy to store. Also, the range of use is limited by WPT regulations and not by wireless communication [23].

Qualitative tests have been performed to certify the proper functioning of the system in realistic configuration (*id est* similar to real cases). Especially, as shown in Fig. 6, a Cyber-Physical System composed of a meshed network of 2 Communicating Nodes and 4 Sensing Nodes (3 embedded in air cavities specifically designed in a reinforced concrete beam) and with a minimum distance of 3 meters between the main Communicating Node and the Sensing Nodes (with at least 15 cm of reinforced concrete, with rebars) has been successfully tested for temperature, relative humidity and electrical resistivity measurements. This Communicating Node powers and controls all the Sensing Nodes in its neighborhood wirelessly and omnidirectionally over meters and collects without losses all the data sent by all the Sensing Nodes. It then processes, stores and shares this data with another Communicating Node and distributed Building Information Modeling platforms via the Internet. The employed reinforced (by metallic rebars) concrete beam has been provided by an industrial partner and meet the structural specifications defined by the manufacturer (especially in terms of mechanical properties). This is a typical case studied without knowing its characteristics in order to propose a generic solution. It must be noted that reinforced concretes are highly inhomogeneous



Fig. 6. Photographs of an experimental set-up of Sensing Nodes embedded in a reinforced concrete beam.

materials for which there are no simple models and is a harsh environment for electromagnetic waves propagation.

Among the results obtained, some have, to our best knowledges, made it possible to reach the state of the art. (a) Generic Sensing Nodes, fully wireless, low-power, battery-free, wirelessly powered and controlled, and part of a full Cyber-Physical System that can automate monitoring, are proposed. For the first time, an embedded resistivitymeter has been provided. It measures the dielectric resistivity is the core of the concrete, as presented in Fig. 5.a with a concrete sample in which the probes are buried, and its evolution over time allows to estimate the corrosion rate. (b) An indoor distance of 11 meters between Communicating Node and Sensing Nodes has successfully been reached. This is the largest distance achieved for Wireless Power Transfer in low-power Internet of Things applications complying with regional regulations. It even seems possible to achieve wider ranges. (c) -17 dBm is the lowest electromagnetic input power required by the Sensing Nodes to work properly. This minimum input power is a function of the rectifier efficiency, the power required by the Power Management Unit, and the power losses of the circulator and supercapacitor. Only e-peas AEM30940 PMU seems to be able to work from -18.5 dBm in the ISM 868 MHz band [27]. (d) The Wireless Power Transfer system allows to reconfigure wirelessly and remotely the frequency of functioning of the buried Sensing Nodes, with power downlink and without physical access or data downlink. The Communicating Nodes can tune their radiative power source in terms of waveform, output power and/or duty cycle. (e) For the first time, a unique antenna is used simultaneously for data communication and energy harvesting, offering a new way to address the SWIPT paradigm.

Table I. compares commercially available and published Sensing Nodes. Commercial solutions: (1) are powered by (primary or secondary) battery, thus, have a lifetime limited to a few years; (2) use generally a wireless datalogger manually placed on the concrete, and wired and sacrificed sensor(s) non-necessary buried; (3) employ a wide variety of wireless communication technologies for ranges between a few and hundreds of meters; and (4) employ a wide variety of sensors. Regarding the academic researches, some: (1) provide battery-free Sensing Nodes wirelessly powered over a few meters by radiative Wireless Power Transfer or by ambient energy harvesting; (2) employ Low Power Wide Area Networks or Wireless Personal Area Network wireless communication technologies for ranges between a few and hundreds of meters; (3) employed conventional sensors; and (4) answer the Simultaneous Wireless Information and Power Transfer paradigm, thanks to frequency and/or spatial multiplexing.

C. Energy for the Network of Communicating Nodes

As underlined in section III.A, this section addresses the problem of the energy conservation for the network of Communicating Nodes, responsible for routing the data from the Sensing Nodes to the root Communicating Node, and then to Building Information Modeling platforms. To tackle this problem, our first objective is to evaluate energy cost related to different strategies of data collection. As a result, this section develops energy consumption models for Wireless Sensor

Network. In this work, as the concrete bars are straight elements, the models are adapted for a Communicating Node chain network structure. Lessons learned from concrete manufacturer specialists showed that propagation characteristics depend on every kind of concrete (there are several concrete families and thousands of concrete recipes). Moreover, for a concrete recipe, the homogeneity of the environment is not guaranteed. Distance estimation between nodes, in addition to being an energy-intensive activity, is also randomized by the heterogeneous environment. In literature, classical "radio dissipation" models, which is based on the distance between transmitter and receiver, have been intensively used to estimate the energy spent by Wireless Sensor Network. This kind of model may not always be practical for real-world energy consumption or network-wide energy assessment. Therefore, a simple, analytical, and effective energy consumption model is needed for quickly and accurately estimating the lifetime of each Communicating Node. This can be used for selecting appropriate protocols and/or technologies for different applications, as well as for online self-assessment by individual Communicating Node of their consumed energy. The development and use of such a model are described below.

1) Estimating Data Collection Network Energy Consumption

The communicating concrete lifetime need to be precisely assessed and so on, its energy consumption too. For that purpose, a generic (technology independent) and integrated approach is proposed to limit and predict energy consumptions. Analytical and practical consumption models are exposed and validated by experimentation in [4]. A simple Sender-Receiver synchronization method is used during collection process to optimize the radio activity duration of each node. Collection process can be realized with or without data aggregation and is illustrated in Fig. 7. The symbols used are defined in Table II.

While gathering data, a significant portion of energy consumption is attributed to communication. In the context of concrete applications, it's not feasible to employ an energy model based solely on distance.

TABLE II
SUMMARY OF SYMBOLS

Symbols	Unit	Definition
E_i	Energy (Joule)	Energy consumption of node i
P_{active}	Power (Watt)	Power of active state
P_{sleep}	Power (Watt)	Power of sleep state
$D_{active}(i)$	Time (second)	Active duration of node i
$D_{sleep}(i)$	Time (second)	Sleep duration of node i
α	Time (second)	Transmission duration
β	Time (second)	Inter Frame Space time
γ	Time (second)	Time for ACK message
d_{syn}	Time (second)	Wake up duration
T	Time (second)	Data collection period
N	Number	Chain size (Number of nodes)

TABLE I
COMPARISON OF COMMERCIAL AND ACADEMIC SENSING NODES DEDICATED TO THE STRUCTURAL HEALTH MONITORING OF REINFORCED CONCRETE, AND ACADEMIC SOLUTIONS FOR THE WIRELESS POWER TRANSFER OF WIRELESS SENSOR NETWORKS

	Ref.	Manufacturer or publication date	Wireless communication technology (frequency)	Deployment strategy (impacting on ease of implementation)	Available sensor(s)	Power source	Estimated lifetime
Industrial solutions	[28]	Doka	Cellular (2G, 3G, 4G); BLE (2.45 GHz)	Node on concrete surface and sacrificed sensor in concrete	Temperature*	Battery	3 months
	[29]	Concrefy	LoRa (868 MHz)	Node on concrete surface	Temperature*; pressure	Battery	N/A
	[30]	360 SmartConnect	NFC (13.56 MHz)	Tag a few centimetres in concrete	N/A	Backscattering	Very long
	[31]	idencia	RFID (13.56 MHz)	Tag on concrete surface	N/A	Backscattering	Very long
	[32]	CAPTAE	Cellular (3G, 4G); RFID (13.56 MHz)	Node on concrete surface	Temperature*; humidity; strength/constraints; elastic and inelastic deformations; inclination; pressure; displacement; defects and shock detection; weather parameters; almost any type of sensor on request	Battery	Between 1 and 3 years
	[33]	TELEMAC	Cellular (3G)	Wireless datalogger on concrete surface with 5 wired sacrificed sensors in concrete	Temperature*; humidity; strength/constraints; elastic and inelastic deformations; inclination; load/pressure; displacement; defects and shock detection	Battery	Between 5 and 10 years
	[34]	CEMENTYS	LoRa (868 MHz)	Wireless datalogger on concrete surface with 8 wired sacrificed sensors in concrete	Temperature*; humidity; strength/constraints; elastic and inelastic deformations; inclination; load/pressure; resistivity for corrosion estimation	Battery	N/A
	[35]	itmsol	Cellular (2G, 3G); BLE (2.45GHz); LoRaWAN (868 MHz); SigFox (868 MHz); NB-IoT; LTE-M; other solutions on request	Wireless datalogger on concrete surface with up to 5 wired sacrificed sensors in concrete	Temperature*; humidity; strength/constraints; elastic and inelastic deformations; inclination; load/pressure; defects and shock detection	Battery	Between 7 months to 6.4 years
	[36]	WAKE	Cellular; RFID (13.56 MHz); BLE (2.45 GHz)	Wireless datalogger on concrete surface with up to 24 wired sacrificed sensors in concrete	Temperature*	Battery	Between 4 months and 3 years
	[37]	GIATEC	Cellular; Wi-Fi (2.45 GHz); BLE (2.45 GHz)	Node in concrete	Temperature*; strength/constraints	Battery	Up to 4 months
	[38]	LumiCON	Cellular	Node in concrete	Temperature*; strength/constraints	Battery	N/A
	[39]	HILTI	BLE (2.45 GHz); undefined LPWAN	Node in concrete	Temperature*; strength/constraints	Battery	2 months
	[40]	Maturix	NFC (13.56 MHz); RFID (13.56 MHz); SigFox (868 MHz)	Node on concrete surface and sacrificed sensor in concrete	Temperature*; humidity; strength/constraints	Battery	N/A
	[41]	GreenWake Technologies	Non-standardised (868 MHz)	Node on concrete surface	Temperature*; humidity; pressure; acceleration/inclination; magnetic field; luminosity; mechanical deformation	Radiative WPT (from +27 dBm to +36 dBm at 2.45 GHz) for battery-free node with 200 μ F tunable capacitor (specified for input powers between -9 dBm and +15 dBm)	Very long
Academic solutions	[42]	2009	Non-standardised (2.45 GHz)	Node on concrete surface	Temperature*; humidity; deformations; luminosity; acceleration	Battery	Months
	[43]	2011	Non-standardised (433 MHz)	Node in concrete	Temperature*; humidity; impedance	Battery	N/A
	[44]	2012	ZigBee (868 MHz)	Node in concrete	Temperature; humidity; electromechanical impedance	Battery	Nearly one month
	[45]	2016	LoRa (868 MHz)	Node on concrete surface	Temperature*; humidity; car traffic (indirectly)	Mechanical energy harvesting (vibrations) for battery-free node	Long
	[46]	2017	Non-standardised (169 MHz)	Node in concrete	Temperature*; strength/constraints	Inductive WPT (100 kHz) to recharge battery	Months
	[47]	2018	LoRaWAN (868 MHz)	Node on concrete surface	Temperature*	Radiative WPT (845 MHz) for battery-free node	Very long
	[48]	2018	LoRaWAN (868 MHz)	Node on concrete surface	Crackmeter	Solar energy harvesting to recharge battery	10 years
	[49]	2019	LoRaWAN (868 MHz)	Node on concrete surface	Temperature*; humidity; pressure; displacement; acceleration/inclination; magnetic field	Solar energy harvesting to recharge battery	N/A
	[50]	2020	Wired (N/A)	Sensor in concrete and pseudo-node on concrete surface	Resistivity for corrosion estimation	External (laptop via USB)	N/A
	WSN powered by WPT	[51]	2009	ZigBee (2.45 GHz)	Node on concrete surface	Impedance	Radiative WPT (+30 dBm at 2.45 GHz) for battery-free node located at 1 meter with 100 μ F capacitor
[52]		2021	LoRa (2.45 GHz)	N/A	Acceleration	Radiative WPT (2 · +27 dBm at 2.45 GHz) for battery-free node located up to 0.54 meter with 2.47 mF capacitor	Very long
[53]		2017	DASH7 (868 MHz)	N/A	Temperature* and relative humidity	Radiative WPT (+27 dBm or +33 dBm at 868 MHz) for battery-free node located up to 8.4 meters with 8 mF supercapacitor (tested for input powers from -17 dBm)	Very long
[54]		2018	BLE (2.45 GHz)	N/A	Temperature*; pressure; acceleration	Radiative WPT (+27 dBm dBm at 868 MHz) for battery-free node located up to 2 meters with 1 mF supercapacitor (tested for input powers from -10.5 dBm)	Very long
[55]		2019	BLE (2.45 GHz)	N/A	Temperature* and relative humidity; acceleration	Radiative WPT (+34.6 dBm at 868 MHz) for battery-free node located up to 1.5 meters with capacitor (tested for	Very long

					input powers between -10 dBm and +5 dBm)
This work [19]	Since 2018	LoRaWAN (868 MHz)	Node in concrete	Temperature*; humidity; deformations; resistivity for corrosion estimation	Radiative WPT (+33 dBm at 868 MHz) for battery-free node located up to 11 meters with 2.2 mF supercapacitor (tested for input powers between -17 dBm and +15 dBm at the output of the antenna)
					Very long

* Temperature measurements (that can be combined with humidity and/or strength measurements) are usually used during the curing phase in order to monitor the concrete maturity.

N.B.: Cost information for each Sensing Node is not available.

Consequently, a time-based energy model is employed, which accounts for four distinct states of the radio communication module:

- *Transmit (Tx)*: transmitting message to other Communicating Nodes;
- *Receive (Rx)*: receiving message from other Communicating Nodes;
- *Idle*: active but not receiving or transmitting data;
- *Sleep*: inactive with a low energy cost.

Each state involves a different level of energy consumption, but Tx, Rx and Idle states are generally close. Transition delays between states depend on the radio module device and its host microcontroller. Transition costs have been studied by some researchers [56]. Compared with active duration for transmission and data processing, transition delays are neglectable, and they are thus ignored. Therefore, to give an approximate node lifetime, our model only considers the active and inactive (sleep) states of radio modules.

The energy consumption of radio module can be simplified in (1) with the active and sleep states:

$$E = (E_{Tx} + E_{Rx} + E_{Idle}) + E_{Sleep} = P_{active}D_{active} + P_{sleep}D_{sleep} \quad (1)$$

where P_{active} is the mean power of the three mentioned active states (*Tx*, *Rx*, *Idle*); P_{sleep} is the power expended in sleep state. D_{active} and D_{sleep} are its time intervals, respectively. To estimate energy cost of data collection in each round, it is necessary to compute the intervals of each state.

Energy consumption for a node i in N-node chain structure can be estimated as:

$$E_i = D_{active}(i) * P_{active} + D_{sleep}(i) * P_{sleep} \quad (2)$$

Considering T as the period between two cycles of data collection, for each cycle:

$$D_{sleep}(i) = T - D_{active}(i) \quad (3)$$

So, energy consumption of node i during a data collection cycle can be expressed in (4):

$$E_i = D_{active}(i) * P_{active} + (T - D_{active}(i)) * P_{sleep} \\ E_i = D_{active}(i) * (P_{active} - P_{sleep}) + T * P_{sleep} \quad (4)$$

To determine the activity duration $D_{active}(i)$ of each node, all the delays involving radio activity during the collection process are considered, as taken into account in Fig. 7. During a collection cycle, the communication activity of a node can be decomposed in 3 phases: 1. Retrieving Data from previous nodes, 2. Acknowledgment of previous node, 3. Transmission of Data to next node. Whatever the collection process, a duration-based energy consumption model can be expressed with these parameters: transmission delay of a *data* message Tx (α), duration of Inter Frame Space (β), transmission delay of an *ack* message (γ) and a wake-up delay (d_{syn}).

For illustrating different data collection strategies in a Communicating Nodes-chain and for exploring energy consumption profiles, activity duration models for each Communicating Node were developed in two cases: collection with or without data aggregation. In the following examples, ack and data messages are supposed to have the same size and so the same duration. A collection protocol minimizing the delays is employed as in [4].

Without data aggregation, the minimum active duration of node i in a N-node ($N \geq 3$) chain structure can be stated as:

$$D_{active}(i) = \begin{cases} 3\alpha + 3\beta, & \text{when } i = 1 \\ (i-1) * 2 * (\alpha + \beta) + 4\alpha + 3\beta + d_{syn}, & \text{when } 2 \leq i \leq n-1 \\ (i-1) * 2 * (\alpha + \beta) + 3\alpha + 2\beta + d_{syn}, & \text{when } i = n \end{cases}$$

For a chain collection with data aggregation: the minimum radio activity duration of node i can be expressed as:

$$D_{active}(i) = \begin{cases} 2\alpha + 2\beta, & \text{when } i = 1 \\ 4\alpha + 3\beta + d_{syn}, & \text{when } i \neq 1 \end{cases}$$

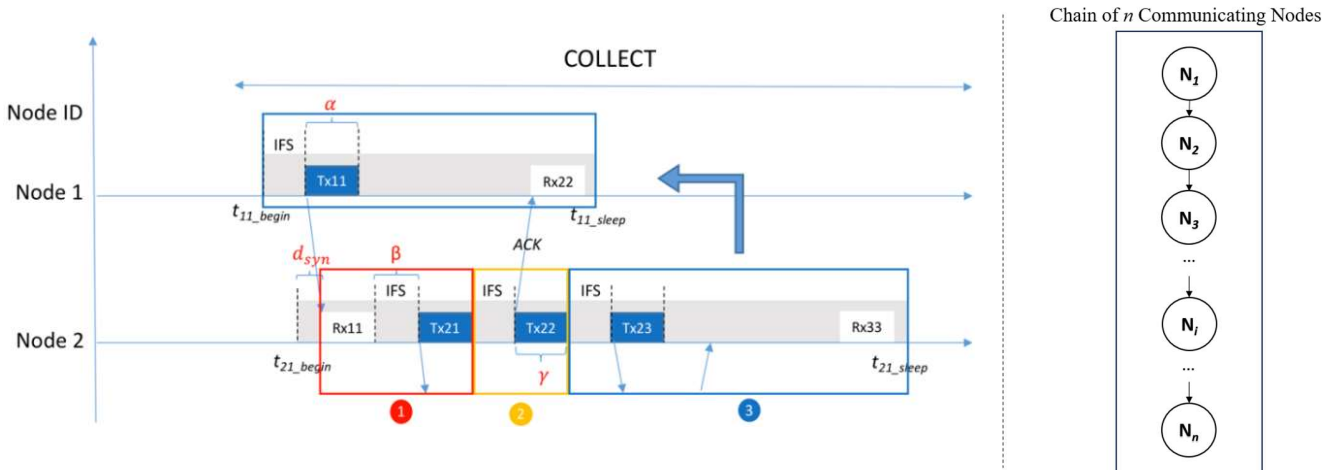

Fig. 7. One cycle data collection for a chain network of Communicating Nodes.

The model without data aggregation reveals the hotspot problem because the radio activity increases with the rank of the node in a chain. On the contrary, apart from a slight difference for the first node, data aggregation shows constant activity duration throughout the chain. These kinds of models will be analysed in the next section.

2) Analysis on Energy Consumption Models

Classical random duty-cycle approaches are not adapted for an embedded Wireless Sensor Network in material. Synchronization between nodes is necessary to efficiently moderate radio activity. A simple Sender-Receiver synchronization mechanism, which can be easily adapted to every wireless technology using TDMA-based (Time Division Multiple Access) MAC (Medium Access Control) protocols, must be used to avoid collision and to wake-up radio interfaces as less as possible. For construction application, Wireless Sensor Network is supposed to capture physical parameters (humidity, temperature or dielectric resistivity to estimate corrosion rate) with very slow evolution. The value of the duty-cycle drastically decreases if data are collected every hour.

With the models, energy predictions can be made. The size of chain (N), the respective powers of radio module (P_s , for sleep state and P_a , for active state) and data collection period (T) can be determined for all the lifetime of a concrete piece. Without data aggregation, activity duration rises linearly with the position of node in a chain, revealing and quantifying the hotspot problem. Using data aggregation reduces and uniformizes the activity duration of each node. The energy consumption is consequently homogeneous all along the network. These analytical energy models were compared with a real platform, and a forecast accuracy of 95 % was demonstrated [4]. The energy consumption of a node's radio interface relies on just five parameters when data aggregation is employed, resulting in uniform consumption throughout the chain. However, in scenarios involving data collection without aggregation, the energy expenditure also varies with the node's position in the chain. The overall expression for the energy consumed by a node is formulated as follows:

$$E_{consumed} = f(\alpha, \beta, \gamma, P_s, P_a)$$

Fig. 8 gives a representation of the model for a node transmitting data during one collection cycle. P_s gives the consumption tendency between two collection periods. P_a gives the tendency during activity. The duration of radio activity depends on (α, β, γ) . The model parameters can be adapted for

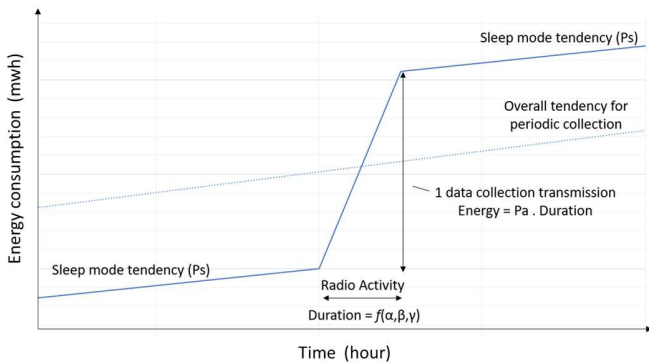

Fig. 8. Radio energy consumption Model for a Communicating Node.

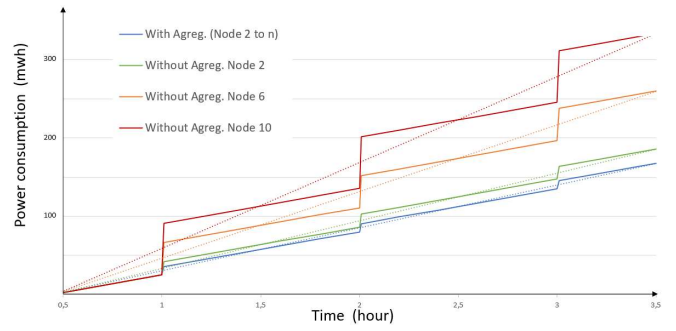

Fig. 9. Energy consumption profiles for intermediate nodes in a chain with a 1-hour collection period

any wireless technology and data gathering process. In case of collection without aggregation, the duration activity exponentially increases with the position of node in the chain (revealing the well-known hot-spot problem).

If all nodes have the same hardware properties, the tendencies (caused by P_s and P_a) are the same in the network. The only change is the duration of activity, which affects the energy consumed by a node. Our models can also calculate the potential energy savings from using (or not) aggregation for data collection. Since these parameters do not change over time and if the required collection frequency remains constant during the application, the total energy consumed by a node can be directly estimated by the number of collection cycles. In this approach, the energy consumed by a node is dependent on the device properties (P_a and P_s), the communication structure, and the collection process and wireless network communication protocols (activity duration).

If applicative needs correspond, the Fig. 9 shows that collecting data using in-network processing technique (aggregation) drastically decreases and uniformizes the energy consumption even for very small chains (by example a node in second position consumes 5 % more energy without aggregation and consumption amounts to 47 % for a node in sixth position). These straightforward yet efficient models can be employed in real-time by individual nodes to evaluate their own remaining lifetime. Distributed routing algorithms can use these predictions to manage the communication network's structure. Additionally, these models can be harnessed by external software, operating in the digital realm, to gain a comprehensive and centralized overview of the energy status of all nodes. Moreover, these models can potentially be applied to Sensing Nodes to facilitate the integration of RF harvesting for recharging purposes.

IV. DISCUSSION

In the modern construction, the convergence of digital and physical components in communicating materials represents a dynamic frontier that is not yet entirely crystallized. However, when delving into the tangible realm of concrete, a solid foundation has been laid to harness its potential in optimizing energy efficiency and promoting longevity, given the present state of knowledge. This innovative system, with its multifaceted applications, holds promise for all prefabricated concrete structures. When examining the lifecycle of a concrete element, it becomes evident that various considerations emerge,

serving as benchmarks for the acquisition of information at different junctures within its lifecycle. For applications within the construction domain, Wireless Sensor Networks (WSN) is an interesting tool, able to capture physical parameters such as humidity, temperature, or corrosion, metrics that exhibit gradual shifts over time. Consequently, the measurement frequencies of these sensors can be judiciously set at relatively low levels, in accordance with the slow pace of physical changes occurring in the concrete and its environment.

The temporal length of each phase in the lifecycle of a concrete element hinges not only on its size but also on the nature of the projects in which it finds utility. The ensuing dataset serves as a compass, offering indicative and generic insights. However, within the context of the models articulated in Section III.C, it facilitates the estimation of the lifespan of communicating concrete:

1. *Manufacturing Phase*: During this initial stage, temperature and humidity must be measured every two hours, to follow a protocol deemed essential in assessing the concrete's maturation.
2. *Logistics/Transport Phase*: when the concrete element embarks on its journey, a daily measurement is then mandated. This phase spans from six months to a maximum of eighteen months.
3. *Construction Phase*: Notably, this phase is the most energetically intensive, especially when the communication capacity is leveraged for the orchestration of construction activities.
4. *Operational Phase*: In this enduring chapter of a concrete element's life, the vigilance extends to the measurement of temperature, humidity, and corrosion. The frequency here shifts to one to two measurements per day. It is presumed that, for residential buildings, an auxiliary energy source will complement our system at this stage.

Considering the above-mentioned data on the lifecycle phases, the energy consumption assessment is as follows: in a beam comprising six interconnected Communicating Nodes, the most energy intensive CNs will consume approximately 50 mWh until being used during the construction phase (during approximately two years). So, a consumption of 0.05 Wh over 2 years is equivalent to a total consumption of 876 Wh. This is a modest amount of energy (for example, these 2 years of consumption represent less than the energy consumption of a light bulb during 4 full days). Barring any material problems and with a judicious utilization of communication capacity during the construction phase, the communicating concrete should remain operational for several decades. This analysis underscores the resilience and longevity of the communicating concrete system, demonstrating its ability to provide sustainable functionality over extended periods.

As we reflect on the developmental maturity of the communicating concrete and the broader construction ecosystem, it becomes evident that significant progress has been made. Prototypes have emerged as tangible evidence, demonstrating not only the feasibility but also the inherent value of this system in perpetuating the continuous flow of information across construction phases. However, the path to

widespread adoption of such an innovative system is not without its challenges. It hinges on the critical factor of cost, particularly the additional expenses incurred by embedded communicating devices. To see this visionary technology embraced by all stakeholders in the construction domain, it is imperative that these costs find collective support across the entire value chain—or at the very least, from those poised to reap substantial benefits from its implementation. In navigating this intricate landscape, we chart a course toward a future where the interplay of holistic software agents and concrete structures is not merely a conceptual aspiration but a tangible reality, fostering greater efficiency, sustainability, and collaborative potential within the construction industry. The road ahead is difficult, but the destination offers a bright future for the construction industry. It's a place where information flows effortlessly, and innovation flourishes.

These thoughts offer a guide to unlock the potential of communicating concrete. It's about blending digital and physical worlds, smartly collecting data throughout the concrete's journey, paving the way for improved sustainability and durability.

V. CONCLUSION AND FUTURE WORKS

This paper presents the main scientific and technological contributions towards the application of the concept of Communicating Materials to the Construction Industry. The preliminary design of communicating concretes' physical part was targeted.

In this article, one of the main challenges concerning the sustainability of the physical part, the energy issue, was especially studied and improved. An original communicating architecture based on a two levels WSN was proposed with Sensing Nodes harvesting the radio energy spent by the Communicating Nodes.

Low-power, wireless, battery-free, energy autonomous, wirelessly powered and controlled Sensing Nodes are reported here and establish a new state of the art in the field for embedded sensors in material. For the first time, a unique antenna is used for simultaneous data transmission and WPT. In future, the overall efficiency of the Wireless Power Transfer system will be optimized by focusing the generated power using beamforming or frequency-diverse arrays techniques. The development of fully integrated prototypes, the integration on flexible substrates and the packaging able of being fully buried in wet concrete are also lines of work.

For Communicating Nodes, two objectives related to WSN energy problem were treated, when they don't need to power the Sensing Nodes: (a) Reduction and (b) Prediction. First objective is relative to the limitation of the energy spent by nodes to collect and transmit data. Reducing the number of messages with data aggregation and optimizing active duration of radio interfaces are the main ways to achieve it. The second objective used the collection options (synchronized chain and aggregation or not) to predict the energy consumed by each *Communicating Nodes* of a chain-based network. As expected, we proved by experiment that data aggregation techniques reduce the number of exchanged messages and therefore reduce the activity of radio interfaces, and so on, the overall spent energy.

In the realm of cutting-edge technological advancements, software agents, basis of the foundational concept of holons (as illustrated in Fig. 2), serve as indispensable features, meticulously encapsulating the state of physical elements at each structural tier—be it sensors, nodes, or the very concrete that shapes our built environment. The communicating concrete and its digital ecosystem has undergone rigorous scrutiny, culminating in thorough testing and validation, extending its reach to seamlessly integrate with Building Information Modeling (BIM) platforms [57]. This convergence of the tangible and the digital realms may empower the construction industry with newfound capabilities and insights. While a communicating material is initially designed to provide data to the digital world, it is also envisaged that the digital world will interact with the physical world, for example by orchestrating its reconfiguration by sending orders. In the future we expect that these predictive models can be used by a wireless sensor network controller able to adapt the collection process with node's failure or node's lack of energy. Moreover, the energy model developed to measure the consumption of a Communicating Material requires to be configured manually. It is thus envisaged to use Artificial Intelligence techniques to identify the model parameters and also to automatically reconfigure the WSN depending on the remaining energy. This reconfiguration process *via* multi-agent systems has been only partly addressed, and additional works and experiments are still needed to be exposed.

REFERENCES

- [1] C. Y. Wong, D. McFarlane, A. A. Zaharudin, and V. Agarwal, "The Intelligent Product Driven Supply Chain," *IEEE SMCyber*, p.4–6, 2002.
- [2] G. G. Meyer, K. Främling, and J. Holmström, "Intelligent Products: A survey," *Comput. Ind.*, vol.60, no.3, p.137–148, 2009.
- [3] J. Jover, A. Thomas, J. M. Leban, and D. Canet, "Interest of new communicating material paradigm: An attempt in wood industry," *Journal of Phys.: Conf. Series*, vol.416, no.1, p.12–31, 2013.
- [4] H. Wan, M. David, and W. Derigent, "Energy-efficient chain-based data gathering applied to communicating concrete," *Int. Journal of Distrib. Sens. Netw.*, vol.16, no.8, p.1550147720939028, 2020.
- [5] S. H. Kosmatka and M. L. Wilson, *Design and Control of Concrete Mixtures*, 2011.
- [6] N. Li and B. Becerik-Gerber, "Life-Cycle Approach for Implementing RFID Technology in Construction: Learning from Academic and Industry Use Cases," *Journal of Constr. Eng. Manag.*, vol.137, p.1089–1098, 2011.
- [7] R. Alonso-Calvo and M. Garcia-Remesal, "A case of study for embedding RFID tags in precast concrete," *LDAC Workshop*, Madrid, Spain, 2016.
- [8] J. Ikonen, A. Knutas, H. Hämäläinen, M. Ihonen, J. Porras, and T. Kallonen, "Use of embedded RFID tags in concrete element supply chains," *Journal of Inf. Technol. in Constr.*, vol.18, p.119–147, 2013.
- [9] S. Jiang and S. V. Georgakopoulos, "Optimum wireless powering of sensors embedded in concrete," *IEEE Trans. Antennas Propag.*, vol.60, no.2, part.2, p.1106–1113, 2012.
- [10] L. Monostori et al., "Cyber-physical systems in manufacturing," *Cirp. Annals*, vol.65, no.2, p.621–641, 2016.
- [11] A. Koestler, *The ghost in the machine*. Hutchinson, 1967.
- [12] J. Paek, J. Hicks, S. Coe, and R. Govindan, "Image-based environmental monitoring sensor application using an embedded wireless sensor network," *Sensors*, vol.14, no.9, p.15981–16002, 2014.
- [13] M. Z. A. Bhuiyan, G. Wang, J. Cao, and J. Wu, "Deploying Wireless Sensor Networks with Fault-Tolerance for Structural Health Monitoring," *IEEE Trans. on Comput.*, vol.64, no.2, p.382–395, 2015.
- [14] T. Rault, "Energy-efficiency in wireless sensor networks," Phd, Université Technologique de Compiègne, Compiègne, 2017.
- [15] H. Teng, X. Liu, A. Liu, H. Shen, C. Huang, and T. Wang, "Adaptive Transmission Power Control for Reliable Data Forwarding in Sensor Based Networks," *Wireless. Commun. Mob. Comput.*, vol.2, 2018.
- [16] M. Nacem, K. Illanko, A. Karmokar, A. Anpalagan, and M. Jaseemuddin, "Energy-efficient cognitive radio sensor networks: Parametric and convex transformations," *Sensors*, vol.13, no.8, p.11032–11050, 2013.
- [17] F. Alfayez, M. Hammoudeh, and A. Abuarqoub, "A Survey on MAC Protocols for Duty-cycled Wireless Sensor Networks," *Procedia Comput. Sci.*, vol.73, no. A-wic, p.482–489, 2015.
- [18] E. Fasolo, M. Rossi, J. Widmer, and M. Zorzi, "in-Network Aggregation Techniques for Wireless Sensor Networks: a Survey," *IEEE Wireless Commun.*, vol.14, no.2, p.70–87, 2007.
- [19] G. Loubet, A. Sidibe, P. Héral, A. Takacs, and D. Dragomirescu, D., "Autonomous Industrial IoT for Civil Engineering Structural Health Monitoring," *IEEE Internet of Things Journal*, 2023.
- [20] P. Kaur, B. S. Sohi, and P. Singh, "Recent Advances in MAC Protocols for the Energy Harvesting Based WSN: A Comprehensive Review," *Wireless Pers. Commun.*, vol.104, no.1, p.423–440, 2019.
- [21] S. Stefanov, G. Frølund, S. S. Zhekov, O. Franek, and G. F. Pedersen, "Dielectric properties of common building materials for UWB propagation studies," *IEEE Antennas & Propag. Mag.*, vol.62, no.1, p.72–8, 2020.
- [22] G. Peruzzi, and A. Pozzebon, "A review of energy harvesting techniques for Low Power Wide Area Networks," *Energies*, vol. 13, no. 13, p. 3433, 2020.
- [23] European Union, "COMMISSION IMPLEMENTING DECISION 2017/1483 of 8 August 2017 amending Decision 2006/771/EC on harmonisation of the radio spectrum for use by short-range devices" *Official Journal of the EU, Decision C(2017) 5464*, 2017.
- [24] T. Perera, D. Jayakody, S. Sharma, S. Chatzinotas, and J. Li, "Simultaneous wireless information and power transfer: Recent advances and future challenges," *IEEE Commun. Surv. & Tut.*, vol.20, no.1, p.264–302, 2017.
- [25] G. Castorina, L. Di Donato, A. F. Morabito, T. Isernia, and G. Sorbello "Analysis and design of a concrete embedded antenna for wireless monitoring applications," *IEEE Antennas and Propag. Mag.*, vol.58, no.6, p.76–93, 2016.
- [26] A. Sidibe, A. Takacs, G. Loubet, and D. Dragomirescu, "Compact Antenna in 3D Configuration for Rectenna Wireless power transfer Applications," *Sensors*, vol. 21, no. 9, p. 3193, 2021.
- [27] "e-peas semiconductors - AEM30940 - datasheet." <https://e-peas.com/wp-content/uploads/2021/03/e-peas-AEM30940-datasheet-RF-Vibration-energy-harvesting.pdf> (accessed May. 22, 2023).
- [28] Doka. Accessed: Apr. 20, 2023. [Online]. Available: <https://www.doka.com/>
- [29] Concrefy. Accessed: Apr. 20, 2023. [Online]. Available: <https://www.concrefy.com/>
- [30] 360 SmartConnect. Accessed: Apr. 20, 2023. [Online]. Available: <https://www.360sc.io/?lang=en>
- [31] idencia - connected concrete. Accessed: Apr. 20, 2023. [Online]. Available: <http://www.idencia.com/connected-concrete>
- [32] CAPTAE et le monitoring des structures Accessed: Apr. 20, 2023. [Online]. Available: <https://term.fr/instruments/captae/captae/>
- [33] TELEMAT - Leading Supplier of Geotechnical & Structural Instrumentation. Accessed: Apr. 20, 2023. [Online]. Available: <https://telemat.fr/en/>
- [34] CEMENTYS - Surveille vos infrastructures. Accessed: Apr. 20, 2023. [Online]. Available: <https://cementys.com/fr/>
- [35] itmsol instrumentation & monitoring. Accessed Apr. 20, 2023. [Online]. Available: <https://www.itmsol.fr/>
- [36] WAKE - powerful wireless concrete temperature monitoring and reporting. Accessed: Apr. 20, 2023. [Online]. Available: <https://www.wakeinc.com/>
- [37] GIATEC - Revolutionizing Concrete Testing. Accessed: Apr. 20, 2023. [Online]. Available: <https://www.giatecscientific.com/>
- [38] LumiCON - Concrete sensors. Accessed: Apr. 20, 2023. [Online]. Available: <https://lumicon.io/concrete-sensors/>
- [39] HILTI - Concrete sensors. Accessed: Apr. 20, 2023. [Online]. Available: <https://www.hilti.com/content/hilti/W1/US/en/services/tool-services/internet-of-things/concrete-sensors.html>
- [40] Maturix. Accessed: Apr. 20, 2023. [Online]. Available: <https://maturix.com/>
- [41] GreenWake Technologies - Remote powering of sensors - no wires, no batteries, no worries. Accessed: Apr. 20, 2023. [Online]. Available: <http://gnw-tech.com/home.htm>
- [42] M. Ceriotti, L. Mottola, G. P. Picco, A. L. Murphy, S. Guna, M. Corra, M. Pozzi, D. Zonta, and P. Zanon, "Monitoring heritage buildings with wireless sensor networks: The Torre Aquila deployment," in *International Conference on Information Processing in Sensor Networks*, pp. 277–288, 2009.
- [43] W. Quinn, P. Angove, J. Buckley, J. Barrett, and G. Kelly, "Design and performance analysis of an embedded wireless sensor for monitoring concrete

curing and structural health,” *Journal of Civil Structural Health Monitoring*, vol. 1, no. 1, pp. 47-59, 2011.

[44] C. Y. Chang, and S. S. Hung, “Implementing RFIC and sensor technology to measure temperature and humidity inside concrete structures,” *Construction and Building Materials*, vol. 26, no. 1, pp. 628-637, 2012.

[45] F. Orfei, C. B. Mezzetti, and F. Cottone, “Vibrations powered LoRa sensor: An electromechanical energy harvester working on a real bridge,” *IEEE SENSORS*, pp. 1-3, 2016.

[46] L. Gallucci, C. Menna, L. Angrisani, D. Asprone, R. S. L. Moriello, F. Bonavolontà, and F. Fabbrocino, “An embedded wireless sensor network with wireless power transfer capability for the structural health monitoring of reinforced concrete structures,” *Sensors*, vol. 17, no. 11, p. 2566, 2017.

[47] D. Bosma, and P. Lindeman, “Autonomous battery less sensor for IoT applications in Smart Buildings: Low-power Energy Conversion and Storage for RF Energy Harvesting,” B.S. Thesis, Delft University of Technology: Delft, Netherlands, 2018.

[48] T. Polonelli, D. Brunelli, M. Guermandi, and L. Benini, “An accurate low-cost Crackmeter with LoRaWAN communication and energy harvesting capability,” in *ETFA The 23rd IEEE International Conference on Emerging Technologies and Factory Automation*, vol. 1, pp. 671-676, 2018.

[49] P. Boccadoro, B. Montaruli, and L. A. Grieco, “Quakesense, a LoRa-compliant earthquake monitoring open system,” in *DS-RT The 23rd IEEE/ACM International Symposium on Distributed Simulation and Real Time Applications*, pp. 1-8, 2019.

[50] D. M. Corva, S. S. Hosseini, F. Collins, S. D. Adams, W. P. Gates, and A. Z. Kouzani, “Miniature resistance measurement device for structural health monitoring of reinforced concrete infrastructure,” *Sensors*, vol. 20, no. 15, p. 4313, 2020.

[51] K. M. Farinholt, G. Park, and C. R. Farrar, “RF energy transmission for a low-power wireless impedance sensor node,” *IEEE Sensors Journal*, vol. 9, no. 7, pp. 793-800, 2009.

[52] G. Paolini, D. Masotti, M. Guermandi, M. Shanawani, L. Benini, and A. Costanzo, “An Ambient-Insensitive Battery-Less Wireless Node for Simultaneous Powering and Communication,” in *EuMC The 50th IEEE European Microwave Conference*, pp. 522-525, 2021.

[53] M. Pizzotti, L. Perilli, M. Del Prete, D. Fabbri, R. Canegallo, M. Dini, D. Masotti, A. Costanzo, E. Franchi Scarselli, and A. Romani, “A long-distance RF-powered sensor node with adaptive power management for IoT applications,” *Sensors*, vol. 17, no. 8, p. 1732, 2017.

[54] R. La Rosa, C. Trigona, G. Zoppi, C. A. Di Carlo, L. Di Donato, and G. Sorbello, “RF energy scavenger for battery-free Wireless Sensor Nodes,” in *I2MTC The IEEE International Instrumentation and Measurement Technology Conference*, pp. 1-5, 2018.

[55] J. Janhunen, K. Mikhaylov, J. Petäjajarvi, and M. Sonkki, “Wireless energy transfer powered wireless sensor node for green IoT: Design, implementation and evaluation,” *Sensors*, vol. 19, no. 1, p. 90, 2019.

[56] H.-Y. Zhou, D.-Y. Luo, Y. Gao, and D.-C. Zuo, “Modeling of Node Energy Consumption for Wireless Sensor Networks,” *Wireless Sensor Networks*, vol.3, no.1, p.18-23, 2011.

[57] A. Roxin, W. Abdou & W. Derigent. Interoperable digital building twins through communicating materials and semantic BIM. *SN Computer Science*, 3, 1-25, 2022.



M. David was born in Gérardmer, France in 1977. He received M.S. degrees in manufacturing systems from the University Henri Poincaré, Nancy, France in 2001 and Ph.D. degree in Computing Engineering and Automatics from Nancy University in 2004.

Since 2005, Dr David is working as an Associated Professor in University of Lorraine and conducting research in CRAN-CNRS laboratory, which is a French research unity located in Nancy. His research interests include concurrent engineering, complex systems organization and management and networking systems with a special focus on wireless sensor networks and Internet of Things and on the way to limit their energy impacts.



W. Derigent is a full Professor at the CRAN laboratory in the University of Lorraine, Nancy, France. After the obtention of a PhD in automated manufacturing in 2006, he dedicated his research to study information management for intelligent products and especially communicating materials, namely materials embedding electronic chips, conferring augmented communication capabilities (data storage and communication). In 2018, he began to explore the notion of cyber-physical production entity, considered as an abstraction of communicating materials, and to study Cyber-Physical Production Systems with a focus on digital twin creation. During his career, he participated to more than 40 conferences, and published regularly in journals with high impact-factors.



G. Loubet (M'20) was born in Toulouse, France, in 1994. He received the Engineer Diploma in Automatic Control and Electronics in 2017 and the Ph.D. degree in Micro- and Nano-Systems, in 2021, both from INSA Toulouse, France. From 2021 to 2022, he was a teaching and research associate with the INSA Toulouse and LAAS-CNRS. Since 2022, he has been an Associate Professor with INSA Toulouse and LAAS-CNRS. He has authored 20 articles in refereed journals communications in international conferences. His research interests include electromagnetic Wireless Power Transfer, wireless communication for the Internet-of-Things applications and Wireless Sensor Networks (WSN) for Cyber-Physical Systems implementation and Structural Health Monitoring applications.



A. Takacs (M'12) was born in Simleu Silvaniei, Romania, in 1975. He received the Engineer Diploma in electronic engineering from the Military Technical Academy, Bucharest, Romania, in 1999, and Ph.D. degree in microwave and optical communications from the National Polytechnic Institute of Toulouse, France, in 2004.

Since 2012, he has been an Associate Professor with the University Paul Sabatier, Toulouse, where he performs research within LAAS-CNRS. He has authored or co-authored 5 international patents, 30 papers in refereed journals, one book, one book chapter, and over 90 communications in international symposium proceedings. His research interests include the design of microwave and RF circuits, energy harvesting and wireless power transfer, small antenna design, electromagnetic simulation techniques, and optimization methods.



D. Dragomirescu (M'96-SM'15) is Professor at INSA Toulouse and LAAS-CNRS laboratory. She received the engineering degree with Magna Cum Laude from the Polytechnic University of Bucharest, Romania in 1996, the MSc in circuits design from the University Paul Sabatier, France, in 1997 and the Ph.D. degree with Magna Cum Laude in 2001 from the University of Toulouse, France.

Prof. Dragomirescu is the Deputy Director of LAAS-CNRS laboratory since January 2022. She is the IEEE Solid States Circuits French Chapter Chair and was French Government Fellow of Churchill College, University of Cambridge in 2014. Daniela Dragomirescu was the Dean of Electrical and Computer Engineering Department at INSA Toulouse since 2017 to 2020. She is conducting research in the area of micro and nano systems for wireless communications with a special focus on Wireless Sensor Networks.