



HAL
open science

Of fake geminates and Ibero-Romance trills: Weight and sonority as two sides of the same coin

Joaquim Brandão de Carvalho

► To cite this version:

Joaquim Brandão de Carvalho. Of fake geminates and Ibero-Romance trills: Weight and sonority as two sides of the same coin. IV Phonoshuttle - Ponte aérea de fonologia, Université de Lisbonne, Université de Porto, 2024, En ligne., France. hal-04420525

HAL Id: hal-04420525

<https://hal.science/hal-04420525v1>

Submitted on 26 Jan 2024

HAL is a multi-disciplinary open access archive for the deposit and dissemination of scientific research documents, whether they are published or not. The documents may come from teaching and research institutions in France or abroad, or from public or private research centers.

L'archive ouverte pluridisciplinaire **HAL**, est destinée au dépôt et à la diffusion de documents scientifiques de niveau recherche, publiés ou non, émanant des établissements d'enseignement et de recherche français ou étrangers, des laboratoires publics ou privés.

**Of fake geminates and Ibero-Romance trills:
Weight and sonority as two sides of the same coin**

Joaquim Brandão de Carvalho

jbrandao@univ-paris8.fr

Université Paris 8, CNRS UMR 7023 SFL

IV Phonoshuttle OPO-LIS

12, 19 / I / 2024

The problem 1

- (1) Ibero-Romance (henceforth IR) languages show a wide variety of rhotics. However, they can all be shown to obey a common system with only two elements, a "strong" and a "weak" one.
- (2) Despite their variability, and for the sake of simplicity, I will refer to them as "trills" and "flaps", and note them with the respective IPA symbols [r] and [ɾ].
- (3) Their distribution is as follows (T = obstruent):¹

	{#,C} V	V V	V {#,C}	T V
[r]	+	+	-	-
[ɾ]	-	+	+	+

As can be seen, complementarity prevails except between vowels: cf. Sp., Port. *carro* 'car' vs. *caro* 'expensive', but Sp. *al[r]ededor* 'around', Port. *guel[r]as* 'gills', Sp. and Port. *hon[r]a* 'honour', *Is[r]ael*, *amo[r]* 'love', *a[r]ma* 'weapon', *p[r]ado* 'prairie'.

No other consonants display such a distribution in IR. This idiosyncrasy needs explanation.

¹ Trills may be occasionally allowed in coda, especially as emphatic allophones: cf. Lipski (1990: 159–162).

The problem 2

Two questions will be addressed here.

(4) Why is it that complex onsets and codas disallow [r]?

The question of why the word-initial and post-coda positions disallow [r] will be left aside.

(5) Why are trills unattested in the onset of the penultimate syllable of proparoxytonic words in Portuguese and in Spanish:

Port. cátaro 'cathar' and *catarro* 'phlegm' vs. *cátarro

Solution 1: Trills are geminates 1

(6) IR trills are coda-onset sequences while flaps are singletons (Câmara Jr. 1953).

More specifically, trills are (lexical or derived) geminates that require two slots – López (1979), Monaretto (1997), Wetzels (1997), Mateus & Andrade (2000), Abaurre & Sandalo (2003) – or "mirror consonants" based on two CV's, the first being empty while giving /r/ a strong position following Strict CV (Scheer 2004, Ségéral & Scheer 2008) – Souza (2019).

(7) This hypothesis has two benefits.

- a. If the trill is a geminate, it cannot occur in complex onsets nor in coda position: neither triple onsets nor double codas are allowed in IR languages.²
- b. This may be the reason why trills cannot occur in the onset of the penultimate syllable of proparoxytones in Portuguese and Spanish, assuming, with Carvalho (1989) and Wetzels (2007), that stress cannot fall before the antepenultimate mora of the word.

² Double codas are apparently found in a few learned words like *perspectiva*, but they can be analysed differently.

Solution 1: Trills are geminates 2

(8) However, trills can hardly be geminates in modern IR languages for at least four reasons.

- a. As opposed for example to Latin, Italian, Arabic, Finnish or Gascon (which shows Lat. R- > *arr-*: see Labrune & Miró-Lozano 2022) where all consonants can be geminates, trills would be the *only* geminates in the language, which runs counter to length typology.
- b. As trills are given preference in word-initial position, this single geminate would be possible word-initially, a highly marked context for a geminate.³
- c. This putative word-initial geminate lacks its unmarked counterpart, which contrasts with the expected markedness-based universal implication.
- d. Assuming that they are geminates, post-consonantal trills, as in *honra* and *melro*, would involve a double coda which is disallowed in Portuguese and Spanish.

³ Note that Italian trills, which are true geminates, do not regularly occur word-initially except in cases of *raddoppiamento sintattico*.

Solution 2: Trills are complex onsets 1

(9) The facts mentioned so far suggest that IR trills may differ from flaps in that they are *bipositional*, *fortis* and *heavy* segments, albeit not geminates.

- a. They are bipositional as they are disallowed in TR onsets unlike flaps.
- b. They are fortis as they are the only rhotic consonant admitted in "strong position", that is word-initially and after a coda, weak segments being marked in strong contexts.

Note that *[#r] is active in many languages. Also, *[N.l], *[N.r], *[l.r]. are impossible clusters that do not satisfy the Sonority sequencing principle (SSP) (Selkirk 1984, Clements 1990), only [l.N] (*alma*), [r.N] (*arma*), [r.l] (*Carlos*), [N.r] (*genro*) and [l.r] (*melro*) being attested, which reveals the (decreasing) sonority scale $r > l > N, r$.

- c. Trills are heavy in that they cannot occur in the penultimate syllable of proparoxytones contrary to flaps.

Solution 2: Trills are complex onsets 2

- (10) Leaving aside the question of weight for the moment, I would point out that IR has bipositional and fortis onsets: TR clusters, whose liquid element (= R) can be a rhotic.

I will claim, developing and refining an idea by Lipski (1990), that the trill is a complex "RR" *onset*.

- (11) Two interesting facts are provided by historical evolution, which shows, on the one hand, that TR onsets can change into [r], as exemplified with (Old) French data:

Lat. LAT[r]ONE > Old Fr. *la[r]on* *larron* 'thief'

Lat. *PAT[r]ANU > Old Fr. *pa[r]ain* *parrain* 'godfather'

Lat. PET[r]A > Old Fr. *pie[r]e* *pierre* 'stone'

Lat. QUAD[r]ATU > Old Fr. *qua[r]é* *carré* 'square'

These changes suggest that $T_r > r$ is a compensatory lengthening process, bringing evidence for the claim that both T_r and r involve two timing slots.

Solution 2: Trills are complex onsets 3

(12) On the other hand, trills and TR's play the same role in avoiding clusters that violate the SSP (cf. Lipski 1990, Carvalho 2008), as can be shown by comparing Portuguese rhotic fortition to French plosive epenthesis:⁴

a. Lat. MER(U)LU	> * <i>me[rɫ]u</i>	> Port. <i>mel[r]o</i>	<i>melro</i>	'blackbird'
Lat. HON(O)RARE	> * <i>ho[nr]ar</i>	> Port. <i>hon[r]ar</i>	<i>honrar</i>	'honour _{INF} '
Lat. GEN(E)RU	> * <i>ge[nr]u</i>	> Port. <i>gen[r]o</i>	<i>genro</i>	'son-in-law'
b. Lat. MOL(E)RE	> * <i>mo[lr]e</i>	> Old Fr. <i>mou[dr]e</i>	<i>moudre</i>	'grind _{INF} '
Lat. CIN(E)RA	> * <i>ce[nr]e</i>	> Old Fr. <i>cen[dr]e</i>	<i>endre</i>	'ash'
Lat. GEN(E)RU	> * <i>ge[nr]u</i>	> Old Fr. <i>gen[dr]e</i>	<i>gendre</i>	'son-in-law'

⁴ Note that (12a) may involve metathesis: we have **merlu* > Port. *melro*, as in **ge[nr]u* > Sp. *yerno* along with **ho[nr]ar* > Sp. *hon[r]ar* 'honour' with rhotic fortition.

Solution 2: Trills are complex onsets 4

- (13) And yet, there is still a problem: only the RR has weight, not TR (cf. Sp., Port. *cátedra* 'chair' vs. **cátterra*).
- (14) Moraic phonology (Hyman 1985) can provide the following representations, where trills (b) are linked to one additional mora contrary to flaps (a) and TR onsets (c).

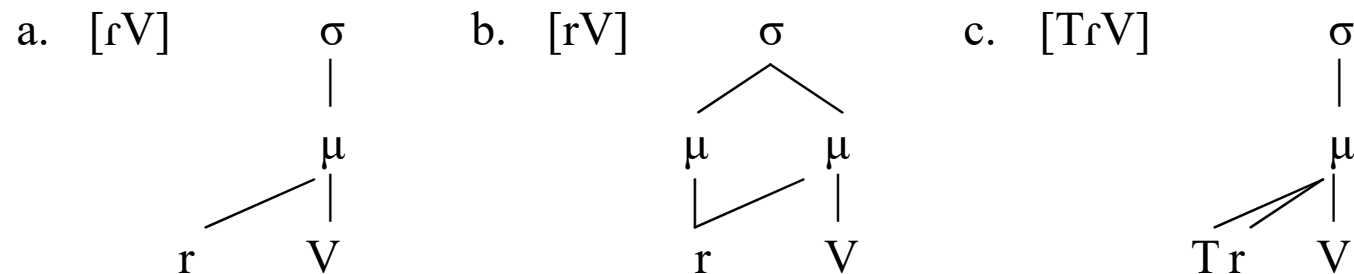

If trills are long, it can be argued, given the tenets of Moraic phonology where moras are the only skeletal units, that long segments like [r] are necessarily heavy.

- (15) However, the moraic account still raises the same problem as the geminate hypothesis: why should rhotics be the only consonants to be moraic in onset position? Given (14b), there is no reason why any consonant in onset position cannot be moraic.

Solution 2: Trills are complex onsets 5

- (16) Here we come to the heart of the problem: these data suggest that the current representation of two phonological dimensions, weight and sonority, is not appropriate.

In (14), the two aspects are formalised separately: weight is expressed by the moraic skeleton while sonority is based on features like [\pm consonantal], [\pm sonorant] or [\pm continuant] (generally represented by means of IPA symbols).

It will be proposed here that sonority is not pure melody; it is not based on features but, just like weight, on *structure* (Carvalho 2017, 2023; see also Pöchtrager 2006 for a similar hypothesis on the structural nature of many properties hitherto held to be melodic, although based on an entirely different model).

To this end, an overview of what was called Alignment Theory of sonority (henceforth AT) is necessary.

Unifying sonority and weight: C/V alignments and sonority 1

(17) AT combines the following features:

- a. Consonants and vowels are universally segregated,
- b. and involve two parallel ONON sequences, on the C-plane and on the V-plane,
- c. which are variably synchronized across an x-skeleton, different *C/V alignments* giving rise to the several sonority-based categories (plosives, fricatives, liquids, glides etc.),
- d. and, crucially, may differ in length.

(18) C/V segregation rests on a large body of evidence: acoustic (Öhman 1966), articulatory (Fujimura 1992), acquisitional (McDonough & Myers 1991; Macken 1992) and cognitive (Obleser *et al.* 2010) data support the view that consonants and vowels belong to separate channels in the speech "plan", but interact through implementation in the same vocal tract.

(19) The periodic ONON...ON sequence is based on what constitutes the foundation of Strict CV (Lowenstamm 1996; Scheer 2004), whose earlier version, classic Government Phonology (see, *e.g.*, Charette 1991), distinguished between the sequence of syllable constituents and the skeleton made of x-slots (Vergnaud 1982; Levin 1983).

Unifying sonority and weight: C/V alignments and sonority 3

(21) It follows from (17c) that the skeleton is the locus through which the C- and the V-planes interact in such a way that several alignments are allowed. As shown below, these C/V alignments (in bold) define various sonority categories according to which elements of the two planes are synchronized. Four consonantal categories are represented in (a-d): T = plosive, T^S = affricate, S = fricative, R = sonorant, V in (e) being a vowel.

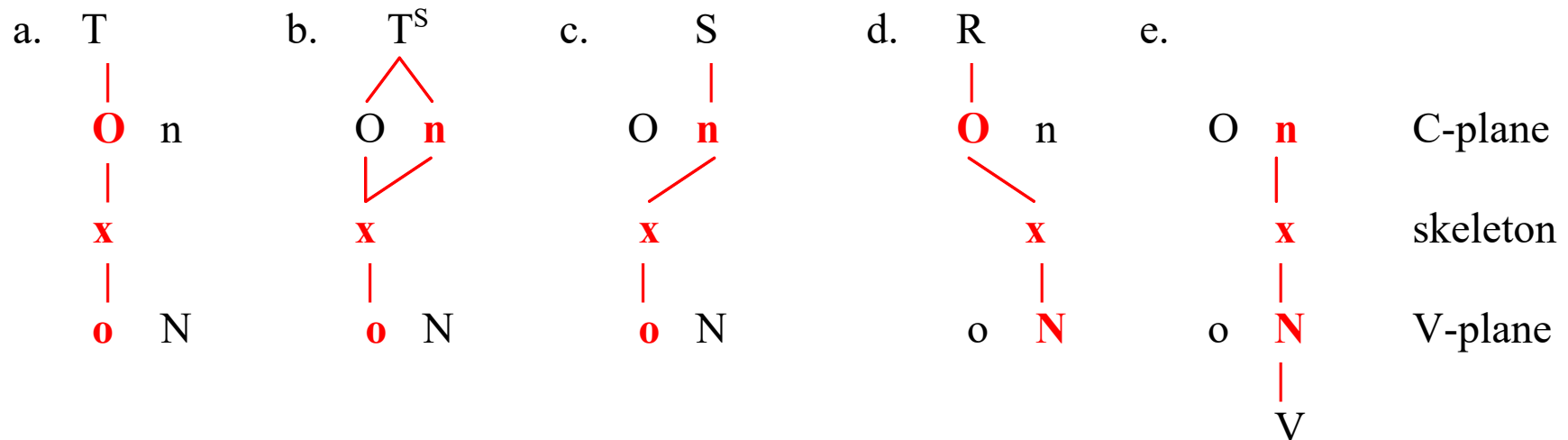

Unifying sonority and weight: C/V alignments and sonority 4

(22) The above alignments, which generally bear melodic content, are *free*: at least one of their vertices is unshared by other alignments. They can interact with one another in such a way that other putative features prove to be based on structure as well. This is shown below for VOT categories which emerge from O-N *bound* alignments (Carvalho 2008).

Here I take /t/ (= coronal) and /a/ as representatives of plosives and vowels: /ta/ = voiceless (unmarked configuration), /t^ha/ = aspirated or *fortis*, /da/ = voiced or *lenis*, /d^ha/ = breathy voice (hypermarked configuration).

a. /ta/

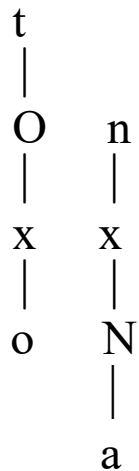

b. /t^ha/

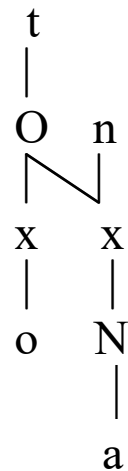

c. /da/

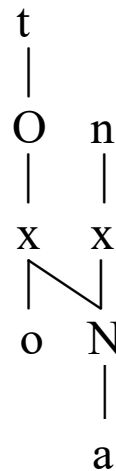

d. /d^ha/

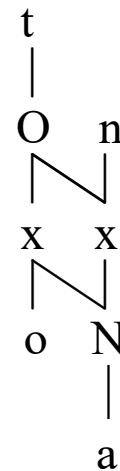

C/V asymmetry, phonotactic constraints, and weight 1

(23) In systems with significant phonotactic constraints, *e.g.* TR onsets and/or restrictions on the coda, (17d) is crucial: for example, it follows from (17d) that AT can generate, among other structures, the two following syllable types where the C-plane is longer than the V-plane.

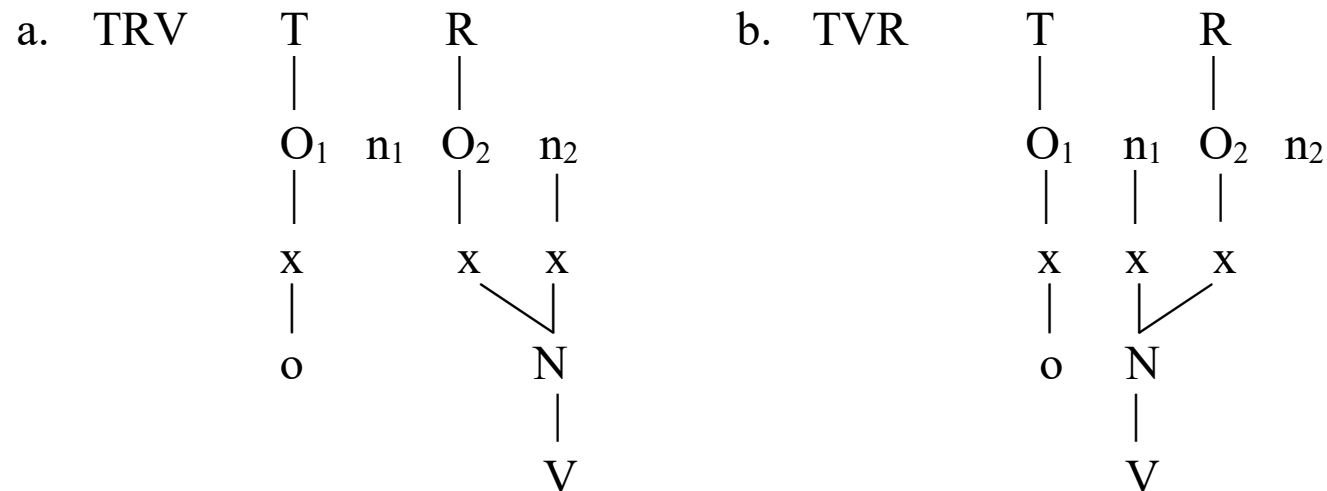

(23b) is particularly interesting in languages like IR where most (true) codas are sonorants.

C/V asymmetry, phonotactic constraints, and weight 2

(24) If the V-plane is longer than the C-plane, alignments can lead for example to diphthongs (a) or long vowels (b).

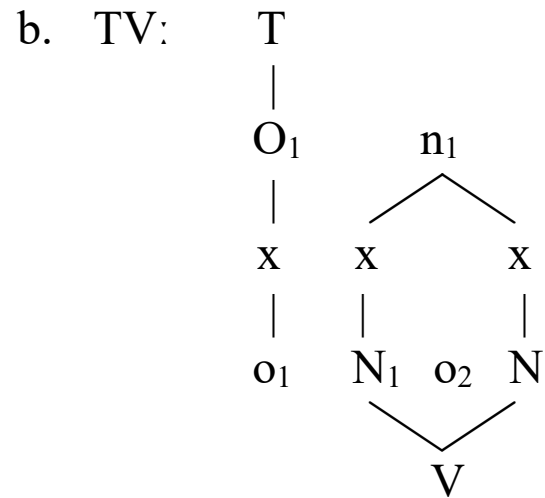
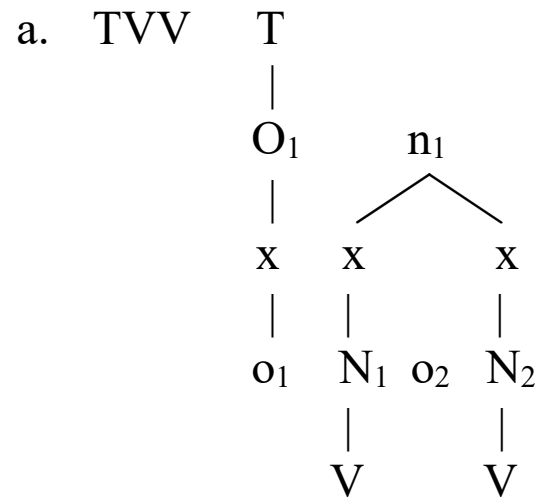

C/V asymmetry, phonotactic constraints, and weight 3

(25) Let us assume that moras are *N-n alignments*. Hence, not only are the diphthongs and long vowels in (24) bimoraic, but the structures in (23a,b) can be reformulated as in (a,b) below, where both syllables worth 2 moras as they show 2 N-n alignments as well.

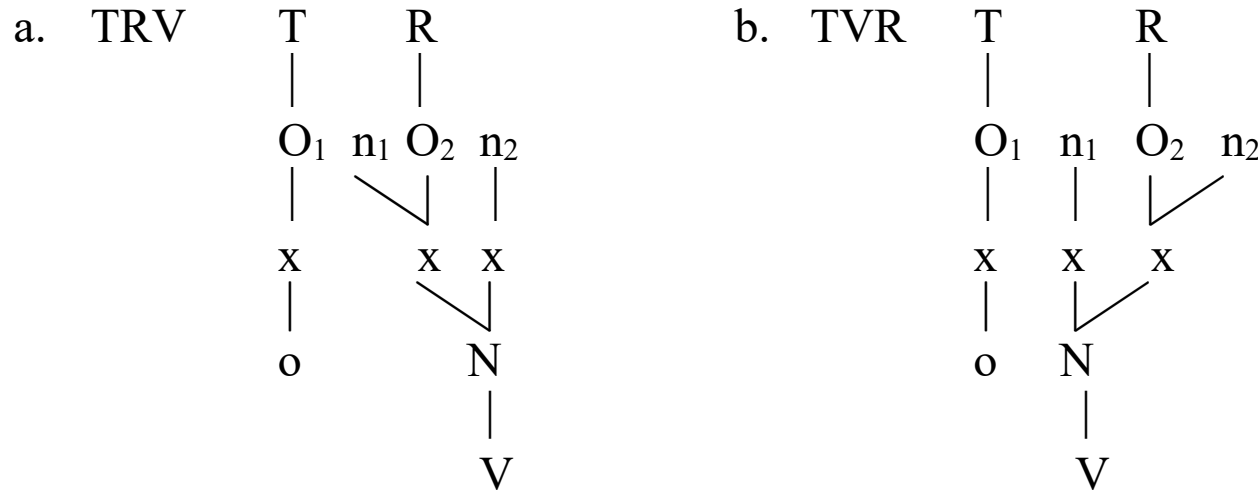

Note that (a,b) cannot represent TVRV, since neither (a) n₁-N nor (b) n₂-N alignments have an x-slot of their own. Thus, vowels (21e) are necessarily moraic but moraicity does not imply vowelness.

C/V asymmetry, phonotactic constraints, and weight 3

- (26) a. Note that TR onsets can be moraic, as in Samothraki Greek (Topintzi 2010) and, interestingly, Latin, as shown by changes like TENÉBRA > Sp. *tiniebla* or TONÍTRU > Fr. *tonnerre* whose penultimate syllable was heavy despite its short vowel.
- b. Also, sonorant codas were and still are moraic in Romance: cf. Carvalho (1989) and Wetzels (2007) for Portuguese.
- c. Both TRV and TVR can thus be assumed to have possessed the representations in (25a) and (25b) respectively in early Romance.

Trills as complex onsets: length

(27) The representation of TR onsets in (25a) and that of voiced consonants in (22c) provide an explanation of how the former may change into trills, as in (Lat. LATRONE >) **la[dro]n* > Old French *la[ro]n* (*larron*) 'thief' (cf. 11). As shown below, this change is simply due to the delinking of *o* in the V-plane, which entails the loss of the intervocalic voiced plosive (by virtue of regular Western Romance consonant lenition), and R compensatory association.

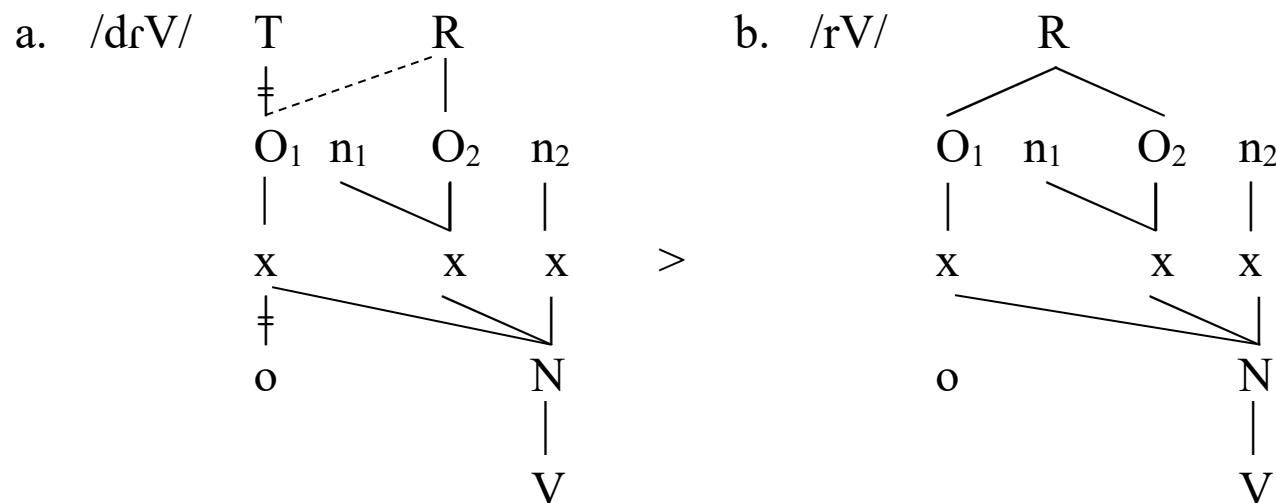

Hence, the trill happens to be a bipositional sonorant albeit being tautosyllabic.

Trills as complex onsets: weight

(28) Let us now compare the representations under (a) and (b).

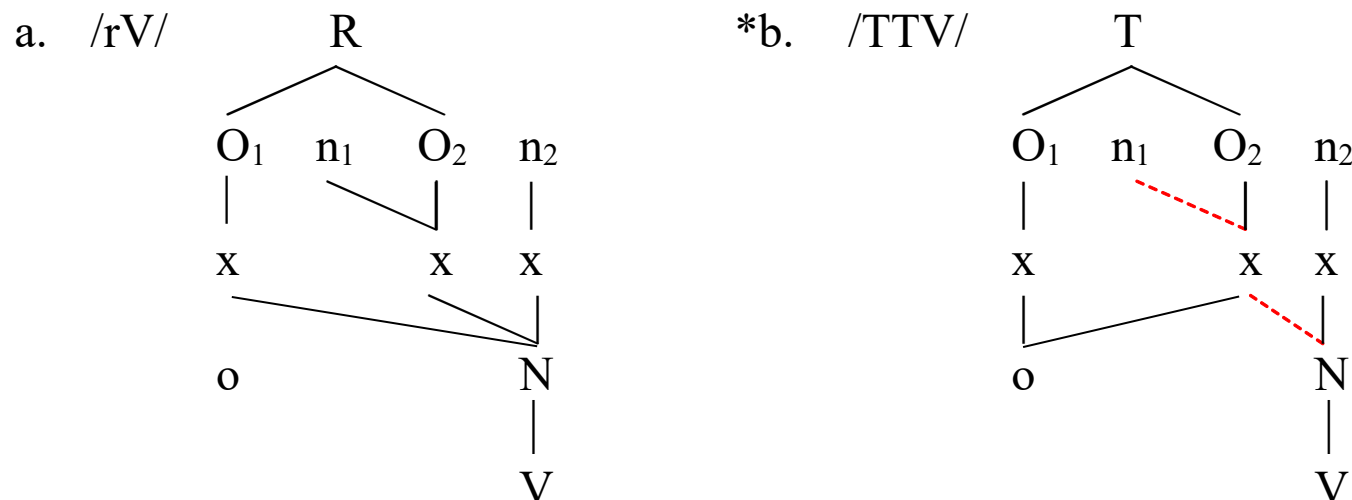

The structure in (a) is bimoraic as it contains two n-N alignments.

The structure in (b) can be illustrated by long plosive onsets like those found in Swiss German (Kraehenmann 2001) and elsewhere. Crucially, such onsets cannot be moraic. If there were an n_1 -N alignment in (b), the representation would be ill-formed since alignments *do not cross* for the very same reason as classic association lines: to avoid linearity violation. Hence, not only can RR onsets be moraic, but *only* RR onsets can be so.

Concluding

In sum, if IR trills involve the same configuration as (heavy) TR onsets, i.e. the one in (29):

(29) /rV/

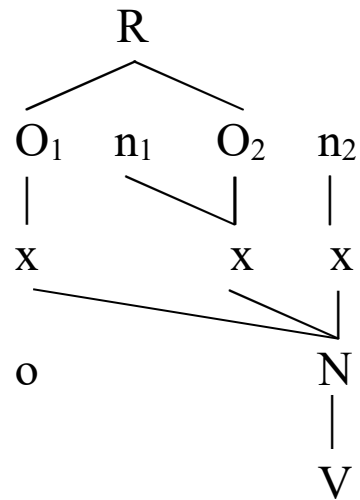

- then:
- (i) there can be bipositional sonorants in a language that lacks geminates;
 - (ii) moras being n-N alignments, only sonorants are allowed to be moraic in onset position.

Point (i) avoids the problems raised by the geminate hypothesis, while point (ii) solves the mystery of moraic trills in syllable onsets.

Acknowledgements

I am grateful to Mathilde Hutin for her contribution to my thinking on the phonology of rhotics.

References

- Abaurre, Maria Bernadete Marques & Sandalo, Maria Filomena Spatti. 2003. Os róticos revisitados. In Dermeval da Hora & Gisela Collischonn (eds.), *Teoria lingüística: fonologia e outros temas*, 144–180. João Pessoa: Editora Universitária UFPB.
- Câmara Jr., Joaquim Mattoso. 2002 [1953]. *Estrutura da Língua Portuguesa*. 35th ed. Petrópolis: Vozes.
- Carvalho, Joaquim Brandão de. 1989. Phonological conditions on Portuguese clitic placement: on syntactic evidence for stress and rhythmical patterns. *Linguistics* 27. 405-436.
- Carvalho, Joaquim Brandão de. 2008. From positions to transitions: A contour-based account of lenition and fortition. In Brandão de Carvalho, Joaquim & Scheer, Tobias & Ségéral, Philippe (eds.), *Lenition and Fortition*, 415-445. Berlin: Mouton-DeGruyter.
- Carvalho, Joaquim Brandão de. 2017. Deriving sonority from the structure, not the other way round: A strict CV approach to consonant clusters. *The Linguistic Review* 34(4). 589–614.
- Carvalho, Joaquim Brandão de. 2023. The paradox of Portuguese /Vr/-rhymes: Disentangling weight from length via structure-based sonority. *Glossa: a journal of general linguistics* 8(1), 1-23.
- Charette, Monik. 1991. *Conditions on phonological government*. Cambridge: Cambridge University Press.
- Fujimura, Osamu. 1992. Phonology and phonetics: A syllable-based model of articulatory organization. *Journal of the Acoustical Society of Japan* 13. 39–48.
- Hyman, Larry M. 1985. *A theory of phonological weight*. Dordrecht: Foris.

- Kraehenmann, Astrid. 2001. Swiss German stops: geminates all over the word. *Phonology* 18. 109–145.
- Labrune, Laurence & Miró-Lozano, Joël. 2022. Les consonnes rhotiques du gascon revisitées. *Linx* 84. DOI : <https://doi.org/10.4000/linx.9159>
- Levin, Juliette. 1983. Dependent levels of representation: the skeletal tier and syllabic projections. Paper presented at the 8th GLOW Meeting, York.
- Lipski, John M. 1990. Spanish taps and trills: Phonological structure of an isolated opposition. *Folia linguistica* 24. 153–174.
- López, Barbara Strodt. 1979. *The sound pattern of Brazilian Portuguese (Cariocan Dialect)*. Ph.D. Los Angeles: University of California.
- Lowenstamm, Jean. 1996. CV as the Only Syllable Type. In Durand, Jacques & Laks, Bernard (eds.), *Current Trends in Phonology: Models and Methods*, vol. 2, 419-441. CNRS, Paris X: ESRI.
- Macken, Marlys A. 1992. Where's phonology? In Ferguson, Charles A. & Menn, Lise & Stoel-Gammon, Carol (eds.), *Phonological development: Models, research, implications*, 249–269. Timonium, Maryland: York Press.
- Mateus, Maria Helena Mira & Andrade, Ernesto d'. 2000. *The Phonology of Portuguese*. Oxford: Oxford University Press.
- McDonough, Joyce & Myers, Scott. 1991. *Consonant harmony and planar segregation in child language*. Manuscript. Austin: UCLA and University of Texas.
- Monaretto, Valéria Neto de Oliveira. 1997. *Um reestudo da vibrante: análise variacionista e fonológica*. Ph.D. Porto Alegre: Pontificia Universidade Católica do Rio Grande do Sul.

- Obleser, Jonas & Leaver, Amber M. & VanMeter, John & Rauschecker, Josef P. 2010. Segregation of vowels and consonants in human auditory cortex: evidence for distributed hierarchical organization. *Frontiers in Psychology* 1. Article 232.
- Öhman, Sven Erik Gustav. 1966. Coarticulation in VCV utterances: Spectrographic measurements. *Journal of the Acoustical Society of America* 39. 151–68.
- Pöchtrager, Markus. 2006. *The Structure of Length*. Ph.D. University of Vienna.
- Scheer, Tobias. 2004. *A lateral theory of phonology: What is CVCV, and why should it be?* Berlin: Mouton de Gruyter.
- Ségéral, Philippe & Scheer, Tobias. 2008. The Coda Mirror, stress and positional parameters. In Brandão de Carvalho, Joaquim & Scheer, Tobias & Ségéral, Philippe (eds.), *Lenition and Fortition*, 483-518. Berlin: Mouton de Gruyter.
- Souza, Andréia de. 2019. Portuguese rhotic consonants: Evidence for the coda mirror. Manuscript.
- Topintzi, Nina. 2010. *Onsets: Suprasegmental and prosodic behaviour*. Cambridge: Cambridge University Press.
- Vergnaud, Jean-Roger. 1982. On the theoretical bases of phonology. Paper presented at the 7th GLOW Meeting, Paris.
- Wetzels, W. Leo. 1997. The lexical representation of nasality in Brazilian Portuguese. *Probus* 9(2). 203–232.
- Wetzels, W. Leo. 2007. Primary stress in Brazilian Portuguese and the quantity parameter. *Journal of Portuguese Linguistics* 5/6. 9–58.