



**HAL**  
open science

# Net-negative emission opportunities for the iron and steel industry on a global scale

Carlos Andrade, Lucas Desport, Sandrine Seloisse

## ► To cite this version:

Carlos Andrade, Lucas Desport, Sandrine Seloisse. Net-negative emission opportunities for the iron and steel industry on a global scale. *Applied Energy*, 2024, 358, pp.122566. 10.1016/j.apenergy.2023.122566 . hal-04411124

**HAL Id: hal-04411124**

**<https://hal.science/hal-04411124>**

Submitted on 13 Mar 2024

**HAL** is a multi-disciplinary open access archive for the deposit and dissemination of scientific research documents, whether they are published or not. The documents may come from teaching and research institutions in France or abroad, or from public or private research centers.

L'archive ouverte pluridisciplinaire **HAL**, est destinée au dépôt et à la diffusion de documents scientifiques de niveau recherche, publiés ou non, émanant des établissements d'enseignement et de recherche français ou étrangers, des laboratoires publics ou privés.

# Net-negative emission opportunities for the iron and steel industry on a global scale

Carlos ANDRADE<sup>1</sup>, Lucas DESPORT<sup>2,3</sup>, Sandrine SELOSSE<sup>2</sup>

<sup>1</sup>IFP Energies Nouvelles, 1-4 Avenue de Bois-Préau, 92852 Reuil-Malmaison, France

<sup>2</sup>Mines Paris - PSL, CMA - Centre for Applied Mathematics, Rue C. Daunesse, 06904 Sophia Antipolis, France

<sup>3</sup>TotalEnergies, OneTech, 2 place Jean Millier, 92078 Paris la Défense, France

## Graphical abstract

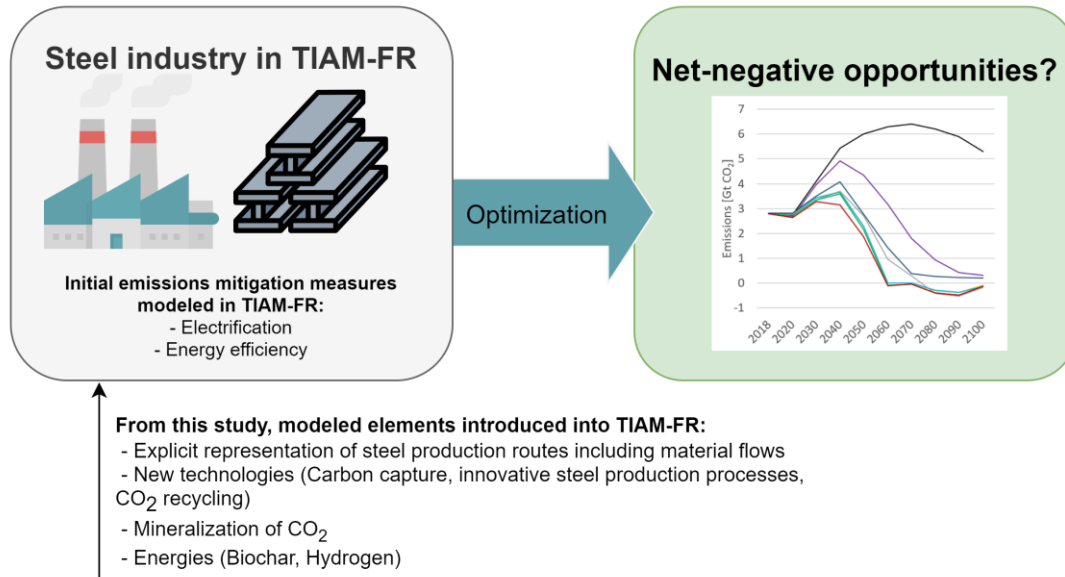

## Abstract

The iron and steel industry is a high energy-intensive and polluting sector, and its production is expected to increase in the coming decades. Therefore, the steel sector must follow a sustainable pathway to align with climate objectives. However, its decarbonization is challenging, as even replacing all fossil fuels with renewable energies, or developing new low-carbon technologies would not eradicate the CO<sub>2</sub> emissions produced from the use of carbon-bearing materials. To achieve carbon neutrality in the steel industry, the use of biomass with carbon capture and storage/utilization can be an effective strategy as it can produce negative emissions to compensate for residual ones. In this regard, this study aims to analyze the role of negative emission technologies in the decarbonization of the steel sector using a mathematical energy prospective modeling tool called TIAM-FR. The analysis includes a literature review to identify potential applications of biomass in existing and innovative steel production technologies, which are integrated into the modeling tool. Additionally, efforts have been made to accurately identify in the model the sources of fossil and biogenic emissions to assess the feasibility of negative emission production. By implementing various scenarios, the study examines how negative emission technologies can contribute to decarbonizing the steel industry and thus help the industry achieve its climate objectives. The results highlight the necessity for the steel

sector to pursue a net negative emissions pathway to achieve carbon-free steel production and support the decarbonization of other sectors. Without the use of biomass in the steel industry, the marginal cost of steel would significantly increase. The COREX and the direct reduction of iron coupled with carbon capture and storage technologies are key to deploying negative emissions in the steel sector, while other low-carbon technologies such as the electric arc furnace and the iron electrolysis also play crucial roles. International collaboration may be necessary to optimize global decarbonization investments and ensure effective implementation of negative emission technologies in the steel sector.

**Keywords:** Negative emission technologies, Bioenergy, CCS, Long-term energy modeling, Steel industry, TIMES modeling.

## 1. Introduction

### 1.1. Challenges in decarbonizing the steel industry.

Steel is an essential material for human development, since it is used in buildings, vehicles, energy infrastructure, etc. [1]. Steel demand in 2019 was 1.9 Mt and is expected to grow 30% by 2050 following the development of emerging economies and the transition to a low-carbon economy [2]. However, steelmaking is one of the most energy-consuming and polluting industries. In 2019, steel production accounted

List of abbreviations			
<b>2C</b>	Scenario limiting the rise of global temperatures to 2°C	<b>IISB100</b>	Scenario taking into consideration 100-year rotation period for biomass
<b>AFR</b>	Africa	<b>IISB50</b>	Scenario taking into consideration 50-year rotation period for biomass
<b>AUS</b>	Australia and New Zealand	<b>IND</b>	India
<b>BECCS</b>	Bio energy with carbon capture and storage	<b>ISO</b>	Scenario carbon neutrality for the steel sector with global cooperation
<b>BECCU</b>	Bio energy with carbon capture and utilization	<b>ISI</b>	Iron and steel industry
<b>BF-BOF</b>	Blast furnace basic oxygen furnace	<b>JPN</b>	Japon
<b>BF-BOF-TGR</b>	Blast furnace basic oxygen furnace with top gas recycling	<b>LCA</b>	Life cycle analysis
<b>CAN</b>	Canada	<b>LUC</b>	Land use change
<b>CCS</b>	Carbon capture and storage	<b>MEA</b>	Middle East
<b>CCU</b>	Carbon capture and utilization	<b>MEX</b>	Mexico
<b>CSA</b>	Latin and central America	<b>NE</b>	Negative Emissions
<b>DRI-EAF</b>	Direct reduction of iron coupled with an electric arc furnace	<b>NETs</b>	Negative emission technologies
<b>EAF</b>	Electric arc furnace based on steel scarp	<b>NPV</b>	Net present value
<b>EEU</b>	Eastern Europe	<b>ODA</b>	Other developing countries of Asia
<b>FSU</b>	Former Soviet Union	<b>PA</b>	Paris agreement
<b>GDP</b>	Gross domestic product	<b>REF</b>	Reference scenario
<b>GHG</b>	Greenhouse gases	<b>RES</b>	Reference energy system
<b>GWP</b>	Global warming potential	<b>SKO</b>	South Korea
<b>DRI-H2</b>	Direct reduction of iron using hydrogen	<b>SSP2</b>	Shared socio-economic pathways
<b>Hlsarna</b>	High Intensity smelting - Isarna = iron in Celtic	<b>TIAM-FR</b>	French version of the TIMES integrated assessment model
<b>IAM</b>	Integrated assessment model	<b>TIMES</b>	The integrated Markal-Efom System
<b>IIASA</b>	International Institute for Applied Systems Analysis	<b>USA</b>	United States of America
<b>IISO_R</b>	Scenario carbon neutrality for the steel sector without global cooperation	<b>WEU</b>	Western Europe
<b>IISBO</b>	Scenario limiting the use of biomass in the steel sector		

for 7% (2.6 Gt of CO<sub>2</sub> in 2019) of global anthropogenic CO<sub>2</sub> emissions [3]. This can be explained by the fact that the industry depends massively on fossil fuels. Indeed, 70% of current steel production relies on the blast furnace-basic oxygen furnace route (BF-BOF) [4] using coke as a fuel and as the main iron ore reducing agent. The BF-BOF carbon intensity can vary from 1.4 to 2.4 t CO<sub>2</sub>/t steel [5, 6], and its total energy consumption can reach almost 20 PJ/t steel. The rest of steel production relies on the electric arc furnace route (EAF) (23%) and on the direct reduction of iron coupled with an EAF (DRI-EAF) (7%). The EAF uses steel scrap as a ferrous material source, and considerably reduces the use of coal, which represents around 20% of the energy consumed and is responsible for most of the emissions from this route. Coal in this process is used to foam slag which serves to improve the performance of the furnace [7]. The EAF emits between 0.1 to 0.9 t CO<sub>2</sub>/t steel and can reach an energy intensity of around 5 PJ/t steel. The DRI-EAF route completely eliminates the use of coke and mainly uses natural gas as the fuel and reducing agent<sup>1</sup>. Its energy intensity can be around 14–20 PJ/t steel, and emissions can reach 0.9 t CO<sub>2</sub>/t steel. Figure 1 presents the world energy consumption and CO<sub>2</sub> intensity for each steel-producing route in 2018. Therefore, the iron and steel industry (ISI) is required to follow a more sustainable trajectory if it aims to contribute to global climate targets.

The decarbonization pathway of the ISI is challenging. First, any improvements in energy efficiency could be

overcompensated by an increase in production, and higher efficiency within the BF-BOF route is hard to achieve as this technology is very mature and widely deployed [9, 10]. Second, coke cannot be easily replaced as it possesses the most suitable physical and chemical characteristics for producing high-quality iron [11]. Third, part of the direct CO<sub>2</sub> emissions from the ISI (around 8%) come from the use of other carbon-bearing materials, mainly limestone (which helps to reduce the impurities in the iron ore), making these emissions inevitable<sup>2</sup>. Shifting to less polluting steelmaking technologies is also complicated. The deployment of the EAF is limited by the availability of scrap, which is already insufficient to satisfy increasing steel demand, coupled with the fact that some steel scrap does not present the required characteristics to produce high-quality steel end-products [12]. The DRI-EAF route primarily relies on natural gas as the main iron-reducing agent, resulting in up to 60% fewer emissions compared to the traditional BF-BOF route. This presents a viable option for producing steel with a lower environmental impact in regions that have access to cheap natural gas resources. However, it is unlikely that the DRI-EAF route will completely replace the BF-BOF, as there are certain locations where the BF-BOF remains the most cost-effective option [13], particularly where coal remains economically competitive and no carbon taxes are enforced.

Other innovative low-carbon steel-producing technologies can help reduce the sector's emissions [14]. For

<sup>1</sup> Current Indian DRI processes use coal as the main fuel and reducing agent, which highly increases the CO<sub>2</sub> intensity of this route in the country (8).

<sup>2</sup> Emissions that come from the use of non-energy materials are called process emissions.

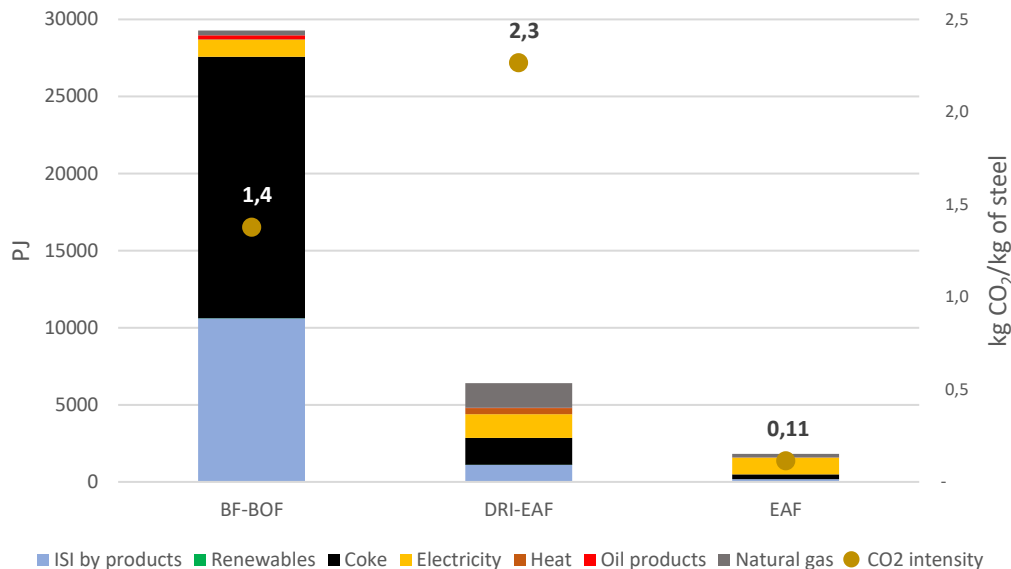

**Figure 1:** Final energy consumption and CO<sub>2</sub> emissions intensity by steel producing route in 2018.

example, it is possible to completely shift to the direct use of coal, e.g. Hlsarna or COREX<sup>3</sup>, or more efficient technologies using natural gas, e.g. ULCORED<sup>4</sup>. Yet although these options are less polluting, they might not be commercially available before 2030 and still consume fossil fuels, which can create a carbon lock-in. Another possibility is to replace natural gas with hydrogen in the DRI-EAF route (DRI-H<sub>2</sub>). This option will only be viable if the cost of electricity and electrolysis remains low. Very low-carbon steel production technologies (ULCOWIN<sup>5</sup>, ULCOLYSIS<sup>6</sup>) relying on the electrolysis of iron ore might be available by the middle of the century, as these technologies have to overcome some technical barriers before being commercially available [15]. In addition, the transition to new steel production technologies is likely to be affected by economic aspects as they are more expensive; this will worsen the economic performance of the industry, which already suffers from low profit margins [16]. As a result, the BF-BOF route might still play an important role in the production of steel in the future.

Subsequently, this situation could call for incorporating innovative technologies into the different steel production routes in synergy with carbon capture and storage (CCS) and/or utilization (CCU) technologies [15]. Many countries already propose deploying CCS to help decarbonize key industrial clusters [17]. However, CCS technologies can only capture up to 90% of emissions in the ISI [18], therefore other solutions to compensate for residual emissions have to be deployed in parallel.

Another decarbonization option consists in replacing part of the fossil fuels with renewable energies from biomass

products [19]. Raw biomass cannot be used massively in steel-producing processes due to its high moisture, volatile matter content, low calorific value, and low grindability, etc., meaning it needs to be transformed [20]. By heating solid biomass at 600 °C it is possible to produce charcoal [21]. Charcoal can replace some of the coke used in the BF-BOF route; nevertheless, complete replacement of coke is not possible because charcoal does not feature the same physical and chemical properties [22]. However, in most cases coal can be replaced by charcoal, and biomethane can completely replace natural gas in the different existing and innovative steel production technologies [20, 23]. As a result, if biomass is fully used in the BF-BOF, emissions can be reduced to around 0.69–1.21 t CO<sub>2</sub>/t steel; in the EAF, emissions can be reduced to around 0.028–0.056 t CO<sub>2</sub>/t steel; and in the DRI it is possible to reach emissions as low as 0.34–1.70 t CO<sub>2</sub>/t steel [24]. Currently, Brazil is the only country to use charcoal as a substitute for coal in the BF-BOF; 11% of the country's steel production uses charcoal instead of coal [25, 26]. However, the use of biogenic resources is restrained by local potentials [27]. Moreover, using only biomass in the ISI might not be enough to reduce the sector's emissions [26], and with current CO<sub>2</sub> prices biomass is not economically competitive [24], meaning that more efforts are needed to reduce the consumption of fossil fuels in the sector [28].

A further advantage that can be achieved when using biomass, is that it is possible to combine it with CCS/CCUS technologies (resp. BECCS and BECCU), which may produce negative emissions (NE). Indeed, as biomass is considered to be carbon neutral<sup>7</sup>, then by capturing and storing CO<sub>2</sub>, the

<sup>3</sup> A smelting process developed by Primetals, based on non-coking coal.

<sup>4</sup> ULCORED is one of the technologies researched by the ULCOS program (Ultra Low CO<sub>2</sub> Steelmaking).

<sup>5</sup> Electrowinning, which is developed by the ULCOS program, is a low-temperature electrolysis process that produces solid state elemental iron from iron ore.

<sup>6</sup> High-temperature molten oxide electrolysis steelmaking developed by the ULCOS program.

<sup>7</sup> When strict sustainable practices are followed.

latter can be subtracted from the atmosphere. BECCS/BECCUS are thus commonly referred to as Negative Emission Technologies (NETs). NETs can therefore help reduce emissions and mitigate residual emissions (process and remaining emissions from the use of some fossil fuels) [29]. In fact, in the long-term, negative emissions will most likely be required to reach global climate targets [30].

Therefore, although NETs appear to be a promising option to massively decarbonize the ISI, the different decarbonization options need to be rigorously assessed, carefully including the characteristics of each region in the world in order to obtain useful insights and propose strong, accurate policy instruments that can help attain climate objectives.

## 1.2. Literature review and contribution

### 1.2.1. Research into biomass as a replacement for fossil fuels in the ISI

Reducing emissions in the ISI proves to be a complex task due to the large array of options to reduce CO<sub>2</sub> emissions [1]. Decarbonization of the ISI will require disruptive innovations combined with CCS/CCU, enhanced material efficiency, a greater share of recycled steel production [15], and the substitution of fossil fuels with renewable energies and bioenergy coupled with CCS/CCU. **To date, and to our knowledge, no research have studied the role of NETs in the decarbonization of the steel sector [11], especially regarding their role in reducing emissions in a global, long-term context.** In most cases, biomass is not considered as an option to decarbonize the ISI, while most attention focuses on studying, for example, the role of the EAF or that of the DRI-H2 in future global steel production. [31] found that the share of the EAF in final global steel production might exceed that of the BF-BOF by 2060. Similarly, [32] found that the EAF might double its capacity by 2050. However, these studies did not include the use of biomass, which might have hindered the decarbonization potential of the EAF as biomass products can fully replace the fossil fuels used in this route [33]. For Europe, [34] studied long-term decarbonization scenarios for the ISI, finding that new innovative technologies are essential to decarbonize steel production. These technologies are mainly top gas recycle blast furnace (BF-BOF-TGR), as well as CCS in the ISI's electric power plants. At the country level, [35] mentioned that the DRI-H2 and the EAF seem to be the most prominent options to reduce some of the emissions from the Chinese steel industry. However, they state that to massively reduce these CO<sub>2</sub> emissions, NETs are required to offset the residual emissions. A similar finding was identified by [36], who also argue that negative emissions are needed to reach carbon neutrality for the Chinese steel industry.

Other studies include biomass products as a decarbonization option for the ISI, but not coupled with CCS. [37], through different climate scenarios, find that the BF-BOF coupled with CCS would have a significant role, followed by the deployment of the DRI-H2. On the contrary, in a world where CCS is not available, the BF-BOF using biomass would be the most cost-efficient technology, and the DRI-H2 would have a

more prominent position by 2100. On the International Energy Agency's steel technology roadmap [3], the use of biomass only was analyzed as a replacement for fossil fuels in the ISI, and they did not mention any pathways that included using biomass with CCS/CCU. In their results, biomass was hardly used in China and South America for BF-BOF, as these regions present interesting biomass potentials. In their analysis, decarbonization of the ISI is mainly achieved through energy improvements and materials efficiency, as well as the deployment of innovative steel production technologies. By 2050, the share of the BF-BOF could decrease to around 30%, and that of the scrap-based EAF to almost 40%. The rest of the production would be a combination of natural gas and H<sub>2</sub>-based DRI-EAF (DRI-H2), in combination with smelting reduction technologies coupled with CCS. Most gas-based DRI would be developed in the USA, South America, the Middle East, and Africa, while DRI-H2 would be developed in China, Europe, and India.

The deployment of biomass for steel production will be mainly limited by the availability of the resource on a territory. [27] assessed which countries have the potential to use domestic biomass resources in a sustainable manner for emission reduction purposes in the ISI. They found that China, Russia, the USA, and Brazil have high potentials for bioenergy use in BF-BOF. As these countries have a major role in world steel production, this suggests that widespread deployment of bioenergy in these few countries would make a significant step towards transitioning to the use of renewables in the global ISI [27]. Other countries with high biomass potential, but with a low share of global steel production, are Canada, Sweden, Australia, and France. The impact of deploying biomass in these countries might not be significant enough. However, the authors **did not consider the use of biomass in other sectors, nor the combination with CCS/CCU, or possible biomass trade between regions.**

**Research on the deployment of biomass to decarbonize the ISI has focus primarily on the national and regional levels.** It seems that simply substituting fossil fuels with biomass in the ISI might not be sufficient to significantly reduce emissions. [26] found that decarbonization of the Brazilian steel industry could reach a higher GHG reduction pathway by combining biomass use with the best available technologies. In Sweden, the use of biomethane to produce heat for the steel sector could reach 9% emissions substitution [38]. Furthermore, by utilizing biomass in existing steel production processes in Sweden, a reduction of up to 43% could be achieved [39]. At European level, similar CO<sub>2</sub> reductions of up to 42% could be achieved by substituting fossil fuels with biomass in existing steel producing facilities [40]. **None of these studies identified BECCS as an option.**

### 1.2.2. Studying the role of NETs to decarbonize the ISI

The use of biomass seems more attractive when coupled with CCS techniques. In fact, [41] showed that by deploying the DRI-EAF route in the Italian steel industry along with CCS, it might be possible to reach net negative CO<sub>2</sub> emissions. [17] mentioned that biomethane-based DRI-EAF combined with

CCS could be the most interesting option to reduce carbon emissions in the European steel industry. Furthermore, it would be possible to reach a 100% CO<sub>2</sub> reduction by deploying biomass with CCS in existing steel production facilities in Europe [42]. [43] found that a reduction of 80% in current CO<sub>2</sub> emissions could be expected by 2030 and an additional 3% reduction by 2045 in the Swedish steel sector when integrating biomass in the BF-BOF-TGR with CCS and in the EAF. In addition, they found that using the DRI-H<sub>2</sub> and the EAF as the main production routes would lead to almost fossil-free steel production by 2040. The use of hydrogen in this case would require 12 TWh of electricity, and the electricity would need to be carbon-free if the aim is to reduce global emissions [44]. Moreover, half way through this century, the DRI-H<sub>2</sub> and steel electrolysis could become economically attractive [45]. The use of these technologies might considerably impact the deployment of NETs within the ISI by the end of the century.

**On the other hand, to our knowledge, to date no research has assessed the implications of using biogenic CO<sub>2</sub> captured in the ISI to produce other materials.** In fact, it is possible to mix this captured CO<sub>2</sub> with steel slag to produce carbonates through a process called slag mineralization [46]. This route is one of the most reliable options to retain CO<sub>2</sub> in the long term as it prevents CO<sub>2</sub> leakage.

The use of NETs in the long run needs to be analyzed in a broader context considering the different decarbonization options in order to have a more complete vision about the possible implications that their development could entail. Indeed, **most research has mainly focused on one or a couple of decarbonization options (mainly EAF and DRI-H<sub>2</sub>; NETs are rarely considered) when studying the long-term decarbonization of the ISI. To our knowledge, no studies have analyzed the role of NETs in the long term on a global scale for the ISI.** Most research on the decarbonization of the ISI has focused on the Global North; however, the bulk of future demand for green steel will come from emerging and developing economies [47]. It is thus necessary to assess how the different decarbonization options can be deployed according to specific regional characteristics, and how NETs will position themselves in the decarbonization of the steel sector.

### 1.2.3. Considering other environmental aspects when deploying biomass

Other factors affecting the emissions from biomass should be considered to better assess its deployment potential. Most of the results found in the literature follow the hypothesis that biomass emissions are carbon neutral, but the CO<sub>2</sub> abatement potential of biomass is very sensitive to different factors, such as land use change (LUC). According to [48], life cycle analysis (LCA) cases indicate that nearly half the potential carbon mitigation of biomass use is negated by the carbon footprint of charcoal, with LUC being the main factor negating nearly all carbon abated. Another factor to keep in mind when dealing with the use of biomass is its rotation. This refers to the time that it takes to regrow the same amount of biomass so that the CO<sub>2</sub> emitted by its combustion is absorbed. [49] computed that

in a time horizon of 100 years, biomass taking 100 rotation years would have a global warming potential (GWP) impact of 0.44 kg CO<sub>2</sub> eq/kg CO<sub>2</sub> bio; and when considering its storage for 100 years, the GWP of this biomass would be -0.56 kg CO<sub>2</sub> eq/kg CO<sub>2</sub> instead of -1 kg CO<sub>2</sub> eq/CO<sub>2</sub>. This delay in the biomass carbon uptake was included in the research performed by [50]. They found that net CO<sub>2</sub> estimates for steel production using biomass would increase by around 300 kg CO<sub>2</sub> eq/t steel.

### 1.2.4. The contributions of this study

This research intends to propose a technology-rich assessment of the decarbonization of the ISI at the global level, considering mitigation pathways that have not been integrated in past studies, namely biomass combined with CCS and CCU on a global scale. Thus, through an energy prospective model (TIAM-FR - the French version of the TIMES Integrated Assessment Model), it is analyzed the potential contribution of NETs to decarbonizing the global ISI and in the long run. In addition, we assess how the steel sector can contribute to global climate goals. More precisely, our study contributes to the literature first by developing the TIAM-FR tool, and second by answering key questions regarding NETs deployment. The contributions of the present research are detailed as follows:

- Developing the TIAM-FR tool:
  - o Integrating current and prospective steel production technologies.
  - o Modeling the potential substitution of fossil fuels with biomass in different steel producing technologies.
  - o Restructuring the representation of biogenic and fossil CO<sub>2</sub> emissions to identify where and whether negative emissions are produced or not.
  - o Representing the mineralization of CO<sub>2</sub> as an option to store emissions in steel slag.
- Based on regional biomass potentials, and following different scenarios, the paper answers research questions related to the deployment of NETs for the ISI on a global scale. We intend in particular to address the following questions:
  - o To what extent could NETs in the ISI contribute to global climate targets?
  - o What would be the most cost-efficient technologies to decarbonize the ISI?
  - o How do NETs interact with other decarbonization options available for this sector?
  - o Depending on biomass potentials, which regions of the world are the most likely to rely on NETs? Would wood biomass be traded among regions?
  - o What are the implications for NETs deployment in the ISI when considering the rotation period of biomass?

Prospective modeling tools are decisive to help answer these questions, as they can provide responses to the various issues that emerge in the pursuit of sustainable, carbon-neutral energy solutions. Therefore, we employ the energy prospective model, TIAM-FR, to assess how NETs can contribute to the decarbonization of the ISI and to global climate objectives. The global ISI has been finely represented

in this model, along with the different decarbonization options for attaining carbon-free steel production. The model includes the option of slag mineralization, and finely details the possible substitution of fossil fuels with biomass in current and prospective steel production technologies. The modeling of biomass use in the ISI has been carried out in such a way that the model can choose the optimal amount of biomass to be used following technical replacement limitations. Furthermore, a particular feature has been developed to track the origin of the captured emissions (either fossil, biogenic or process emissions) in order to accurately identify the potential of each of the decarbonization alternatives. Finally, the interaction between biomass and the different decarbonization options, including the potential use of CCS/CCU are also considered in the model.

## 2. Methodology

### 2.1. Bottom-up modeling with TIAM-FR

The analysis of the ISI is carried out with TIAM-FR. TIAM-FR is a bottom-up global model that belongs to the TIMES family of models. TIMES is a generator of partial equilibrium techno-economic models representing the energy system of geographical areas or regions, on a long-term horizon. For each of the 15 regions in the model (see Appendix 1), present and future energy demands are fully satisfied by the energy produced within the region and trade with other regions. Thus, TIAM-FR is a bottom-up integrated assessment model (IAM). Its technology-rich representation depicts an

energy system tracking different energy forms, technologies, and end-uses (industry, commercial, residential, agricultural, transport), constituting the Reference Energy System (RES) (Figure 2). The technologies integrated into the model are characterized by the energy carriers and materials they consume, their technical (e.g. efficiency, activity factors, etc.) and economic characteristics (CAPEX, OPEX, etc.), the energy services they provide, and the GHGs they emit (CO<sub>2</sub>, CH<sub>4</sub>, and NO<sub>2</sub>).

The structure of the model enables us to consider variations across the 15 regions regarding their available technologies and their socio-economic properties (cost of capital, labor, and energy), energy demand projections, and their commercial routes. Driven by end-use demands, the model aims to supply energy services at a minimum discounted cost by choosing the most strategic investments to operate the energy system, while respecting the constraints established by the users, e.g. technical, and/or environmental. It computes the total net present value (NPV) by applying a discount factor  $d$  to the total annual cost of the system (Cost) in each region  $r \in R$  (*total number of regions*). The model solves the problem by minimizing the objective function in a linear program encoded in the GAMS optimization language according to the following objective function:

$$NPV = \sum_r \sum_y (1 + d_{r,y})^y \times Cost_{r,y}$$

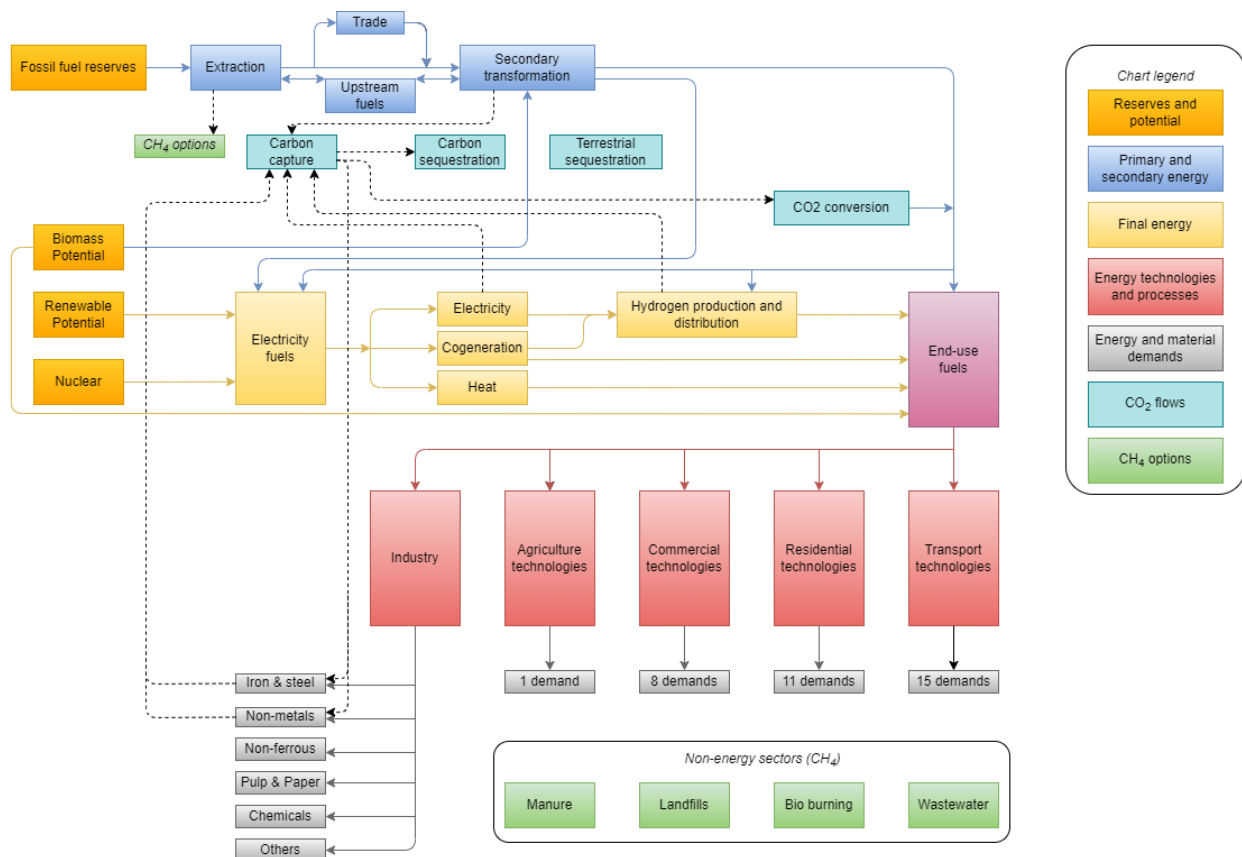

Figure 2: Simplified representation of the reference energy system (RES) in the TIAM-FR model

By satisfying the energy demands, decisions are thus made concerning the operation of the energy system over the defined period and for each region of the model. Specifically, the model produces two types of results when computing optimization. First, the primal solution of the linear program provides, for each period  $y$  and region  $r$ : technology investments, operation rates, the energy and material flows, the imports and exports of each tradeable commodity, the extraction levels of each primary resource, emissions by technology, by sector, and in total. Secondly, the model gives a dual solution, which provides the "shadow price" of each commodity of the RES (fuels, materials, energy services, emissions). Thus, information is available on the marginal costs of environmental measures such as GHG reduction targets, and in our case, we can track the marginal cost of steel production. In addition, the model is equipped with a climate module that can estimate the climate impact of emitting GHG, i.e. it calculates the impact on temperature elevation in the atmosphere. The interest of this type of modeling is the opportunity it provides to explore possible long-term energy pathways based on scenarios i.e., consistent assumptions on the trajectories of the determinants of the system. As a result, it is possible to propose strategies and policies for reaching the proposed objectives.

As mentioned before, TIAM-FR is divided into 15 regions (Appendix 1). These different regions of the world are linked together in terms of energy exchanges. The model has previously served to assess the long-term potential of bioenergy globally, and its results can be found for example in [51].

In this study, we improve the representation of iron and steel, as well as bioenergy supply to this sector. Thus, the modeling of the ISI (see Section 2.2) is built upon the latest

version of TIAM-FR, whose description is available in [52] – itself stemming from the ETSAP-TIAM model [53], and provides a rich representation of any forms of biofuels (solid, liquid, or gaseous). However, in this version, the use of bioenergy for the iron and steel sector is not exploited at its maximum level; biochar is not considered, and substitution of fossil fuels with biomass is lacking explicitness and opportunities. For these reasons, the following section details how the iron and steel sector is disaggregated in the new version of TIAM-FR, with richer description of the processes and wider opportunities for bioenergy to decarbonize this sector.

## 2.2. Steel decarbonization alternatives in TIAM-FR

The ISI is represented as one of the six subsectors of the industry sector, namely cement, chemistry, pulp and paper, aluminum, iron and steel and the rest of the industry. The energy consumption of the model's base year, i.e. 2018, is based on the energy balances of the steel industry from the IEA database [54]. The demand satisfied by the model is described in terms of tons of materials based on [4]. As a result, each region has a certain energy efficiency that converts the energy used into tons of steel, depending on the efficiency of the existing assets in 2018. Steel demand is projected over the 21st century based on the gross domestic product (GDP) per capita. Indeed, the quantity of steel produced by a country has been proven to be a function of this socio-economic driver [55, 56]. Regarding the projection of GDP per capita, these statistics are extracted from the IIASA SSP database [57]. The database enables us to calculate the elasticity of final energy demand of the industry to GDP per capita. Assuming an SSP2-2.6, the demand for steel is estimated to increase from 1.8 Mt in 2018 to 2.4 Mt in 2050 and decrease to 2.1 Mt in 2100

Process	Availability date	Fossil fuel use	Bioproduct substitution	Maximum substitution potential based on LHV	Reference
Coke oven	2018	Coal	Charcoal	0%-5%	(Mousa et al. 2016)
Pelletization	2018	Coal	Charcoal	0%-100%	(Nwachukwu, Wang et Wetterlund 2021)
Sintering	2018	Coke	Charcoal	0%-40%	
Blast Furnace / with CCS (including the Top Gas recycling option)	2018 / 2025	Coke	Charcoal	0%-6%	(Suopajarvi et al. 2017)
		Coal	Charcoal	0%-100%	
		Natural gas	Biomethane	0%-100%	
Direct Reduction of Iron (MIDREX) / with CCS	2018 / 2025	Natural gas	Biomethane	0%-100%	(Tanzer, Blok et Ramirez 2020)
COREX / with CCS	2020 /2025	Coal	Charcoal	0%-45%	(Norgate et al. 2012)
		Coke	Charcoal	0%-45%	
Hlsarna / with CCS	2030	Coal	Charcoal	0%-45%	(Tanzer, Blok et Ramirez 2020)
ULCORED / with CCS	2030	Coal	Charcoal	0%-100%	
		Natural gas	Biomethane	0%-100%	
ULCOWIN	2050	Natural gas	Biomethane	0%-100%	
		Coal	Charcoal	0%-100%	
Cupola	2018	Natural gas	Biomethane	0%-100%	(Yang, F., Meerman, J. C. et Faaij, A.P.C. 2021)
EAF	2018	Coal	Charcoal	0%-100%	
		Natural gas	Biomethane	0%-100%	
DRI-H2 integrated steel plant	2030	Coal	Charcoal	0%-100%	(Tanzer, Blok et Ramirez 2020)
		Natural gas	Biomethane	0%-100%	
Final production of steel	2018	Natural gas	Biomethane	0%-100%	

**Table 1:** Possible uses of biomass in the ISI in TIAM-FR. Substitution potentials based on LHV.



(Appendix 2). China is the largest producer of steel in 2018, representing 51% of the total steel production.

In this enhanced version of TIAM-FR, we represent the iron and steel sector explicitly, i.e., the various production routes are considered, while previous representation of the steel sector in TIMES was considered through final energy services for steam, machine drive, process heat, etc. [52]. Here, we model both conventional and alternative innovative technologies. Conventional technologies comprise the BF-BOF route, the DRI-EAF, and the EAF. Alternative technologies include the TGR BF-BOF, COREX, Hisarna, ULCORED, ULCOWIN, ULCOLYSIS, and the DRI-H<sub>2</sub> processes, which can be equipped with a carbon capture unit. A table containing the advantages and disadvantages of each technology is given in Appendix 3.

Retrofitting CCS options to existing technology portfolios is possible. It means that a CCS unit can be added to current existing steel production assets without needing to invest on a new steel production plant. Another option comprises retrofitting existing MIDREX technologies to allow the consumption of hydrogen. In TIMES modeling, all these processes are characterized by their economics [58–63], namely their CAPEX, variable and fixed OPEX, their lifetime, their discount rate, and their material and energy flows [58, 64, 59, 65], along with their GHG emissions. The different techno-economic assumptions for the current and alternative steel production technologies are detailed in Appendix 4.

In Figure 3, we give a simplified representation of our modeling exercise. This figure shows how energy, material and emission flows are considered. The various steel production processes (IIS\*) can consume different manufactured goods, i.e., sinter (MISSNT), pellets (MISPLT), etc.) and raw materials, i.e. lump iron ore (MISLORE), fine iron ore (MISFORE), scrap (MISSCR), and quick lime (MISQLI). Each steel manufacturing process features a dedicated so-called FuelTech (FT), processing various energies including gas, biogas, coal, coke,

oil, charcoal, electricity, and hydrogen. The FuelTech accounts for the combustion CO<sub>2</sub> emissions (IISCO2N). If the steel manufacturing process is equipped with CO<sub>2</sub> capture, then the FuelTech accounts for the quantity of combustion CO<sub>2</sub> captured (CPTCO2N), but the steel manufacturing process accounts for the captured process CO<sub>2</sub> emissions (CPTCO2P). Likewise, for biomass, the amount of biogenic CO<sub>2</sub> captured (CPTCO2B) is accounted for at the level of the FuelTech.

One important novelty of this work is that we have included new opportunities to use biomass for both conventional and alternative steel production routes. Table 1 presents a summary of the different potentials (found in the literature) to substitute fossil fuels with bioproducts for the different iron and steel technologies. In general, charcoal can substitute only a small share of the use of coke as it does not present the same physical and chemical characteristics. On the other hand, charcoal can substitute most of the coal (see the fifth column of Table 1), while biomethane is a perfect substitute for natural gas. Raw biomass cannot be used directly in any of these processes as it features high moisture content, volatile matter content, low calorific value, and low grindability, etc. [20]. Besides, biogas or syngas produced directly from anaerobic digestion and gasification cannot be used directly in the ISI as they do not present the same chemical composition as natural gas, and thus require purification and upgrading beforehand. The solver chooses the optimal amount of bioproducts to substitute fossil fuels (any combination from 0% to 100% of biomass is the steel energy mix).

Before 2030, charcoal is available only in Brazil, as around 11% of the country’s steel production uses charcoal instead of coal [25, 26, 66] and in Norway, which uses some charcoal in the steel industry. The use of bioproducts in the remaining regions is made possible starting from 2030. The harvesting potentials of the different bioproducts (wood, agriculture

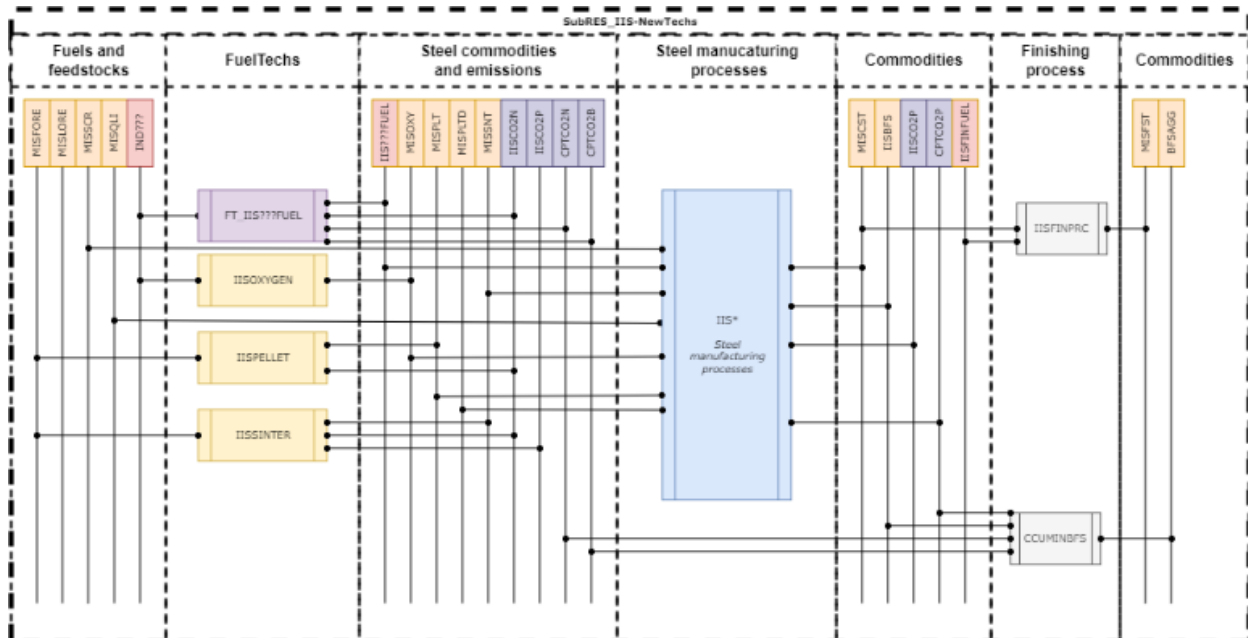

Figure 3: Simplified representation of the reference energy system (SRES) of the steel sector in TIAM-FR



industry. However, biomass trading between regions is allowed and may be substantial since some regions could lack biomass to generate sufficient negative emissions in the ISI. Similar assumptions to IISO are followed: developed regions have to achieve carbon neutrality by 2050 and developing regions by 2060.

5. *GWP from the use of biomass (IISB)* tackles the concerns expressed regarding the climate effectiveness of bioenergy in fighting climate change. We perform a sensitivity analysis of the decarbonization potential of the ISI by varying the carbon debt of bioenergy. Instead of considering that burning biomass emits zero emissions and that storing 1 ton of biogenic CO<sub>2</sub> generates 1 ton of negative emissions, we assign a GWP potential, based on the rotation period that it takes biomass to grow<sup>8</sup>, following [49]. Consequently, this scenario includes 2 variations (*IISB50* & *IISB100*) of the GWP of the used biomass, summarized in **Erreur ! Source du renvoi introuvable.** Another aim of these scenarios is to consider the effects on biomass deployment when taking into account other emissions associated with biomass use.

Rotation (years)	GWP (kg CO <sub>2</sub> eq/kg CO <sub>2</sub> )	Scenario
50	-0.8	IISB50
100	-0.56	IISB100

**Table 3:** Biogenic GWP factor values for specific rotation periods

6. For the sixth scenario (*IISBO*), due to sustainability and social acceptance constraints, biomass and CCS deployment for industrial activities might be limited. Thus, we set out to observe how steel production would evolve in a world where biomass is not available for the

steel sector coupled with a target of limiting the temperature rise to 1.5°C.

A brief description of the scenarios analyzed in the present study is given in Table 4. All the scenarios also feature some parametric constraints. First, the share of the EAF route in total steel production from 2050 has to be at least 50% of that presented in 2018, and can represent a maximum 50% of the total steel production for regions where scrap-based steel production has been poorly developed, and 60% in those regions that have a high share of the EAF in final steel production. Second, the share of the BF route (including CCS and top gas recycling) by 2050 is limited to 33% of the 2018 share in developing regions, and 25% in developed ones. After 2050, it is possible to stop using the BF route family. Third, the share of the DRI-EAF (including the CCS route) can represent a maximum 50% of the total steel output. Finally, the DRI-H2 route by 2050 can represent a maximum 30% of the steel production, but it is no longer constrained after that. These constraints are established with the purpose of integrating into the model the fact that the deployment of new technologies has to be progressive, as its adoption is limited by several institutional, behavioral, social, and economic factors [70]. The different constraints are linearized between periods. Finally, it is important to clarify that the only scenario where CO<sub>2</sub> emissions trading is not allowed is *IISR\_0*. In all the other scenarios, CO<sub>2</sub> emissions can be offset or compensated between regions.

Through the analysis of these scenarios, we will assess how the different decarbonization options are likely to interact with each other and with the rest of the energy system to reach decarbonization targets, and how NETs could contribute to tackling the current climate challenge. All scenarios are consistent with an SSP2, based on a recent post-COP26 study [71], which projects that demand for commercial steel will multiply by 2.5 by 2100.

Scenario	Objective
REF	Does not include any specific decarbonization plan for the ISI
2C	Limits the rise of global temperatures to 2°C, but no specific targets for the ISI
PA	Limits the rise of global temperatures to 1,5°C, but no specific targets to the steel sector
IISO	Limits the rise of global temperatures to 1,5°C, and the ISI has to be carbon neutral by 2050 for developed regions and by 2060 for developing ones. Regions can cooperate to reach the global objective
IISR_0	Limits the rise of global temperatures to 1,5°C, and the ISI has to be carbon neutral by 2050 for developed regions and by 2060 for developing ones. Regions cannot cooperate to reach the global objective
IISB50	Limits the rise of global temperatures to 1,5°C, and the ISI has to be carbon neutral by 2050 for developed regions and by 2060 for developing regions. Regions can cooperate to reach the global objective, and the efficiency of capturing CO <sub>2</sub> is reduced by 20%
IISB100	Limit the rise of global temperatures to 1,5°C, and the ISI has to be carbon neutral by 2050 for developed regions and by 2060 for developing regions. Regions can cooperate to reach the global objective, and the efficiency of capturing CO <sub>2</sub> is reduced by 44%
IISBO	Limit the rise of global temperatures to 1,5°C. No specific targets are applied for the ISI, and biomass cannot substitute fossil fuels in this sector

**Table 4:** Description of the scenarios analyzed in the present study.

<sup>8</sup> TIAM-FR includes a variety of biomass products derived from different agricultural and forest activities. The GWP factors would be applied to wood products only.

### 3. Results and discussion

#### 3.1. To what extent could NETs in the ISI contribute to global climate targets?

Figure 5 depicts the different net CO<sub>2</sub> trajectories (total direct CO<sub>2</sub> emissions *minus biogenic captured and effectively stored emissions in the ISI*) obtained by scenario. In the REF scenario, emissions show a convex pattern, increasing from around 2.8 Gt CO<sub>2</sub> in 2018 to 6 Gt CO<sub>2</sub> by 2050 and then decreasing to 5 Gt CO<sub>2</sub> by 2100. The emissions of this sector are shaped by final steel demand (which increases by 2050 and then decreases by the end of the century). The increase in emissions in the ISI and in the rest of the energy system would raise global temperatures to 2.4 °C by the end of the century.

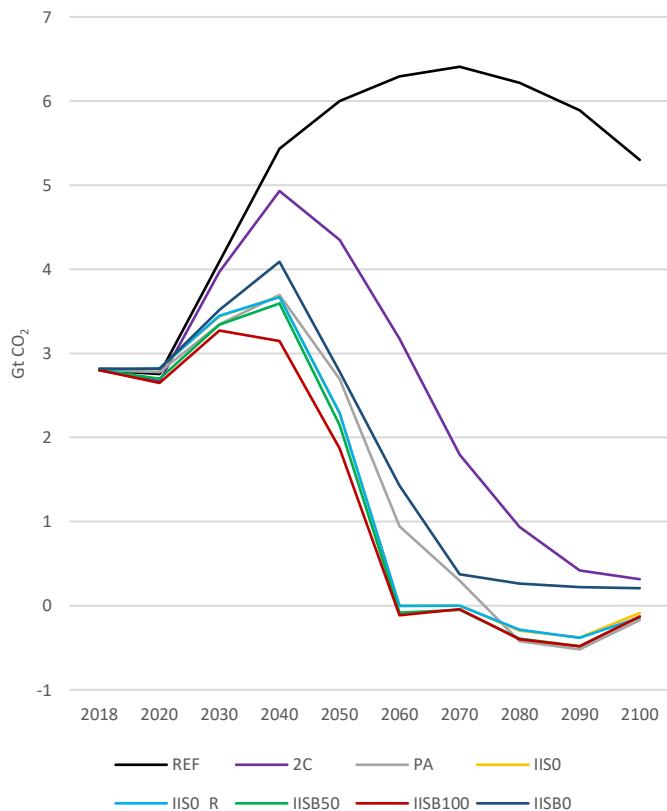

Figure 5: Net CO<sub>2</sub> emissions in the ISI by scenario

In the 2C scenario, emissions massively increase by 2040 (by almost 80%) but decrease thereafter to almost zero by 2100. In the scenarios limiting the temperature rise to 1.5°C (PA, IISO, IISO\_R, IISB50, IISB100), emissions increase by 2040, but significantly decrease by 2050, and the ISI becomes net negative thereafter. In the PA scenario, negative emissions are delayed: they are reached later in the century (mid 2070). This does not mean that NETs are not deployed early in the century; on the contrary, they are needed throughout the century to reach the decarbonization objectives. On the other hand, in IISB50, and IISB100, negative emissions are reached by the end of 2050 to compensate the additional emissions produced by biomass use. Then, the steel sector must engage on a deep decarbonization trajectory in order to limit the temperature

rise to 1.5°C and contribute to global decarbonization. The steel sector does not just decarbonize its production in these scenarios, it also contributes to the decarbonization of the rest of the energy system by becoming a net negative emitter.

Carbon capture with bioenergy starts being deployed by 2030 (some kt of bio-CO<sub>2</sub>) (see Figure 6). By 2050, the PA scenario captures the lowest amount of biogenic CO<sub>2</sub> at around 0.09 Gtpa but compensates for it later in the century. In the case where the ISI sets an objective of being a net zero emitter (IISO) by 2050, bio-CO<sub>2</sub> is captured at around 0.18 Gt. If each region aims at a similar objective without global cooperation, the reliance on biomass in the industry is slightly higher by 2050 (2%), but similar to IISO thereafter (on average 0.3 Gt of captured bio-CO<sub>2</sub>/year between 2060-20100). Higher emissions are required by 2050 to decarbonize those regions struggling to supply biomass to the ISI (see section 3.2). In addition, the ISI cannot reach zero emissions without capturing biogenic emissions, as it is not possible to compensate for the residual emissions coming from steel production processes. In the IISB0 scenario, it is observed that the ISI does not reach carbon neutrality, and the residual emissions of the ISI are compensated by negative emissions in other sectors. In this scenario, by 2050, CO<sub>2</sub> emissions reach similar levels as in 2018, and by 2100, emissions fall to 0.2 Gt CO<sub>2</sub>.

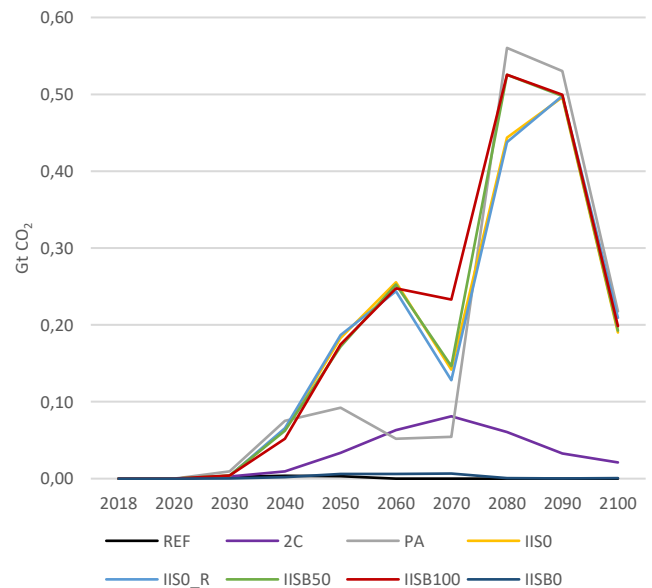

Figure 6: Captured and stored bio-CO<sub>2</sub> emissions by scenario

In IISB50 and IISB100, captured biogenic emissions reach an average rate of 0.30 Gtpa bio-CO<sub>2</sub> from 2050 to 2100 (25 Mtpa bio-CO<sub>2</sub> in PA, and 29 Mtpa of bio-CO<sub>2</sub> in IISO and IISO\_R). This shows that the high rotation growth period for biomass would require even greater biomass use to compensate for the additional emissions being produced. Therefore, using biomass in industrial processes might be conditioned by other sustainability factors that might affect the effectiveness of biogenic capturing processes (e.g. LUC). In this sense, higher biomass use for industrial activities might increase tensions over biogenic resources. Thus, sustainable practices must be followed and rigorously implemented to avoid collateral

damage to the environment, food production, human health, and the economy. In general, most of the efforts to capture biogenic CO<sub>2</sub> have been delayed to 2080-2090, where on average 500 Mtpa of bio-CO<sub>2</sub> is captured in the 1.5°C scenarios. By the end of the century, the capturing of bio-CO<sub>2</sub> in the steel sector decreases as other low carbon steel production solutions are deployed in the ISI (see section 3.3), and because steel demand decreases as well.

It is important to mention that this trajectory stems from an optimization process where the emissions reductions are the result of a global energy system that is cooperating to reach a common objective while limiting the rise of temperatures at minimum cost. Achieving global decarbonization cooperation is a challenging task, and so relying on late deployment of negative emissions in real life could be detrimental to attaining carbon neutrality by 2050. Indeed, negative emissions should be delivered today in addition to other emission reduction initiatives to ensure that the decarbonization of the economy is not delayed, and to avoid harmful effects on the climate. This statement is in line with [72] for example. Consequently, careful policy design is required to avoid negative emissions undermining other decarbonization efforts, e.g. changes in demand behavior.

Note that in all of the scenarios global carbon neutrality is not reached by 2050, and it is *de facto* attained by 2060 for

IISO, IISR\_0, IISB50, and IISB100. In PA, carbon neutrality is reached by the end of 2070. Targeting a net zero steel sector by 2050 might consume more energy and financial resources, and thus more structured, planned carbon neutrality by sector should be proposed. Finally, the deployment of net negative emissions in most of the 1.5°C scenarios is reached late in the century, which is comparable with [73] for example.

### 3.2. Depending on biomass potentials, which regions of the world are the most likely to rely on NETs?

Figure 7 shows the net CO<sub>2</sub> emission trajectories for selected regions, while all regional emissions are depicted in Appendix 5. In PA, China is the country that captures the most biogenic CO<sub>2</sub> between 2050 and 2100, representing on average around 35% of the total biogenic captured CO<sub>2</sub>/year (0.11 Gt of bio-CO<sub>2</sub>/year). India is the second largest producer of captured biogenic CO<sub>2</sub> emissions, representing on average 13% of the total biogenic captured CO<sub>2</sub>/year (30 Mtpa of bio-CO<sub>2</sub>). MEA is also a significant producer of biogenic CO<sub>2</sub> with an average of 21 Mtpa of bio-CO<sub>2</sub>. The USA and WEU deploy similar levels of biogenic captured CO<sub>2</sub> emissions per year at around 20 Mtpa of bio-CO<sub>2</sub> (7% of the total biogenic captured CO<sub>2</sub>/year). As shown in the previous section, biogenic captured CO<sub>2</sub> emissions decrease significantly by the end of the century. This can be explained by the fact that China has developed

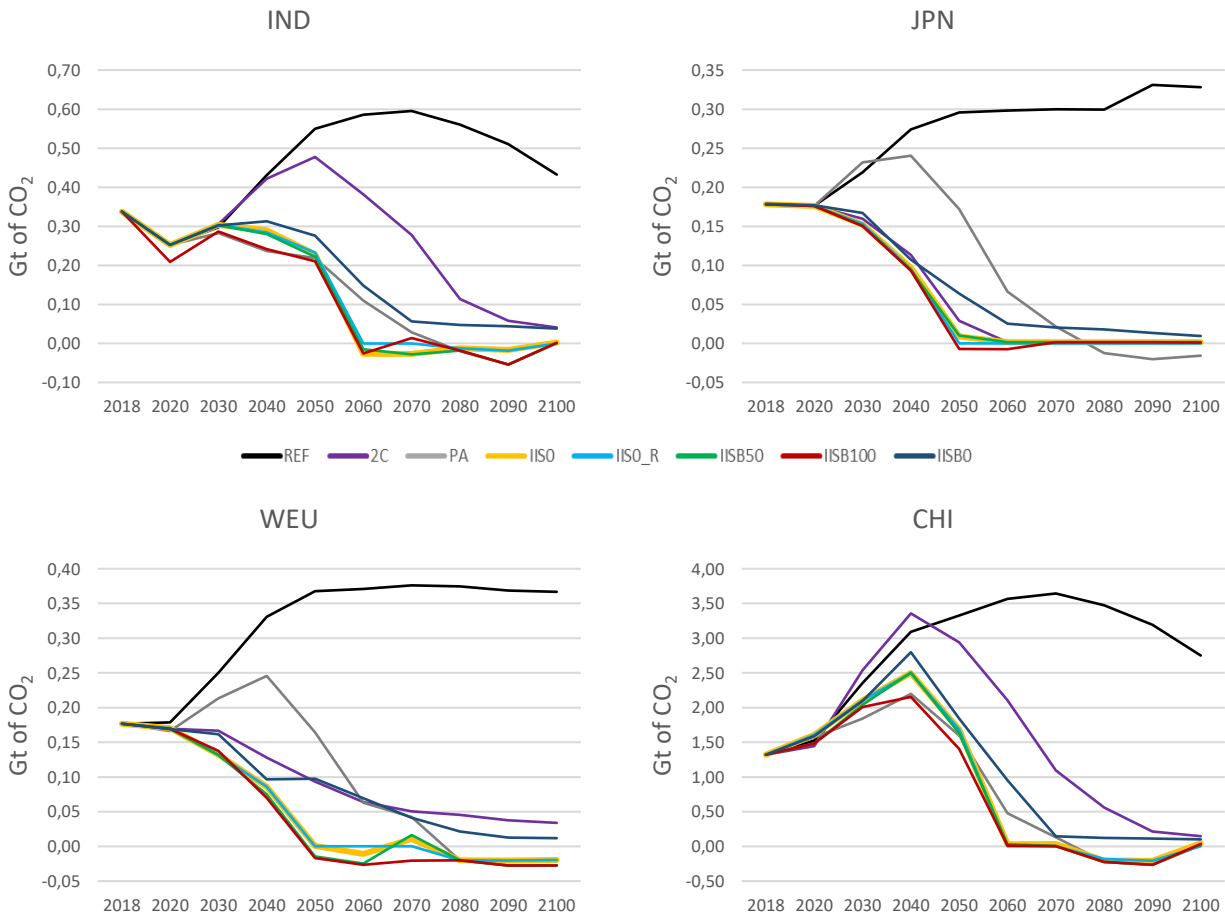

Figure 7: Net CO<sub>2</sub> emissions by scenario for selected regions

other low-carbon technologies to decarbonize its ISI throughout the period (EAF, ULCOLYSIS, etc., for more details see section 3.3.2.3.3.2), which reduces the need for NETs. In the *PA* scenario, Africa is the first region to reach net negative emissions by 2070, and by 2080 all regions become net negative.

In *IISO* by 2050, developed countries represent more than 70% of total captured biogenic CO<sub>2</sub> emissions, whereas they represented only 15% in *PA*. To reach carbon neutrality, the developed regions collaborate with each other. AUS, CAN, and USA reach negative emissions while the rest of the developed countries present residual ones. By 2060, WEU, ODA and IND have joined the regions producing negative emissions. Therefore, if the global ISI wants to reach carbon neutrality, the regions of the world will need to cooperate, mainly to compensate the residual emissions from developing countries, mostly Chinese. This country is still producing around 30 Mt of CO<sub>2</sub> (almost 50% of residual CO<sub>2</sub> emissions) in 2060.

In *IISO\_R*, to reach carbon neutrality by 2050, regions that still have residual emissions in *IISO* must increase the deployment of NETs, while those that have reached net negativity are reducing the amount of biogenic captured CO<sub>2</sub>. Specifically, JPN and SKO need to increase NETs deployment by around 50% with respect to *IISO*, producing 30 Mt and 20 Mt of bio-CO<sub>2</sub> respectively. However, JPN and SKO do not produce negative emissions, as the NETs deployed are only used to reach carbon neutrality in all periods and in all scenarios (except in *PA* where they become net negative by the end of the century).

In *IISB50* and *IISB100*, the additional emissions produced when using biomass hinder the capture of biogenic CO<sub>2</sub> in some regions, and favor it in others. CAN, SKO, and USA are the regions most affected by the additional emissions as they reduce the capture of biogenic CO<sub>2</sub> emissions by 26%, 16% (almost 100% in *IISB100*) and 14% respectively in the entire analyzed period. The regions that favor the deployment of NETs in *IISB50* and *IISB100* are ODA, and MEX showing a production of biogenic CO<sub>2</sub> emissions of 65%, and 35% respectively, higher than *IISO*. This can be explained by the fact that the latter regions present a lower biomass deployment cost than the former ones.

In summary, the most interesting region in which to deploy NETs is, first China, which is by far the greatest biomass user for the decarbonization of its ISI in all of the 1.5°C scenarios. This is not surprising, as China is the biggest producer of steel in the world. Despite remarkable levels of captured biogenic CO<sub>2</sub>, China only reaches carbon neutrality by 2060 in the *IISR\_0* scenario. After China come IND, WEU and the USA, which present interesting biomass potentials along with significant steel production capacities, allowing these regions to produce negative emissions. The deployment of NETs in the ISI is mostly driven by biomass potentials together with high steel capacity production. Therefore, international cooperation and solidarity between regions seems to be the most optimal trajectory to reach climate objectives. In fact, collaboration between the different regions of the world

would mean lower investments (see section 3.3.3.). Collaboration also avoids the use of biomass in regions like JPN and SKO that would struggle to supply their ISI with sustainable biomass products. By 2060 and beyond, the need for collaborating on the decarbonization of the ISI is higher as it is needed to compensate the emissions from the Chinese steel industry. *However, international collaboration entails establishing and further developing global CO<sub>2</sub> emissions trading systems to allow decarbonization of the global energy system. In addition, a framework to precisely account for negative emissions would need to be established globally. Although this might be possible, the main question here is: are the governments of the world willing to abandon their individualistic paths to collaborate for the common good?*

### **3.3. How can NETs help decarbonize the ISI and how do they interact with other decarbonization options?**

In the *REF* scenario, the BF-BOF route, i.e., featuring the conventional and most widespread technology, reduces its activity all over the world from 70% in 2018 to 38% in 2050 (Figure 8). The conventional route is replaced with more efficient technologies like the DRI-EAF and the COREX that run on cheap coal and generate gases used to generate electricity onsite. Therefore, this proves that, even with no climate constraints, the ISI is likely to transform its production routes to integrate available cost-efficient technologies. When constraining the global energy system to a 2°C climate target, the ISI deploys the DRI-EAF as a major route contributing to 22% of total steel output in 2050, while its counterpart with CCS is not deployed before 2070.

Regarding all 1.5°C pathways, CCS starts being deployed as of 2030, producing roughly 13% of global steel. Retrofitting BF with CCS acts as a transition technology representing almost 3% of steel capacities by 2030. BF-BOF assets without CCS reduce their share significantly by 2050. By the end of the century, the BF-BOF routes - with and without CCS – play no role. The EAF route also plays an important role in the decarbonization of the ISI in all scenarios. In the 1.5°C scenarios, by 2050, the EAF share of total steel output goes from an average 30% to almost 50% by 2060 and beyond.

Another technology that allows the decarbonization of the ISI is the ULCOLYSIS of steel which starts to be deployed by 2050 with a production of some Mt of steel (2% of total steel output in 1.5°C scenarios) (except for *PA*). By the end of the century its share increases to an average of 17% for *IISO*, *IISR\_0*, and *IISB50* (12% for *PA*). Its role is even greater by the end of the century when biomass is not available, as in *IISB0* its share increases to 25%. This is contrasted with the *IISB100* scenario, where this technology has been barely deployed, representing 5% of total steel output.

Most of the negative emissions reached in all the scenarios by mid-century are mostly obtained through the COREX process. By 2050-2060, in *PA* this process accounts for 22% of total production. This represents the highest share among the 1.5°C scenarios. By the end of the century, the share of the COREX significantly decreases to around almost

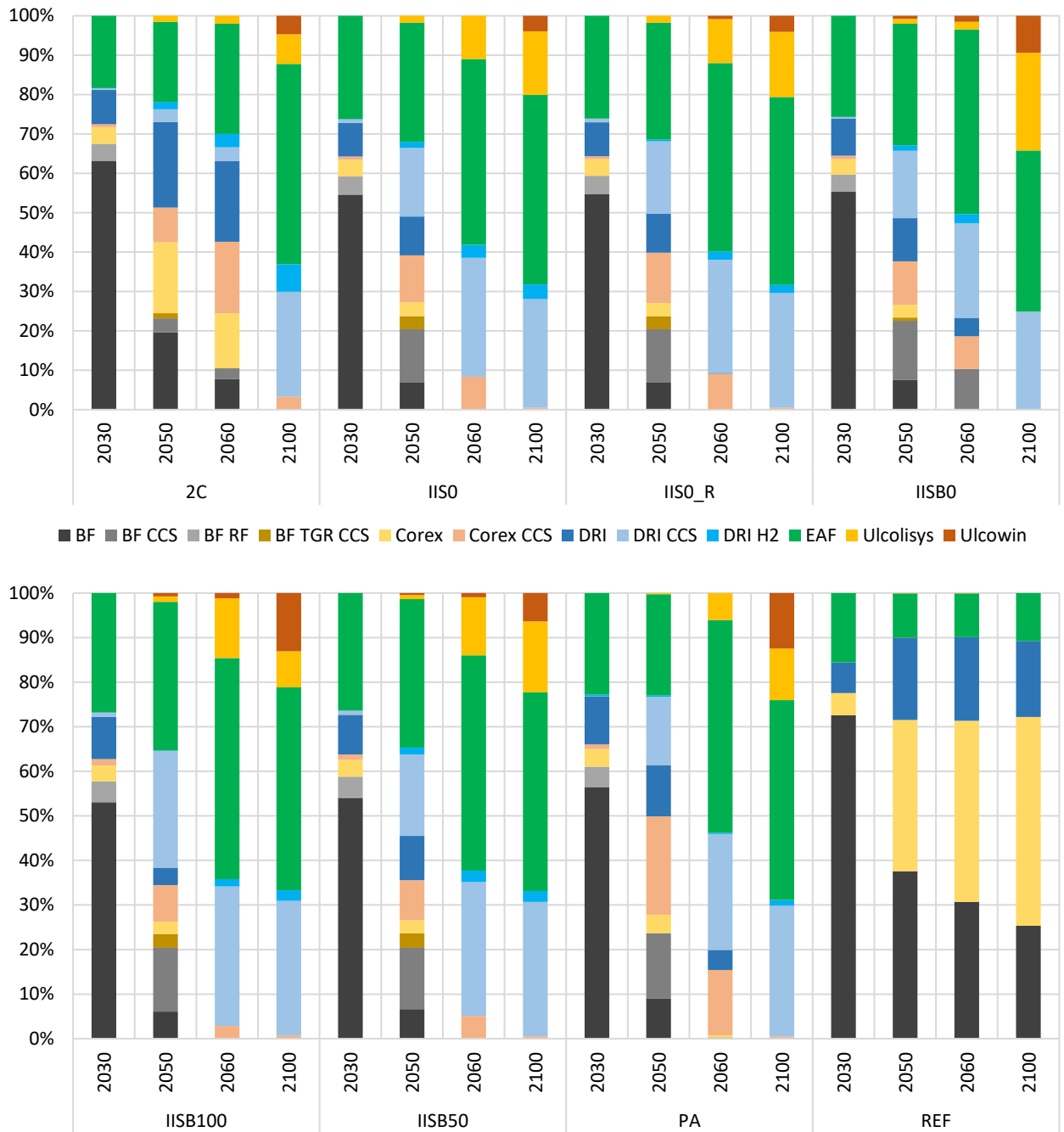

Figure 8: World steel production by technology and scenario

zero in all scenarios, as the DRI-EAF with CCS is heavily deployed to reach 30% of steel capacities.

In all scenarios, the DRI-H2 technology does not prove competitive. It reaches the highest rate of total steel output in *IISO* reaching 3% by 2050 and 4% by the end of the century. In *PA*, it is only deployed from 2100. This might be explained by the fact that it is needed to decarbonize the power sector to produce electricity used to produce hydrogen, and then used afterwards to produce steel. This appears to be a more complicated route than directly using electricity to produce steel through the electrolysis of iron. Moreover, note that by 2050-2060 iron electrolysis does not represent a significant share of steel production as NETs are needed to reduce the

concentration of CO<sub>2</sub> in the atmosphere. It is not possible to reach negative emissions through the DRI-H2, which reduces its decarbonization potential. However, if the electrolysis of iron is not ready by 2050, the DRI-H2 route might cover the role of the electrolysis route.

Following the above, in a world that is committed to limiting climate change, the COREX, the EAF and the DRI-EAF coupled with CCS appear to be the most efficient technologies to produce negative emissions. The high use of the COREX with CCS can be explained by the fact that this combination allows the recovery of some gases used to produce electricity, as well as negative emissions. The COREX acts as a transition technology as it is mostly developed by mid-century when it is

needed to produce negative emissions to decarbonize the whole energy system. This solution also relies on the detailed accounting of negative emissions that we have developed and integrated into TIAM-FR, so that the steel industry can compensate the residual emissions of the sector and contribute to the reduction of CO<sub>2</sub> emissions from the rest of the energy system. On the other hand, the DRI-EAF with CCS appears to be more attractive by the end of the century because by this period some biomass resources are available to produce biomethane (see section 3.3.1. for more details).

The results in this section, concerning the deployment of the COREX and EAF are similar to [55]. In fact, they analyze, through a simulation model, the long-term energy consumption, and emissions of the global steel sector under different scenarios. They find that when CCS is available, the COREX is one of the main technologies developed by 2050, while in the absence of CCS, the EAF would be the most deployed steel production process. Even though their results show that biomass represents around 40% of the total energy consumed in the ISI in CCS scenarios, they do not mention whether negative emissions are produced or not in the ISI.

Therefore, decarbonizing the ISI requires establishing synergy between the different steel decarbonization technologies. The main technologies accompanying the deployment of NETs are the recycling of steel scrap, and the electrolysis of iron. To this end, higher recovery of steel scrap might be possible with the establishment of adequate policies. Iron electrolysis would require the technology to be ready by 2050-2060, which might be possible. This technology would also require the existence of a carbon-free electricity sector, and low electricity prices, as it highly depends on this energy commodity. In the absence of the electrolysis of iron, DRI-H2 might be deployed technology.

### 3.3.1. What about energy use?

The deployment of negative emissions in the steel sector would entail an increase in the energy intensity of the industry by 2050, but a reduction thereafter. By 2050, in *PA*, the energy used to produce one unit of steel rises from 18 PJ/Mt of steel in 2018 to 21 PJ/Mt of steel (the highest among all the 1.5°C scenarios) in 2050, but it decreases to 13.1 PJ/Mt of steel by the end of the century (the lowest among the 1.5°C scenarios). In *IISO* and *IISR\_0*, energy intensity by 2050 is 19 PJ/Mt of steel and 14 PJ/Mt by the end of the period. In the *REF* scenario, energy intensity can increase to an average 24 PJ/Mt of steel in the period 2050-2100, and in a 2°C scenario, the energy required for one Mt of steel would be an average of 19 PJ in the same period. In this regard, the high energy intensity by 2050 is due to the use of the COREX process, which consumes high amounts of energy (28 PJ/Mt of steel), followed by a decrease in energy use by the end of the period as the ISI shifts to more efficient technologies like the ULCOLYSIS and the DRI.

To reach negative emissions in the different scenarios, solid biomass in the form of charcoal is mainly used between 2050-2060, while biomethane is developed towards the last

decades of the century (2070-2100) (see Figure 9). The highest share of charcoal in final energy consumption in the ISI is reached by 2060 (the year showing the highest deployment of charcoal) in *IISO*, and *IISR\_0*, representing around 21% of total final energy consumption of the steel sector. This would mean around 3.1 PJ/Mt of steel (105 kt of charcoal<sup>9</sup>/Mt of steel or an average of 1 PJ of charcoal/Mt of steel per year). In addition, in *IISB50* and *IISB100*, charcoal represents around 11% and 7% by 2060 respectively (the highest rate in the entire period), and an average 0.7 and 0.6 PJ of charcoal/Mt of steel per year. This shows the effect of considering additional emissions when using biomass. In *PA*, the highest share of charcoal in the ISI is reached towards the end of the century at around 6%, and on average 0.6 PJ of charcoal/Mt of steel is deployed per year.

Concerning biomethane, in *PA* its use starts by 2070, representing on average 3% of total energy consumption, and it increases to almost 17% by 2100. In the rest of the 1.5°C scenarios its deployment starts by 2050, representing around 2% of the total energy consumed, and its share increases significantly by the end of the century to around 16% of total energy inputs. The highest use of biomethane is reached in *IISB100*. By 2050, this energy represents 5% of total energy inputs, and on average it reaches a deployment of 2.7 PJ of biomethane/ Mt of steel per year (around 2% for the rest of the 1.5°C scenarios).

Biomass deployment in the ISI is a very versatile resource for decarbonizing the sector and has been widely used in the different decarbonization technologies. In the 1.5°C scenarios, charcoal reaches the maximum substitution rate of coke from 2050 and it mostly replaces coal in all periods in the COREX with CCS. However, in *PA*, high substitution rates of coal by charcoal are reached late in the century. Substitution rates of coal and coke by charcoal are also observed in the BF-BOF route in those periods where the technology is deployed, reaching maximum substitution potentials for the case of coke, and 30% for coal. In addition, maximum substitution rates are observed in pellet, coke and sinter production, 100%, 40% and 5% respectively.

In the DRI-EAF, by 2050 biomethane replaces natural gas at around 13% in *IISO*, and *IISR\_0*. Higher substitution shares are observed in *IISB50* and *IISB100* at around 20%. It reaches maximum substitution rates of natural gas between 2080-2090 in all scenarios. Biomethane is not just used in the DRI-EAF route, it is also used in the rest of the ISI, replacing natural gas used in the EAF and final steel production processes, and also reaching maximum substitution rates by 2080-2090. Finally, in the *REF* scenario, charcoal has some use in the BF-BOF, pellets, and sinter production, where it replaces coke and coal at maximum potential.

Biomass use within the ISI seems to be inevitable, as it will probably need to compensate residual process emissions produced by other low-carbon technologies (DRI processes (DRI-EAF, DRI-H2) or the EAF). Then NETs deployment serves to cope with these residual emissions, and it helps to decarbonize the rest of the energy system as well. In fact, the

<sup>9</sup> With an energy content of 30 MJ/kg for charcoal.



transport, supply, and agriculture sectors and the rest of the industrial sector do not attain net-zero in the analyzed scenarios. Reaching such carbon neutrality in each sector of the energy system might turn out to be more expensive than deploying NETs in industrial activities involving high concentrations of CO<sub>2</sub> that can be captured then stored. Finally, biomass use in the ISI is also possible, first, because biomass resources are relocated around the energy system, reducing its use in some sectors, thus allowing its higher use in others (e.g. steel industry). Second, because some agricultural biomass potentials increase.

### 3.3.2. How are technologies deployed by region?

China represents more than 50% of total steel demand in the whole period. IND, WEU, MEA and JPN, represent 7%, 6% and 5% (for MEA and JPN) respectively. Therefore, the following analysis will be developed mainly targeting these five regions as they represent almost 80% of total steel output throughout the analyzed period.

Figure 10 presents steel production by scenario for the three largest global steel producers. The rest of the production by region is plotted in Appendix 6. To decarbonize the steel industry by 2050 in PA, note that carbon capture and storage technologies are inevitable. On average, more than 50% of

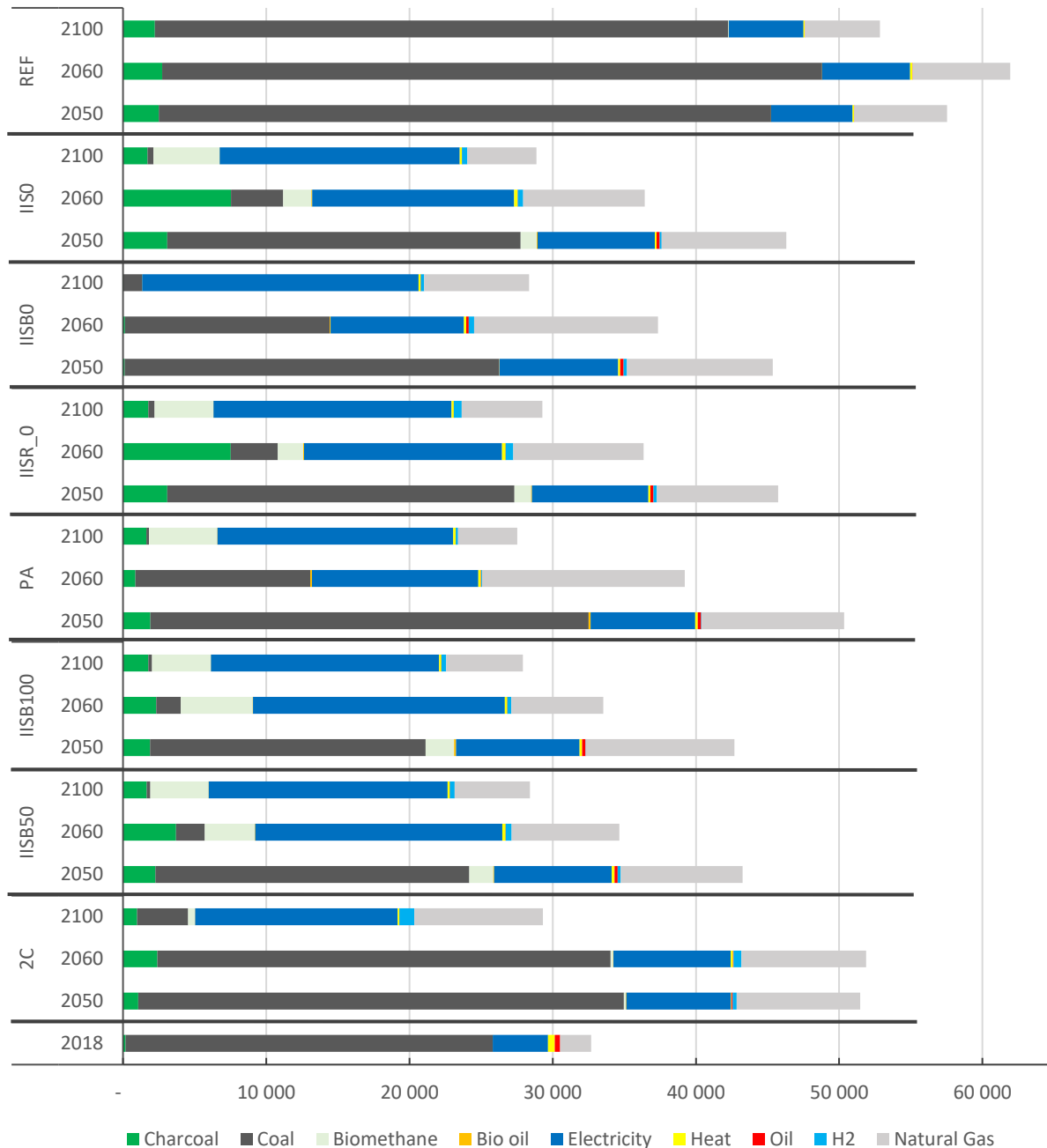

Figure 9: Energy consumption by scenario

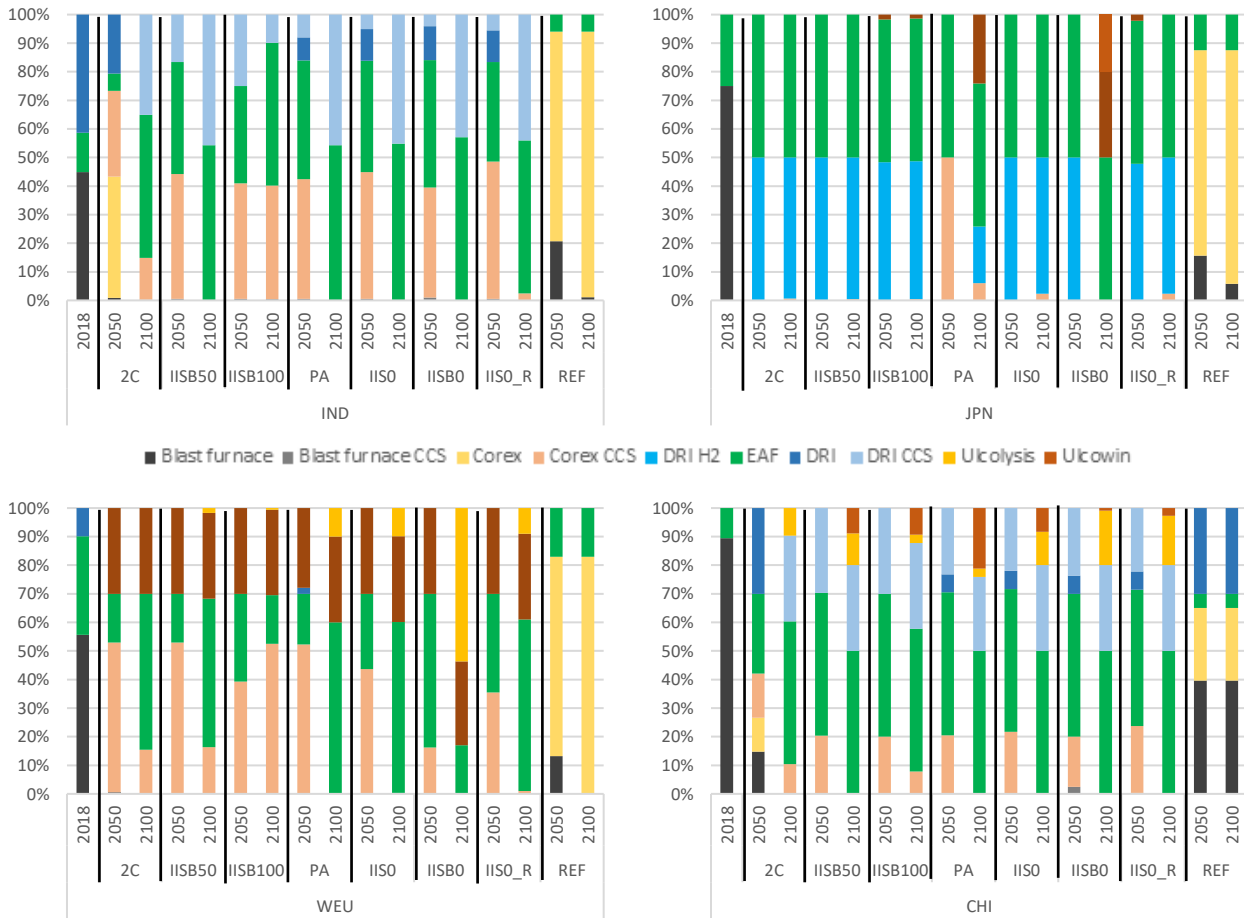

Figure 10 : Steel production technologies for selected regions and by scenario

steel production comes from CCS technologies (40% for IND and 13% for JPN). The BF-BOF with CCS is heavily developed in China representing 22% of the steel production of this country, and 8% in IND. In the rest of the targeted countries, the BF-BOF with CCS is not developed at all, however, its counterpart without CCS still accounts for a large share of steel production (24% for JNP, 18% for WEU, and just 5% for MEA). The COREX with CCS is another technology that contributes to decarbonizing the steel industry in these regions. It represents almost 30% of the steel production of IND, MEA and WEU, 17% in China and 13% in JPN. Similar results are observed in [55], where the COREX technology is mostly developed in China, India and Western Europe.

The DRI-EAF is mainly developed in IND, WEU and CHI, representing 25% and 14% of its total steel production respectively by 2050. In the rest of the regions, it is minimally developed representing 5% of the total production. In JPN, the DRI-EAF with or without CCS is not developed at all by 2050. The EAF is highly deployed in all countries and represents on average 50% of IND, CHI, and JPN production. For WEU this route represents 40% and 35% for MEA. The BF-BOF by the end of the century, in any of its forms, does not play any role in steel production, as its use stopped from 2070. In addition, all of the DRI-EAF has to also be coupled with CCS from 2070.

With respect to the ULCOLYSIS, this technology starts to be deployed from 2060 in CHI (9% of total production). This

contrast with the results found in [74] where the ULCOLYSIS starts being deployed from 2050 in China. By 2070 it is developed in IND and MEA (10% and 15% respectively). In WEU, the ULCOLYSIS is deployed by 2080 (10% of production). The DRI-H2 is developed in JPN from 2080, at around 20% of total production. Regarding the COREX (with and without CCS), its use declines completely towards the end of the century, being used only in JPN where it accounts for barely 3% of steel production. The negative emissions reached by JPN by the end of the century (see Figure ), are obtained from the DRI-EAF with CCS. Some other studies analyzing the decarbonization of the steel industry under different policies, show a higher development of the DRI-H2. For example [74], show that China, JPN, and SKO start developing the DRI-H2 from 2030. However, their study focuses only on these 3 regions and part of the hydrogen is imported, which does not allow to observe the whole system's emissions. Moreover, [35, 36] explore different pathways to decarbonize the steel industry and conclude that negative emissions are mandatory to decarbonize the Chinese steel production. Therefore, the role of the DRI-H2 might be reduced in a world that is committed to reaching full decarbonization.

In the cases where the ISI aims at carbon neutrality by 2050, i.e., IISO and IISR\_0, in CHI there is less COREX with CCS and higher use of the EAF at around 10%. In IND, the BF-BOF doubles its share of total production (15%), but DRI-EAF with

\$/t of steel	2020	2030	2040	2050	2060	2070	2080	2090	2100
2C	604	659	670	842	661	678	687	674	665
IISB50	610	681	712	960	721	733	669	609	608
IISB100	618	691	726	992	724	735	659	586	605
PA	599	648	660	724	724	745	662	628	667
IISO	603	673	701	895	716	735	680	589	632
IISB0	603	677	707	999	720	777	738	770	794
IISO_R	602	674	700	938	719	741	689	589	637
REF	597	576	553	557	539	547	550	550	548

*Table 4: Marginal cost of steel by year*

CCS almost triples (15% as well). On the other hand, JPN and WEU have completely stopped the BF-BOF route. To cover this production, JPN develops the BF-BOF TGR with CCS (24%), the DRI-EAF route with CCS (5%), and the DRI-H2 represents 21%.

The most significant differences between *IISO* and *IISR\_0* in terms of technological deployment are observed in JPN where the share of the DRI-EAF route with CCS increases to 17% of total steel output while the DRI-H2 decreases its share to 9% but increases thereafter to almost 50% from 2070 and beyond. For developing regions, by 2060, it is interesting to observe that in *IISR\_0*, as these regions cannot cooperate to reduce emissions, IND almost halves the use of the DRI-EAF with CCS, and mainly substitutes this production with the EAF route. The ULCOLYSIS of iron helps to decarbonize Chinese steel production and represents 15% of total output (67% more than PA).

In *IISB50*, by 2050, the COREX process with CCS shows significant reductions in its use, with respect to *IISO*, and *IISR\_0*, for CHI, IND and WEU, (-30%, -10% and -80% respectively). On the other hand, for MEA, the COREX process shows a moderate increase in its use (8%). In *IISB100*, the use of the COREX with CCS is reduced even more, at -50% for MEA and -23% for IND, and completely reduced for WEU. The technology that covers these reductions for IND, MEA, and WEU is the EAF, while CHI develops the ULCOLYSIS of iron even more, while JPN develops the DRI-H2. Moreover, from 2050 and 2060 (respectively for developed and developing regions) all steel production technologies are equipped with CCS (except for the EAF route and the ULCOLYSIS). Finally, by the end of the century, most production is covered by the DRI-EAF with CCS, the EAF, and the iron electrolysis.

In the absence of biomass for the ISI, the cheapest technologies equipped with CCS have been developed, producing the lowest emissions, as the residual emissions from the sector must be compensated by other sectors of the energy system. In fact, the DRI-H2 cannot completely decarbonize the steel sector, as some process emissions remain in the DRI-H2 due to the use of limestone and coal in the EAF<sup>10</sup>. Using DRI-H2 would produce slightly fewer emissions than the DRI-EAF with CCS (the emissions not being

captured by CCS) but at a much higher cost (without considering possible geopolitical conflicts that might affect natural gas prices). As a result, the iron electrolysis is developed the most, as there are no process emissions produced from this route, and because electricity can be used directly.

### **3.3.3. How would the deployment of the low-carbon transition in the steel industry impact its marginal cost of production?**

With all these developments, the marginal cost of steel would increase significantly when trying to reach climate targets (Table 4). By 2050, in 2C the marginal cost of steel will increase 42% (with respect to 2018 (600 \$/t of steel)), while for PA it rises by 21%. Reaching the steel sector net negative would imply a significant increase in the marginal cost of steel by 2050, at 49% in *IISO* and 56% in *IISR\_0* with respect to 2018. When considering different constraints for biomass deployment, in *IISB50* and *IISB100*, the marginal cost increases by 60% and 65% respectively with respect to 2018. This shows that considering adverse effects of biomass deployment, such as deforestation or LUC, can significantly impact steel production costs. Indeed, when considering a 50-year rotation for harvested wood biomass, higher biomass use is needed to compensate for the reduction in effectiveness due to its high rotation, which increases stress on biogenic resources. When the rotation period is higher (100 years), biomass use in the ISI is significantly reduced, and higher marginal costs for steel are observed. This can be explained by the fact that a GWP for using high rotation biomass has been applied to all of the sectors and not just the ISI, which means that the energy system has to rely on other more expensive technologies to decarbonize the energy system. This has an impact on the marginal cost of steel which increases significantly in *IISB100* and *IISB0*. Consequently, if other sustainability aspects when using biomass were to be analyzed, e.g. LUC, this route would have a significant impact on the deployment of NETs on a global scale. Therefore, strict guidelines on biomass use for NETs deployment should be applied, followed, and controlled in order to avoid any negative collateral effects when

<sup>10</sup> Coal and limestone have to be used in the EAF to foam slag, which serves to improve the performance of the furnace 7.

deploying NETs, assuring in this way **sustainable biomass** use. Moreover, in *IISBO*, shows the highest increase among all the scenarios by 2050, at 66% with respect to 2018. This shows that it might be worth developing biomass in the ISI.

The countries showing the highest cost for the decarbonization of the ISI are JPN and SKO as they have serious energy supply issues and need to develop expensive technologies to decarbonize their ISI. They present marginal prices higher than 1100 \$/Mt of steel. On the other hand, the regions showing the lowest marginal cost of steel are MEX, MEA, and the USA with an average marginal cost in the 1.5°C scenarios of \$650, \$660, and \$672 respectively by 2050. This could be explained by the fact that these countries rely on less expensive energy sources in general.

To further incentivize the global steel sector to decarbonize its activity, international cooperation is necessary. This would ensure that the value of fighting against climate change is shared among the different regions of the world. For example, if the ISI aims at a carbon free steel sector by 2050, a global carbon tax of approximately \$150/t of steel can be followed. This estimation takes into consideration that producing one ton of steel generates approximately 2 t of CO<sub>2</sub>/t of steel, and that one ton of steel in IISO costs almost \$300 more than today's steel price.

#### **3.4. Would wood biomass be traded among regions?**

The results of this paper show a future where biomass is largely used across the different scenarios to replace fossil fuels and to produce negative emissions. As a result, tensions over biomass resources are high and the regions of the world have developed their potentials as much as possible. However, some regions require biomass coming from other regions to supply their needs. Nonetheless, the quantity of biomass used in the steel sector is small compared to the rest of the energy system. On average, biomass use in the ISI among the different regions represents 1% to 3% of total biomass trade (biomass used to produce charcoal or biogas). Thus, biomass trade does not really play a major role in reaching climate objectives for the ISI. In fact, biomass trade increases the cost of steel, and as the global energy system is collaborating to maintain the temperature rise, the most interesting option involves deploying biomass locally and producing negative emissions that reduce emissions globally. In the case of MEA, biomass resources have to be reallocated. This means stopping biomass use for the residential sector, for example, and using it in industrial activities.

## **4. Conclusion**

This study contributes to the analysis of the development of Negative Emission Technologies (NETs) for decarbonizing the steel sector. The analysis was conducted using the TIAM-FR mathematical energy modeling tool. The study involved a literature review to identify the potential uses of biomass in existing and innovative steel-producing technologies, which were integrated into the modeling tool along with options for Carbon Capture Storage and Utilization (CCS/CCU). New

innovative steel-producing technologies were also identified and detailed within the model.

Through different scenarios this study contributes to the literature by answering key questions concerning NETs deployment:

1. *To what extent could NETs in the ISI contribute to global climate targets?*

The results indicate that the ISI must transition to become a net-negative emitter in order to make meaningful contributions to global climate objectives. Negative emissions are generated in the steel industry to compensate for the residual emissions of the sector and a portion of emissions from the broader energy system. In the PA scenario, the steel sector has achieved an average capture of 0.2 Gt of bio-CO<sub>2</sub> per year from 2030 to 2100. To reach this, it would be needed to use around 20 kt of charcoal per ton of steel. It is crucial to emphasize that effective policy design is essential to enable emission compensation across various sectors and prevent negative emissions from undermining other decarbonization efforts. Additionally, it is imperative to adopt and enforce sustainable practices rigorously to prevent adverse impacts on the environment, food production, human health, and the overall economy.

2. *What would be the most cost-efficient technologies to decarbonize the ISI? – How do NETs interact with other decarbonization options available for this sector?*

The primary technology enabling negative emissions production by mid-century is the COREX process, which offers significant potential for substituting coal with charcoal. It represents 22% of steel production capacities in 2050 in the PA scenario. The widespread deployment of this technology hinges on a substantial commitment from the global steel sector to massively implement negative emissions. Without such a commitment, the COREX process may not yield significant benefits for global decarbonization. Beyond 2060, the DRI-EAF with CCS allows the deployment of negative emissions in the ISI through the use of biomethane. It reaches almost 30% of world steel production capacities by 2070 in the PA scenario. Throughout the entire period, the EAF plays a crucial role in complementing the deployment of negative emissions technologies, while the iron electrolysis becomes increasingly significant for decarbonizing the ISI towards the end of the century. On the other hand, the H<sub>2</sub> route is less developed due to its high-cost implications for steel production, but its use could increase if iron electrolysis is not available by mid-century. The development of negative emissions technologies enables the steel industry to achieve lower marginal cost production compared to scenarios where biomass is not used, as other more expensive low-carbon technologies would be required to reduce emissions if not offset by negative emissions technologies. In the PA scenario marginal cost of steel could increase by 20%, and in the IISBO scenario, it increases by 70%.

3. *Depending on biomass potentials, which regions of the world are the most likely to rely on NETs? Would wood biomass be traded among regions?*

The deployment of negative emissions is closely tied to biomass potentials and high steel production. The regions that exhibit the highest deployment of negative emissions technologies are China, India, Western Europe (WEU), and the United States. The trade of biomass among regions is relatively limited.

4. *What are the implications for NETs deployment in the ISI when considering the rotation period of biomass?*

When considering a rotation period for biomass, higher biomass utilization would be necessary to compensate for the reduced effectiveness of negative emissions. With respect to the PA scenario, the utilization of charcoal is 36% higher in the IISB50 scenario and 8% higher in the IISB100 scenario. This highlights the importance of considering other sustainability factors when deploying biomass, as it significantly impacts its utilization in the steel sector and the broader energy industry. Reduced efficiency in achieving negative emissions would lead to higher costs for energy and materials overall. Therefore, stringent guidelines for biomass utilization in the deployment of negative emissions technologies must be implemented and monitored to avoid any negative collateral effects.

### Acknowledgments

This research is framed under the CarMa IFP School Chair entitled "Carbon Management and Negative CO<sub>2</sub> emissions technologies towards a low carbon future" <https://www.carma-chair.com/>. It is supported by TotalEnergies in association with Fondation Tuck as part of a postdoctoral program, and the Ministry of Higher Education and Research as part of a doctoral program (CIFRE). This work is also supported by the Modeling for Sustainable Development Chair, driven by Mines Paris and École des Ponts ParisTech, supported by ADEME, EDF, GRTgaz, RTE, SCHNEIDER ELECTRIC, TotalEnergies, and the French Ministry of Ecological Transition. The views expressed in the reports, or any public documents linked to the research program are attributable only to the authors in their personal capacity and not to the funders.

### References

- Carpenter A (2012) CO<sub>2</sub> abatement in the iron and steel industry
- Pee A de, Pinner D, Roelofsen O et al. (2018) Decarbonization of industrial sectors: the next frontier, McKinsey Co 2018;68.
- IEA (2020) Iron and Steel Technology Roadmap, IEA, Paris
- World Steel Association (2020) Steel statistical yearbook 2020 Extended Version. 46.
- Yang F, Meerman JC, Faaij A (2021) Carbon capture and biomass in industry: A techno-economic analysis and comparison of negative emission options. *Renewable and Sustainable Energy Reviews* 144:111028. <https://doi.org/10.1016/j.rser.2021.111028>
- Birat J (2010) Global Technology Roadmap for CCS in Industry
- Reichel T, Demus T, Echterhof T et al. (2014) Increasing the sustainability of the steel production in the electric arc furnace by substituting fossil coal with biochar
- Mohan Gosh A, Vasudevan N, Kumar S (2021) Energy-efficient technology options for direct reduction of iron process (Sponge iron plants)
- Remus R, Aguado-Monsonet MA, Roudier S et al. (2013) Best available techniques (BAT) reference document for iron and steel production: Industrial emissions Directive 2010/75/EU : integrated pollution prevention and control. Scientific and technical research series, vol 25521. Publications Office of the European Union, Luxembourg
- OECD (2015) Greening steel: innovation for climate change mitigation in the steel sector. Paris
- Yang F, Meerman H, Faaij A (2021) Harmonized comparison of virgin steel production using biomass with carbon capture and storage for negative emissions. *International Journal of Greenhouse Gas Control* 112:103519. <https://doi.org/10.1016/j.ijggc.2021.103519>
- Grosse F, Mainguy G (2010) Is recycling "part of the solution" :The role of recycling in an expanding society and a world of finite resources. S.A.P.I.EN.S 3
- MIDREX DRI Products & Applications - Providing Flexibility for Steelmaking. [https://www.midrex.com/wp-content/uploads/MIDrexDRI\\_ProductsBrochure\\_4-12-18-1.pdf](https://www.midrex.com/wp-content/uploads/MIDrexDRI_ProductsBrochure_4-12-18-1.pdf). Accessed 02 Aug 2022
- Bataille C (2020) Low and zero emissions in the steel and cement industries: Barriers, technologies and policies", OECD Green Growth Papers, No. 2020/02, OECD Publishing, Paris,
- Shatokha V (2016) Environmental sustainability of the iron and steel industry: towards reaching the climate goals. *EJSD* 5. <https://doi.org/10.14207/ejsd.2016.v5n4p289>
- OECD (2021) Steel Market Developments Q4 2021. Paris
- Patrizio P, Fajardy M, Bui M et al. (2021) CO<sub>2</sub> mitigation or removal: The optimal uses of biomass in energy system decarbonization. *iScience* 24:102765. <https://doi.org/10.1016/j.isci.2021.102765>
- Ho MT, Bustamante A, Wiley DE (2013) Comparison of CO<sub>2</sub> capture economics for iron and steel mills. *International Journal of Greenhouse Gas Control* 19:145–159. <https://doi.org/10.1016/j.ijggc.2013.08.003>
- Quader MA, Ahmed S, Ghazilla RAR et al. (2015) A comprehensive review on energy efficient CO<sub>2</sub> breakthrough technologies for sustainable green iron and steel manufacturing. *Renewable and Sustainable Energy Reviews* 50:594–614. <https://doi.org/10.1016/j.rser.2015.05.026>
- Mousa E, Wang C, Riesbeck J et al. (2016) Biomass applications in iron and steel industry: An overview of challenges and opportunities. *Renewable and Sustainable Energy Reviews* 65:1247–1266. <https://doi.org/10.1016/j.rser.2016.07.061>
- Ronsse F, Nachenius RW, Prins W (2015) Carbonization of Biomass. In: *Recent Advances in Thermo-Chemical Conversion of Biomass*. Elsevier, pp 293–324

22. Orre J, Ökvist LS, Bodén A et al. (2021) Understanding of Blast Furnace Performance with Biomass Introduction. *Minerals* 11:157. <https://doi.org/10.3390/min11020157>
23. Khanna R, Li K, Wang Z et al. (2019) Biochars in iron and steel industries. In: *Char and Carbon Materials Derived from Biomass*. Elsevier, pp 429–446
24. Norgate T, Langberg D (2009) Environmental and economic aspects of charcoal use in steelmaking. *ISIJ International* 49
25. Vakkilainen E, Kuparinen K, Heinimö J (2013) Large Industrial Users of Energy Biomass. IEA Bioenergy. Task 40: Sustainable International Bioenergy trade
26. Pinto RGD, Szklo AS, Rathmann R (2018) CO<sub>2</sub> emissions mitigation strategy in the Brazilian iron and steel sector—From structural to intensity effects. *Energy Policy* 114:380–393. <https://doi.org/10.1016/j.enpol.2017.11.040>
27. Mandova H, Gale WF, Williams A et al. (2018) Global assessment of biomass suitability for ironmaking – Opportunities for co-location of sustainable biomass, iron and steel production and supportive policies. *Sustainable Energy Technologies and Assessments* 27:23–39. <https://doi.org/10.1016/j.seta.2018.03.001>
28. Suopajarvi H, Pongrácz E, Fabritius T (2013) The potential of using biomass-based reducing agents in the blast furnace: A review of thermochemical conversion technologies and assessments related to sustainability. *Renewable and Sustainable Energy Reviews* 25:511–528. <https://doi.org/10.1016/j.rser.2013.05.005>
29. Material Economics (2019) *Industrial Transformation 2050: Pathways to Net-Zero Emissions from EU Heavy Industry*
30. Energy Transitions Commission (2018) *Mission Possible : Reaching net zero carbon emissions from harder-to-abate-sectors by mid-century*
31. Xylia M, Silveira S, Duerinck J et al. (2018) Weighing regional scrap availability in global pathways for steel production processes. *Energy Efficiency* 11:1135–1159. <https://doi.org/10.1007/s12053-017-9583-7>
32. C. Bataille, Stiebert, S. P.Eng, and Dr. Li, F. (2021) *Global facility level net-zero steel pathways: technical report on the first scenarios of the Net-zero Steel Projec. IDDRL*
33. Echterhof T, Pfeifer H (2011) Study on biochar usage in the electric arc furnace, 2nd International Conference on Clean Technologies in the Steel Industry, Budapest,
34. Pardo N, Moya JA (2013) Prospective scenarios on energy efficiency and CO<sub>2</sub> emissions in the European Iron & Steel industry. *Energy* 54:113–128. <https://doi.org/10.1016/j.energy.2013.03.015>
35. Zhang S, Yi B, Guo F et al. (2022) Exploring selected pathways to low and zero CO<sub>2</sub> emissions in China's iron and steel industry and their impacts on resources and energy. *Journal of Cleaner Production* 340:130813. <https://doi.org/10.1016/j.jclepro.2022.130813>
36. Wang X, Yu B, An R et al. (2022) An integrated analysis of China's iron and steel industry towards carbon neutrality. *Applied Energy* 322:119453. <https://doi.org/10.1016/j.apenergy.2022.119453>
37. Morfeldt J, Nijs W, Silveira S (2015) The impact of climate targets on future steel production – an analysis based on a global energy system model. *Journal of Cleaner Production* 103:469–482. <https://doi.org/10.1016/j.jclepro.2014.04.045>
38. Ahlström JM, Zetterholm J, Pettersson K et al. (2020) Economic potential for substitution of fossil fuels with liquefied biomethane in Swedish iron and steel industry – Synergy and competition with other sectors. *Energy Conversion and Management* 209:112641. <https://doi.org/10.1016/j.enconman.2020.112641>
39. Nwachukwu CM, Wang C, Wetterlund E (2021) Exploring the role of forest biomass in abating fossil CO<sub>2</sub> emissions in the iron and steel industry – The case of Sweden. *Applied Energy* 288:116558. <https://doi.org/10.1016/j.apenergy.2021.116558>
40. Mandova H, Leduc S, Wang C et al. (2018) Possibilities for CO<sub>2</sub> emission reduction using biomass in European integrated steel plants. *Biomass and Bioenergy* 115:231–243. <https://doi.org/10.1016/j.biombioe.2018.04.021>
41. Mapelli C, Dall'Osto G, Mombelli D et al. (2022) Future Scenarios for Reducing Emissions and Consumption in the Italian Steelmaking Industry. *steel research int* 93:2100631. <https://doi.org/10.1002/srin.202100631>
42. Mandova H, Patrizio P, Leduc S et al. (2019) Achieving carbon-neutral iron and steelmaking in Europe through the deployment of bioenergy with carbon capture and storage. *Journal of Cleaner Production* 218:118–129. <https://doi.org/10.1016/j.jclepro.2019.01.247>
43. Toktarova A, Karlsson I, Rootzén J et al. (2020) Pathways for Low-Carbon Transition of the Steel Industry—A Swedish Case Study. *Energies* 13:3840. <https://doi.org/10.3390/en13153840>
44. van Sluisveld MA, Boer HS de, Daioglou V et al. (2021) A race to zero - Assessing the position of heavy industry in a global net-zero CO<sub>2</sub> emissions context. *Energy and Climate Change* 2:100051. <https://doi.org/10.1016/j.egycc.2021.100051>
45. Fishedick M, Marzinkowski J, Winzer P et al. (2014) Techno-economic evaluation of innovative steel production technologies. *Journal of Cleaner Production* 84:563–580. <https://doi.org/10.1016/j.jclepro.2014.05.063>
46. Ostovari H, Sternberg A, Bardow A (2020) Rock 'n' use of CO<sub>2</sub> : carbon footprint of carbon capture and utilization by mineralization. *Sustainable Energy Fuels* 4:4482–4496. <https://doi.org/10.1039/D0SE00190B>
47. Hermwille L, Lechtenböhmer S, Åhman M et al. (2022) A climate club to decarbonize the global steel industry. *Nat Clim Chang*. <https://doi.org/10.1038/s41558-022-01383-9>
48. Fan Z, Friedmann SJ (2021) Low-carbon production of iron and steel: Technology options, economic assessment, and policy. *Joule* 5:829–862. <https://doi.org/10.1016/j.joule.2021.02.018>
49. Guest G, Cherubini F, Strømman AH (2013) Global Warming Potential of Carbon Dioxide Emissions from Biomass Stored in the Anthroposphere and Used for Bioenergy at End of Life. *Journal of Industrial Ecology*

- 17:20–30. <https://doi.org/10.1111/j.1530-9290.2012.00507.x>
50. Tanzer SE, Blok K, Ramírez A (2020) Can bioenergy with carbon capture and storage result in carbon negative steel? *International Journal of Greenhouse Gas Control* 100:103–104. <https://doi.org/10.1016/j.ijggc.2020.103104>
  51. Selosse S (2019) Bioenergy with carbon capture and storage: how carbon storage and biomass resources potentials can impact the development of the BECCS. In: Magalhães Pires JC, Da Gonçalves ALC (eds) *Bioenergy with carbon capture and storage: Using natural resources for sustainable development*. Academic Press, an imprint of Elsevier, London, San Diego, CA, Cambridge, MA, Oxford, pp 237–256
  52. Fais B, Sabio N, Strachan N (2016) The critical role of the industrial sector in reaching long-term emission reduction, energy efficiency and renewable targets. *Applied Energy* 162:699–712. <https://doi.org/10.1016/j.apenergy.2015.10.112>
  53. Loulou R, Labriet M (2008) ETSAP-TIAM: the TIMES integrated assessment model Part I: Model structure. *CMS* 5:7–40. <https://doi.org/10.1007/s10287-007-0046-z>
  54. IEA (2020) *World Energy Balances – Analysis*. <https://www.iea.org/reports/world-energy-balances-overview>
  55. van Ruijven BJ, van Vuuren DP, Boskaljon W et al. (2016) Long-term model-based projections of energy use and CO<sub>2</sub> emissions from the global steel and cement industries. *Resources, Conservation and Recycling* 112:15–36. <https://doi.org/10.1016/j.resconrec.2016.04.016>
  56. Neelis M, M.K Patel. (2006.) *Long-Term Production, Energy Use and CO<sub>2</sub> Emission Scenarios for the Worldwide Iron and Steel Industry*. UU CHEM NW&S (Copernicus)
  57. Riahi K, van Vuuren DP, Kriegler E et al. (2017) The Shared Socioeconomic Pathways and their energy, land use, and greenhouse gas emissions implications: An overview. *Global Environmental Change* 42:153–168. <https://doi.org/10.1016/j.gloenvcha.2016.05.009>
  58. ETSAP Energy Demand Technologies Data. <https://iea-etsap.org/index.php/energy-technology-data/energy-demand-technologies-data>. Accessed 02 Aug 2022
  59. Keys A, van Hout M, Daniëls B (2021) Decarbonisation options for the Dutch steel industry
  60. Kuramochi T, Ramírez A, Turkenburg W et al. (2012) Comparative assessment of CO<sub>2</sub> capture technologies for carbon-intensive industrial processes. *Progress in Energy and Combustion Science* 38:87–112. <https://doi.org/10.1016/j.pecs.2011.05.001>
  61. Vogl V, Åhman M, Nilsson LJ (2018) Assessment of hydrogen direct reduction for fossil-free steelmaking. *Journal of Cleaner Production* 203:736–745. <https://doi.org/10.1016/j.jclepro.2018.08.279>
  62. Wörtler M, Schuler F, Voigt N et al. (2013) Steel's Contribution to a Low-Carbon Europe 2050: Technical and Economic Analysis of the Sector's CO<sub>2</sub> Abatement Potential
  63. West K (2020) *LOW-TEMPERATURE ELECTROWINNING FOR STEELMAKING (ULCOWIN)*. [https://energy.nl/media/data/Ulcowin-Technology-Factsheet\\_080920.pdf](https://energy.nl/media/data/Ulcowin-Technology-Factsheet_080920.pdf)
  64. Griffin P, Hammond G, Norman J (2013) *Industrial Energy Use from a Bottom-Up Perspective Developing the Usable Energy Database (Beta Version)*.: UK Energy Research Centre (UKERC/WP/ED/2013/002)
  65. Sikström P (2013) ULCORED Direct Reduction Concept for ULCOS. A Brief Introduction. [https://ieaghg.org/docs/General\\_Docs/Iron%20and%20Steel%20%20Secured%20presentations/2\\_1430%20Peter%20Sikstrom.pdf](https://ieaghg.org/docs/General_Docs/Iron%20and%20Steel%20%20Secured%20presentations/2_1430%20Peter%20Sikstrom.pdf)
  66. SINDIFER (2020) *Produção de ferro-gusa em Minas Gerais e no Brasil. 2020 Anuário Estatístico. Ano base 2019*
  67. Kang S (2017) *La Place de La Bioénergie Dans Un Monde Sobre En Carbone : Analyse Prospective et Développement de La Filière Biomasse Dans Le Modèle TIAM-FR*. Ingénierie de l'environnement. PSL Research University, 2017. Français. NNT : 2017PSLEM081 . Tel-02096031
  68. IPCC (2023) *Emission factor database (EFDB)*. [https://www.ipcc-nggip.iges.or.jp/EFDB/find\\_ef.php](https://www.ipcc-nggip.iges.or.jp/EFDB/find_ef.php). Accessed 25 Feb 2023
  69. National Academies Press (US) *Negative Emissions Technologies and Reliable Sequestration: A Research Agenda*, Washington (DC)
  70. Iyer G, Hultman N, Eom J et al. (2015) Diffusion of low-carbon technologies and the feasibility of long-term climate targets. *Technological Forecasting and Social Change* 90:103–118. <https://doi.org/10.1016/j.techfore.2013.08.025>
  71. Climate Resource (2021) “1.9°C: New COP26 Pledges Bring Projected Warming to below 2°C for the First Time in History.” 4. <https://www.climate-resource.com/tools/ndcs>
  72. McLaren DP, Tyfield DP, Willis R et al. (2019) Beyond “Net-Zero”: A Case for Separate Targets for Emissions Reduction and Negative Emissions. *Front Clim* 1. <https://doi.org/10.3389/fclim.2019.00004>
  73. Rogelj J, Popp A, Calvin KV et al. (2018) Scenarios towards limiting global mean temperature increase below 1.5 °C. *Nature Clim Change* 8:325–332. <https://doi.org/10.1038/s41558-018-0091-3>
  74. Pim Vercoulen, Socheol Lee, Xu Han et al. *Carbon-Neutral Steel Production and Its Impact on the Economies of China, Japan, and Korea: A Simulation with E3ME-FTT:Steel*
  75. Lavelaine de Maubeuge H, van der Laan S, Hita A et al. *Iron production by electrochemical reduction of its oxide for high CO<sub>2</sub> mitigation (IERO)*
  76. Croezen H, Korteland M (2010) *Technological developments in Europe. A long-term view of CO<sub>2</sub> efficient manufacturing in the European region*
  77. Santos S (2013) *IEAGHG - Iron and Steel CCS Study (Techno-Economics Integrated Steel Mill)*

## Appendices

Appendix 1 : World regions represented into TIAM-FR

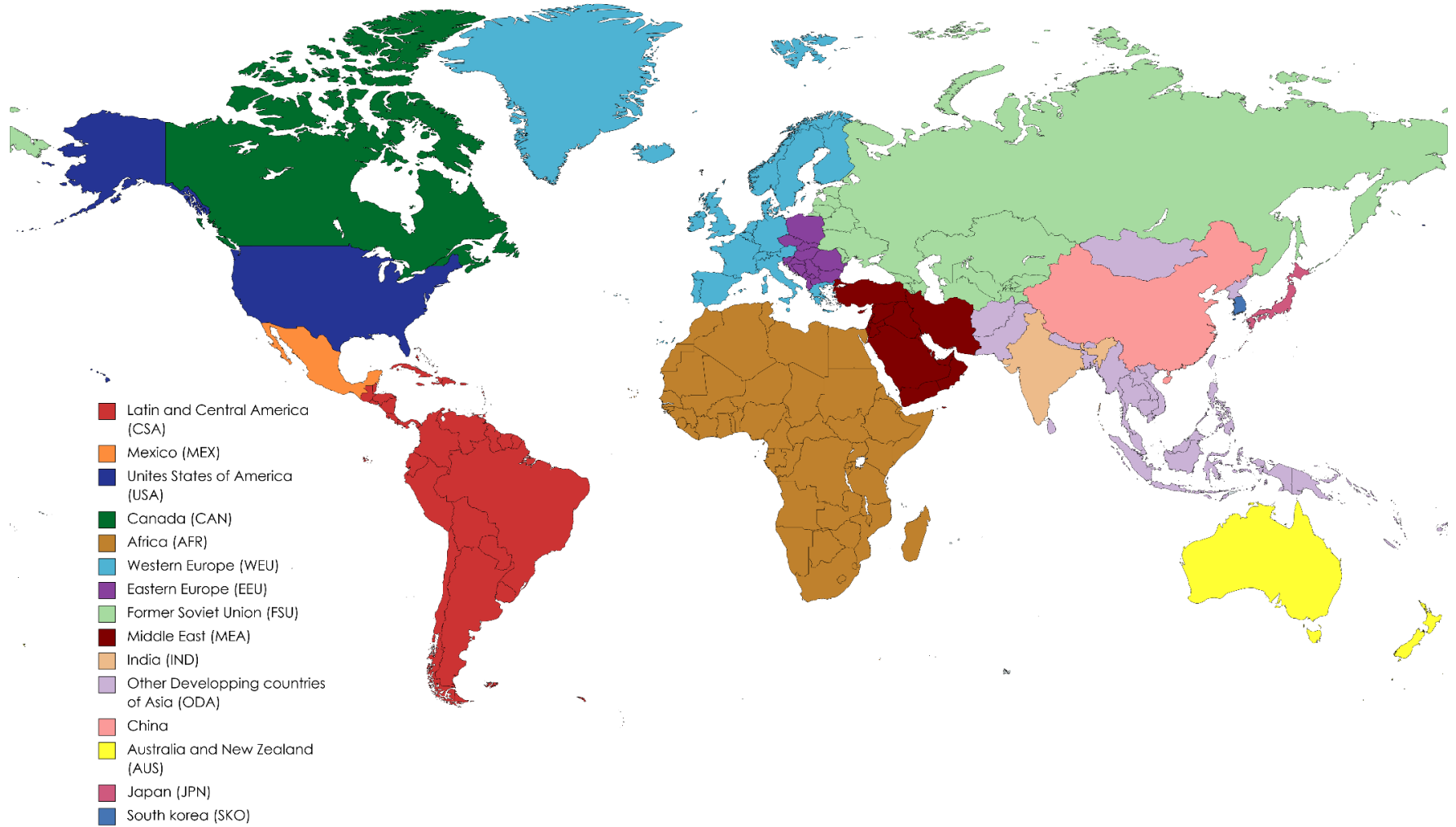



Appendix 2: Global steel demand projection following the SSP2-2.6

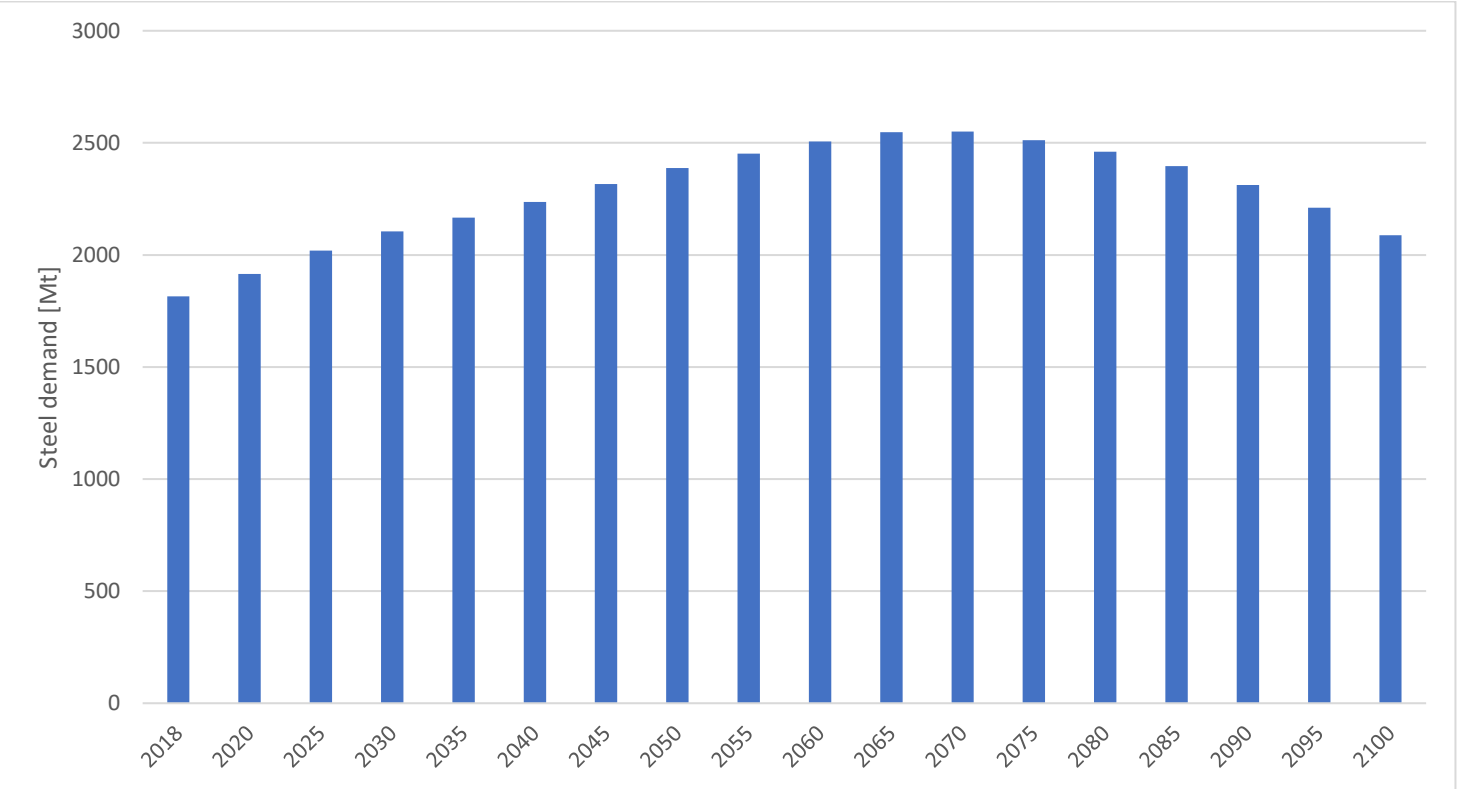

Appendix 3 : Advantages and disadvantages of each of the modeled steel production technologies

Steel production technologies	Advantages	Disadvantages
BF-BOF	<ul style="list-style-type: none"> <li>- Mature technology</li> <li>- Cost-efficient steel production process</li> <li>- Versatile technology in terms of energy and materials consumption</li> </ul>	<ul style="list-style-type: none"> <li>- Very polluting technology</li> <li>- Energy-intensive process</li> <li>- Hard to achieve further improvements in energy and material efficiency</li> </ul>
TGR BF-BOF	<ul style="list-style-type: none"> <li>- Higher energy and material efficiency</li> </ul>	<ul style="list-style-type: none"> <li>- Increased operational costs</li> </ul>
COREX	<ul style="list-style-type: none"> <li>- No need for coking and sintering</li> <li>- Possibility of directly using fine ore</li> </ul>	<ul style="list-style-type: none"> <li>- High energy intensive process</li> <li>- Large oxygen consumption</li> <li>- Coal based process</li> </ul>
DRI-EAF	<ul style="list-style-type: none"> <li>- Higher quality of final steel</li> <li>- Lower operational costs</li> <li>- Low-capacity plants</li> <li>- No need for sintering</li> </ul>	<ul style="list-style-type: none"> <li>- Higher initial investments</li> <li>- Low productivity</li> <li>- Sponge iron susceptible to oxidation</li> </ul>
DRI-H2	<ul style="list-style-type: none"> <li>- High energy efficiency</li> <li>- Low impurities of reduced iron</li> <li>- Reduced dependency on fossil fuels if hydrogen production is based on renewable energy</li> <li>- No need for coking and sintering</li> </ul>	<ul style="list-style-type: none"> <li>- High capital requirements</li> <li>- Need for special equipment and procedures to handle hydrogen</li> <li>- Sponge iron susceptible to oxidation</li> </ul>
EAF	<ul style="list-style-type: none"> <li>- High energy efficiency</li> <li>- Low capital investments</li> <li>- Safer than blast furnaces as no need to manipulate molten iron</li> <li>- No need for coking and sintering</li> </ul>	<ul style="list-style-type: none"> <li>- Low versatility in energy and material consumption</li> <li>- Dependency on scrap availability and quality</li> <li>- Requires regular maintenance</li> </ul>
Hisarna	<ul style="list-style-type: none"> <li>- High quality of iron</li> <li>- No need for coking, pelletizing, and sintering</li> </ul>	<ul style="list-style-type: none"> <li>- Complex process still under development</li> <li>- Scale-up challenge</li> </ul>
ULCOLYSIS	<ul style="list-style-type: none"> <li>- Very energy efficient technologies</li> <li>- No need for coking, pelletizing, and sintering</li> <li>- Possibility to produce carbon neutral steel</li> <li>- High reductions of air pollutants</li> </ul>	<ul style="list-style-type: none"> <li>- Still under development</li> <li>- Very inflexible process</li> <li>- Dependent on green electricity</li> </ul>
ULCOWIN	<ul style="list-style-type: none"> <li>- No need for coking, pelletizing, and sintering</li> </ul>	<ul style="list-style-type: none"> <li>- Still under development</li> <li>- Need for an EAF</li> <li>- Dependent on green electricity</li> <li>- Low productivity</li> </ul>
ULCORED	<ul style="list-style-type: none"> <li>- Easy to scale up</li> <li>- Reduced consumption of natural gas compared to the DRI-EAF</li> </ul>	<ul style="list-style-type: none"> <li>- Higher initial investments than the DRI-EAF</li> <li>- More expensive operational expenditures</li> </ul>

Appendix 4 : Techno-economic assumptions for the current and alternative steel production technologies based on [59, 11, 60, 75, 34, 76, 43, 63, 1, 19, 65, 45, 62, 77]

	Units	Existing BF-BOF	Retrofitted BF-BOF w/CC	New BF-BOF	BF-BOF w/CC	BF-BOF w/TGR	BF-BOF w/CC & TGR	Existing coke oven	New coke oven	Corex	Corex w/CC	CUPOLA	Existing DRI	Retrofitted DRI-H2	New DRI-H2	DRI-H2 w/Electrolyzer	Existing EAF	NewEAF	Finishing process	New finishing process	Hisarna	Hisarna w/CC	Midrex	Midrex w/CC	Retrofitted Midrex w/CC	Existing oxygen production	New oxygen production	Existing pellet production	New pellet production	Existing sinter production	New sinter production	Ulcocysis	Ulcored	Ulcored w/CC	Ulcowin			
Availability		85%	85%	85%	85%	85%	85%	95%	95%	85%	85%	90%	85%	85%	85%	85%	85%	90%	90%	90%	90%	85%	85%	85%	85%	85%	85%	85%	85%	85%	85%	85%	85%	85%	85%	85%	85%	
Lifetime	y	25	25	25	20	25	20		25	30	25	30	25	25	40	40	25	25	20	20	20	25	20	25	20	20	30	25	25	25	25	25	25	25	20	25		
Investment cost	[\$2018/Mtpa]	426	335	412	632	692		9	414	507	1126		437	587	989		240		195	918	961	510	531	462		353		126		71	775	593	658	731				
Fixed costs	[\$2018/Mtpa]	19	80	58	64	70	77		54	51	113	16	59	59	69	13	25	56	56	103	151	32	37	34	18	18	3	6	3	3	51	58	62	76				
Variable costs	[\$2018/Mt]	59	64	19	23	19	23	2	2	18	23	225	51	41	40	42	59	36	11	11	56	67	40	44	56		5	5	6	6		38	42	36				
Start year		2030	2020	2020	2030	2030		2020	2025	2025	2020		2030	2030	2030		2020		2020	2030	2030	2020	2030	2030		2020	2020	2020	2020	2050	2030	2030	2050					
Inputs	Coke or biochar	[PJ]	13.43	15.9	15.17	10.44	7.7	7.7	0.07	0.02	24.3	24.3															3.92	2.15	2.67	0.89								
	Coal or biochar	[PJ]				3.37	6.53	6.53	1.35	1.46	3.02	3.02																										
	Gas or biogas	[PJ]				0.51	0.25		0.16	0.14			11.4	13.85	0.77	0.77	1.41						16.17	12.79	12.79								10.91	11.41				
	Hydrogen	[PJ]												6.41	6.41																							
	Electricity	[PJ]				0.97	0.15	0.88		0.39	1.02	4.6	2.32	1.66	12.35	2.29	3.17	2.36							1.03	0.72					14.2	3.16	3.57	11.24				
	Heavy fuel oil	[PJ]				0.64	0																															
	Limestone	[Mt]	0.02	0.02	0.02	0.02	0.02			0.28	0.28			0.07	0.07	0.07	0.07	0.07					0.14	0.14	0.14						0.05	0.17	0.17	0.18				
	Lump ore	[Mt]	0.37	0.37	0.37	0.37				0.54	0.54											1.42	1.42	1.27	1.27	1.27					1.51	1.27	1.27	1.51				
	Fine ore	[Mt]	0	0	0	0	0	0	0	0.14	0.15	0	0	0	0	1.51											1	1	1.16	1.15								
	Oxygen	[Mt]	0.07	0.07	0.05	0.05	0.17	0.17		0.41	0.41				0.03	0	0.05	0.05				1.09	1.09												0.11	0.11		
	Pellets	[Mt]	0.09	0.09	0.09	0.09	0.72	0.72		0.68	0.68																											
	Quick lime	[Mt]	0.05	0.05	0.05	0.05				0.05	0.05											0.03	0.03															
	Scrap	[Mt]	0.18	0.18	0.18	0.18	0.17	0.17		0.18	0.18	1.3	0.16	0.12	0.12	0.12	1.23	1.23				0.17	0.17	0.16	0.16	0.16							0.16	0.16				
	Sinter	[Mt]	1.09	1.09	1.09	1.09	0.7	0.7																														
	Crude steel	[Mt]																		1	1																	
Outputs	Crude steel	[Mt]	1	1	1	1	1	1		1	1	1	1	1	1	1	1	1				1	1	1	1							1	1	1	1			
	Gases	[PJ]	5.09	4.11	4.11	4.11	0.25	0.25	0.16	0.14	11.55	0.65																										
	Slags	[Mt]	0.35	0.35	0.35	0.35	0.34	0.34		0.44	0.44		0.17	0.21	0.21	0.21	0.26	0.17				0.26	0.17	0.17	0.17													
	Process CO2	[kt]	44	44	32	3	11	1		144	14			31	31	31	44	44				14	1	62	6	6.16												
	Finished steel	[Mt]																																				
	Oxygen	[Mt]																								1	1											
	Pellets	[Mt]																										1	1									
	Coke	[PJ]						1	1																													
	Sinter	[Mt]																																				

Appendix 5: Net CO<sub>2</sub> emissions for each region and by scenario in Gt

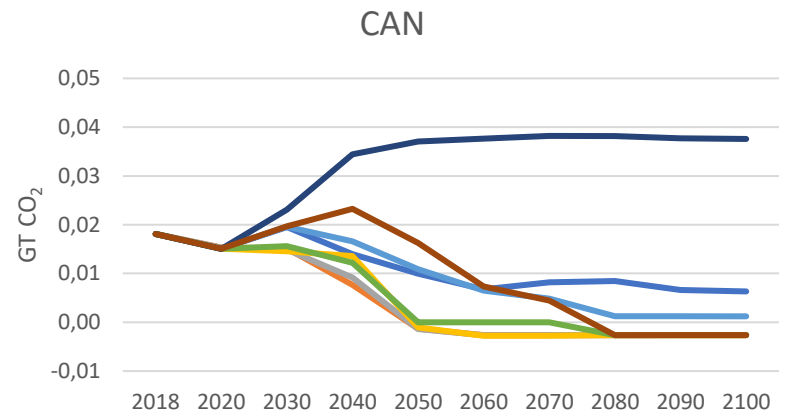
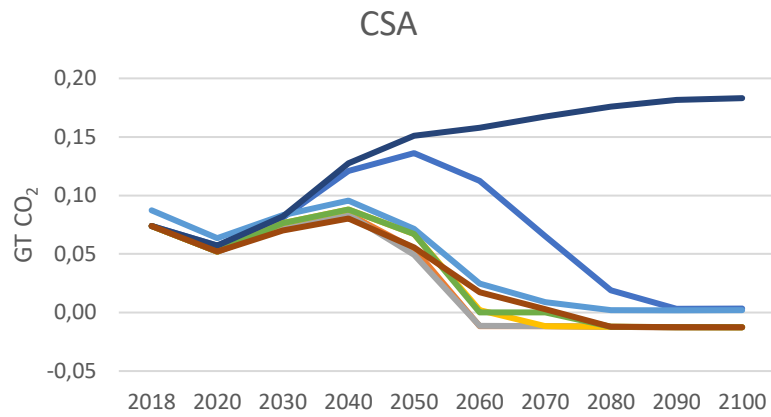
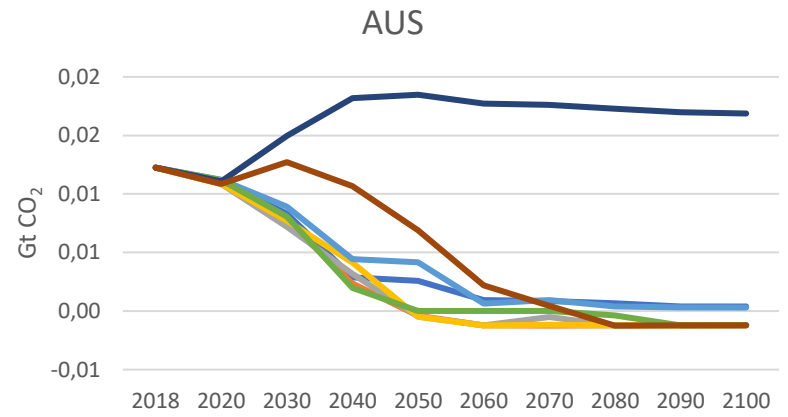
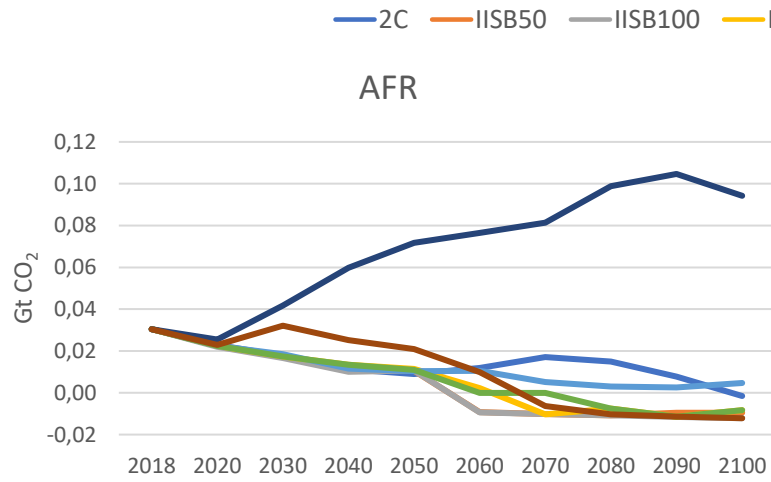

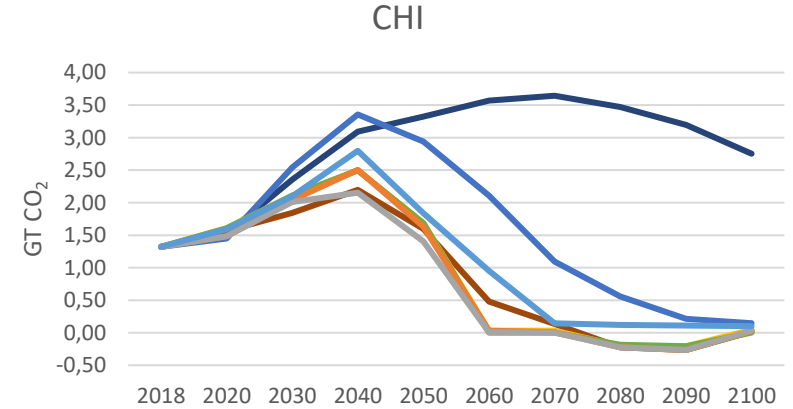
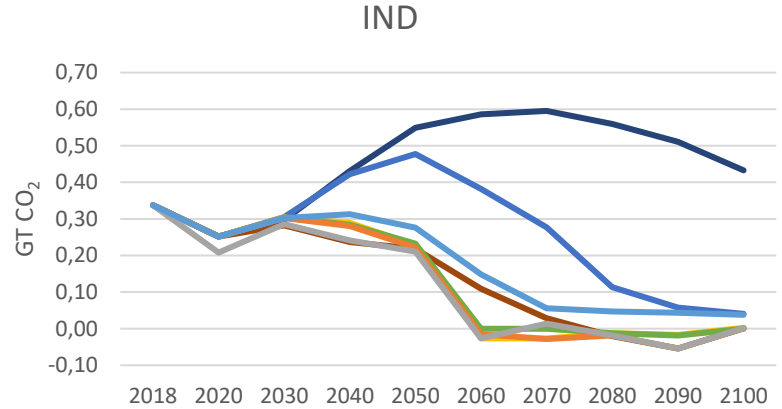
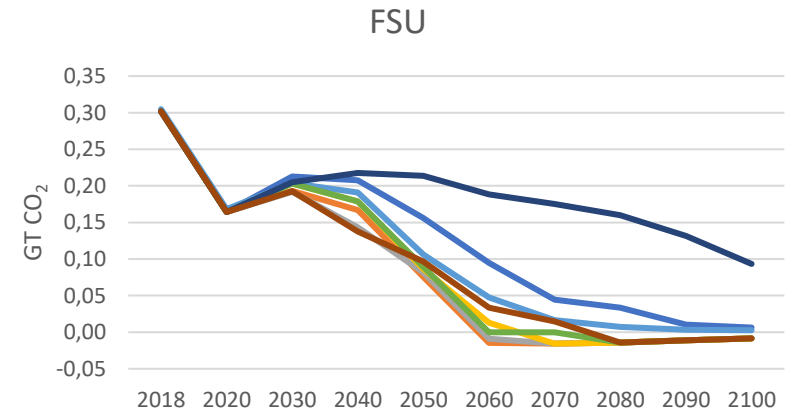
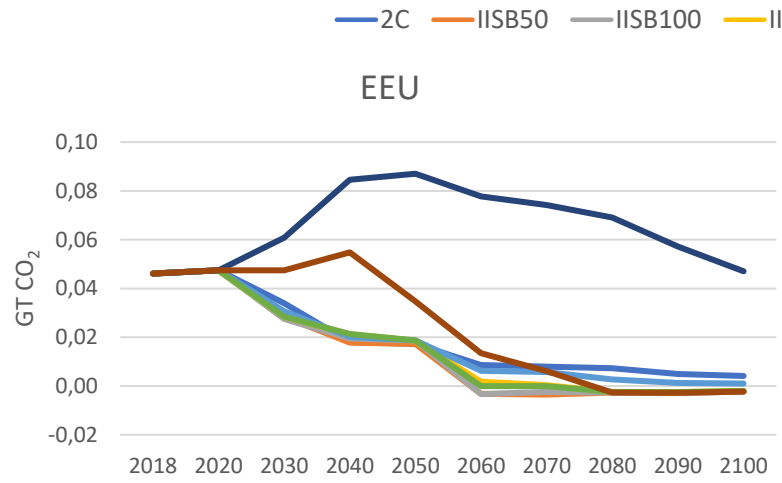

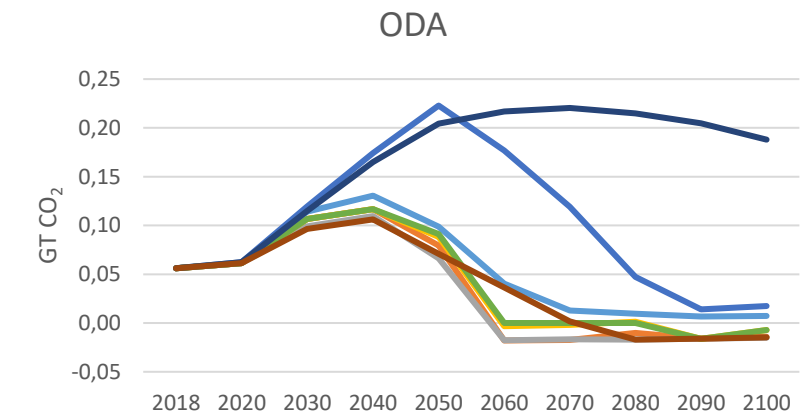
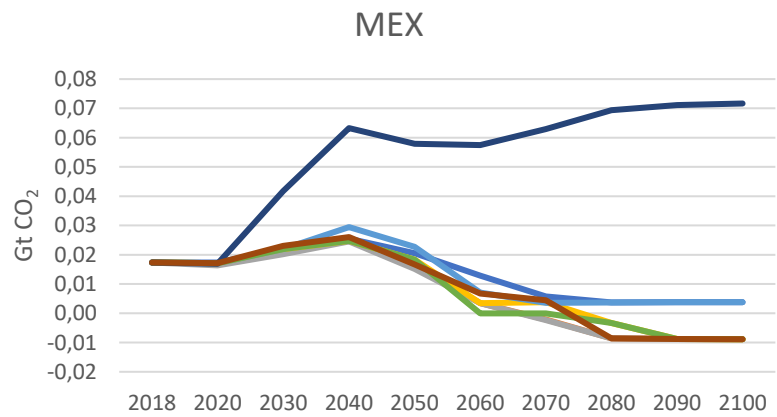
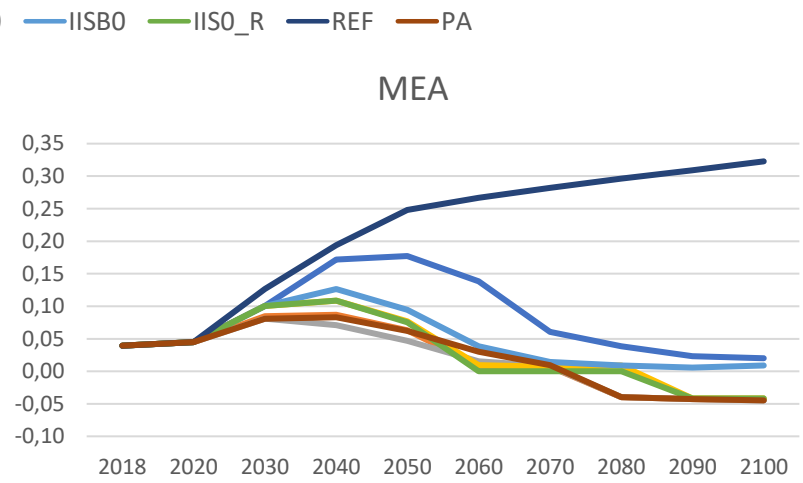
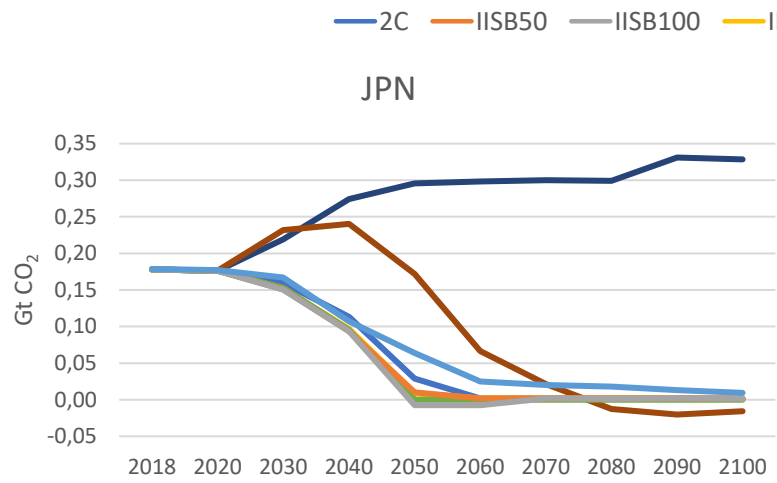

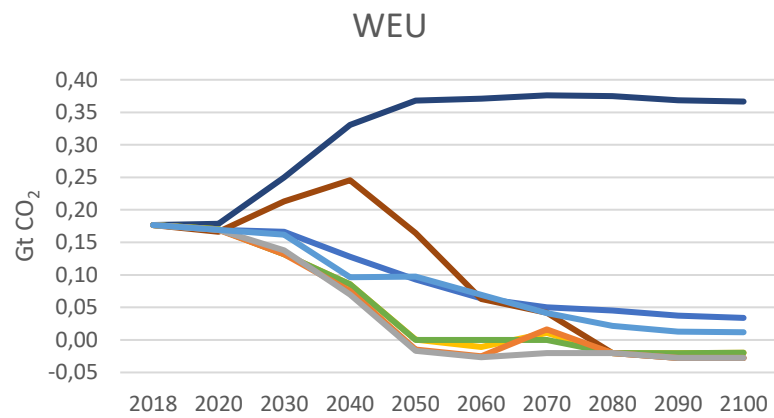
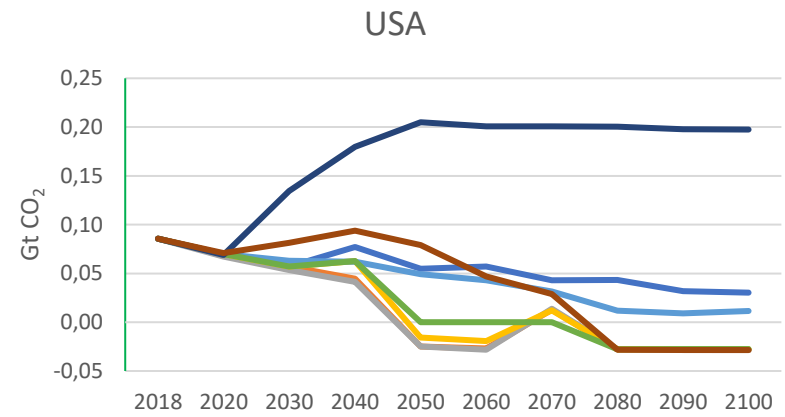
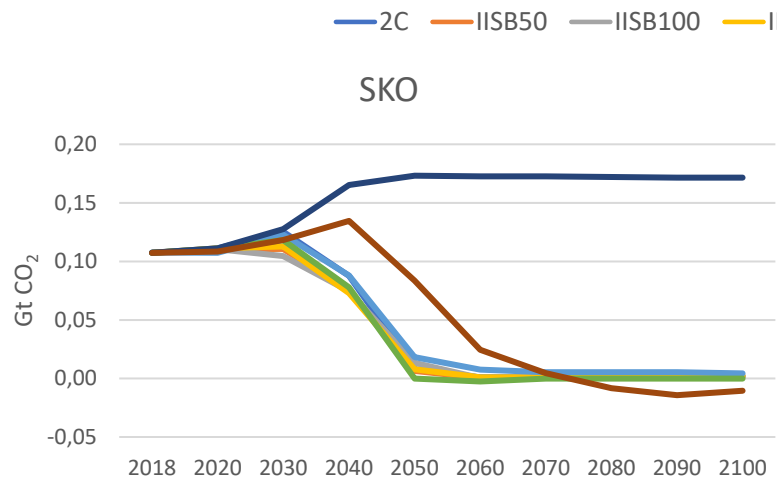

Appendix 6: Steel production technologies by region and scenario

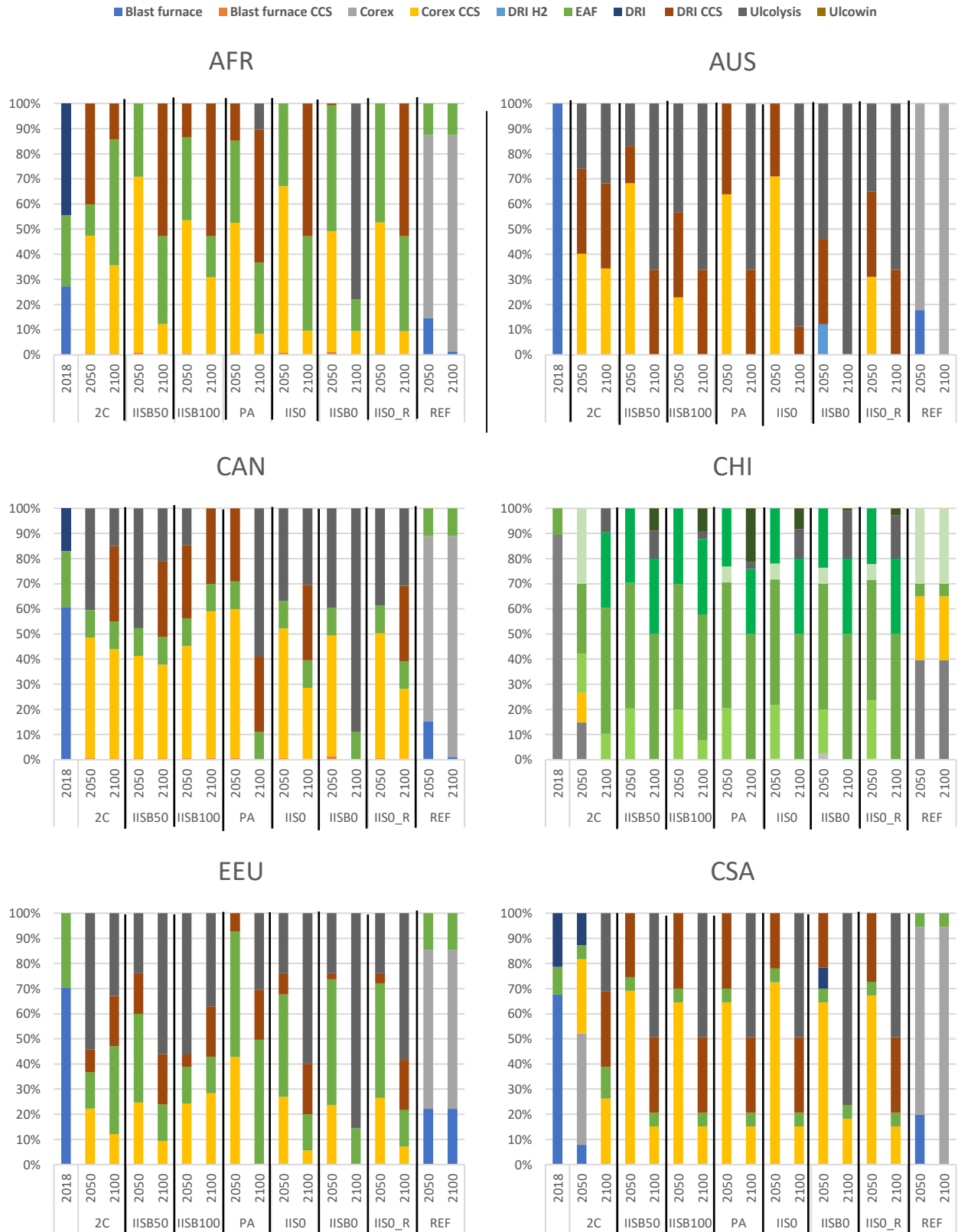



■ Blast furnace  
 ■ Blast furnace CCS  
 ■ Corex  
 ■ Corex CCS  
 ■ DRI H2  
 ■ EAF  
 ■ DRI  
 ■ DRI CCS  
 ■ Ulcolysis  
 ■ Ulcowin

### FSU

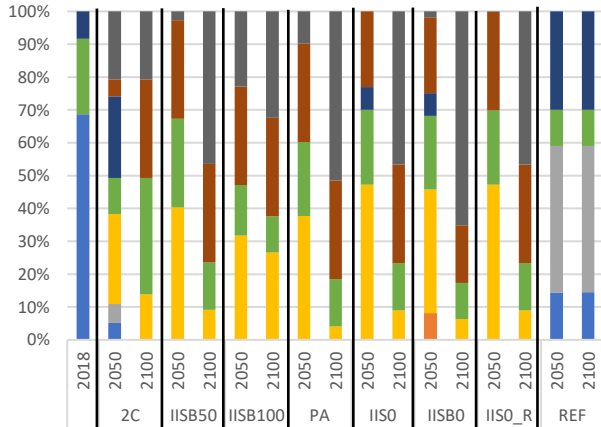

### IND

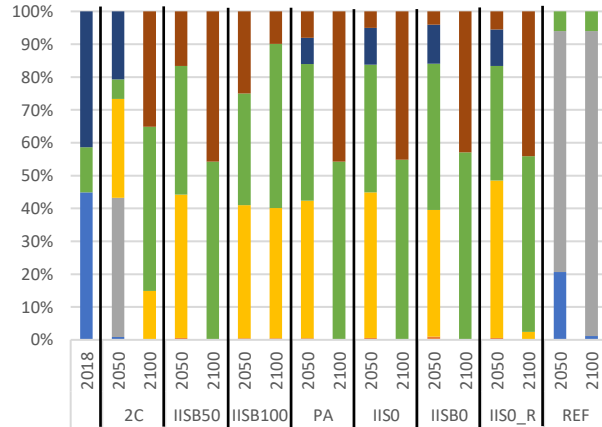

### JPN

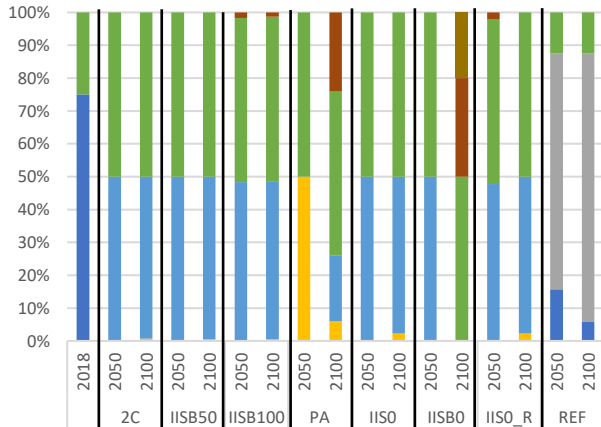

### MEA

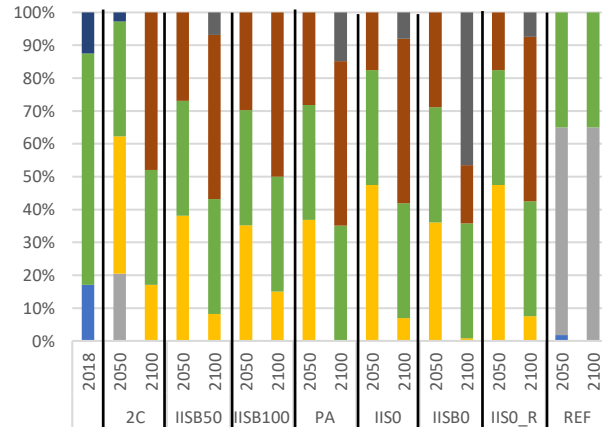

### MEX

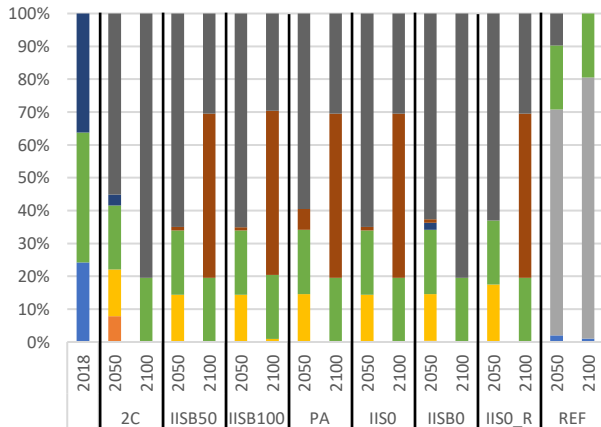

### ODA

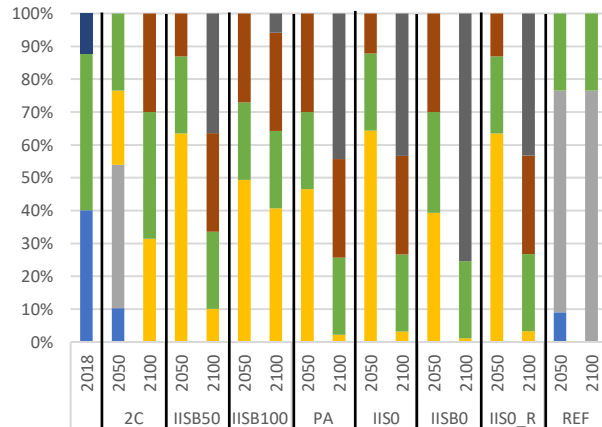

■ Blast furnace  
 ■ Blast furnace CCS  
 ■ Corex  
 ■ Corex CCS  
 ■ DRI H2  
 ■ EAF  
 ■ DRI  
 ■ DRI CCS  
 ■ Ulcolysis  
 ■ Ulcowin

### SKO

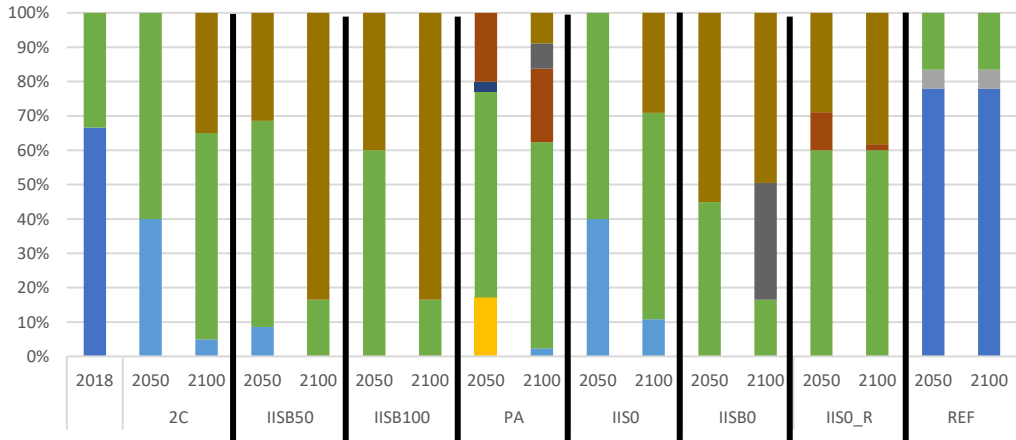

### USA

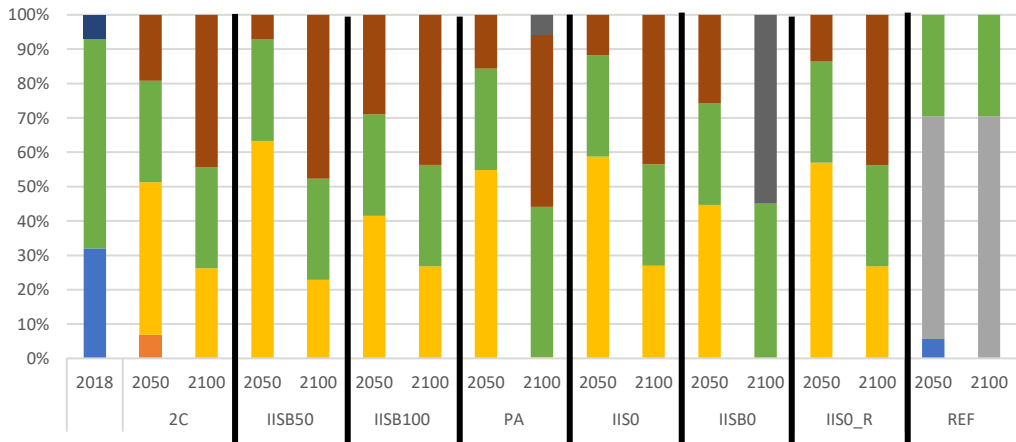

### WEU

