



HAL
open science

Double sky coverage, GeMS Upgrade NGS2 in operation

Vincent Garrel, Brian Chinn, Thomas Hayward, Gaetano Sivo, Eduardo Marin, Chad Trujillo, Cristian Moreno, Ignacio Arriagada, Natalie Provost, Aurea Garcia-Rissmann, et al.

► **To cite this version:**

Vincent Garrel, Brian Chinn, Thomas Hayward, Gaetano Sivo, Eduardo Marin, et al.. Double sky coverage, GeMS Upgrade NGS2 in operation. Adaptive Optics for Extremely Large Telescopes 7th Edition, ONERA, Jun 2023, Avignon, France. 10.13009/AO4ELT7-2023-115 . hal-04402846

HAL Id: hal-04402846

<https://hal.science/hal-04402846>

Submitted on 18 Jan 2024

HAL is a multi-disciplinary open access archive for the deposit and dissemination of scientific research documents, whether they are published or not. The documents may come from teaching and research institutions in France or abroad, or from public or private research centers.

L'archive ouverte pluridisciplinaire **HAL**, est destinée au dépôt et à la diffusion de documents scientifiques de niveau recherche, publiés ou non, émanant des établissements d'enseignement et de recherche français ou étrangers, des laboratoires publics ou privés.



Double sky coverage, GeMS Upgrade NGS2 in operation

Vincent Garrel^a, Brian Chinn^a, Thomas Hayward^a, Gaetano Sivo^a, Eduardo Marin^c, Chad Trujillo^d, Cristian Moreno^a, Ignacio Arriagada^a, Natalie Provost^a, Aurea Garcia-Rissman^a, Francois Rigaut^b, Ian Price^b, and Benoit Neichel^e

^aGemini Observatory - NOIRLAB, c/o AURA, Casilla 603, La Serena, Chile

^bAdvanced Instrumentation Technology Centre, Research School of Astronomy and Astrophysics, Australian National University, Canberra, ACT 2611, Australia

^cW. M. Keck Observatory, 65-1120 Mamalahoa Highway, Kamuela, HI 96743;, USA

^dNorthern Arizona University, Flagstaff, AZ 86011, USA.

^eAix Marseille Univ, CNRS, CNES, LAM, Marseille, France

ABSTRACT

GeMS, the Gemini Multi-Conjugate AO System, is operational and regularly used for science observations since 2013 delivering close to diffraction-limited resolution over a 2" field of view. Its original NGS WFS was delivering TT correction to magnitude 15.5 or brighter. In late 2019, in partnership with ANU, we installed the NGS2 upgrade in the GeMS Canopus bench. NGS2 is based on an EMCCD detector observing the entire field of acquisition and allowing TT and anisoplanatic correction based on the selection of up to 3 regions of interests (mROI) at 800 Hz. We present the performance of this new system compared to the previous one. While we installed this upgrade, the Slow Focus Sensor originally integrated in the NGSWFS was decommissioned. Measuring the relative drifts in the mean sodium altitude is now handled by the Gemini Telescope Peripheral Wavefront sensor (PWFS1), a 6x6 Shack Hartmann. We review the hardware and software modifications we brought to PWFS1 to fulfill this new specialized role. The use of NGS2 and PWFS1 had profound implications on the GeMS operational model, we conclude by assessing those changes.

Keywords: Adaptive Optics, Wavefront Sensing, Multi-Conjugate, Natural Guide Star, Focal Plane Sensing, Tip-Tilt Wavefront Sensor, Detectors, EMCCDs, Filter, Slow focus sensor

Further author information: (Send correspondence to V.Garrel.)
V.Garrel: E-mail: vincent.garrel@noirlab.edu

1. INTRODUCTION

The Multiple Conjugated Adaptive Optics (MCAO) system GeMS [9, 6] has been offered to the Gemini Telescope science community to provide quasi diffraction limited images in the NIR bands with the imager Gemini South Adaptive Optics Imager (GSAOI) since 2013. The wavefront correction for a 2 arcmin field of view is based on the feedback of 5 Laser Guide Stars (LGS) beacons but LGS based wavefront sensor are notoriously unable to measure the Tip Tilt modes. Up to 3 additional Natural Guide Stars (NGS) present in the MCAO field of view can provide this missing information. Several shortcomings and paths to upgrades for GeMS were identified as early as the commissioning and early science verification phase [6]. One of them was the original NGS WFS magnitude limit of $m_R < 15.5$, its origin lying in technical issues. This result severely limited the sky coverage reachable by the instrument, keeping most observable targets close to lower galactic latitudes. This was evaluated in simulations based on stellar populations density; results are presented in the figure 1. The assumptions were that the NGS WFS upgrade system could guide with NGS magnitude down to magnitude $m_R < 17.5$.

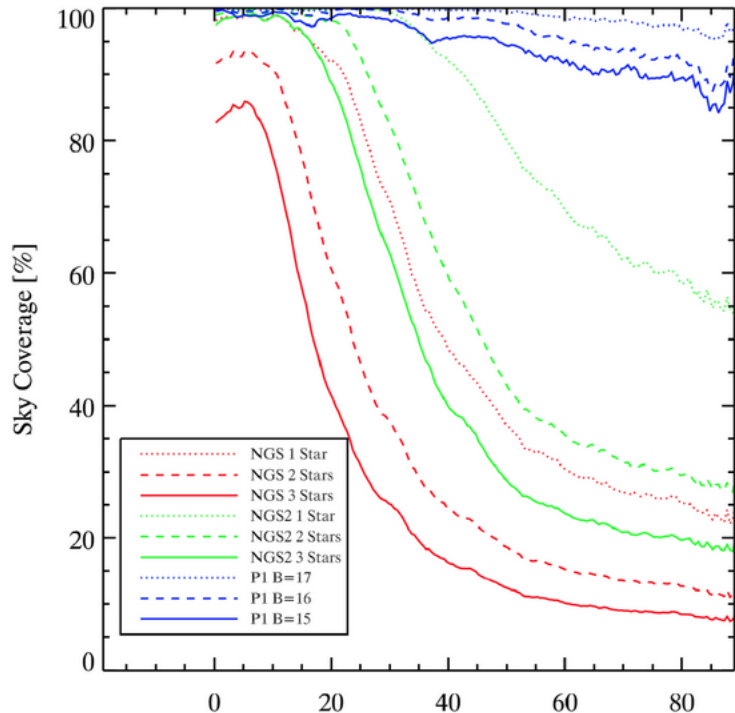
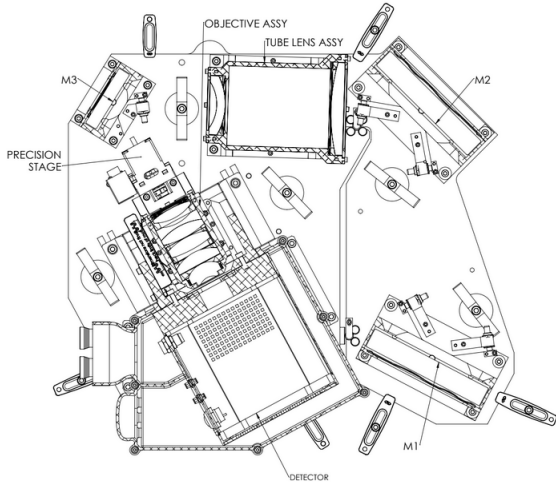

Figure 1: Sky coverage simulations in function of the galactic latitude. NGS lines refers to the original NGS WFS $m_R = 15.5$ while NGS2 refers to the upgrade with an assumed magnitude of $m_R = 17.5$. P1 refers to the sky coverage from PWFS1 with an exposure time of 5 seconds.

Other practical aspects such as the long term reliability and difficult procurement of the APD detectors used as detectors for the NGS WFS, the NGS WFS susceptibility to external vibrations and its lack of visual feedback during acquisitions were also strong incentives to upgrade this system. The upgrade was named "Natural Guide Star Next Generation Sensor" (*NGS²* and quickly became NGS2 for convenience). The origins, specifications, design, subsystem assembly and operational concepts of the upgrade are extensively covered in this earlier reference [10]. We provide the figure 2 as a reminder of the main characteristics. In summary, the NGS2 upgrade is based on a low-noise EMCCD looking at the focal plane, observing the full field of view (FoV). The Nüvü™ EMCCD HNü-512 can deliver addressable multiple regions of interests (mRoI) that can be centered around natural guide stars. The custom NGS2 software is able to configure the EMCCD in 2 modes: full FoV for acquiring guide stars and 3 mRoI boxes to deliver centroids up to 800Hz. In its mRoI mode, the NGS2 measure NGS centroids and synchronize with the GeMS RTC in order to transmit the measured tip tilt.



	As designed
Detector	HNü-512 EMCCD
Format	512x512
Pixel size	16.0 μm
Field of view	119" \times 119"
Pixel scale	0.233"
F-number	1.80
Wavelength range	450-950 nm
Aberrations	> 95%
Distortion	< 2%
Telecentricity	< 3.5°
Interface	F/16
Overall Transmission 500-800 nm	> 87%
Overall Transmission 450-950 nm	> 81%

(a) Optomechanical layout of the NGS2 subsystem

(b) NGS2 optical subsystem specifications

Figure 2: The NGS2 system as presented in the reference [10]

In the following sections, we will introduce a few of the operational model aspects that could not be originally covered in the earlier reference, a verification of the specifications and performance on-sky during the latest phase of the commissioning and introduce further upgrades brought later on to the Telescope Peripheral Wavefront Sensor (PWFS1) as a Slow Focus Sensor.

2. UPDATED NIGHT OPERATION MODEL

The NGS2 subsystem was designed to be as much as possible a drop-in replacement. The NGS2 software can acquire - through the Gemini Telescope EPICS protocol - the assumed positions of up to 3 NGS in the f/16 Gemini telescope focal plane. These positions are calculated by the Telescope Control System (TCS) based on the sky reference angular positions provided by the Phase 2 Tool (now based on the GAIA catalog). The Phase 2 Tool proposes an algorithm to find suitable NGS for both NGS2 and PWFS1 (see section 4) but the Principal Investigator can also manually define them. TCS positions are updated at a frequency of 20Hz to take into account the telescope pointing and variations such as the ones introduced by the differential atmospheric refraction. Featuring static polynomial distortion correction, the NGS2 software accurately translates these positions into pixels coordinates. Through the TCS, non sidereal tracking and differential tracking are fully supported by the NGS2 software. This was verified with tests on Ceres and Neptune while guiding on its satellite moon Triton.

In practice, the telescope operator needs to slightly correct (usually at the few arcsecond level) the position of the telescope after the slew phase for the guide stars to fall within the predefined boxes. This operation is now made very fast, assisted by the live visual feedback from the NGS2 camera in full view mode. Once roughly centered, the operator switches the system to mRoI mode. A first step consists in adjusting the EMCCD gain on-the-fly so that NGS reach an adequate SNR in their guiding boxes. While closing the NGS loop on one of the 3 stars, average of the TT slopes are taken from the 2 other stars in order to provide a sub-pixel offset, this also corrects for potential small catalog errors and internal residual miscalibrations. Once done, the NGS loop integrates the set of defined slopes, with up to 3 stars. This can be done on the fly without opening the loop. The usual size of the mRoI boxes depends from the observed seeing with 6x6 boxes used in good seeing conditions while 8x8 and 12x12 can be used on less favorable ones. Larger mROI have proven particularly useful when gusts of winds over the secondary mirror occur.

For the telescope operator, the visual feedback is done through the GeMS operation tool MYST [8], at usually a few Hz rate. NGS2 features are extremely well integrated with the system through the same EPICS channel protocol, to the point that the NGS2 software GUI is effectively never looked at in operation unless an unexpected bug arises. As can be seen in the figure 3, the MYST Real Time Display reports information such as the last

image taken in full view mode, the display of the 3 boxes and basic estimates such as the actual centroid estimate, min and max pixel values, NGS flux and Full Width Half Max. They can be plotted and tracked live in their respective history buffers. Untracked NGS boxes (not part of the NGS loop) are highlighted with a red frame. If the operator wrongfully enters a too high EMCCD gain, the software is able to analyse the saturation and downscale the gain to a safer level.

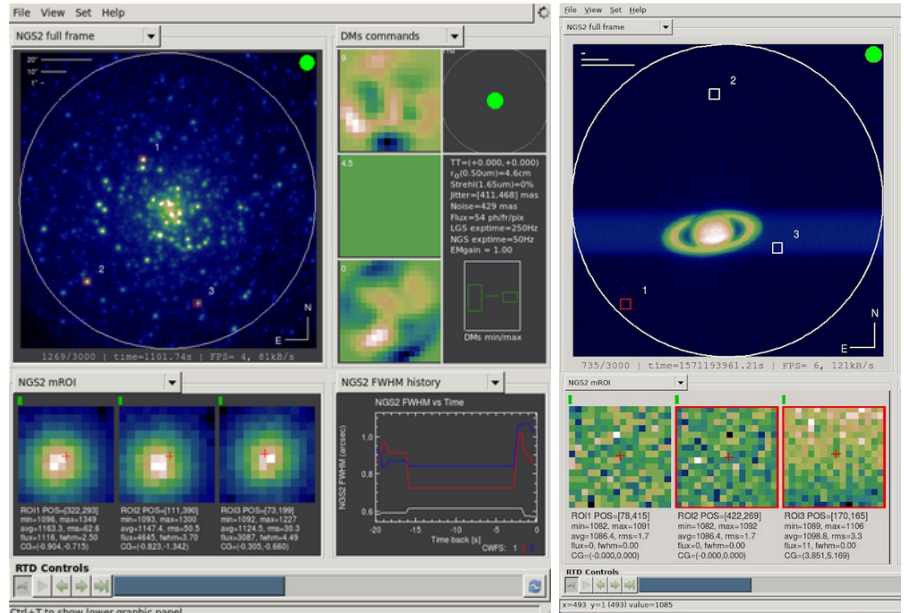

Figure 3: Left: Real Time Display displaying NGS2 relevant information for a configuration with 3 NGS active. Right: RTD taken during the acquisition phase during tests of the differential tracking on Saturn’s moon Titan. The 2 inactive mRoI boxes are show in white in the EMCCD full image and hilghted in red in the 3 boxes.

For the AO system operator, the previous features of the RTC and MYST are fully kept intact. Both MYST and the RTC can update the parameters of the NGS loop on the fly or capture data through their particular buffers (RTD buffers for slow variations or RTC circular buffers for real time events). MYST Smart tools panel, a synthetic report of all the GeMS loop, reports the NGS loop residuals slope as a mean to control the performance.

3. PERFORMANCE

The performance globally follows the predictions made from simulations done in [10]. We present an extract of the commissioning tests made over a excellent seeing night in the figure 4. The tests revealed the NGS loop is stable and achieving higher performance than the previous system down to 3 NGS of $mag_R 18$, at a 50 and 100Hz rate. In practice, we offer NGS2 guiding down to $mag_R = 17.5$ for median seeing conditions for residuals at the 30 miliarcsecond rms level.

Other configurations were tested, including ones where one star is significantly brighter than the 2 others, by up to 4 magnitude. In those tests, the brightest star limits the EMCCD gain that can be used, giving a least favorable SNR for the fainter ones but at higher NGS loop frequencies. We compared the global tip-tilt performance of those bright/faint configurations to the tip-tilt performance where faint stars are excluded from the configuration. At every NGS loop frequency used, the inclusion of such faint stars in the configuration still brings improved performance with reduced tip-tilt residuals.

The NGS loop controller used in GeMS for the tip-tilt loop is a classical integrator. From the RTC circular buffers data, the NGS rejection transfer functions can be extracted. We present in figure 5 2 examples with different integrator gains. The data can be adequately fitted to a the integrator model. The fitted model revealed that the real time data transfer and synchronization between the NGS2 software and the GeMS RTC does not

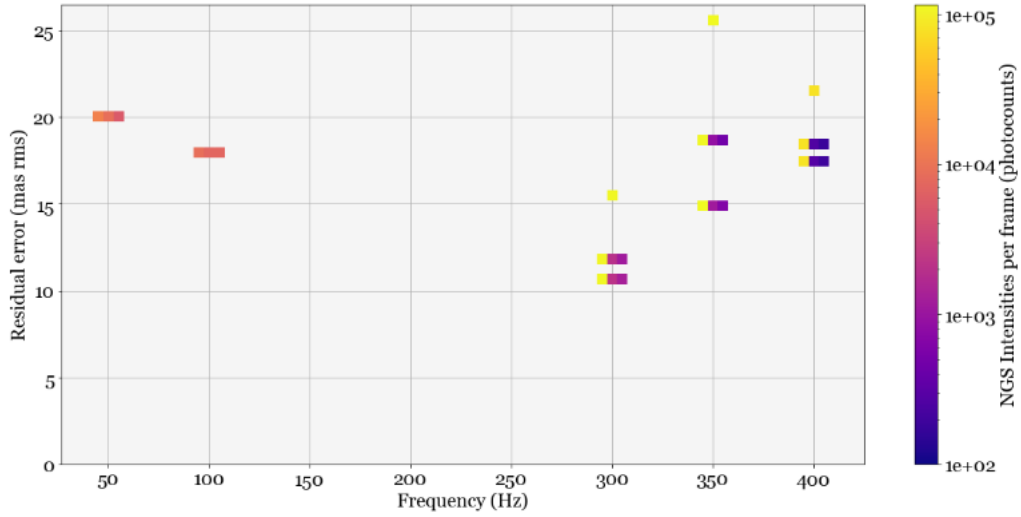

Figure 4: Extract of the performance measured as the residuals of the global tip tilt loop, in function of the loop frequency and the NGS 3 stars configuration. Pink configurations represents 3 faint stars (mag_G 18 to 18.2). For the tests on the magnitude difference, yellow plots are representing $\text{mag}_G = 12$ while purple ones are $\text{mag}_G = 15.9/16$. Tests on the fainter guide stars were taken in significantly better seeing than the ones testing the magnitude difference.

introduce significant unexpected delay to the loop other than the classic one-frame delay due to the EMCCD integration time. The current delay is estimates to 2.4 frames, conform to the required integration time and RTC calculation time.

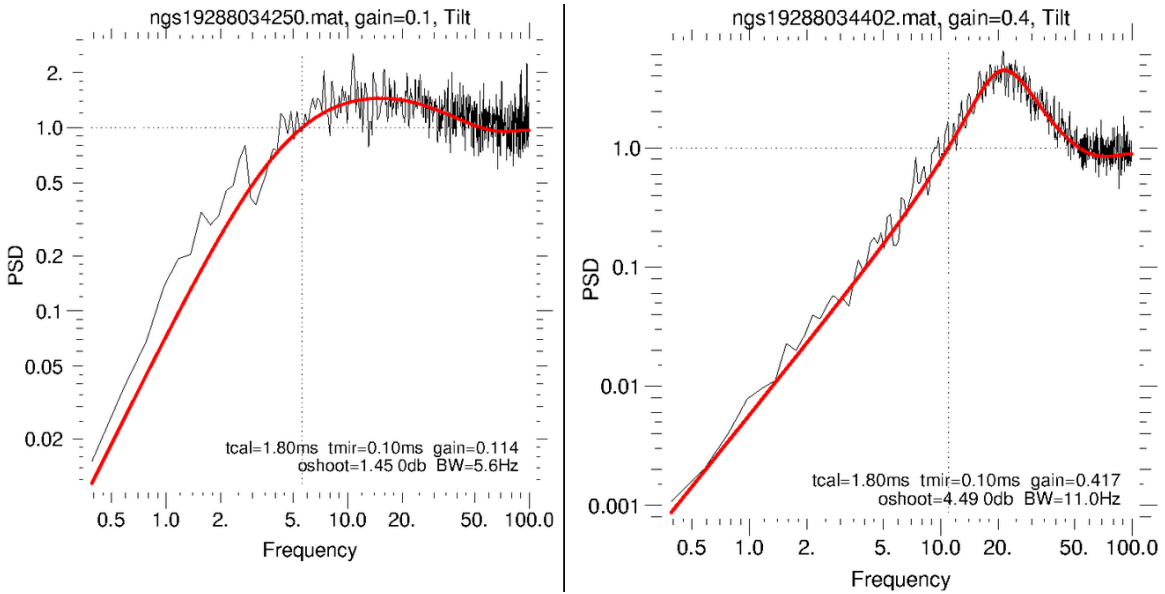

Figure 5: Rejection transfer function taken at 200Hz NGS loop frequency with a gain of $g=0.1$ (left) and $g=0.4$ (right). The red curves represent the fitted integrator law model used to estimate the pure frame delay.

Additionally to the global tip tilt, in a MCAO configuration, the RTC can also correct for anisoplanatic tip-tilt modes [1]. This mode was commissioned with the previous NGS WFS but the stability and performance

of that particular loop were not optimal as the 3 mechanical probes tended to be prone to complex mechanical effects such as compounded flexure (the probes were mounted on top of each other mechanically). NGS2, with its monolithic single EMCDD able to see the full field at once, is more stable and infinitely easier to calibrate. The anisoplanatic modes modify the plate scale. We measure about a small plate scale change of 4 milliarcsecond per arcsecond of FoV as the practical maximum control for this loop. It also affect the distortion pattern 7 induced by the internal 2 off-axis parabolae from the AO bench Canopus. This first analysis needs to be confirmed with the science instrument GSAOI and accurately quantifying this effect will be the object of further work.

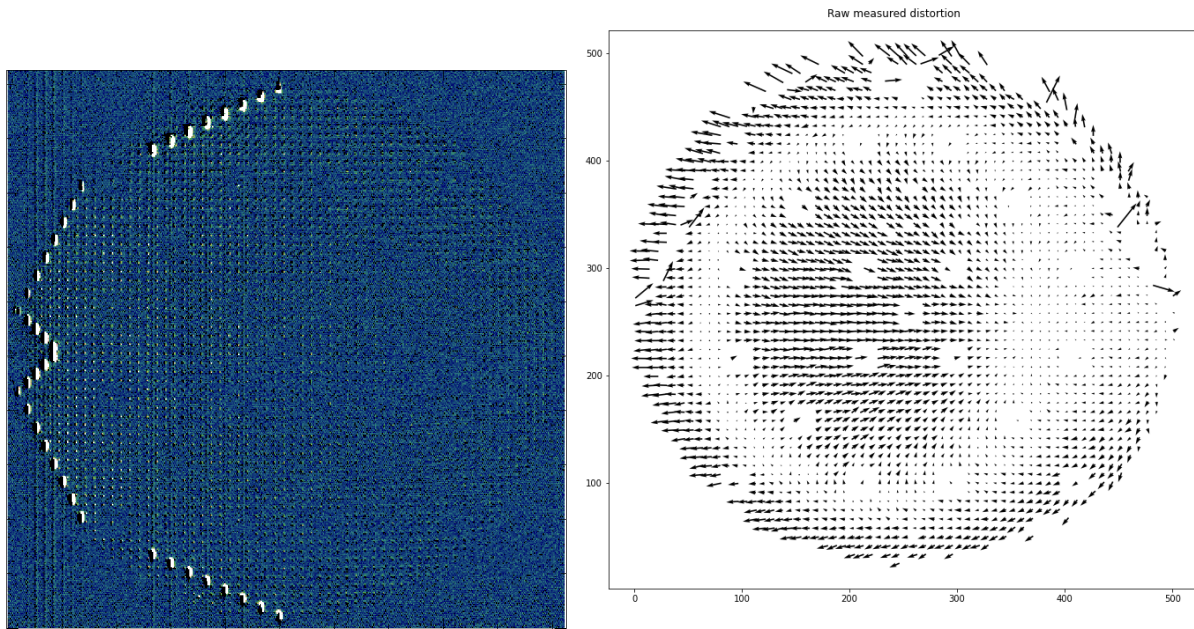

Figure 6: Left: Raw difference image between a radial anisoplanatic synthetic DM shapes with a strong stroke and the reference DM shapes as seen by the NGS2 camera as seen on the GeMS NGS internal calibration mask. Right: rotated in the same frame as the science instrument GSAOI, the raw differential distortion post plate-scale fitting

4. NGS FOCUS SENSING WITH PWFS1

The mean altitude of the mesospheric sodium layer naturally slowly varies through the night. Left unattended, observing a LGS beacon with a wavefront sensor will induce an extra drifting focus term degrading the AO reconstruction. The properties of this well known atmospheric effect has been studied both in the astronomy domain [7] [5] and in the frame of atmospheric science [4] [11]. Assuming the atmospheric turbulence averages over time, the commonly used method consists in adding a long integration wavefront sensor able to measure focus on a natural guide star to either introduce offsets on the slopes or on the LGS Wavefront focusing optics. Such additional wavefront sensor is dubbed a Slow Focus Sensor(SFS) in GeMS. Other methods have been proposed [3] to measure this effect but also the evolution of the sodium layer density profile using existing technology.

The original NGS WFS installed on the MCAO Canopus bench integrated a SFS system. One of the 3 mechanical probes divided in a 70/30 ratio the visible light to the tip tilt sensor and the slow focus sensor. Effectively the GeMS SFS was 2x2 Shack-Hartmann observing within the MCAO corrected field, i.e. a 2 arcmin diameter disk and was located downstream from the Canopus deformable mirrors.

Since the NGS2 integration cannot accommodate such a subsystem, decision was taken to take advantage of an existing system to replace the original SFS in its functionalities. While the Gemini North PWFS1 was modified as a 2x2 Shack Hartmann guider to be used with the AO system Altair, the Gemini South PWFS1 remained untouched as a 6x6 Shack-Hartmann. This system can therefore measure a focus term and is still

commonly used to tune the Gemini M1 figure at the start of the observing night for seeing limited instruments and sometimes used as a fallback option guider. Any modification required for its use as a Slow Focus Sensor had to keep intact its original functions.

The first optimization consisted in adding permanently an optimal optical notch filter within the PWFS1 system. The notch frequency is centered around the laser wavelength in order to reject laser scattered light that could degrade the SFS focus measurements on sometimes very faint NGS. The only alternative original filter within the PWFS1 was the blue B filter. It downgraded the sensitivity of the system by 2 magnitudes, reducing the sky coverage reachable by the MCAO system.

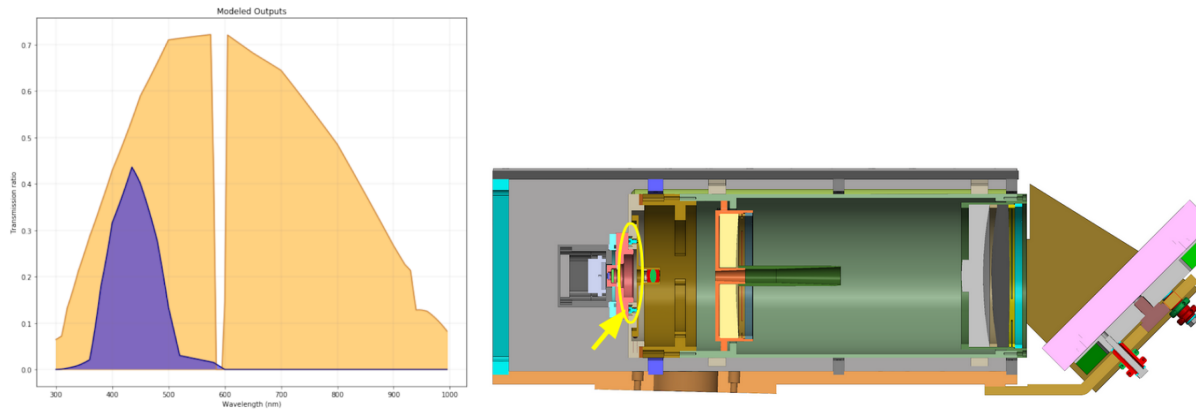

Figure 7: Left: Modelisation of the throughput for LGS notch filter (in orange), taken into account the atmosphere, internal throughput of the WFS optics and QE of the CCD. As a comparison the throughput of the blue filter originally present in the PWFS1 system (in blue) in the same conditions. Right: The notch filter is permanently mounted in the collimated beam of the WFS. It required a complete disassembly of the system.

Benefiting from the past experience from the conversion of the GN PWFS1 [2], we installed the notch filter in the collimated beam in order to minimize its influence on the existing PWFS, in a specially designed fixed mount. The original filter set could be kept. The marginal loss of throughput does not slow down the M1 tuning operation, which is done on bright stars. The on-sky tests revealed the change of wavefront is invisible due to the filter is invisible under any seeing.

The second optimizations were done on the PWFS1 software. The original PWFS1 software was extensively calibrated along the existence of the telescope. We decided to keep this original software and modify it for the SFS use: allowing longer exposures were one of the first modifications. The commissioning phase and later operations revealed that further optimizations were required to correct for some real life behavior (glitches and filtering, originally customized for a use at a range of 50 to 200Hz). The PWFS1 software now delivers a raw unfiltered focus whenever the PWFS1 exposure time is slower than 10Hz, i.e. effectively for its SFS use.

The slow focus loop from its infancy was not handled by the GeMS RTC but taken care of by the supervisor MYST [6]. The software was modified to receive the focus measurements from the PWFS1 and recalibrated. Ultimately, the correction is done through calibrated offsets to the LGS WFS remote controlled opto-mechanism.

In order to not vignette the MCAO Field of View, the PWFS1 NGS patrol field is defined by an annulus with internal diameter of 5.8 arcminute and external of 6.95 arcminute. At such a distance from the AO corrected field, in the visible band, it fully operates in a seeing limited mode. As it looks directly on the sky behind the telescope, it is effectively sensing the instrument focus with a delay due to the slow offload of the DM0 mirror focus term to the secondary mirror.

In nighttime operation, those changes made the SFS loop slow to converge for the initial acquisition phase. The reference point of the SFS focus was also more difficult to assess since the science instrument GSAOI focal plane is not perfectly co-planar with the PWFS1 field of patrol, which adds an additional uncalibrated focus term. We therefore now perform an automated focus run in open SFS loop and evaluate the performance with

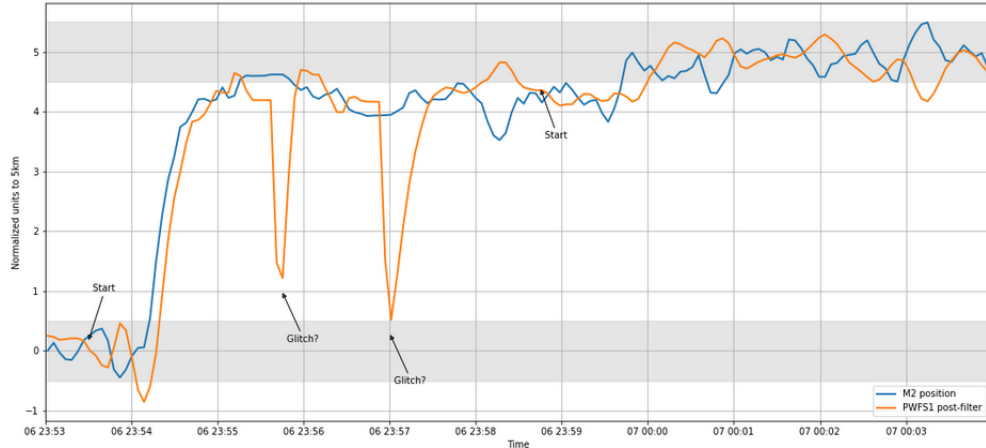

Figure 8: Example of the behavior of PWFS1 focus measurements after a first manual offset equivalent to 4.5km of sodium layer defocus has been applied to the secondary mirror of the telescope. A second offset of 0.5km is later applied. The grey bands of 1km large display the domain where the PSF displayed on the instrument GSAOI are considered stable in Strehl Ratio. This test was done prior to the change to a simpler version of the PWFS1 focus are now delivered raw to MYST.

the science instrument. The SFS loop is set with a new zero point at each new science target. We are planning ahead further work to reduce the time consumed in this process.

5. CONCLUSION AND FUTURE WORK

A large effort has been successfully devoted to make NGS2 not only a performance upgrade but also an easy-to-operate one. It opens up the sky and offer newer science opportunities for GeMS fed instruments to observe beyond the galactic plane. It is now routinely and reliably offered for years to the Gemini science community. Significant changes have also been done to improve the behavior and sensitivity of PWFS1 as the GeMS Slow focus sensor but some optimization and calibration could further increase its accuracy.

ACKNOWLEDGMENTS

The NGS2 upgrade was originally made possible with support under Australian Research Council’s Linkage Infrastructure Equipment and Facilities funding scheme (project number LE140100013). We acknowledge financial support from the Australian National University, the Swinburne University of Technology, the Australian Astronomical Observatory and the Gemini observatory.

The Gemini Observatory is operated by the Association of Universities for Research in Astronomy, Inc., under a cooperative agreement with the NSF on behalf of the Gemini partnership: The National Science Foundation (NSF, United States), the National Research Council (NRC, Canada), the Comisión Nacional de Investigación Científica y Tecnológica (CONICYT, Chile), the Ministério da Ciência, Tecnologia e Inovação (MCTI, Brazil), the Ministerio de Ciencia, Tecnología e Innovación Productiva (MCTIP, Argentina) and the Korea Astronomy and Space Science Institute (KASI, Republic of South Korea).

We are very thankful to Pierre Jouve and Taissir Heritier for their help in the preparation of all the numerous tiny details for AO4ELT !

References

- [1] Giulia Carlà et al. “Tip-tilt anisoplanatism in MCAO-assisted astrometric observations”. In: *Adaptive Optics Systems VIII*. Ed. by Laura Schreiber, Dirk Schmidt, and Elise Vernet. Vol. 12185. Society of Photo-Optical Instrumentation Engineers (SPIE) Conference Series. Aug. 2022, 121850O, 121850O. DOI: [10.1117/12.2627126](https://doi.org/10.1117/12.2627126). arXiv: [2209.00912](https://arxiv.org/abs/2209.00912) [astro-ph.IM].

- [2] Gemini. *Altair modes with PWFS1*. 2023. URL: <https://www.gemini.edu/instrumentation/altair/modes> (visited on 10/13/2023).
- [3] Joshua A. Hellemeier et al. “Measuring line-of-sight sodium density structure using laser guide stars”. In: 494.2 (May 2020), pp. 2798–2808. DOI: [10.1093/mnras/staa808](https://doi.org/10.1093/mnras/staa808). arXiv: [2001.06844](https://arxiv.org/abs/2001.06844) [[astro-ph.IM](#)].
- [4] Martin P. Langowski et al. “Comparison of global datasets of sodium densities in the mesosphere and lower thermosphere from GOMOS, SCIAMACHY and OSIRIS measurements and WACCM model simulations from 2008 to 2012”. In: *Atmospheric Measurement Techniques* 10.8 (Aug. 2017), pp. 2989–3006. DOI: [10.5194/amt-10-2989-2017](https://doi.org/10.5194/amt-10-2989-2017).
- [5] B. Neichel et al. “Characterization of the sodium layer at Cerro Pachón, and impact on laser guide star performance”. In: 429.4 (Mar. 2013), pp. 3522–3532. DOI: [10.1093/mnras/sts631](https://doi.org/10.1093/mnras/sts631). arXiv: [1301.3690](https://arxiv.org/abs/1301.3690) [[astro-ph.IM](#)].
- [6] Benoit Neichel et al. “Gemini multiconjugate adaptive optics system review - II. Commissioning, operation and overall performance”. In: 440.2 (May 2014), pp. 1002–1019. DOI: [10.1093/mnras/stu403](https://doi.org/10.1093/mnras/stu403). arXiv: [1402.6906](https://arxiv.org/abs/1402.6906) [[astro-ph.IM](#)].
- [7] T. Pfrommer and P. Hickson. “High resolution mesospheric sodium properties for adaptive optics applications”. In: 565, A102 (May 2014), A102. DOI: [10.1051/0004-6361/201423460](https://doi.org/10.1051/0004-6361/201423460).
- [8] F. Rigaut et al. “MYST: a comprehensive high-level AO control tool for GeMS”. In: *Adaptive Optics Systems II*. Ed. by Brent L. Ellerbroek et al. Vol. 7736. Society of Photo-Optical Instrumentation Engineers (SPIE) Conference Series. July 2010, 77362H, 77362H. DOI: [10.1117/12.856755](https://doi.org/10.1117/12.856755).
- [9] François Rigaut et al. “Gemini multiconjugate adaptive optics system review - I. Design, trade-offs and integration”. In: 437.3 (Jan. 2014), pp. 2361–2375. DOI: [10.1093/mnras/stt2054](https://doi.org/10.1093/mnras/stt2054). arXiv: [1310.6199](https://arxiv.org/abs/1310.6199) [[astro-ph.IM](#)].
- [10] François Rigaut et al. “NGS2: a focal plane array upgrade for the GeMS multiple tip-tilt wavefront sensor”. In: *Adaptive Optics Systems V*. Ed. by Enrico Marchetti, Laird M. Close, and Jean-Pierre Véran. Vol. 9909. Society of Photo-Optical Instrumentation Engineers (SPIE) Conference Series. July 2016, 99091X, p. 99091X. DOI: [10.1117/12.2230481](https://doi.org/10.1117/12.2230481).
- [11] Fan Yang and Alan Z. Liu. “Stability Characteristics of the Mesopause Region Above the Andes”. In: *Journal of Geophysical Research (Space Physics)* 127.9, e30315 (Sept. 2022), e30315. DOI: [10.1029/2022JA030315](https://doi.org/10.1029/2022JA030315).