



**HAL**  
open science

## Design and prototyping of HARMONI's light-injection module for AO calibrations

Noah Schwartz, Kjetil Dohlen, Kacem El Hadi, Emre Karacar, Jean-François Sauvage, Lisa Bardou, Tim Morris, Martin Black

► **To cite this version:**

Noah Schwartz, Kjetil Dohlen, Kacem El Hadi, Emre Karacar, Jean-François Sauvage, et al.. Design and prototyping of HARMONI's light-injection module for AO calibrations. Adaptive Optics for Extremely Large Telescopes 7th Edition, ONERA, Jun 2023, Avignon, France. 10.13009/AO4ELT7-2023-056 . hal-04402842

**HAL Id: hal-04402842**

**<https://hal.science/hal-04402842>**

Submitted on 18 Jan 2024

**HAL** is a multi-disciplinary open access archive for the deposit and dissemination of scientific research documents, whether they are published or not. The documents may come from teaching and research institutions in France or abroad, or from public or private research centers.

L'archive ouverte pluridisciplinaire **HAL**, est destinée au dépôt et à la diffusion de documents scientifiques de niveau recherche, publiés ou non, émanant des établissements d'enseignement et de recherche français ou étrangers, des laboratoires publics ou privés.



# Design and prototyping of HARMONI's light-injection module for AO calibrations

Noah Schwartz<sup>\*a</sup>, Kjetil Dohlen<sup>b</sup>, Kacem El Hadi<sup>b</sup>, Emre Karacar<sup>b</sup>, Jean-François Sauvage<sup>c,b</sup>, Lisa Bardou<sup>d</sup>, Tim Morris<sup>d</sup>, Martin Black<sup>a</sup>

<sup>a</sup>UK Astronomy Technology Centre, Blackford Hill, Edinburgh EH9 3HJ, United Kingdom;

<sup>b</sup>Marseille Univ, CNRS, LAM, Laboratoire d'Astrophysique de Marseille, Marseille, France;

<sup>c</sup>DOTA, ONERA, F-13661 Salon cedex Air - France; <sup>d</sup>Dept. Centre for Advanced Instrumentation, Durham University, South Road, Durham, DH1 3LE, United Kingdom

## ABSTRACT

In this paper, we present the design of the Adaptive Optics Calibration Unit (AOCU) of the HARMONI instrument, focusing on the light-injection module. We present theoretical photometric budget and evaluate experimental performance in the laboratory. We show that despite large attenuations ranging from  $10^2$ - $10^8$ , the scheme delivers the required beam quality (flux, geometry). Owing to the good performance and high level of flexibility of this scheme we are planning on using it for the AOCU and to replicate it for several other internal light-sources of HARMONI.

**Keywords:** ELT, Calibrations, Adaptive optics, Light source, Optical fibres, HARMONI.

## 1. INTRODUCTION

HARMONI<sup>1</sup> is the first-light visible and near-IR integral field spectrograph for the ELT. It covers a large spectral range from 450 nm to 2450 nm with resolving powers from 3500 to 18000 and spatial sampling from 60 mas to 4 mas. It can operate in two Adaptive Optics [AO] modes – SCAO<sup>2,3</sup> (including a High Contrast<sup>4</sup> capability) and LTAO<sup>5</sup> - or with NoAO. The project is preparing for Final Design Reviews.

The Calibration Module of HARMONI sits just in front of the telescope focal plane and injects calibration light into the system. It can be completely withdrawn to allow normal observations. The calibration module is comprised of three separate units: the IFS calibration unit, the Geometric calibration unit, and the AO calibration unit (AOCU).

The goal of the AO calibrations is to provide the necessary data to close and optimise the various AO loops during scientific observations (e.g., reference slopes, interaction matrices, NCPA...). AO calibrations are fundamentally different from science calibrations, in that they must be taken *before* the observations, and are used to optimise performance rather than correct effects post-facto. The AO calibration Unit<sup>6</sup> (AOCU) is part of the Calibration Module and feeds both the SCAO and LTAO natural guide-star sensors. The AOCU provides illumination to the Natural Guide Star (NGS) system and the Integral Field Spectrograph (IFS). Note that the calibration module does not support any calibration for the LGS WFS, as they have their own internal sources. It is comprised of 7 on-axis calibration sources (covering approx. 0.5-2.4  $\mu\text{m}$ ) with a controllable wavefront shape (i.e., via a deformable mirror in the pupil plane).

The paper is divided as follows. In section 2 we present HARMONI and its main systems, focusing on the adaptive optics calibrations. We describe the AO calibration unit and in particular the illumination architecture combining multiples LEDs in to single-mode fibres. In section 3 we present the laboratory test results and conclude section 4.

\*noah.schwartz@stfc.ac.uk

## 2. ADAPTIVE OPTICS CALIBRATIONS

### 2.1 Adaptive optics calibration unit

The AO calibration unit provides the necessary illumination to the NGSS to calibrate the SCAO, HCAO, and LTAO-NGS WFSs, calibrate the instrument deformable mirrors, measure the interaction matrices between instrument WFSs and instrument DMs, and calibrate non-common-path aberrations (NCPA) between the SCAO, HCAO, and LTAO-NGS (Truth Sensor) WFSs, and the science path. The AOCU also calibrates the constant offset term of the instrument's pointing model (i.e., the zero position of the SCAO and LTAO-NGS guide probe navigation mechanisms with respect to the science FOV). The AOCU is part of the Calibration Module (CM), see Figure 1.

The CM sits just in front of the telescope focal plane and injects calibration light into the system. It can be completely withdrawn to allow normal observations. The calibration module is comprised of three separate units: the IFS calibration unit, the Geometric calibration unit (GCU), and the AO calibration unit (AOCU). The AO fold mirror (AOFM) allows for the injecting the AOCU light in the instrument. Two focus stages enable the AOCU to be moved into position to inject light into the system (moving AOCU and AOFM at the same time) and to move the AOCU linearly in the field (moving the AOCU stage while keeping the AOFM in place).

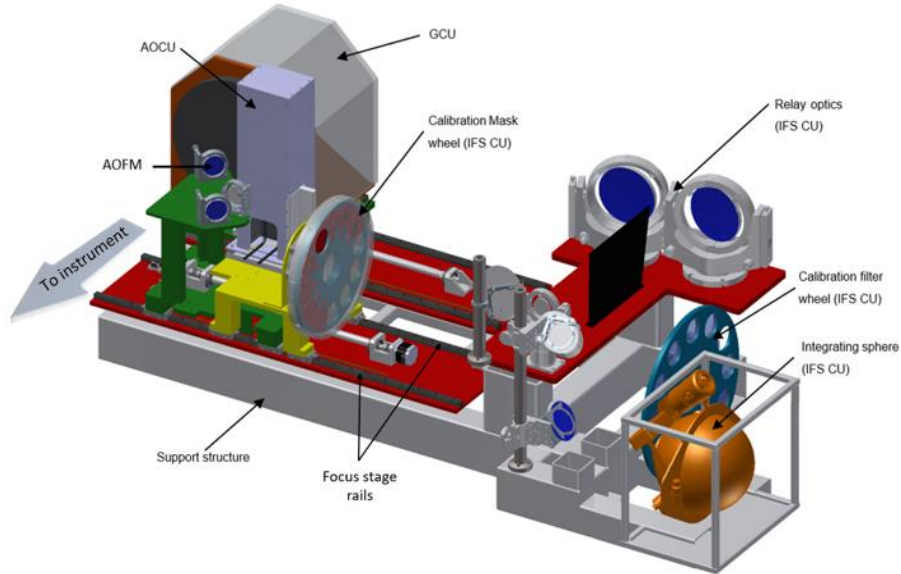

Figure 1: Overall view of the calibration module, showing the AOCU, AO fold mirror (AOFM), and the 2 focus stages (the positioning stage in green, and the focus stage in yellow).

The AO calibration unit consists of a relay, imaging object sources in the form of fibre tips onto the telescope focal plane via a low-order deformable mirror (CalDM). The AOCU includes diffraction-limited sources, and an extended source that are not suitable for the GCU. CalDM is located in the pupil of the telescope, projected at the appropriate pupil distance via the relay optics. The outer edge of the pupil is materialized by a mask placed in front of the CalDM.

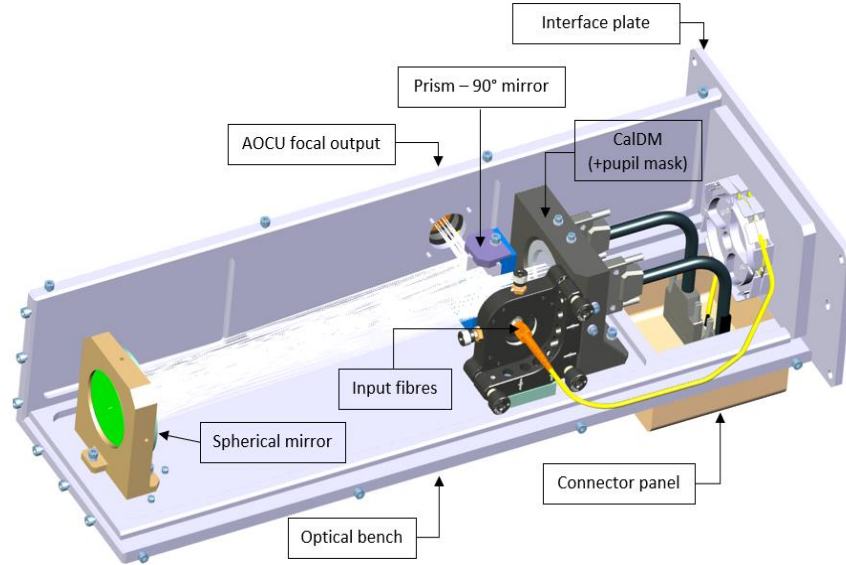

Figure 2: AOCU design with main element highlighted, cover removed.

The AOCU includes the following main components:

- **Deformable mirror:** CalDM, identical to the SCAO low-order DM [LODM], allowing a controllable wavefront.
- **Pupil Mask:** representing the external shape of the ELT entrance pupil (M1).
- **Relay optics:** a spherical collimator mirror and a roof-top mirror.
- **Input fibre bundle:** providing illumination.
- **Monochromatic sources:** seven LEDs sources connected to the fibre bundle (located in the electronics cabinets).

These items (except for the LED light sources and the fold mirror) are mounted on a small optical bench. The optical bench is then mounted on a positioning stage that is part of the Calibration Module sub-system, providing with patrolling and focus control capabilities.

## 2.2 Adaptive optics calibrations

The natural guide star sensors collect all the natural guide star sensing (NGSS) functionality in a single place. These support the four operating modes of the instrument: the SCAOS sub-system, the High Contrast module, and the low order wavefront sensors (LOWFS), which supports LTAO and NoAO operations. LOWFS includes secondary guiding (NoAO), fast tip-tilt-focus and truth sensors (for LTAO), all of which share a common moveable pick-off. A summary of the different modes and the main parameters of their relative sensors is presented Figure 3.

### SCAO mode

- PyrS a 100x100 modulated Pyramid WFS, at 500 Hz,  $\lambda=700-800/1000$  nm
- BlueSH an 15x15 SH-WFS, at 1 Hz,  $\lambda= 625-675$  nm for low-order NCPA

### LTAO mode

- TTFS a 2x2 SH-WFS measuring tip-tilt and focus, at 500 Hz,  $\lambda=1.2-1.8\mu\text{m}$
- TruthS a 10x10 SH-WFS for low-order aberrations, at 1 Hz,  $\lambda= 0.95-1.2\mu\text{m}$

### High-Contrast mode

- Zelda a 200x200 Zernike wavefront sensor for high-order NCPA, at 0.1 Hz, bandwidth in range  $\lambda = 1.15-1.2 \mu\text{m}$

### Science and No AO mode

- SGS (x2) secondary guiding to ensures focal plane stability, at  $\sim 0.1$  Hz,  $\lambda= 1.2-1.8\mu\text{m}$
- Science detectors:  $0.47-2.45 \mu\text{m}$

Figure 3: Description of the different AO modes of HARMONI and of the main AO-related parameters.

### 2.3 Illumination module

The source module (located away from the AOCU box itself, in the electronics cabinets) will be some distance from the optical output and thus fibres are used to route the sources' output to the AOCU. The multiple sources are fed along individual off-the-shelf fibres to a breakout panel (connector panel, CP) mounted on the main AOCU structure. At this interface the fibres connect to a fibre bundle combining them to a single input to the system. The bundle will consist of two individual single mode fibres and one multimode fibre. The general architecture of the illumination system is presented Figure 4.

Each LED source is coupled into a 200  $\mu\text{m}$  multimode optical fibre. A small proportion of light is sent to a photodiode for monitoring using an off-the-shelf 1x2 multimode fibre optic coupler. In some cases, multiple sensors need be illuminated simultaneously (e.g., Pyramid and Blue Shack-Hartmann WFS for SCAO calibrations). As such they need to be brought together into a common fibre. This done using an off-the-shelf 50:50 1x2 multimode fibre optic coupler. The remaining 3 multimode optical fibres are routed through the instrument to the AOCU bench. Finally, to produce diffraction-limit sources we use a single-mode fibre that is butt-coupled to the multimode fibres. In order to transmit multiple wavelengths over the large bandwidth, we use photonic-crystal fibres (LMA-5, NKT Photonics) to be able to transmit  $\lambda=0.65\text{-}1.8 \mu\text{m}$  (BlueSH, PyrS, Zeld, Science) and  $\lambda\approx 1.2\text{-}1.7 \mu\text{m}$  (TTFS).

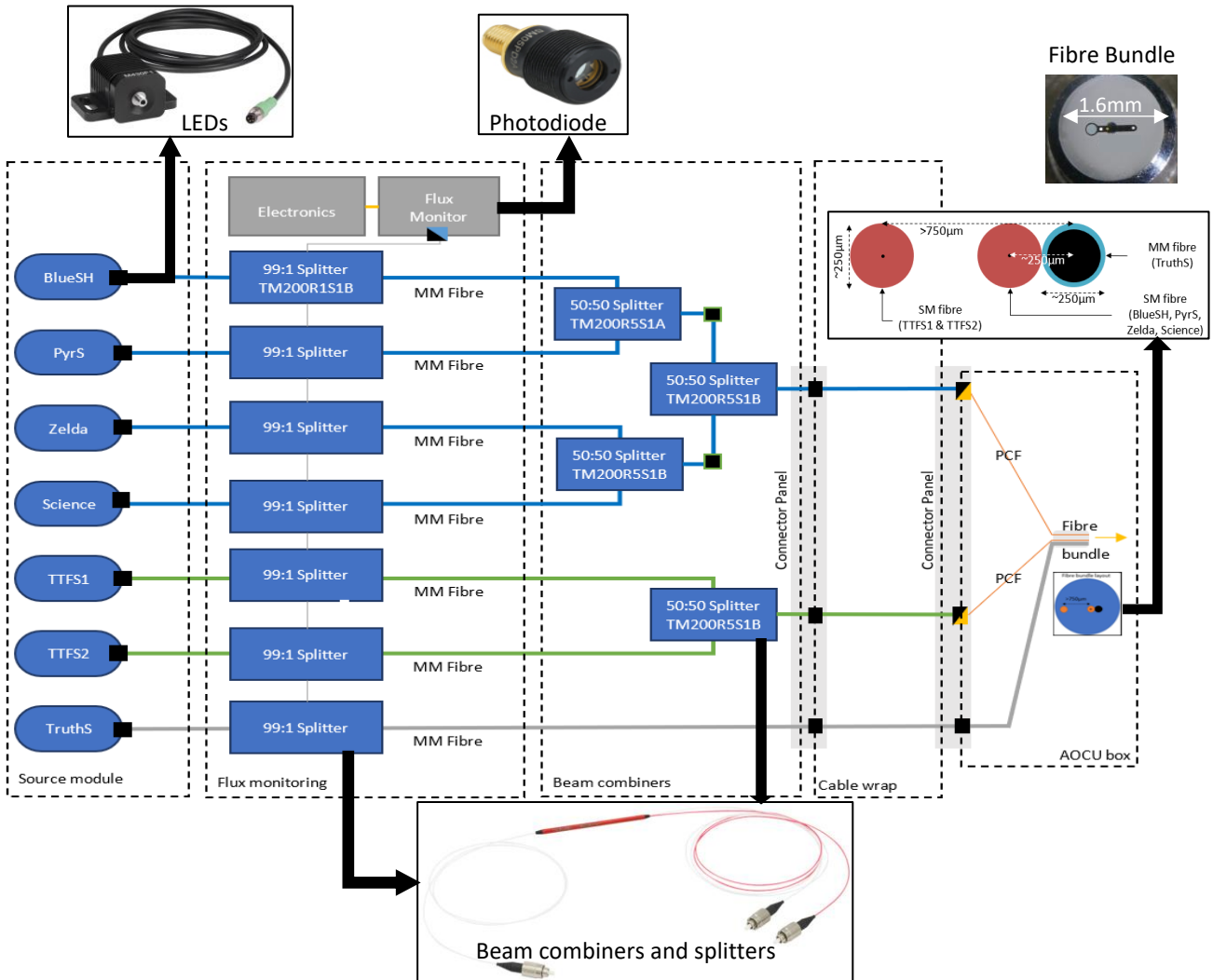

Figure 4: General AOCU illumination architecture.

## 2.4 Spectrum

As seen in Figure 3, the 7 sensors operate at different wavelengths with little overlap. In addition, each light sources need to be operated individually. We use 7 off-the-shelf fibre-coupled LEDs (Thorlabs) coupled into 200  $\mu\text{m}$  MM fibres. Figure 5 shows the 7 sources uses for the illumination of the 6 different sensors.

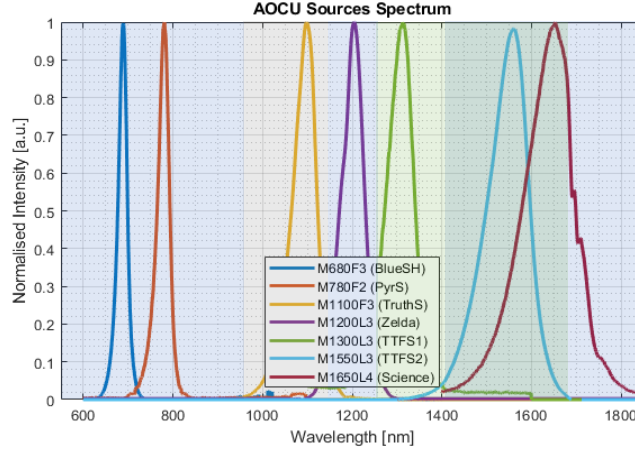

Figure 5: Source spectrum for the 7 LEDs using in the AO calibration unit. Sources are off-the-shelf fibre coupled LEDs.

## 2.5 Theoretical attenuation

For the AOCU illumination, the LED sources suffers from attenuation losses. Several terms are considered (see Figure 4):

- **Injection loss.** This is due to the LED injection into the 200  $\mu\text{m}$  MM fibre. As the off-the-shelf sources used are already fibre-coupled, the values specified in the datasheets already include this, and no additional losses are considered at this stage.
- **Beam splitter/coupler loss.** This is the loss due to splitting the light for monitoring and for combining different light sources together. Exact values to be estimate by experiment.
- **Connector loss.** This is due to the need to couple MM fibres together using either SMA or FC/PC connectors. FC/PC. Typical insertion losses are  $<0.1\text{dB}$  (or 0.89) for FC/PC to FC/PC and  $<1.5\text{dB}$  (of 0.7) for SMA to SMA. For this reason, we will favour FC/PC connectors where possible.
- **MM to SM coupling.** Coupling multimode fibre into a single-mode fibre. The ratio of power between the MM and the SM fibres is given by<sup>6</sup>:  $\eta = E_{\text{MM}}/E_{\text{SM}} = ((\pi \cdot D \cdot \text{NA})/\lambda)^2$ , D is the diameter of MM fibre, NA the numerical aperture of the MM fibre, and  $\lambda$  the LED wavelength.
- **Telescope F#.** Losses due to the limited NA of the telescope (see below).
- **Transmission and dichroics.** General transmission of optics and dichroics in the system. Estimated by design and information provided by manufacturers.
- **QE of the detector.** Further losses due to quantum efficiency, estimated using datasheet.

The telescope has a F ratio of  $F_{\text{tel}} = 1/(2\text{NA}) = 17.75$ , so only part of the light emitted by the calibration source LEDs will go through the system. The MFD of single mode fibres is the width measured at an intensity equal to the product of  $e^{-2}$  and the peak intensity. The MFD encloses  $\sim 86\%$  of the beam's power. The flux emitted by the AOCU sources are emitted with

an angle defined by  $\Theta_{\text{SM}}$  such that:  $\Theta_{\text{SM}} = \frac{\lambda}{\pi(\text{MFD}/2)}$ . The flux distribution of the single mode fibre is:  $I(\theta) = e^{-2\left(\frac{\theta}{\Theta_{\text{SM}}}\right)^2}$ .

The flux emitted by the LED light source is therefore:

$$\int_0^{2\pi} \int_0^{\infty} e^{-2\left(\frac{\theta}{\Theta_{\text{SM}}}\right)^2} \theta d\theta d\varphi = \frac{\pi\Theta_{\text{SM}}^2}{2}$$

Finally, the flux captured due to the limited telescope NA is:

$$\int_0^{2\pi} \int_0^{NA_{\text{tel}}} e^{-2\left(\frac{\theta}{\Theta_{\text{SM}}}\right)^2} \theta d\theta d\varphi = \frac{\pi\Theta_{\text{SM}}^2}{2} \left(1 - e^{-2\left(\frac{NA_{\text{tel}}}{\Theta_{\text{SM}}}\right)^2}\right)$$

Table 1 provides a summary of the transmission from emission to the detectors for the different wavelengths. The 1100 nm (TruthS) is the only source that is MM until the end, so the beam combination and coupling values are set to 1, leading to high transmission.

Table 1: Summary of the transmission for the calibration unit.

$\lambda$ [nm]	Monitoring splitters	Beam combination	Connector loss	MM-SM coupling	Telescope F#	Optical transmission	Detector QE	Total
680	0.7	0.042	0.47	2.4E-05	1.43E-01	0.38	0.47	8.5E-09
780	0.75	0.042	0.47	3.2E-05	1.13E-01	0.61	0.90	2.9E-08
1100	0.50	1	0.57	1	6.18E-02	0.64	0.85	9.6E-03
1200	0.75	0.053	0.47	7.5E-05	5.31E-02	0.74	0.22	1.2E-08
1300	0.60	0.246	0.57	8.8E-05	4.62E-02	0.64	0.70	1.5E-07
1550	0.50	0.238	0.57	1.3E-04	3.42E-02	0.60	0.70	1.3E-07
1650	0.65	0.049	0.47	1.4E-04	3.08E-02	0.60	0.70	2.7E-08

### 3. LABORATORY TEST RESULTS

#### 3.1 Temporal stability

The AOCU must be switched from *off* to *stand-by* (and *stand-by* to *on*) in less than 10 min. Figure 6 shows the normalised intensity as for a function of time for a number of LED source. The sources have slightly different behaviours, but despite the large initial variations, all sources are stable within <0.5% after only 1 min. After 10 min this value goes below 0.2% for all sources with an average of 0.15%.

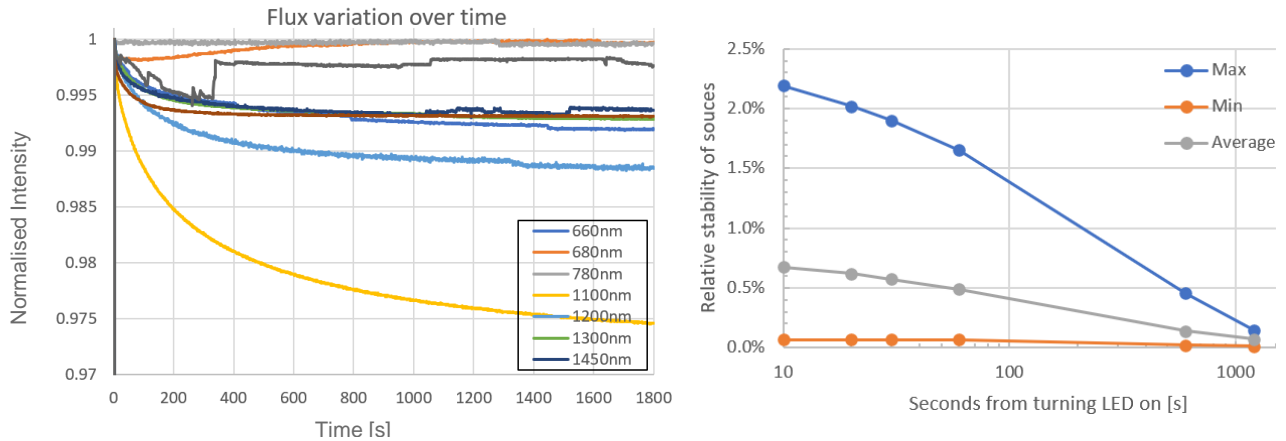

Figure 6: (Left) Normalised intensity as for a function of time for a number of LED sources. (Right) Relative stability of the sources after having them on for a given time (i.e., warm up time).

#### 3.2 Beam combining and monitoring

Multiple light sources are coupling into a single multimode fibre using a 50:50 MM fiber optic coupler (Thorlabs, TM200R5F1B). Figure 7 show the experimental data of the beam combination for different wavelengths. The average transmission is around 21%, ranging from 16% to 25%. The additional losses due to the connection was estimated at 1.4dB, meaning that the transmission inherent to the coupler is closer the 30%. Daisy chaining the coupler further reduces the transmission to around 4.5% in average.

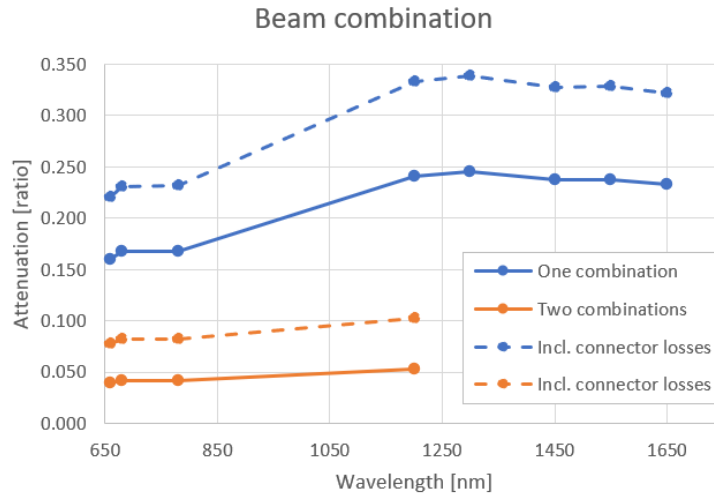

Figure 7: Loss of flux due to beam combination. Blue curve: measured data. Yellow curve: transmission estimation accounting for SAM to FC/PC adaptor connectors losses.

### 3.3 Single mode to multimode coupling

Once the fibres are coupled, the multimode fibre are butt-coupled to a single-mode fibre (i.e., an endlessly single-mode photonic crystal fibre) leading to large losses. The ratio of power between the MM and the SM fibres is given by<sup>6</sup>:

$$\eta = \left( \frac{\pi \cdot D \cdot NA}{\lambda} \right)^2$$

Figure 8 shows the measured attenuation due the coupling between a multimode and single-mode fibre. As shown by the equation above, the attenuation is heavily dependent on the wavelength of the source, ranging approximately from 18000 to 2000 for the longer wavelength. These values are typically 2 to 3 times better than expected by theory (see section 2.4 and Figure 9). The reason for this discrepancy is currently being investigated, but it is believed to be related to the number of modes in the fibre.

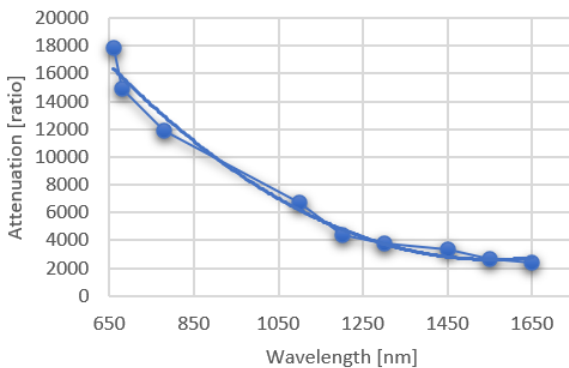

Figure 8: Measured coupling ratio after injection in the single mode fibre with a power trendline.

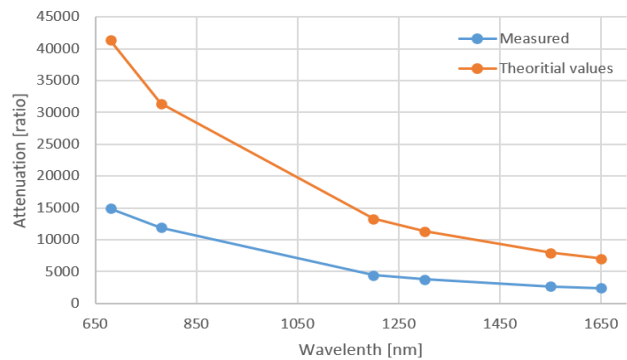

Figure 9: Comparison of the attenuation between theoretical values and measured values.

### 3.4 Complete optical train

Complete optical train as presented Figure 4 is a combination of the attention presented above. The complete setup vastly attenuates the input signal, but with flux levels still above the requirements. Other configurations are possible to minimise losses for some sources.



	680 nm	780 nm	1200 nm	1300 nm	1450nm	1550 nm	1650 nm
Input Power [ $\mu$ W]	179	761	68.8	60.7	117.7	28.2	17.0
Output Power [nW]	1	4.9	1.11	3.85	8	2.18	0.36
Attenuation	180	155	62	15.7	14.7	12.9	47
Min req. [nW]	0.77	1.7	3	9	1	1	3e-3

#### 4. CONCLUSION AND NEXT STEP

In this paper we presented illumination module of the AO calibration unit for HARMONI. These artificial sources can be used to calibrate the HARMONI AO system at any time and assure good performance. We present the whole optical train from the source to the single mode fibre output and associated laboratory test results. In the next step we will focus on trying to simplify the architecture mainly by reducing (combining) the number of sources. This should increase the flux level available for calibrations.

#### ACKNOWLEDGMENTS

HARMONI is an instrument designed and built by a consortium of British, French, and Spanish institutes in collaboration with ESO. This paper describes work that was partially supported by the French national research agency (ANR) under the Future Investment Program (PIA, Programme d'Investissements d'Avenir, PIA) under reference ANR-21-ESRE-008 and the French CSAA program.

#### REFERENCES

- [1] Thatte, N. A., et al., "HARMONI at ELT: Overview of the capabilities and expected performance of the ELT's first light, adaptive optics assisted integral field spectrograph". In Ground-based and Airborne Instrumentation for Astronomy IX, Volume 12184 (2022) <https://doi.org/10.1117/12.2628834>
- [2] Schwartz, N., et al., "Design of the HARMONI Pyramid WFS module," 6th International Conference on Adaptive Optics for Extremely Large Telescopes (2019) <https://doi.org/10.48550/arXiv.2003.07228>
- [3] Bond, Charlotte Z., et al. "HARMONI at ELT: wavefront control in SCAO mode." Adaptive Optics Systems VIII. Vol. 12185. SPIE, 2022 <https://doi.org/10.1117/12.2627713>
- [4] Carlotti, Alexis, et al. "HARMONI at ELT: System analysis and performance estimation of the high-contrast module." Adaptive Optics Systems VIII. Vol. 12185. SPIE, 2022. <https://doi.org/10.1117/12.2628927>
- [5] Neichel, B., et al. "The adaptive optics modes for HARMONI: from Classical to Laser Assisted Tomographic AO." Adaptive optics systems v. Vol. 9909. SPIE, 2016. <https://doi.org/10.1117/12.223168>
- [6] Schwartz N., et al., "HARMONI at ELT: adaptive optics calibration unit from design to prototyping," Proc. SPIE 12185, Adaptive Optics Systems VIII, 121855E (29 August 2022); <https://doi.org/10.1117/12.2627247>