



**HAL**  
open science

# **Estimation of the elastic and piezoelectric tensors of sapphire and lithium niobate from Brillouin light backscattering measurements of a single crystal sample**

Fehima Ugarak, Julio Andrés Iglesias Martinez, Alexis Mosset, Vincent Laude

## ► **To cite this version:**

Fehima Ugarak, Julio Andrés Iglesias Martinez, Alexis Mosset, Vincent Laude. Estimation of the elastic and piezoelectric tensors of sapphire and lithium niobate from Brillouin light backscattering measurements of a single crystal sample. *Journal of Applied Physics*, 2023, 134 (18), pp.185103 (13). <hal-04390691>

**HAL Id: hal-04390691**

**<https://hal.science/hal-04390691v1>**

Submitted on 12 Jan 2024

**HAL** is a multi-disciplinary open access archive for the deposit and dissemination of scientific research documents, whether they are published or not. The documents may come from teaching and research institutions in France or abroad, or from public or private research centers.

L'archive ouverte pluridisciplinaire **HAL**, est destinée au dépôt et à la diffusion de documents scientifiques de niveau recherche, publiés ou non, émanant des établissements d'enseignement et de recherche français ou étrangers, des laboratoires publics ou privés.



HAL Authorization

# Estimation of the elastic and piezoelectric tensors of sapphire and lithium niobate from Brillouin light backscattering measurements of a single crystal sample

Fehima Ugarak, Julio A. Iglesias Martínez, Alexis Mosset, and Vincent Laude  
*Université de Franche-Comté, CNRS, institut FEMTO-ST, F-25000 Besançon, France*

(\*Electronic mail: [vincent.laude@femto-st.fr](mailto:vincent.laude@femto-st.fr))

Brillouin light scattering is a versatile measurement technique of the dispersion of bulk acoustic phonons in amorphous and crystalline solids. It allows contactless and non-destructive characterization of the relevant material tensors of optically transparent materials, provided that the optical refraction indices, and in addition the dielectric tensor for piezoelectric materials, are known beforehand. The complete estimation of the anisotropic material tensors is often performed using many different crystal orientations, and hence different samples of the same crystal. In this paper, we consider the problem of measuring those tensors using a single sample of an anisotropic single crystal with trigonal symmetry. A complete measurement requires sufficient experimental diversity in the phonon wavevectors when sampling the phonon velocity surfaces, hence the consideration of a large number of directions away from crystallographic axes. We estimate all six independent elastic constants of non-piezoelectric sapphire ( $\bar{3}m$  point group) with a single X-cut wafer and the six independent elastic constants together with the four independent piezoelectric constants of piezoelectric lithium niobate ( $3m$  point group) with a single Y-cut wafer. The estimated tensors are in close agreement with those reported in the literature based on resonant ultrasonic techniques.

## I. INTRODUCTION

Ultrasonic properties of solids are described by material tensors entering the constitutive relations of elasticity, piezoelectricity, photoelasticity, and more intricate models<sup>1,2</sup>. Modern design and numerical simulation tools require those material tensors to be known to produce accurate results<sup>3</sup>. Elastic, dielectric, and piezoelectric constants are available in the literature for many solids and were obtained as a result of many experimental studies over the last seventy years. They were obtained using different techniques and show some dispersion in the reported values. In this paper, we focus on two trigonal crystals, non-piezoelectric  $\bar{3}m$  sapphire and piezoelectric  $3m$  lithium niobate, with the goal of estimating all elastic and piezoelectric constants from the non-contact measurement of a single piece of wafer with known orientation.

The reported properties of lithium niobate were obtained using different techniques. O'Brien et al<sup>4</sup> reported elastic and piezoelectric properties obtained using the Brillouin light scattering (BLS) technique for bulk phonons in samples with different orientations oriented along pure crystalline directions. The measurements in the present work also rely on bulk BLS measurements<sup>5-8</sup>, but with a single Y-cut wafer, and rely on a variety of phonon wave vectors to sample the acoustic phonon velocity surfaces. Smith et al<sup>9</sup> performed ultrasonic phase-velocity measurements of the resonances of bar and plate samples. Kovacs et al<sup>10</sup> performed surface acoustic wave (SAW) measurements using a laser Doppler vibrometer and a set of transducers on a single wafer of lithium niobate with  $128^\circ$  rot Y-cut wafer. Ogi et al<sup>11</sup> employed acoustic spectroscopy to characterize the resonances of a single crystal specimen.

As sapphire is not piezoelectric, the electric generation of elastic waves is indirect, via the bonding of an external transducer onto the specimens. Mayer and Hiedemann<sup>12</sup> measured the ultrasonic velocities in a certain crystallographic

direction based on a combination of three optical methods. Wachtman<sup>13</sup> measured the elastic resonances of two rectangular block specimens of corundum (synthetic sapphire) and observed that the values obtained differed from those obtained previously, including early similar investigations by Rao<sup>14</sup> and Bhimasenschar<sup>15</sup> for synthetic and natural sapphire, respectively. Bernstein<sup>16</sup> performed pulse-echo measurements on three sapphire blocks and compared them to resonance measurements on the same samples, obtaining two different but close sets of elastic constants. Gladden et al<sup>17</sup> employed resonant ultrasound spectroscopy to ascertain all independent elastic constants. They found the sign of the elastic constant  $c_{14}$  to be positive, in contrast to previous reports. Hovis et al<sup>18</sup> confirmed this sign using X-ray residual stress measurements. We are unaware of the complete determination of the elastic constants of sapphire using bulk BLS measurements, as we report in this paper with a single X-cut wafer.

BLS<sup>19</sup>, as a non-destructive and contactless characterization technique, enables one to measure the elastic<sup>20-22</sup> and piezoelectric properties<sup>23,24</sup> precisely from the phase velocity of bulk phonons<sup>25,26</sup>, provided optical indices of refraction are known. The measurement of piezoelectric properties further requires knowledge of the low-frequency dielectric tensor. Compared to resonant ultrasonic techniques, the BLS frequencies of bulk acoustic phonons are independent of sample dimensions and boundary conditions. We emphasize that the estimation of the full elastic tensor, for both sapphire and lithium niobate samples, is obtained in this work from a single wafer, whereas conventionally a selection of different, simple crystal orientations is considered<sup>19</sup>. The fitting procedure we use is instead based on the measurement of phonon velocities along a set of different, arbitrary wavevector directions that are not aligned with simple crystallographic directions and that sample the phonon velocity surfaces. For successful estimation of material tensors, it is necessary to have sufficient diversity in the experimental data, so that all independent ten-

tor elements are represented. Considering only a portion of the XY and XZ incidence planes for sapphire, and the YX and YZ incidence planes for lithium niobate, was found to be sufficient in this respect. A comparison with previously reported values for material tensors of sapphire and lithium niobate is presented, both using tables of numerical values and a graphical comparison of measurements with computed phonon velocity surfaces.

## II. METHODS

### A. Experimental setup

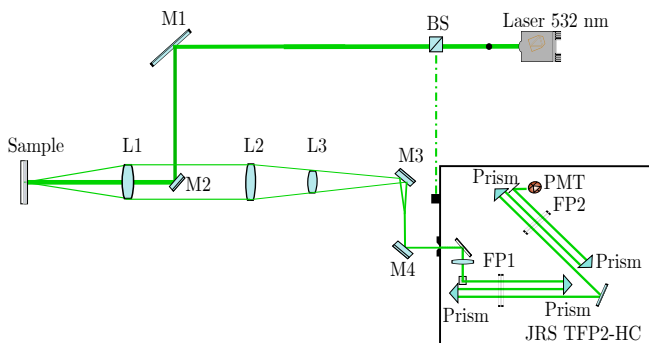

FIG. 1. Setup used for Brillouin light backscattering measurements. BS: beam splitter; M1-M4: mirrors; L1-L3: lenses; FP1: Fabry-Pérot 1; FP2: Fabry-Pérot 2; PMT: Photodetector.

Figure 1 depicts the experimental BLS setup. A longitudinal single-mode laser with a wavelength of  $\lambda_0 = 532$  nm is used as the source of incident photons. The laser provides linearly polarized light (represented with a black dot in Figure 1). The beam splitter splits the beam into two paths. The reference path (dashed line) is used for the alignment and remote control of the Fabry-Pérot interferometers<sup>27</sup>, whereas the main path is used for characterization of the sample.

The power of the main light beam is adjusted with a neutral density filter in order to provide enough backscattered photons while avoiding damage of the sample or saturation of the detector. After reflection on alignment mirrors M1 and M2, the incident laser beam is focused on the sample using lens L1 (focal length  $f_1 = 100$  mm). The spot diameter on the sample is about  $50 \mu\text{m}$ . Backscattered light is collected by the same lens (numerical aperture N.A. = 0.1) and imaged by a manually built Keplerian beam expander including lenses L2 and L3 (focal lengths  $f_2 = 100$  mm and  $f_3 = 30$  mm). Mirrors M3 and M4 are adjusted so that the main light beam enters precisely the entrance pinhole of the Sandercock-type 3+3-pass tandem Fabry-Pérot interferometer (TFP2-HC manufactured by JRS) with the aperture of  $600 \mu\text{m}$  with previously adjusted mirror spacings of 1.5 mm and 2 mm and scanning amplitudes 450 nm for sapphire and 470 nm for lithium niobate, respectively. The total finesse of the tandem Fabry-Pérot interferometer is 100.

The reference beam, with a maximum power of 1 mW,

gives the central line in the spectrum, or Rayleigh scattering elastic peak. A shutter system is inserted in front of the entrance pinhole and switches automatically to the reference signal during the part of the scan that corresponds to the transmission of elastically scattered light. This arrangement avoids a possible overload by the intense elastically scattered light and potential damage to the detector. The very weak signal, produced by the spontaneous inelastic scattering of light by bulk phonons, is filtered with a high contrast ratio ( $>10^9$ ), detected by a synchronized photomultiplier and processed by a multi-channel analyzer with 512 channels (model MCA-1, The Table Stable LTD). Further spectrum analysis is performed using software GHOST 7.00 (The Table Stable LTD).

As the elastic and optical properties of anisotropic materials are angle dependent, the holder of the sample can be rotated to define precisely a direction in 3D space with a homemade (Labview) interface. The incidence angle  $\phi$ , defined in Fig. 2a, is the angle between the incident beam and the normal to the surface of the sample. In addition, the sample can be rotated around the normal to the surface by angle  $\psi$ . The pair  $(\psi, \phi)$  defines the direction of optical incidence with respect to the sample. The backscattering arrangement imposes that the direction of scattered light is colinear with the incident light, and makes an angle  $\pi$  with it<sup>28</sup>. The backscattering arrangement provides a comparably large interaction volume, allowing for a high temporal resolution and Brillouin spectra that are recorded faster compared to other common scattering geometries<sup>29</sup>. The direction and magnitude of the acoustic wavevector  $\mathbf{q}$  are determined by the scattering geometry, which is extremely important in the case of material with preferential directions as in crystals and fibers<sup>22,30-33</sup>.

Conservation of momentum for photons and phonons imposes the phase-matching condition between the interacting waves:

$$\mathbf{q} = \pm(\mathbf{k}_i - \mathbf{k}_s) \quad (1)$$

where  $\mathbf{k}_i$  is the incident wavevector and  $\mathbf{k}_s$  is the scattered wavevector, and the sign distinguishes between Stokes (+) and anti-Stokes (−) phonons. In a purely spontaneous Brillouin process, it is expected statistically that Stokes and anti-Stokes phonons contribute equally to the backscattered signal. In the backscattering configuration  $\mathbf{q} = \pm 2\mathbf{k}_i$  is directly dictated by the incidence direction and the laser wavelength.

### B. Phonon dispersion

In a homogeneous anisotropic material, three acoustic phonons propagate in a given direction and define three closed velocity surfaces. The quasi-longitudinal phonon corresponds mostly to compression-expansion of the medium in the direction of propagation. The other two phonons represent collective shear vibrations that occur mostly perpendicularly to the propagation direction; they are termed quasi-shear phonons<sup>2</sup>. The BLS technique provides frequency shifts in the scattered light that are proportional to the phase velocities of the phonons, provided the photoelastic effect does not vanish. Indeed, the phonon wavevector being imposed by (1), the

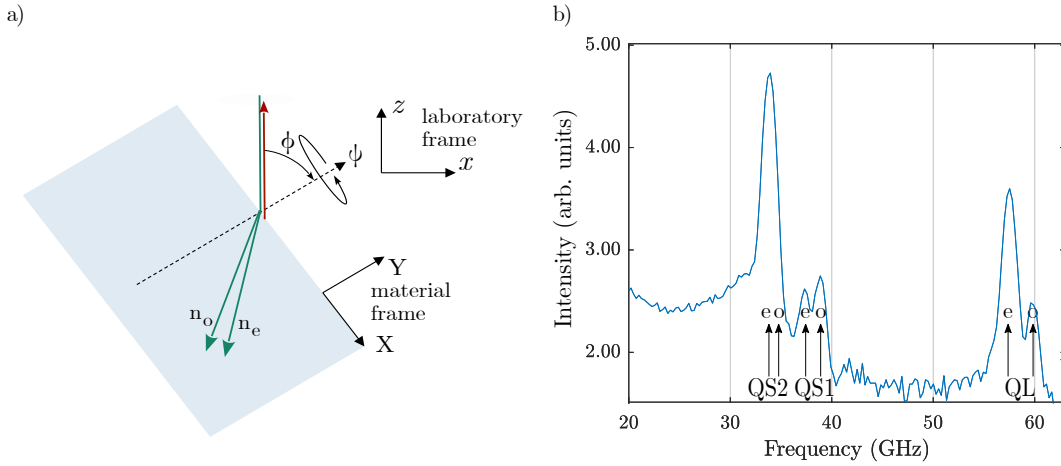

FIG. 2. Brillouin light scattering in birefringent crystals. (a) Angles of rotation for the sample in Brillouin Light backscattering configuration with laboratory and material frame where birefringence implies 2 independent optical modes of propagation (b) BLS response from lithium niobate (cut YX,  $\phi = 2^\circ$ ,  $\psi = 45^\circ$ ) where up to 6 phonon peaks appear (2 for quasi-longitudinal wave (QL), 2 for quasi-shear wave 1 (QS1) and 2 for quasi-shear wave 2 (QS2)).

phonon frequencies are given by the dispersion relation for bulk elastic waves  $\omega = v|\mathbf{q}|$ . In the backscattering configuration,  $\omega/(2\pi) = 2vn/\lambda_0$  with  $n$  the optical index of refraction. The phonon velocities  $v$  can be obtained by solving the Christoffel equation (3) for a harmonic plane wave<sup>34</sup> of the form

$$u_i(t, \mathbf{r}) = \hat{u}_i \exp(i(\omega t - \mathbf{q} \cdot \mathbf{r})) \quad (2)$$

Propagation is directed along normal vector  $\hat{\mathbf{n}} = \mathbf{q}/|\mathbf{q}|$ . The Christoffel equation provides an eigenvalue problem for the square of the velocity in a given direction

$$\Gamma_{il} \hat{u}_l = \rho v^2 \hat{u}_i \quad (3)$$

with  $\rho$  the density of mass. For a non-piezoelectric material, for instance sapphire,  $\Gamma_{il} = c_{ijkl} \hat{n}_j \hat{n}_k$  depends only on the elastic tensor  $c_{ijkl}$ . For a piezoelectric material, for instance, lithium niobate, Christoffel's tensor is modified to

$$\Gamma_{il} = c_{ijkl} \hat{n}_j \hat{n}_k + \frac{\gamma_i \gamma_l}{\epsilon} \quad (4)$$

where  $\gamma_i = e_{kij} \hat{n}_j \hat{n}_k$  and  $\epsilon = \epsilon_{jkl} \hat{n}_j \hat{n}_k$ ;  $e_{kij}$  is the piezoelectric tensor and  $\epsilon_{jkl}$  is the dielectric tensor. Phonon velocities hence depend on the ratio of effective piezoelectric constants to the effective dielectric constant, implying that the latter must be determined otherwise in BLS measurements.

### C. Brillouin Light Scattering in optically birefringent media

Brillouin light scattering is a photon-phonon interaction that occurs within the material under study. We consider two different frames to describe it. The material frame in Fig. 2a is attached to the sample and describes the particular crystal cut. The example depicted is for a Y-cut wafer (the normal to the surface is along the Y crystallographic axis). The laboratory frame is used to describe the orientation of the sample in

space, based on angles  $(\psi, \phi)$ . By definition, axis  $z$  is the incident and backscattering direction and the laser light is linearly polarized along axis  $y$ .

Both sapphire and lithium niobate are negative uniaxial crystals. For lithium niobate<sup>35</sup>, the extraordinary refraction index  $n_e = 2.2320$  and the ordinary refraction index  $n_o = 2.3210$  (for sapphire<sup>36</sup>,  $n_e = 1.7636$  and  $n_o = 1.7717$ ), at  $\lambda_0 = 532$  nm. In a birefringent medium, incident light is decomposed into two refracted ordinary and extraordinary modes of propagation with different refraction angles, as Fig. 2a depicts. As a result, there are at most six different BLS peaks in the response, for two incident photons and three acoustic phonons. The example of Fig. 2b, for Y-cut lithium niobate with  $\phi = 2^\circ$  and  $\psi = 45^\circ$ , shows five different BLS peaks (the ordinary-QS2 peak is not clearly apparent). The difference of ordinary and extraordinary optical indices, or birefringence, is about 5%, leading to a similar separation of the pairs of peaks. In the case of sapphire, the birefringence is less than 0.6% and the ordinary and extraordinary peaks would be hardly distinguishable experimentally, given the frequency resolution of the interferometer.

A wrong classification of ordinary or extraordinary contributions to the BLS spectrum may lead to errors in the estimation of material tensors. For this reason, we consider only optical polarizations along a pure crystallographic axis of the crystal. For Y-cut lithium niobate, the  $y$  axis is either aligned with the  $X$  axis ( $\psi = 0$ ) or with the  $-Z$  axis ( $\psi = \pi/2$ ). For X-cut sapphire, the  $y$  axis is either aligned with the  $Y$  axis ( $\psi = 0$ ) or with the  $Z$  axis ( $\psi = \pi/2$ ). With this arrangement, the optical polarization remains in principle the same as the angle of incidence  $\phi$  is changed.

The relative efficiency of the Brillouin process depends on the photoelastic characteristics. Certain phonon contributions may be absent from the BLS spectra if the photoelastic efficiency vanishes by symmetry or if it is too small in magnitude. As an estimation of this efficiency we use the formula

for spontaneous Brillouin scattering<sup>19</sup>

$$p_{\text{eff}} = p_{ijkl} E_i E_j u_k \frac{q_l}{|\mathbf{q}|} \sqrt{\frac{k_B T}{\rho}} \frac{1}{v} n_{\text{eff}}^3 \quad (5)$$

where  $p_{ijkl}$  is the photoelastic tensor,  $u_k$  are the components of a unit vector describing phonon polarization,  $E_i$  and  $E_j$  are components of unit vectors representing the polarization of the incident and scattered electric fields,  $k_B$  is the Boltzmann constant,  $T$  is the temperature, and  $n_{\text{eff}}$  is the effective optical index (equal either to  $n_o$  or  $n_e$  for optical polarizations along a pure crystallographic axis of the crystal). In practice, the variation of this quantity with the incidence angle is used to check which peaks should be observable in measurements. As a note, photoelastic constants are taken from Ref. 37 for sapphire and Ref. 35 for lithium niobate.

#### D. Estimation of material tensors for trigonal crystals

We wish to estimate from BLS spectra the material tensors, or rather their sets of independent constants. We use in the following the Voigt notation for symmetric pairs of indices,  $I = (ij)$  and  $J = (kl)$ . Trigonal crystals with  $3m$  or  $3m$  point-group symmetry have six independent elastic stiffness coefficients,

$$c_{IJ} = \begin{bmatrix} c_{11} & c_{12} & c_{13} & c_{14} & 0 & 0 \\ c_{12} & c_{11} & c_{13} & -c_{14} & 0 & 0 \\ c_{13} & c_{13} & c_{33} & 0 & 0 & 0 \\ c_{14} & -c_{14} & 0 & c_{44} & 0 & 0 \\ 0 & 0 & 0 & 0 & c_{44} & c_{14} \\ 0 & 0 & 0 & 0 & c_{14} & c_{66} \end{bmatrix} \quad (6)$$

with  $c_{66} = (c_{11} - c_{12})/2$ . For  $3m$  crystals, there are 4 independent piezoelectric constants,

$$e_{iJ} = \begin{bmatrix} 0 & 0 & 0 & 0 & e_{15} & -e_{22} \\ -e_{22} & e_{22} & 0 & e_{33} & 0 & 0 \\ e_{31} & e_{31} & e_{33} & 0 & 0 & 0 \end{bmatrix}. \quad (7)$$

For  $\bar{3}m$  crystals,  $e_{iJ} = 0$  because of centro-symmetry. The dielectric tensor (at low frequencies) has two independent constants

$$\epsilon_{ij} = \begin{bmatrix} \epsilon_{11} & 0 & 0 \\ 0 & \epsilon_{11} & 0 \\ 0 & 0 & \epsilon_{33} \end{bmatrix}. \quad (8)$$

Finally, the optical dielectric tensor is

$$\epsilon_{ij} = \epsilon_0 \begin{bmatrix} n_o^2 & 0 & 0 \\ 0 & n_o^2 & 0 \\ 0 & 0 & n_e^2 \end{bmatrix} \quad (9)$$

with  $n_o$  the ordinary and  $n_e$  the extraordinary indices of refraction.

For non-piezoelectric sapphire, we consider the  $m = 6$  independent elastic constants for the fit against experimental values. For piezoelectric lithium niobate, we add the 4 independent piezoelectric constants, for a total of  $m = 10$  fit variables.

Hence, we consider that the optical and low-frequency dielectric tensors are known beforehand. Actually, optical indices can only be obtained from an optical measurement, independent of the BLS measurement. The low-frequency dielectric tensor, in turn, enters the Christoffel tensor for piezoelectric media, but only as a normalization of the squared piezoelectric effective values, see Eq. (4). The  $m$  fit variables are arranged in a vector  $\mathbf{p}$ .

The number of experimental Brillouin peak frequencies  $f_j$  is  $M$  ( $j = 1, \dots, M$ ). The fitting error that is minimized is

$$E(\mathbf{p}) = \sum_{j=1}^M (f_j - f(\alpha_j, \psi_j, \phi_j; \mathbf{p}))^2 / f_j, \quad (10)$$

where  $(\psi_j, \phi_j)$  are the sampling angles,  $\alpha_j \in \{QL, QS1, QS2\}$  is the classification of the acoustic phonon, and  $f(\alpha, \psi, \phi; \mathbf{p})$  is a function giving the theoretical Brillouin frequencies. The fitting error has units of frequencies (Hz). The Levenberg–Marquardt algorithm is used to obtain the minimum of the error  $E$ , starting from a given initial set of material constants. The standard deviation of each fitted parameter is evaluated as

$$\sigma_i = \sqrt{\frac{E(\mathbf{p}_0)}{DV_p^{-1}[i, i]}}, \quad i = 1, \dots, m \quad (11)$$

where  $E(\mathbf{p}_0)$  is the remaining error at the minimum  $\mathbf{p}_0$ ,  $V_p$  is the Hessian matrix at the minimum, and  $D = M - m + 1$  stands for the number of degrees of freedom. As a note, the standard deviations are indicators for the quality of the fit, expressed in the same physical units as the fitted material parameters.

### III. RESULTS AND DISCUSSION

#### A. X-cut sapphire

Fig. 3 summarizes the experimental data used for sapphire. The particular specimen is a X-cut rectangular wafer (Codex International) with the Y and Z axes aligned with the sides of the rectangle. BLS measurements were performed for varying incidence angle  $\phi$  for  $\psi = 0^\circ$  (XZ incidence plane, ordinary optical polarization) and  $\psi = 90^\circ$  (XY incidence plane, extraordinary optical polarization). Theoretical Brillouin frequencies, obtained for the fitted material constants, are shown with circular markers.

For the XZ plane the phonon frequencies are in theory symmetric with respect to angle  $\phi$ . All three phonons are observed in Fig. 3a and Fig. 3b, though the shear peaks are very small for small values of angle  $\phi$ . The theoretical Brillouin efficiency in Fig. 3c indeed vanishes for  $\phi = 0$  for both shear phonons. Experimentally, the Brillouin efficiency for QS2 appears sufficient for both  $\phi \geq 20^\circ$  and  $\phi \leq -25^\circ$ , but too small for  $\phi \geq 50^\circ$  and  $\phi \leq -55^\circ$ . Similarly, the QS1 peaks appear for  $\phi \geq 20^\circ$  and for  $\phi \leq -25^\circ$ . Overall it appears that there is a threshold on the value of the Brillouin efficiency that must be overcome for the measurements to be significant enough to be kept in the fit process.

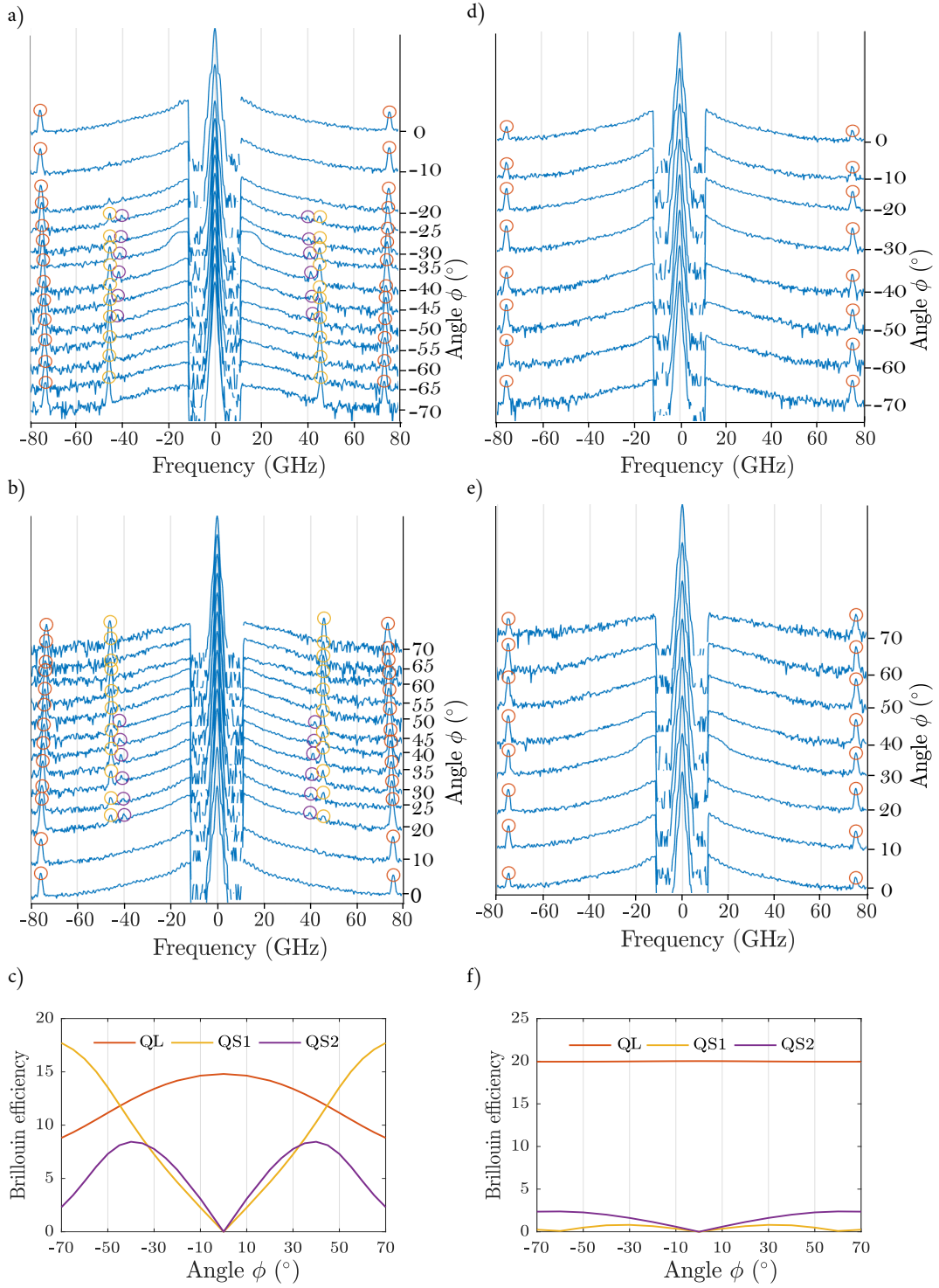

FIG. 3. BLS experimental results for a X-cut sapphire wafer. BLS spectra are shown for the XZ plane for (a) negative and (b) positive values of the angle of incidence  $\phi$ . Theoretical phonon frequencies are shown with circular markers (orange: QL phonon; yellow: QS1 phonon; purple: QS2 phonon). The theoretical photoelastic response is shown in (c) as a function of the angle of incidence  $\phi$ . BLS spectra are shown for the XY plane for (d) negative and (e) positive values of the angle of incidence  $\phi$ . Theoretical phonon frequencies are shown with circular markers (orange: QL phonon; yellow: QS1 phonon; purple: QS2 phonon). The theoretical photoelastic response is shown in (f) as a function of the angle of incidence  $\phi$ .

For the XY plane the phonon frequencies are also in theory symmetric with respect to angle  $\phi$ . The theoretical Brillouin

efficiencies for shear phonons in Fig. 3f remain small for all values of incidence angle  $\phi$ . Thus, only the QL Brillouin data

Elastic Constants (GPa)									
	Rao <sup>14</sup>	Bhimasenachar <sup>15</sup>	Mayer <sup>12</sup>	Wachtman <sup>13</sup>	Bernstein p. <sup>16</sup>	Bernstein r. <sup>16</sup>	Gladden <sup>17</sup>	Hovis <sup>18</sup>	BLS
$c_{11}$	466.0	465.0	496.0	496.8	490.2	492.0	497.5	497.0	$511.90 \pm 0.21$
$c_{12}$	127.0	124.0	109.0	163.6	165.4	168.4	162.7	163.0	$166.65 \pm 0.99$
$c_{13}$	117.0	117.2	48.0	110.9	113.0	116.4	115.5	116.0	$123.14 \pm 1.24$
$c_{33}$	506.0	563.0	502.0	498.1	490.2	492	503.3	501.0	$522.54 \pm 3.25$
$c_{44}$	235.3	233.0	206.0	147.48	145.45	146.8	147.4	147.0	$150.89 \pm 0.68$
$c_{14}$	9.4	101.0	38.0	-23.5	-23.2	-23.4	22.5	22.0	$23.42 \pm 0.15$
Remaining fit error (GHz)									0.0111

TABLE I. Independent material constants for sapphire, taken from the literature<sup>12,14–18</sup> and obtained by fitting BLS measurements. Bernstein p. and r. stand respectively for Bernstein pulse-echo and resonance measurements.

for the XY plane were used for the fit.

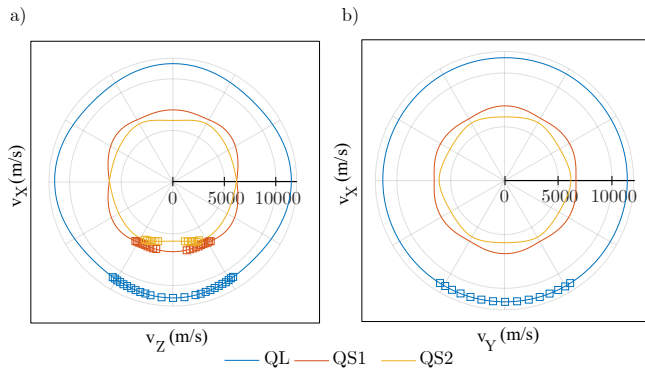

FIG. 4. Velocity curves for X-cut sapphire are shown for (a) the XZ plane and (b) the XY plane. Experimental velocities obtained with BLS are shown with markers. Solid lines are for theoretical velocity curves obtained from the fitted material constants.

The fitted elastic constants are listed in the last column of Tab. I, together with the standard deviations. Fig. 4 shows the phonon velocity curves in the XZ and the XY planes, together with the experimental velocities used for the fit. The quality of the fit is visually quite good, in the sense that the velocity curves match well with experimental points. The remaining fit error is 11.1 MHz.

Fig. 5 shows the velocity curves in the XZ and XY planes computed with the different sets of elastic constants summarized in Tab. I. The purpose is here to compare directly BLS experimental results with those curves that are indeed quite sensitive to the values of the elastic constants. The complete set of six independent elastic constants was first reported by Rao<sup>14</sup> for synthetic sapphire and then by Bimasenachar<sup>15</sup> for natural sapphire, who obtained similar values except for  $c_{33}$ . Those early results are quite far from our results for sapphire. Mayer and Hiedemann<sup>12</sup> redetermined the elastic constants for synthetic sapphire, obtaining rather different results, that remain however still far from our BLS results. The findings of Wachtman<sup>13</sup> and Bernstein<sup>16</sup> align well with the results presented in this paper, based on BLS. However, the more recent experiments conducted by Gladden et al<sup>17</sup> and Hovis et al<sup>18</sup> exhibit an even better agreement with our measurements. The most important distinction lies in the sign of the elastic constant  $c_{14}$ . We checked the effect of setting the sign of the

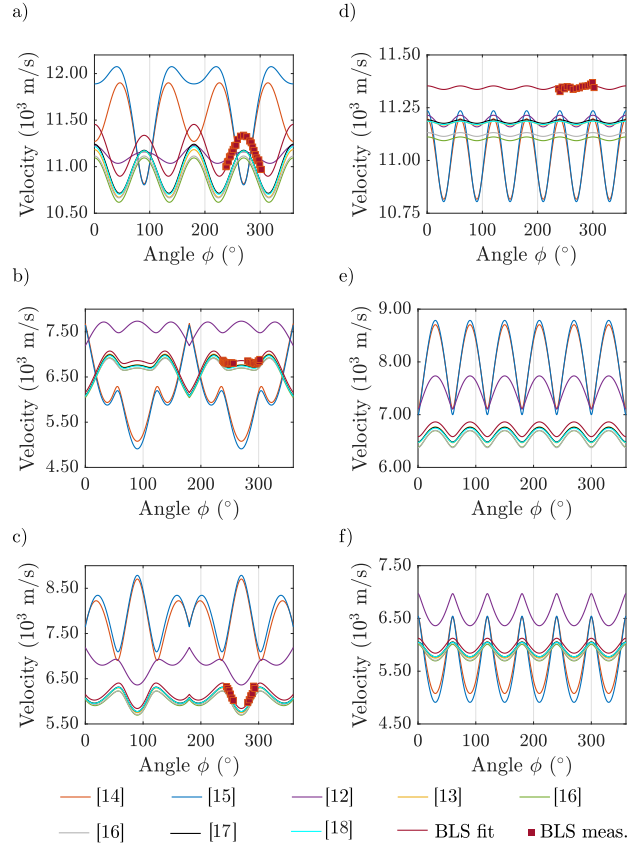

FIG. 5. Comparison of experimental phonon velocities to different sets of materials constants for sapphire. Velocity curves are shown with solid lines for the XZ plane for (a) the QL phonon (b) the QS1 phonon and (c) the QS2 phonon, and for the XY plane for (d) the QL phonon (e) the QS1 phonon and (f) the QS2 phonon. They were obtained for the sets of materials constants listed in Table I. The green line indicates Bernstein pulse-echo and the gray line Bernstein resonance measurements. Experimental velocities are shown with markers.

starting value for  $c_{14}$  (with all 6 equivalent constants being flipped together): the fitting results are obtained exactly with the same error and standard deviations. Furthermore, the sign of  $c_{14}$  never changes during optimization. Hence we conclude that we can only find the modulus of  $c_{14}$  with the incidence planes we considered, but not its sign.

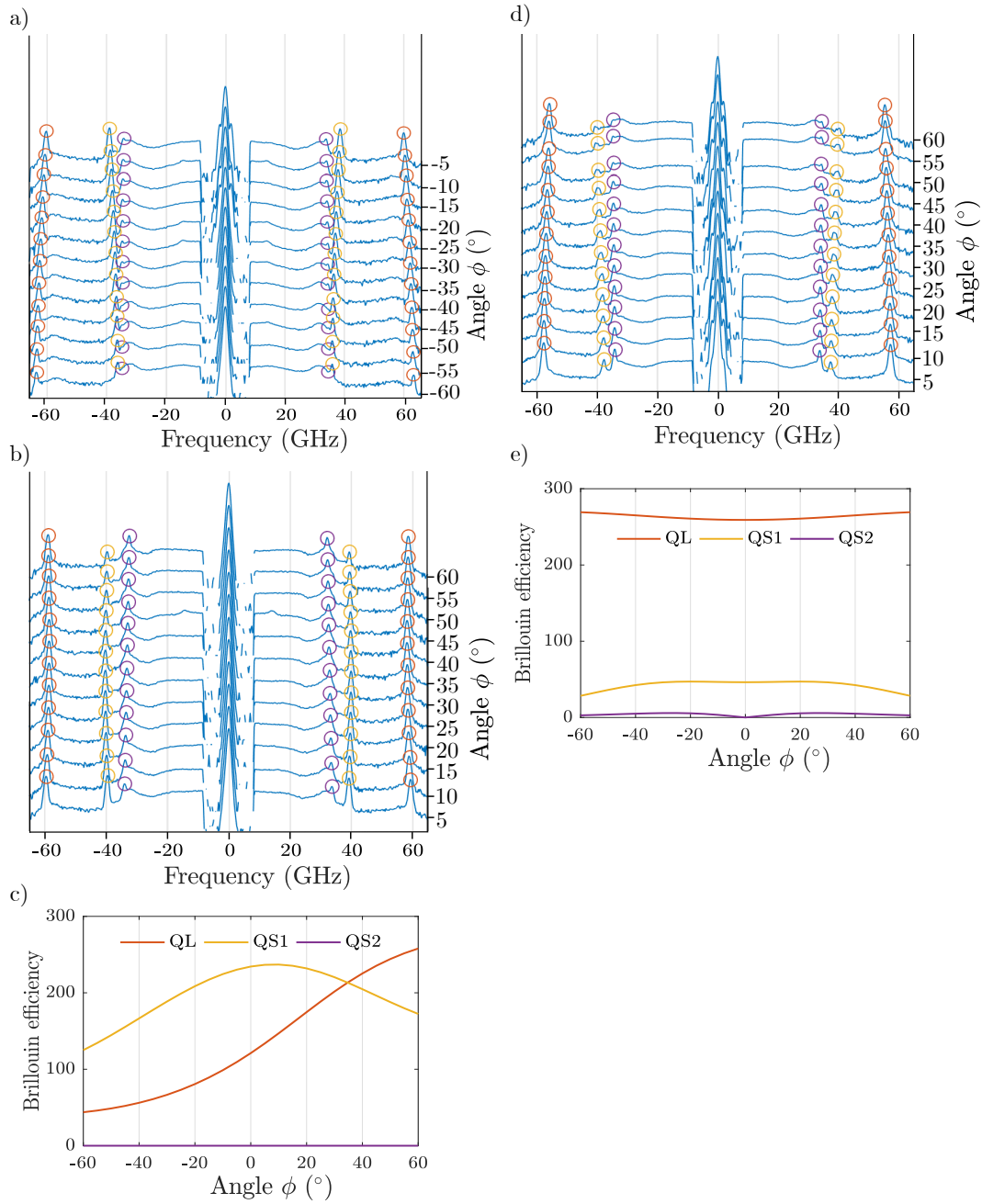

FIG. 6. BLS experimental results for a Y-cut lithium niobate wafer. BLS spectra are shown for the YZ plane for (a) negative and (b) positive values of the angle of incidence  $\phi$ . Theoretical phonon frequencies are shown with circular markers (orange: QL phonon; yellow: QS1 phonon; purple: QS2 phonon). The theoretical photoelastic response is shown in (c) as a function of the angle of incidence  $\phi$ . BLS spectra are shown for the YX plane for (d) positive values of the angle of incidence  $\phi$ . Theoretical phonon frequencies are shown with circular markers (orange: QL phonon; yellow: QS1 phonon; purple: QS2 phonon). The theoretical photoelastic response is shown in (e) as a function of the angle of incidence  $\phi$ .

## B. Y-cut lithium Niobate

Fig. 6 summarizes the experimental data used for lithium niobate. The particular specimen is a rectangular unpoled Y-cut wafer (Roditi) with the X axis and Z axis aligned with the sides of the rectangle. Measurements are presented for varying incidence angle  $\phi$  for  $\psi = 90^\circ$  (YZ incidence plane, or-

dinary optical polarization) and  $\psi = 0^\circ$  (YX incidence plane, extraordinary optical polarization). Theoretical Brillouin frequencies, obtained for the fitted material constants, are shown with circular markers.

For the YZ plane the phonon frequencies are not symmetric with respect to angle  $\phi$ ; negative  $\phi$  values are grouped in Fig. 6a whereas positive values are grouped in Fig. 6b. All

three phonons are observed for all values of angle  $\phi$ . The theoretical Brillouin efficiency in Fig. 6c is relatively large for phonons QL and QS1 but vanishes for QS2 for all incidence angles, as a result of the symmetry of the photoelastic tensor. There is thus a discrepancy that must be accounted for. Alternatively, we made the hypothesis that the polarizer is not perfect but possesses a finite contrast ratio. Hence it is possible that the polarization of light is not perfectly aligned with the X axis of the crystal but there is some part orthogonal to it. Since the photoelastic efficiency for extraordinary optical polarization is large, we thus assume that the QS2 frequency peaks are obtained for extraordinary index  $n_e$  and not for ordinary index  $n_o$ . In the fit, experimental QS2 frequencies were thus multiplied by a factor  $n_o/n_{\text{eff}}$ , where  $n_{\text{eff}} = \sqrt{n_e^2 + (1 - (n_e/n_o)^2) \sin^2(\phi)}$ , to account for this misclassification. As a note, the wavevector direction for the QS2 phonon also changes when the extraordinary wave is used for the interpretation instead of the ordinary wave, but the variation with  $\phi$  is very small and was neglected.

For the YX plane, the phonon frequencies are in theory symmetric with angle  $\phi$ ; only positive values were measured and are shown in Fig. 3d. The theoretical Brillouin efficiencies for both QL and QS1 phonons in Fig. 6e are large, but the values for the QS2 phonons remain rather small for all values of incidence angle  $\phi$ . They were however deemed sufficient and were kept in the fit process.

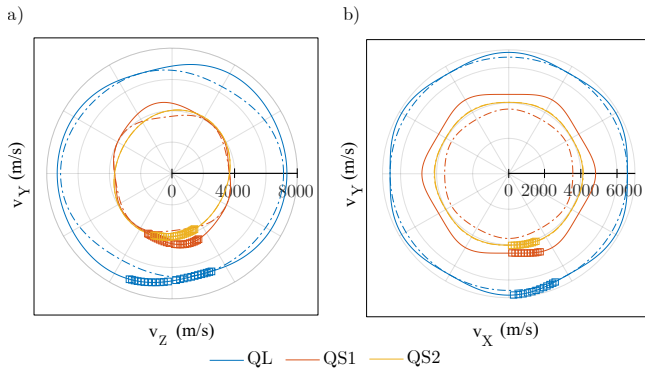

FIG. 7. Velocity curves for Y-cut lithium niobate are shown for (a) the YZ plane and (b) the YX plane. Experimental velocities obtained with BLS are shown with markers. Solid lines are for theoretical velocity curves obtained from the fitted material constants. The dotted lines are for theoretical velocity curves obtained similarly but ignoring piezoelectricity.

The fitted elastic and piezoelectric constants are listed in the last column of Tab. II, together with the standard deviations. Fig. 7 shows the phonon velocity curves in the YZ and the YX planes, together with the experimental velocities used for the fit. The quality of the fit is visually very good, in the sense that the velocity curves match well with experimental points. The remaining fit error is 5.2 MHz.

Fig. 8 shows the velocity curves in the YZ and YX planes computed with the different sets of elastic and piezoelectric constants summarized in Tab. II. The purpose is here to compare directly BLS experimental results with those curves.

Measuring the ten independent coefficients  $c_{IJ}$  and  $e_{iJ}$  may

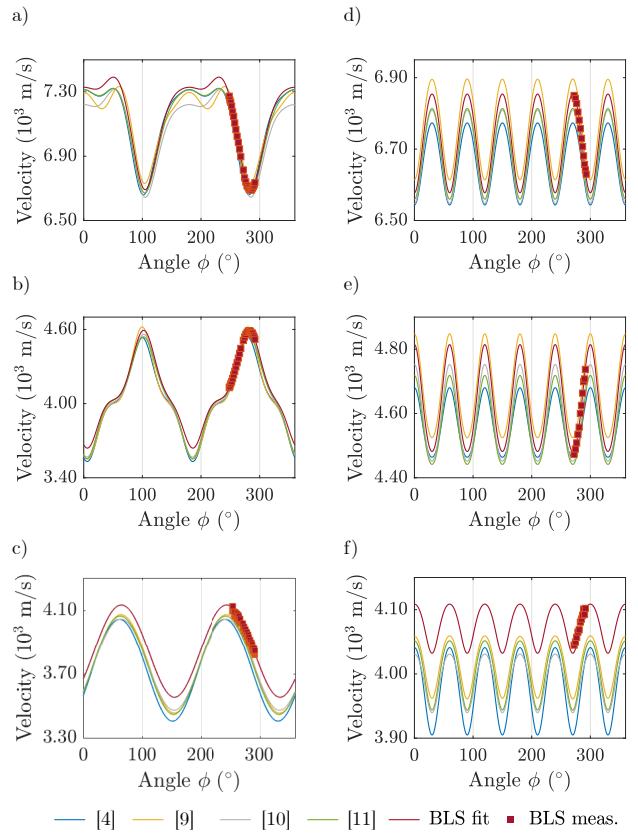

FIG. 8. Comparison of experimental phonon velocities to different sets of materials constants for lithium niobate. Velocity curves are shown with solid lines for the YZ plane for (a) the QL phonon (b) the QS1 phonon and (c) the QS2 phonon, and for the YX plane for (d) the QL phonon (e) the QS1 phonon and (f) the QS2 phonon. They were obtained for the sets of materials constants listed in Table II. Experimental velocities are shown with markers.

appear a difficult task, especially when using a single wafer or crystal cut. O'Brien<sup>4</sup> reported a BLS study in a single crystal of ferroelectric lithium niobate. Experiments were performed using a high-resolution grating spectrograph (in 90°-scattering geometry) and considering different simple orientations of the specimen to be able to obtain the full elastic and piezoelectric tensors. Compared to the nonlinear least-square fit procedure, considering pure phonon modes simplifies the Christoffel tensor and orthogonalizes the estimation of the different tensor elements. The four phonon directions (100), (010), (001) and (011) provided 11 frequency measurements for 10 independent constants. The values obtained by O'Brien are consistent with ours.

Afterwards, Smith and Welsh<sup>9</sup> showed that a complete set of coefficients can be obtained from ultrasonic phase velocity measurements coupled with low-frequency capacitance measurements for the dielectric coefficients. They mentioned that this approach sometimes fails and that then one must measure the electromechanical coupling factor and the natural frequencies of resonating bars. Only six from ten coefficients result from direct measurements. To solve all necessary equations Smith and Welsh observed that it is inevitable

Elastic Constants (GPa)					
	O'Brien <sup>4</sup>	Smith <sup>9</sup>	Kovacs <sup>10</sup>	Ogi <sup>11</sup>	BLS
$c_{11}$	201.25	203.0	198.39	199.5	200.24 ± 0.12
$c_{12}$	57.91	53.0	54.72	55.27	49.75 ± 0.12
$c_{13}$	71.08	75.2	65.13	67.67	67.98 ± 0.57
$c_{33}$	240.10	242.4	227.9	235.0	234.24 ± 2.90
$c_{44}$	59.63	59.5	59.65	59.48	62.20 ± 0.30
$c_{14}$	9.43	8.5	7.88	8.70	7.98 ± 0.06
Remaining fit error (GHz)					0.0052
Piezoelectric Constants (C/m <sup>2</sup> )					
$e_{15}$	3.705	3.76	3.69	3.65	3.62 ± 0.02
$e_{22}$	2.264	2.43	2.42	2.39	2.50 ± 0.01
$e_{31}$	0.53	0.23	0.30	0.31	0.28 ± 0.03
$e_{33}$	1.71	1.33	1.77	1.72	1.83 ± 0.13
Dielectric Constants ( $\epsilon_0$ )					
$\epsilon_{11}$	44	42.58	45.6	45.05	45.6 <sup>†</sup>
$\epsilon_{33}$	29	42.8	26.3	26.2	26.3 <sup>†</sup>

TABLE II. Independent material constants for lithium niobate, taken from the literature<sup>4,9-11</sup> and obtained by fitting BLS measurements with fixed dielectric constants<sup>†</sup> taken from Ref. 10.

to perform many measurements on many crystals with many orientations<sup>9</sup>.

The characterization of linear elastic, piezoelectric, and dielectric material constants is very important for the fabrication of SAW devices. It can be obtained from precise SAW velocity measurements on a single crystal orientation using a non-linear least squares algorithm, if the SAW velocity of the chosen crystal cut is sensitive to all material constants. Kovacs et al argued that this is the case for 128°-rotated Y-lithium niobate<sup>10</sup>. They measured SAW velocities by scanning the crystal surface with a laser vibrometer along several parallel lines and applying the angular spectrum of waves theory.

Finally, Ogi et al<sup>11</sup> proposed a method that yields all ten elastic and piezoelectric coefficients with a single frequency sweep on a single mono-crystal specimen by using acoustic spectroscopy, often called resonance-ultrasound spectroscopy. They identified almost all observed 56 resonance modes by measuring the displacement distributions on a surface using laser-Doppler interferometry. They also mention that the change in elastic stiffness of piezoelectric materials is caused by the dependent combination of piezoelectric and dielectric coefficients, thereby mechanical spectroscopy can not be used for their separate measurements. This property is also present with BLS measurements. Resonance-ultrasound spectroscopy is very sensitive to the dimensions of the sample and to boundary conditions, limitations that are not present with bulk BLS measurements.

Summarizing, performing BLS measurements on a lithium niobate Y-cut wafer and using a fitting procedure (with an initial guess for the constants), we were able to estimate the full elastic and piezoelectric tensors with high fit confidence. The technique is contactless and non destructive. It requires prior knowledge of the optical indices of refraction and of the low-frequency dielectric constants. From the obtained set of constants, one can notice that our value for  $c_{12}$  is lower compared to previously reported values whereas the value for  $c_{44}$  is comparatively larger. Regarding piezoelectric constants, the val-

ues we obtain are closest to those of Kovacs et al<sup>10</sup> and Ogi et al<sup>11</sup>.

#### IV. CONCLUSION

Brillouin light scattering allows one to estimate the elastic tensor of an anisotropic crystal given prior information on the crystal class and on the optical indices of refraction, and on the dielectric tensor at low frequency for piezoelectric crystals. In this paper, we have reported measurements on two anisotropic media with trigonal crystal symmetry: non-piezoelectric sapphire ( $\bar{3}m$  point group) and piezoelectric lithium niobate ( $3m$  point group). Implementing a general fitting procedure to the velocity surfaces for acoustic phonons, we have obtained all six independent elastic-stiffness coefficients of sapphire with a single X-cut wafer, and all six elastic and four piezoelectric coefficients of lithium niobate with a single Y-cut wafer. Standard deviations are small, indicating that confidence in the estimated tensor values is high and that the velocity surfaces can be fitted assuming only crystal symmetry. For the complete estimation of an independent tensor elements, a photoelastic signal for all three acoustic phonons, or elastic waves, is required. Finally, these results were compared to those reported in the literature using ultrasonic means or BLS. We found the best agreement with values obtained by Gladden et al<sup>17</sup> for sapphire and by Ogi et al<sup>11</sup> for lithium niobate. Extension of the technique to other crystal cuts and compositions is straightforward.

#### ACKNOWLEDGMENTS

We gratefully acknowledge Sarah Benchabane-Gaiffe and Quentin Micard for generously providing us with lithium niobate and sapphire wafers, and Jean-Marc Côte for help with automatizing the experimental set-up. This work was sup-

ported by the french RENATECH network and its FEMTO-ST technological facility, the EIPHI Graduate School [grant number ANR-17-EURE-0002], and Région Bourgogne-Franche-Comté.

## AUTHOR DECLARATIONS

The authors have no conflicts to disclose.

## DATA AVAILABILITY

The data that support the findings of this study are available from the corresponding author upon reasonable request.

- <sup>1</sup>A. Authier, *International Tables for Crystallography*, edited by A. Authier, Vol. D: Physical properties of crystals (Kluwer Academic Publishers, 2006) Chap. 1.1. Introduction to the properties of tensors, p. 3–33.
- <sup>2</sup>D. Royer and E. Dieulesaint, *Elastic waves in solids* (Wiley, New York, 1999).
- <sup>3</sup>A. O. Krushynska, D. Torrent, A. M. Aragón, R. Ardito, O. R. Bilal, B. Bonello, F. Bosia, Y. Chen, J. Christensen, A. Colombi, *et al.*, “Emerging topics in nanophononics and elastic, acoustic, and mechanical metamaterials: an overview,” *Nanophotonics* **12**, 659–686 (2023).
- <sup>4</sup>R. O’Brien, G. Rosasco, and A. Weber, “Brillouin scattering in lithium niobate,” in *Light Scattering Spectra of Solids: Proceedings of the International Conference held at New York University, New York, September 3–6, 1968* (Springer, 1969) pp. 623–630.
- <sup>5</sup>F. Scarponi, S. Mattana, S. Corezzi, S. Caponi, L. Comez, P. Sassi, A. Morresi, M. Paolantoni, L. Urbanelli, C. Emiliani, *et al.*, “High-performance versatile setup for simultaneous Brillouin-Raman microspectroscopy,” *Physical Review X* **7**, 031015 (2017).
- <sup>6</sup>G. Carlotti, “Elastic characterization of transparent and opaque films, multilayers and acoustic resonators by surface Brillouin scattering: a review,” *Applied Sciences* **8**, 124 (2018).
- <sup>7</sup>F. Kargar and A. A. Balandin, “Advances in Brillouin–Mandelstam light-scattering spectroscopy,” *Nature Photonics* **15**, 720–731 (2021).
- <sup>8</sup>O. Florez, G. Arregui, M. Albrechtsen, R. Ng, J. Gomis-Bresco, S. Stobbe, C. Sotomayor-Torres, and P. D. García, “Engineering nanoscale hypersonic phonon transport,” *Nature Nanotechnology* **17**, 947–951 (2022).
- <sup>9</sup>R. Smith and F. Welsh, “Temperature dependence of the elastic, piezoelectric, and dielectric constants of lithium tantalate and lithium niobate,” *Journal of applied physics* **42**, 2219–2230 (1971).
- <sup>10</sup>G. Kovacs, M. Anhorn, H. Engan, G. Visintini, and C. Ruppel, “Improved material constants for LiNbO<sub>3</sub> and LiTaO<sub>3</sub>,” in *IEEE Symposium on Ultrasonics* (IEEE, 1990) pp. 435–438.
- <sup>11</sup>H. Ogi, Y. Kawasaki, M. Hirao, and H. Ledbetter, “Acoustic spectroscopy of lithium niobate: elastic and piezoelectric coefficients,” *Journal of Applied Physics* **92**, 2451–2456 (2002).
- <sup>12</sup>W. G. Mayer and E. Hiedemann, “Optical methods for the ultrasonic determination of the elastic constants of sapphire,” *The Journal of the Acoustical Society of America* **30**, 756–760 (1958).
- <sup>13</sup>J. B. Wachtman Jr, W. E. Tefft, D. G. Lam Jr, and R. P. Stinchfield, “Elastic constants of synthetic single crystal corundum at room temperature,” *Journal of Research of the National Bureau of Standards. Section A, Physics and Chemistry* **64**, 213 (1960).
- <sup>14</sup>R. V. G. Sundara Rao, “Elastic constants of alumina,” *Proceedings of the Indian Academy of Sciences, Section A* **29**, 352 (1949).
- <sup>15</sup>J. Bhimasenachar, “Elastic constants of corundum,” *Current Science* **18**, 372–373 (1949).
- <sup>16</sup>B. T. Bernstein, “Elastic constants of synthetic sapphire at 27°C,” *Journal of Applied Physics* **34**, 169–172 (1963).
- <sup>17</sup>J. R. Gladden, J. H. So, J. D. Maynard, P. W. Saxe, and Y. Le Page, “Reconciliation of ab initio theory and experimental elastic properties of Al<sub>2</sub>O<sub>3</sub>,” *Applied Physics Letters* **85**, 392–394 (2004).
- <sup>18</sup>D. B. Hovis, A. Reddy, and A. H. Heuer, “X-ray elastic constants for  $\alpha$ -Al<sub>2</sub>O<sub>3</sub>,” *Applied Physics Letters* **88** (2006), 10.1063/1.2189071.
- <sup>19</sup>R. Vacher and E. Courtens, *International tables for crystallography*, edited by A. Authier, Vol. D: Physical properties of crystals (Kluwer Academic Publishers, 2006) Chap. 2.4. Brillouin scattering, p. 329–335.
- <sup>20</sup>S. T. Bailey, M. D. Twa, J. C. Gump, M. Venkiteshwar, M. A. Bullimore, and R. Sooryakumar, “Light-scattering study of the normal human eye lens: elastic properties and age dependence,” *IEEE Transactions on Biomedical Engineering* **57**, 2910–2917 (2010).
- <sup>21</sup>D. Faurie, N. Girodon-Boulandet, A. Kaladjian, F. Challali, G. Abadias, and P. Djemia, “Setup for high-temperature surface Brillouin light scattering: Application to opaque thin films and coatings,” *Review of Scientific Instruments* **88**, 023903 (2017).
- <sup>22</sup>M. Grimsditch and A. Ramdas, “Brillouin scattering in diamond,” *Physical Review B* **11**, 3139 (1975).
- <sup>23</sup>J. Liu and Y.-J. Jiang, “Brillouin scattering study on elastic and piezoelectric properties of laser irradiated ZnO single crystals,” *Chinese Physics B* **19**, 116201 (2010).
- <sup>24</sup>D. Shuo, Z. Yong, L. Yu-Long, G. Siu, C. Lee, and J. Yi-Jian, “Elastic and piezoelectric properties of Ce:BaTiO<sub>3</sub> single crystals,” *Chinese Physics Letters* **22**, 1790 (2005).
- <sup>25</sup>A. B. Singaraju, D. Bahl, and L. L. Stevens, “Brillouin light scattering: development of a near century-old technique for characterizing the mechanical properties of materials,” *AAPS PharmSciTech* **20**, 1–16 (2019).
- <sup>26</sup>Z. Meng, T. Thakur, C. Chitrakar, M. K. Jaiswal, A. K. Gaharwar, and V. V. Yakovlev, “Assessment of local heterogeneity in mechanical properties of nanostructured hydrogel networks,” *ACS Nano* **11**, 7690–7696 (2017).
- <sup>27</sup>R. Mock, B. Hillebrands, and J. R. Sandercock, “Construction and performance of a Brillouin scattering set-up using a triple-pass tandem Fabry-Perot interferometer,” *Journal of Physics E: Scientific Instruments* **20**, 656 (1987).
- <sup>28</sup>F. Palombo and D. Fioretto, “Brillouin light scattering: applications in biomedical sciences,” *Chemical reviews* **119**, 7833–7847 (2019).
- <sup>29</sup>M. Philipp, U. Müller, R. Sanctuary, P. Seck, and J.-K. Krüger, “Scanning Brillouin microscopy: acoustic microscopy at gigahertz frequencies,” *Archives des Sciences Naturelles, Physiques et Mathématiques* (2012).
- <sup>30</sup>R. J. J. Rioboó, N. Gontán, D. Sanderson, M. Desco, and M. V. Gómez-Gavro, “Brillouin spectroscopy: From biomedical research to new generation pathology diagnosis,” *International Journal of Molecular Sciences* **22**, 8055 (2021).
- <sup>31</sup>D. Kajewski, S. Oh, J.-H. Ko, A. Majchrowski, A. Bussmann-Holder, R. Sitko, and K. Roleder, “Brillouin light scattering in niobium doped lead zirconate single crystal,” *Scientific Reports* **12**, 13066 (2022).
- <sup>32</sup>L. La Spina, Q. Micard, A. Mosset, S. Margueron, A. Bartaszyte, and V. Laude, “Dispersion of surface elastic waves on Z-LiNbO<sub>3</sub> films on Z-sapphire,” *Applied Physics Letters* **122**, 172202 (2023).
- <sup>33</sup>K. Shemer, G. Bashan, E. Zehavi, H. H. Diamandi, A. Bernstein, K. Sharma, Y. London, D. Barrera, S. Sales, A. Bergman, *et al.*, “Optical fiber point sensors based on forward Brillouin scattering,” *Optics Express* **30**, 39321–39328 (2022).
- <sup>34</sup>V. Laude, *Phononic Crystals: Artificial Crystals for Sonic, Acoustic, and Elastic Waves*, 2nd ed. (De Gruyter, Berlin, 2020).
- <sup>35</sup>R. Weis and T. Gaylord, “Lithium niobate: Summary of physical properties and crystal structure,” *Applied Physics A* **37**, 191–203 (1985).
- <sup>36</sup>A. C. DeFranzo and B. G. Pazol, “Index of refraction measurement on sapphire at low temperatures and visible wavelengths,” *Applied Optics* **32**, 2224–2234 (1993).
- <sup>37</sup>R. M. Waxler and E. N. Farabaugh, “Photoelastic constants of ruby,” *Journal of Research of the National Bureau of Standards. Section A, Physics and Chemistry* **74**, 215 (1970).