



HAL
open science

Assessing the relative impacts of maximum investment rate and temporal detail in capacity expansion models applied to power systems

Thomas Heggarty, Jean-Yves Bourmaud, Robin Girard, Georges Kariniotakis

► To cite this version:

Thomas Heggarty, Jean-Yves Bourmaud, Robin Girard, Georges Kariniotakis. Assessing the relative impacts of maximum investment rate and temporal detail in capacity expansion models applied to power systems. *Energy*, 2024, 290, pp.130231. 10.1016/j.energy.2024.130231 . hal-04383397

HAL Id: hal-04383397

<https://hal.science/hal-04383397>

Submitted on 9 Jan 2024

HAL is a multi-disciplinary open access archive for the deposit and dissemination of scientific research documents, whether they are published or not. The documents may come from teaching and research institutions in France or abroad, or from public or private research centers.

L'archive ouverte pluridisciplinaire **HAL**, est destinée au dépôt et à la diffusion de documents scientifiques de niveau recherche, publiés ou non, émanant des établissements d'enseignement et de recherche français ou étrangers, des laboratoires publics ou privés.

Assessing the relative impacts of maximum investment rate and temporal detail in capacity expansion models applied to power systems

Thomas Heggarty^{a,b,*}, Jean-Yves Bourmaud^a, Robin Girard^b, Georges Kariniotakis^b

^a*Réseau de Transport d'Electricité, La Défense, France* ^b*Mines Paris, PSL University, Center for processes, renewable energies and energy systems (PERSEE), Sophia-Antipolis, France.* *Corresponding author.

Abstract

Capacity expansion models provide the basis on which to decide where, when, how much and what technology type to deploy. In systems with large shares of variable renewable energy, the low temporal detail of these models has been shown to introduce biases, prompting much recent work to reduce them. This paper shows that this issue is fairly secondary compared to the impact of maximum investment rates. Through this parameter, typically not discussed in capacity expansion studies, many notions can collectively be expressed, such as the rate at which capacity is financed, institutions approve development, manufacturers roll-out equipment, civil engineers build infrastructure, network operators connect plants etc. This paper shows that considering even ambitious development rates significantly increases total system costs, and drastically changes the structure of an optimal generation mix. The presented sensitivity analysis is based on a multi-region representation of the European power system, modelled using the open-source tool OSeMOSYS, to which a novel power transmission module has been added. Results stress the extent to which hopes of meeting climate targets hinge on society's collective ability to deploy new low-carbon infrastructure fast enough. Energy policy can enhance this ability by providing long-term visibility and stability, reducing investment risk.

Keywords: Capacity expansion planning, maximum investment rate, optimal investment pathways, brownfield study, climate targets.

1. Introduction

The current technology-focussed approach to reducing greenhouse gas emissions requires a complete restructuring of the energy system. These systems are composed of capital intensive assets with lifetimes in the order of decades; poor planning can hence lead to costly lock-in effects, not just from an economic standpoint, but social and environmental also, as these assets have far-reaching impacts. To manage such risks, policy makers are typically guided by model-based analyses, most notably from Capacity Expansion Models (CExM)¹, whose task it is to determine where, when, how much and what technology type should be built or retired to meet all three components of the energy trilemma (energy security, energy equity, environmental sustainability).

Using these models requires expertise. Their number of parameters and variables typically reach several dozens, many of which can single-handedly significantly affect key model outputs. Moreover, due to the size of the problem to be solved, these models must make simplifying assumptions, typically restricting sectoral, spatial and temporal resolutions. To ensure simplifications are compatible with a specific research question, heavy use of sensitivity analysis is required, along with transparency in the way parameters are set. The following sub-sections discuss how previous work has evaluated the impact of two different model features: temporal detail, and maximum investment rates.

1.1. Reviewing the impact of temporal detail

Many CExMs have been proposed by academics, institutions and companies alike, as reviewed by several papers such as Ringkjøb *et al.* [4], Connolly *et al.* [5] and Oree *et al.* [6]. The most widely used of these models² have fairly similar structures, particularly where their limited temporal resolution is concerned, has lead to the same biases being observed in their outcomes when large shares of Variable Renewable Energy (VRE) are considered. As summarised in Figure 1, these biases are the consequence of poor representation of flexibility *i.e.* a system's ability to cope with variability and

¹This corresponds to the terminology used by the International Energy Agency [1], other authors may use the terms Energy System Optimisation Model [2] or long-term energy system models [3] to refer to similar concepts.

²*E.g.* TIMES [7], MESSAGE [8], PRIMES [9], OSeMOSYS [10].

uncertainty, both in terms of its requirement and its provision.

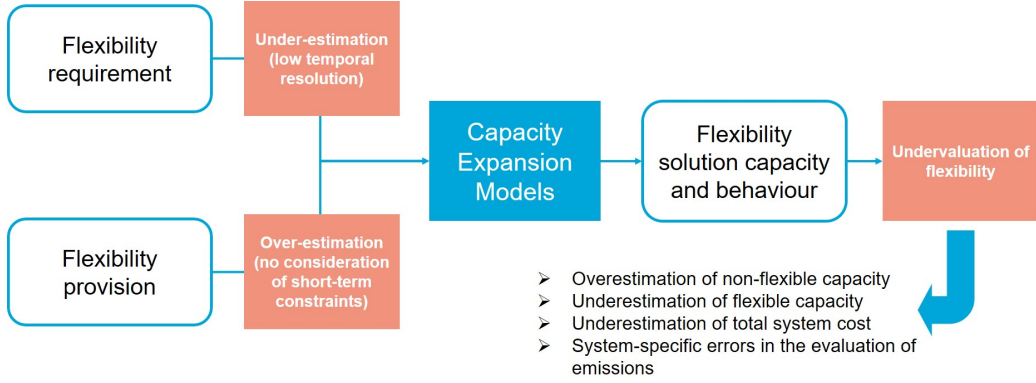

Figure 1: Simplifications made in Capacity Expansion Models cause flexibility to be undervalued. This leads to errors in optimal installed capacities, total system cost and emissions.

Flexibility requirement is generally understood to be dictated by both predictable and unpredictable variations in net load. This variability has been shown to increase with VRE shares [11, 12], particularly on the daily, weekly and annual timescales, with increasing share of solar, wind and hydro generation respectively. This multi-timescale increase in flexibility requirement is particularly hard to express in CExMs, due to their use of time-series reduction techniques, necessary to ensure computational tractability [13, 14, 15, 16, 17]. This time-series reduction can be achieved using timeslices or representative days/weeks, with many possible implementation methods (*e.g.* simple averaging, down-sampling, clustering, duration curve-based...). Much research has been carried out to improve the details of these techniques [17, 18, 19, 20, 21, 15]. Comparisons suggest that simple averaging performs the worst, but that no sophisticated approach consistently out-performs the others. They do however lead to substantial differences in investment strategies [22, 23], and the appropriate choice in time-series reduction technique has also been found to be system-specific [24]. Whatever the technique used, issues are likely to occur in terms of the expression of chronology, of inter-variable correlations, as well as geographical aspects of flexibility in multi-regional studies (particularly if regions have different shares of wind or solar).

Flexibility provision consists in having dispatchable technologies adjust their behaviour to match variations in net load. Increasing VRE shares

transform the structure of the generation mix and hence the way flexibility is provided [25]. Generation, storage, network interconnection or flexible load all have many technical and economic parameters that limit their ability to provide flexibility (*e.g.* minimum power output, up/down ramping capability, start-up and shut-down times, minimum up and down times, energy capacity, recovery periods). These parameters, typically considered in unit-commitment and economic dispatch problems³, cannot be expressed faithfully in CExMs due to the lack of chronology between stylised model time steps and/or low temporal resolution, hence leading to an over-estimation of technologies' ability to provide flexibility [13, 28, 29, 30].

As a result of these simplifications, CExMs fail to express the full complexity of the flexibility challenge, leading to biases on model outputs that happen to be key for policy makers. These biases have been the focus of a large body of research, and are now well understood. Total system costs tend to be underestimated [3, 13, 31, 32, 33, 34], with system-specific CO₂ emission evaluation errors. The optimal capacity of technologies that worsen the flexibility challenge or that are of limited help (VRE, baseload generation) tends to be overestimated, while the optimal capacity of technologies that mitigate the flexibility challenge are underestimated (mid-merit generation, storage, interconnection, flexible demand) [17, 33, 35, 36]. In studies that simulate the detailed operation of systems proposed by CExMs, this leads to unacceptably high levels of loss-of-load [32, 34, 36, 37], raising doubts as to the relevance of such development plans for policy recommendation purposes.

Many of the aforementioned studies have tried to refine these observations, improving the collective understanding of when such simplifications are the most problematic. While the discussed impacts unsurprisingly worsen with VRE penetration [13, 38, 22, 24], they also depend on system characteristics [24, 30, 32, 39]: if ample flexibility is already available (*e.g.* hydro), poor representation is less of an issue. Testing constraints individually rather than collectively, Palmintier *et al.* [29] showed that operating reserves and maintenance are the most important and hour-to-hour ramping the least. Interestingly, Poncelet *et al.* [13] have also shown that the impact of poor temporal resolution is more significant than that of poor operational detail (*i.e.* consideration of technical constraints).

Much work has also been carried out to adapt modelling approaches to

³Which are formulated in models such as Antares [26] or PLEXOS [27].

solve the issues mentioned here, as is discussed in the following review papers [40, 41, 42]. However, this is beyond the scope of this paper and will hence not be discussed here.

1.2. *Reviewing the impact of maximum investment rates*

While they can be a point of interest in best practices papers [2] and papers with a strong review element [43, 44], maximum investment rates have comparatively received far less attention from model or case study focussed papers⁴. Investment constraints such as technology growth rates or market shares are typically used as calibration techniques to ensure models propose credible investment pathways. The way their associated parameter values are set is rarely discussed or even mentioned, making it difficult to judge the relevance of the case study setup and hence the validity of model outputs.

There are a few notable exceptions, first and foremost Heuberger *et al.* [45]. Introducing an endogenous learning-by-doing feature in the ESO model, they found that maximum investment rates had a greater impact on total system costs than learning-by-doing, shedding light on the interaction between the two. Other recent studies using the ESO model family also make sure to discuss maximum investment rates settings [47, 48]. In the latter, investment constraints are a centre piece in the case study narrative.

Outside the ESO model community, a few scarce papers briefly mention this concept in the case study setup [49], or propose a few sensitivity analyses to increase the robustness of obtained results [36, 46]. Note that outside academia, in industrial settings, annual limits to the investment in different technologies can be a core parameter in power system planning studies [50].

1.3. *Key contributions and paper structure*

As discussed extensively in the literature review, there has been plenty of recent work on the impact of poor representation of flexibility on CExM outcomes, much less so on the impact of maximum investment rates. To the best of our knowledge, despite a few sensitivity analyses proposed by Mallapragada *et al.* [36], the impact on CExM outcomes of these two core model features has never been systematically compared. This comparison is the main contribution of this paper, examining how past observations made

⁴Note that this concept may be referred by a variety of other terms, such as “build rates” [45], “implementation speed constraints” [43], or “generation growth caps” [46]

on the impact of temporal resolution hold up when investment rate limits are taken into account. The results of this comparison will help model users take the appropriate care during case study setups, but also provide guidance to the target audiences of planning studies, helping them judge the relevance of the key assumptions that are made, whether explicit or implicit.

The methodology used for this study is described in Section 2, covering the modelling framework (including a novel power transmission module), the case study set-up and the sensitivity analysis protocol used to evaluate the relative impact of maximum investment rate versus flexibility requirement representation. Section 3 provides the results of this analysis, focussing on several model outcomes: total system costs, annual energy mix and flexibility solution capacity. Section 4 briefly discusses the various implications of these results.

2. Methodology

The proposed methodology is based on the open-source modelling framework OSeMOSYS (see Subsection 2.1), to which a novel interconnection module was added to improve the representation of power flows and allow investment in new capacity (see Appendix A). This framework is used to model the development of the European power system between 2015 and 2050, represented using 17 different regions (see Subsection 2.2). Model runs are performed based on 9 different timeslice structures, ranging from 24 to 336 timeslices, designed to have different qualities of inter-daily and intra-daily variability representation. Simulations are run for 4 different brownfield scenarios, with different levels of investment rate and CO₂ budget constraints (see Subsection 2.3).

2.1. OSeMOSYS overview

OSeMOSYS is an open-source modelling framework designed for long-term energy system planning. It can be used to gain insights into the future developments of a specific system by proposing optimal investment pathways based on a total system cost minimisation, using a central planner perspective. A system is represented using a succession of technologies and fuels, the former being able to both use and produce the latter. The OSeMOSYS problem was first described in a journal paper in 2011 by Howells *et al.* [51] and has undergone significant development since then (see [52] for an overview of the progress made up to 2018, or [53] for the up-to-date online user manual).

There have been many applications of OSeMOSYS to build models of specific energy systems, such as OSeMBE’s model of Europe [49], TEMBA’s model of Africa [54], SAMBA’s model of South America [55], or GENeSYS-MOD’s world model [56]. In the first three applications, the authors used OSeMOSYS’ basic representation of power flows between regions. Investment in trade capacity is not endogenous; instead, different capacities are tested for sensitivity analysis purposes, through the use of additional constraints. This representation of the cross-border interconnection was considered too rough to model the European system, as it is a major flexibility provider on this system [25] and its capacity has increased in recent years and is expected to increase further in the future [57, 58]. In GENeSYS-MOD, a consistent power transmission module was added, allowing endogenous grid expansion. There are a few limitations with the proposed module, most notably (i) the absence of interconnector operational life or salvage value, distorting the competition between flexibility solutions, and (ii) the use of a maximum interconnector capacity growth rate expressed as a percentage, disallowing investment on a border with no existing capacity. To solve these limitations and unify the module nomenclature with that of OSeMOSYS, an adaptation is proposed, described in detail in Appendix A.

Note that the OSeMOSYS code is available in several programming languages, and that it can be used to build either linear or mixed-integer linear problems depending on whether “lumpy” investment is to be considered, which can then be solved using many different solvers. In this study, the Pyomo [59] version of the code was used. Investment was considered to be linear as the modelled regions were assumed to be sufficiently big, and the formulated problem was solved using XPRESS [60].

2.2. Case study description

OSeMOSYS was used to optimise investment pathways for the European power system from 2015 to 2050, in 5-year investment time steps. The geographical scope and granularity are shown in Figure 2. Within each region, a number of technologies and fuels are considered; their nature and relations can be seen in Figure 3. Initial system capacities are provided. Note that these are not only present for the beginning of the investment period, but also for a certain number of years, according to their operational life. The model scope is limited to the power system, the links with other energy vectors are expressed through power plants alone. It is anticipated that not considering

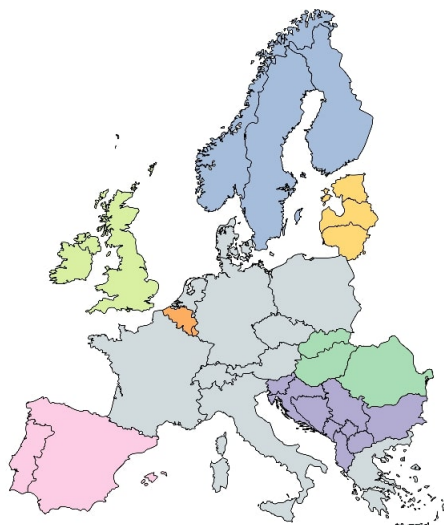

Figure 2: Geographical scope and granularity of the modelled European power system. Grey countries are modelled as their own region, while other countries are aggregated according to the colour code (*e.g.* Spain and Portugal are grouped in an “Iberian peninsula” region).

H₂ and CH₄ technologies (electrolysis, methanation, fuel cells and hydrogen fuelled gas turbines) could potentially downplay this paper’s conclusions regarding the relative impacts of maximum investment rates vs flexibility requirement representation: considering them would likely increase electricity consumption and hence exacerbate the impact of maximum investment rates.

OSeMOSYS parameter values (*e.g.* annual demand, investment costs, renewable potentials, emission limits, CO₂ costs...) were provided by the H2020 European project OSMOSE. The full dataset is publicly available online, including the load and VRE time-series used to generate timeslice values [61].

2.3. Sensitivity analysis protocol

To evaluate the relative impacts of flexibility requirement representation and maximum investment rates on model outcomes, many different model runs were performed using different sets of input data. How these data sets were built will now be discussed.

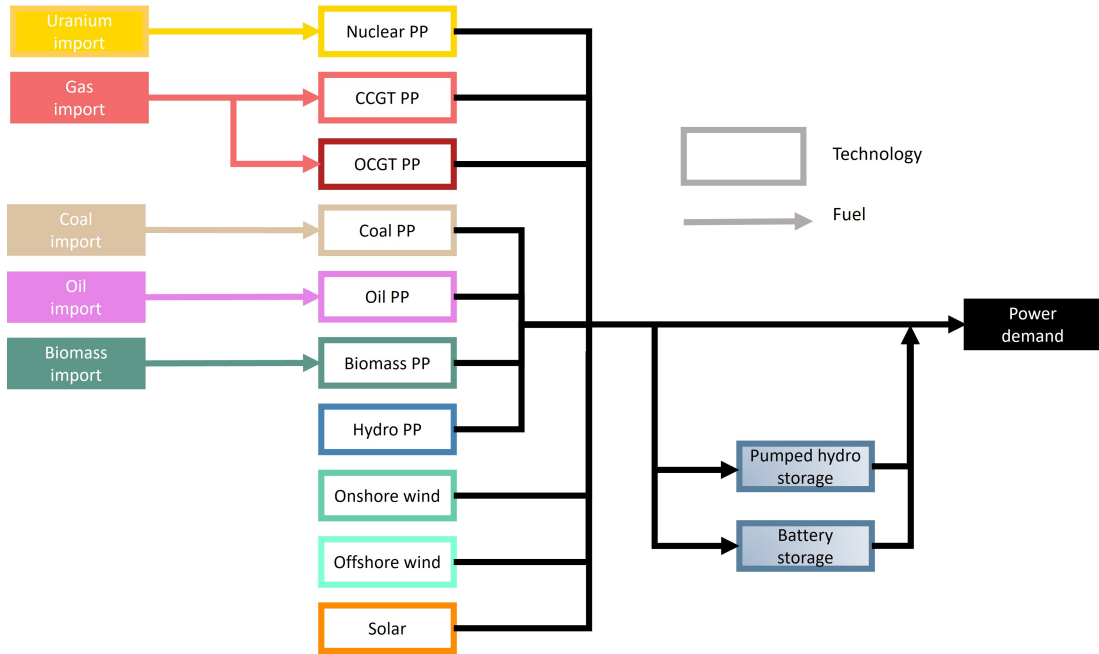

Figure 3: Description of the technologies and fuels considered in the European system model. PP stands for power plant.

2.3.1. Flexibility requirement representation

Ideally, in power system planning, one would like to express the variability of load and VRE generation through hourly time-series over several years. However, the typical size of the problem to be solved by CExMs does not allow this, particularly when a large number of nodes and/or technologies are considered. To reduce problem size, load and VRE time variability is expressed in condensed form. Different CExMs may perform time-series reduction in different ways; OSeMOSYS uses timeslices. Each investment year is composed of a set of seasons, which are each composed of a set of day-types, themselves composed of a set of dailytimebrackets. The user can specify their number, size and order, but they must be defined uniformly over investment years and regions.

To ensure net load variability is appropriately expressed despite the use of timeslices, special care must be taken. As shown in Figure 4, solar generation curves frequency spectra have three vastly dominating frequency components: annual, daily and half daily. As a result, expressing solar variability

using timeslices can be reasonably well achieved through seasons and daily-time-brackets. Wind generation curves, on the other hand, have much more irregular frequency spectra. They tend to have a significant annual component, a daily component in certain geographical locations, and many sporadic low frequency components which are different year on year. As a result, expressing wind variability using timeslices is less straightforward than it is for solar, and requires the consideration of a great many days.

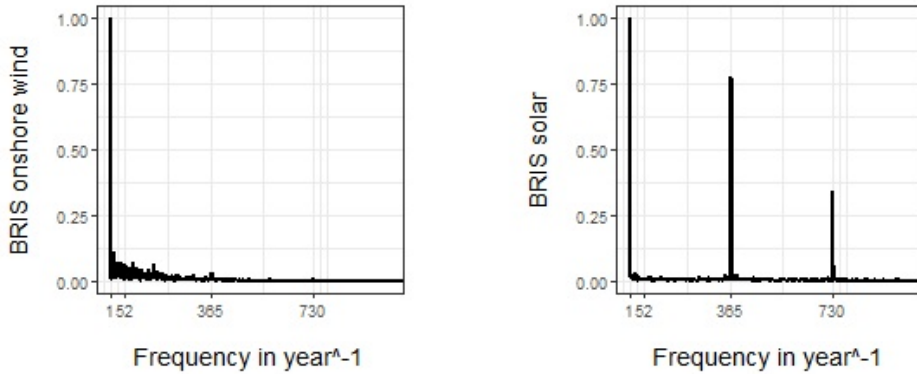

Figure 4: Normalised power spectral densities of onshore wind (left) and solar (right) hourly time-series for the British Isles, based on one of the 35 years of data.

To evaluate the impact of the quality of flexibility requirement representation, model runs were performed using different timeslice implementations. As described in Table 1, they have different numbers of days per season and hourly resolutions, allowing the consideration of different degrees of inter-daily and intra-daily variability expression respectively. All timeslices within a season were fitted in a single day-type.

Table 1: Different implementations of timeslice structures.

| Number of timeslices | Number of seasons | Number of days per season | Hourly granularity |
|----------------------|-------------------|---------------------------|--------------------|
| 24 | 4 | 1 | 4 |
| 48 | 4 | 2 | 4 |
| 72 | 4 | 3 | 4 |
| 96 | 4 | 3 | 3 |
| 128 | 4 | 4 | 3 |
| 168 | 4 | 7 | 4 |
| 224 | 4 | 7 | 3 |
| 288 | 4 | 9 | 3 |
| 336 | 4 | 14 | 4 |

Days were individually sampled at random. This, of course, is not recommended practice for a traditional capacity expansion study. Here, however, the logic of the sensitivity analysis is to obtain an upper bound of the impact of temporal detail on model outcomes, relative to the impact of maximum investment rates. Had days been chosen using a “smarter” algorithm, the relative impact of temporal detail would hence be expected to be lower. To evaluate the impact of this random sampling of days, for each timeslice structure shown in table 1, a set of 6 runs was performed, each with different random days.

To fully appreciate the impact of temporal detail on CExM outcomes, one would ideally want to consider structures with yet more timeslices, perhaps as many as 8760 to provide a benchmark. However, despite solving the formulated problem on a high-performance server, a 17-node system representation leads to a problem size which does not allow this: in the 336-timeslice structure, it reached around 60 million constraints and variables, needing several days and 300 gigabytes of random-access-memory to run (note that only the “long” version of the OSeMOSYS code is available under Pyomo, this was hence the version that was used [53]). However, the focus of this study is the relative impacts of maximum investment rates and temporal detail. As such, the study should concentrate on problem sizes that are likely to be managed by model users (note that for a system with fewer regions, more timeslices could be managed). Moreover, as will be discussed in section 3, this analysis suggests that capacity expansion model outcomes are more sensitive to the choice of representative days than to the number of timeslices.

2.3.2. Investment scenarios

Each of these timeslice structures were applied to 4 different scenarios, with different investment constraint set-ups. As expressed in Table 2, scenarios vary in terms of maximum investment rates and CO₂ budgets.

CO₂ budgets are defined per region and per investment time step, and follow a decreasing curve to reach the 2050 value given in Table 2 for the whole of Europe. In the first three scenarios, the associated constraint usually becomes binding quite early in the investment period. Note that only the CO₂ emitted during a technology’s operation is considered, the CO₂ emitted during construction is not.

Table 2: Description of the 4 investment scenarios.

| Scenario name | European 2050 CO ₂ budget | Maximum investment rate |
|-----------------------------------|--------------------------------------|-----------------------------|
| <i>Base case</i> | 106 MT / year | 32.4 GW / year / technology |
| <i>High investment rate</i> | 106 MT / year | 64.8 GW / year / technology |
| <i>Unlimited investment rate</i> | 106 MT / year | Unlimited |
| <i>High CO₂ budget</i> | 1060 MT / year | Unlimited |

Defining investment rate limits is not a straightforward question [44]. Historic data is typically used for conventional generation, but for emerging technologies, comparing recent development in neighbouring countries is one of the few options available [45, 48]. In this study, scenarios with contrasted values were defined.

The maximum investment rate in the *base case* scenario was determined by observing maximum development rates over 5-year periods during two historical settings with intense generation commissioning: the French nuclear fleet in the 1970s and 1980s and renewables in Germany in the 2010s. A value of 25 GW per 5-year investment step per technology was thus set for Germany, applied uniformly over all technologies. This value of 25 GW was then ratio-ed down for each region, according to its annual electricity demand. Over the full European system, this sums up to 162 GW per investment step, or 32.4 GW per year, for each technology.

This value should not be treated as an accurate figure, but rather as an ambitious assumption considering past ability of the power industry to roll-out new infrastructure at speed. The sensitivity analysis protocol thus provides a lower bound to the impact of maximum investment rates on model outcomes. There is recent evidence to suggest that with strong political backing, the investment rate of specific technologies can be improved. Note that improving these rates would likely be easier for modular technologies such as solar, and harder for more complex and centralised technologies such as nuclear. The French nuclear roll-out in the 1970s and 1980s has indeed been pointed out to be quite an extraordinary feat [62].

3. Results

The relative impacts of maximum investment rates and temporal detail on OSeMOSYS outcomes are compared for several output variables: total system costs, generation and flexibility solution installed capacity, along with annual generation mix.

3.1. Impact on total system costs

Figure 5 clearly shows that, unsurprisingly, constraining the investment problem leads to optimal investment pathways with higher total system costs. This increase is substantial: for the same CO₂ budget, around 18% between the *unlimited investment rate* and *base case* scenarios, a gap that tends to widen as more timeslices are considered. As maximum investment rate decreases, cheaper generation technologies reach their investment rate limit, and more expensive solutions must be built instead.

The effect of increasing the number of timeslices on total system costs is comparatively not as clear and much more limited. Regression attempts provide both positive and negative slopes depending on the scenario, very poor R² values and statistically insignificant p-values.

The impact of the random sampling of days decreases slightly as the number of timeslices increases, but still remains significant. This implies that even for a high number of timeslices, the way representative periods are chosen remains important.

3.2. Impact on installed generation, interconnection and storage capacity

Just like total system costs, 2050 European installed capacities are much more impacted by maximum investment rates than by temporal detail.

In the two scenarios where the investment rate is not limited, the 2050 European power system has around 2100 GW of solar power (the differences between these two scenarios are quite limited: a larger CO₂ budget allows some wind and nuclear capacity to be replaced by gas plants). However, reaching such levels of solar capacity requires construction rates far beyond what can be expected if energy policy does not change, the *base case* investment rate already being ambitious. As a result, solar capacity is replaced initially mostly by onshore wind power (*high investment rate* scenario), then by nuclear and offshore wind power (*base case* scenario).

Note that this switching between generation technologies translates to different levels of total capacity due to differences in capacity factors. Also, this switching would likely have been different had a different carbon budget been imposed.

The partial switch from solar to wind and nuclear leads to a lower need for flexibility. As a result, installed capacities for gas units, batteries and interconnectors drop from 255 GW to 130 GW, 500 GW to 135 GW, and 450 GW to 220 GW respectively between the *unlimited investment rate* and *base case* scenarios (averaged over all timeslice structures).

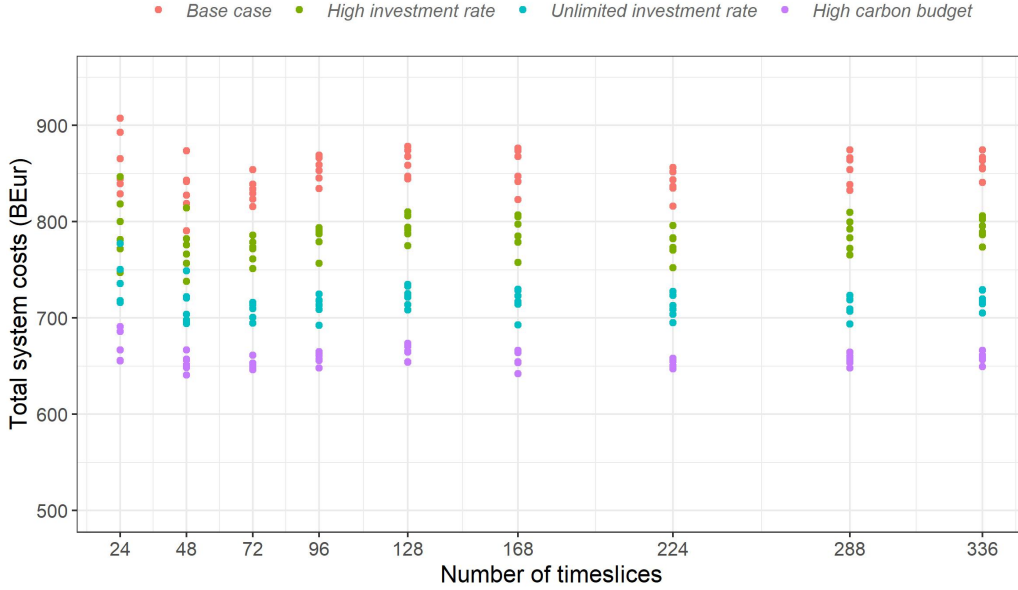

Figure 5: Total system costs for different timeslice structures and investment scenarios. Each point corresponds to an OSeMOSYS optimisation, and the equations provide the parameters of linear regressions of the impact of timeslice number on total system cost. As described in Section 2.3.1, timeslice structures were tested with 6 different sets of random days.

In comparison, as illustrated by the fairly low R^2 values reported in Table 3, the effect of the number of timeslices on installed capacity is quite limited, rather unclear, with slight variations between each scenario. In the *unlimited investment rate* scenario for example, improving the representation of flexibility requirement leads to a drop in the value of wind generation, which is very partially replaced by solar capacity. Interconnectors being more suited to flexibility provision in wind-dominated systems and batteries to solar-dominated ones, the capacity of the former is reduced while that of the latter is increased. In the *base case* scenario, investment rates disallow such an option, and the effect of improving temporal detail is yet more limited and chaotic, preventing any serious interpretation. The reasons for this rather limited effect of the number of timeslices will be made clearer in the coming section.

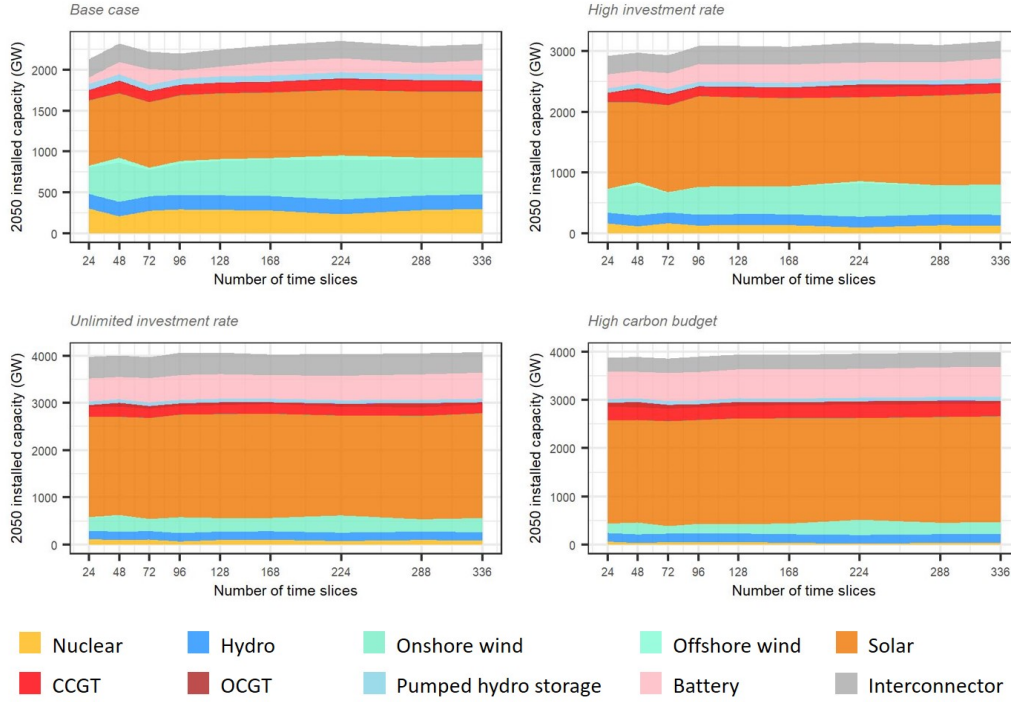

Figure 6: Impact of timeslice number on the 2050 European installed capacities, for each of the four investment scenarios. For each timeslice structure, plotted values correspond to the average of the results of the 6 runs with different random days. Note that the scales on the y-axes of the 4 sub-plots are different.

Table 3: Linear regression coefficients for 2050 European installed capacities in terms of timeslice number, for the *base case* and *unlimited investment rate* scenarios.

| Technology | <i>Base Case</i> | | | <i>Unlimited investment rate</i> | | |
|----------------|-------------------------|----------------|----------|----------------------------------|----------------|----------|
| | Linear regression model | R ² | p-value | Linear regression model | R ² | p-value |
| Nuclear | 260 + 0.043 x | 0.32 | 8.7e-04 | 96 - 0.035 x | 0.11 | 2.2e-09 |
| Onshore wind | 380 + 0.28 x | 0.42 | <2.2e-16 | 310 - 0.02 x | 0.0049 | 0.21 |
| Offshore wind | 39 - 0.046 x | 0.1 | 6.5e-09 | 7.5 - 0.031 x | 0.35 | <2.2e-16 |
| Solar | 790 + 0.032 x | 0.52 | <2.2e-16 | 2100 + 0.19 x | 0.23 | <2.2e-16 |
| CCGT | 130 - 0.018 x | 0.2 | <2.2e-16 | 200 - 0.072 x | 0.41 | <2.2e-16 |
| OCGT | 4.9 + 0.021 x | 0.29 | <2.2e-16 | 52 - 0.041 x | 0.082 | 1.5e-07 |
| Battery | 130 + 0.092 x | 0.13 | 7e-11 | 490 + 0.17 x | 0.63 | <2.2e-16 |
| Interconnector | 220 - 0.056 x | 0.58 | <2.2e-16 | 460 - 0.054 x | 0.35 | <2.2e-16 |

3.3. Impact on annual generation mix

The observations made previously on the relative impacts of maximum investment rates and temporal detail also apply to annual generation mixes, with starker overall impact due to capacity factor differences in technologies involved in the discussed switches (see Figure 7).

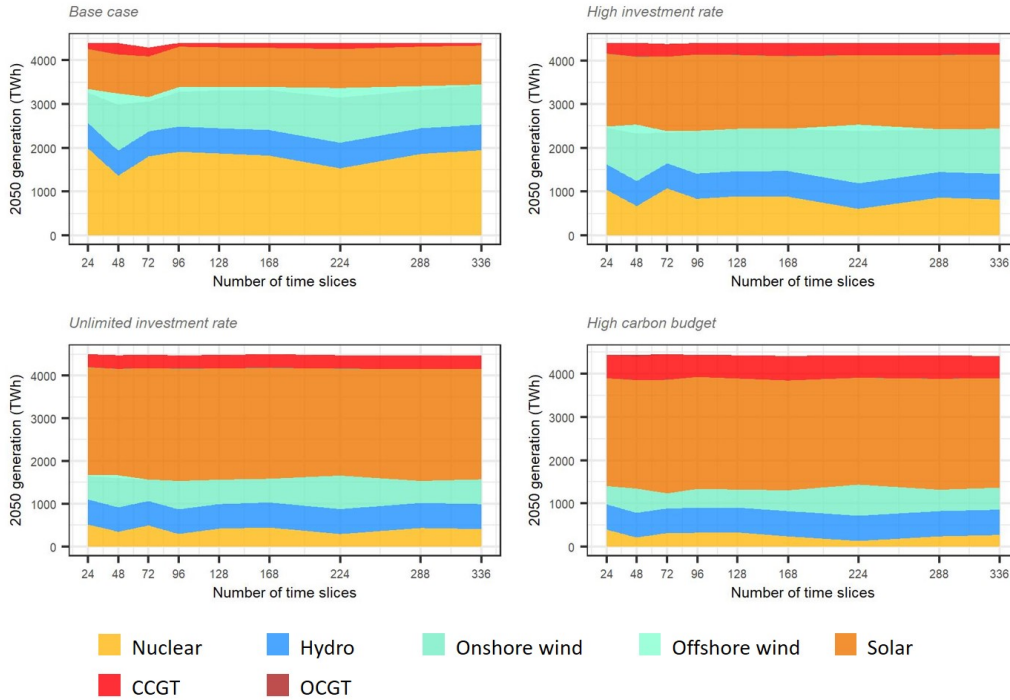

Figure 7: Impact of timeslice number on the 2050 European annual generation, for each of the four investment scenarios. For each timeslice structure, plotted values correspond to the average of the results of the 6 runs with different random days. Annual generation may differ very slightly depending on the optimal solution’s investment and use of storage infrastructure.

In the two scenarios unaffected by investment rate considerations, the 2050 European generation mix is composed, averaging over all timeslice runs, of 58% solar, 13% wind and 8% nuclear power, gas generation playing a different but limited role depending on the CO₂ budget. In the *high investment rate* scenario, this balance already moves to 38%, 23% and 19% respectively. In the *base case* scenario which, compared to historical data, has the most

realistic yet ambitious construction rates, the 2050 European generation mix is composed of around 21% solar, 22% wind and 41% nuclear power.

Averages over timeslice structures hide some variability over the different timeslice runs, however. While the combination of Figures 8 and 9 once again confirm the dominating effect of the investment scenario, they also show that within a scenario, the differences in the European 2050 generation mix are almost entirely dictated by the random sampling of days, not the number of timeslices. Indeed, increasing the number of timeslices has little effect both on the mean and the distribution width of the generation technology annual output.

This is likely the key reason this analysis fails to clearly reproduce all of the effects recorded in the literature and discussed in Section ?? (increased temporal detail leads to a reduction in non-flexible capacity, an increase in flexible capacity, and an increase in total system costs). The experimental approach, designed to provide an upper bound to the impact of temporal detail relative to maximum investment rates, introduces random noise through its sampling of days, making these effects inaudible. In contrast, these effects can be picked up by existing studies which build model time steps using smarter methods, hence removing the random effect of day sampling.

There is another interesting point to make regarding the differences in behaviours between wind and solar power. Within a scenario, solar generation is relatively stable, confirming what was mentioned in Section 2.3.1: solar variability is reasonably well expressed by a limited number of timeslices (at least at this geographical granularity). In contrast, optimal wind power generation varies a lot between simulations, along with nuclear which ends up compensating these variations. The effect of the random sampling of days remains significant even when 7 days per season are used, highlighting the value of using “smarter” algorithms to select representative days to improve wind variability representation.

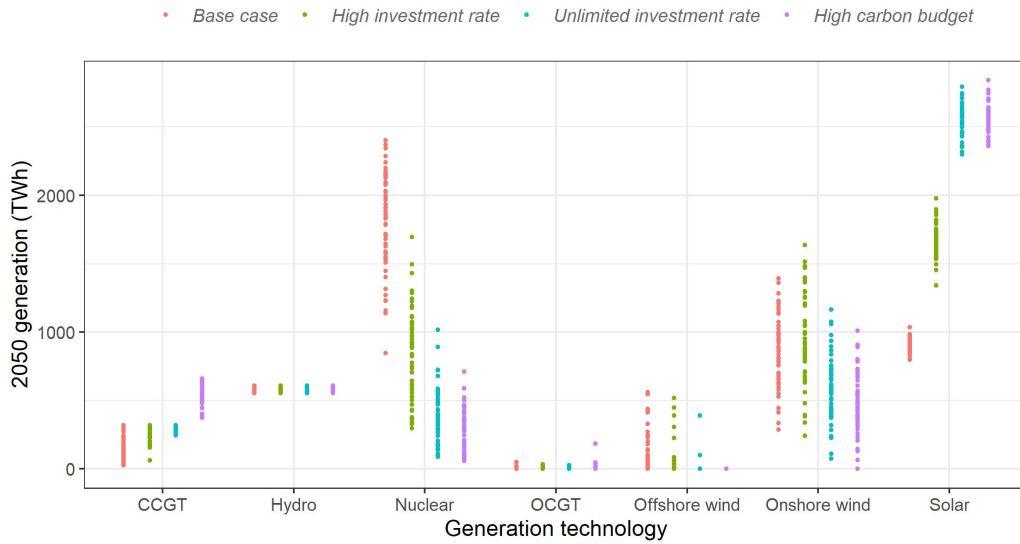

Figure 8: Impact of investment scenario and random sampling of days on 2050 European annual generation. Each point corresponds to a single simulation, for a particular random sampling of days. Within a colour group, the results for simulation with different numbers of timeslices are hence represented.

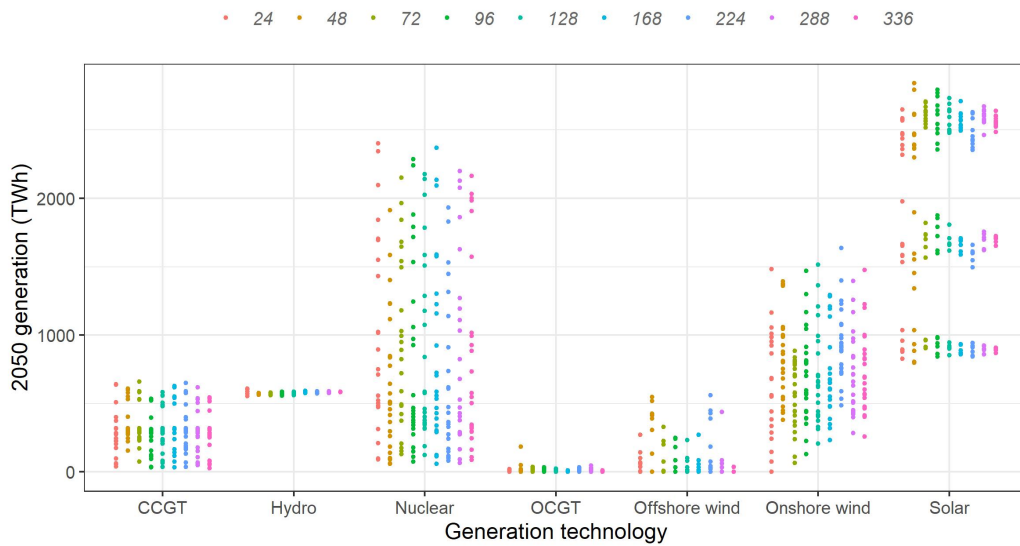

Figure 9: Impact of timeslice structure and random sampling of days on 2050 European annual generation. Each point corresponds to a single simulation, for a particular random sampling of days. Within a colour group, the results for simulation in different investment scenarios are hence represented.

4. Conclusions

Applying the capacity expansion model OSeMOSYS (with an added novel power transmission module) to a European power system case-study, this paper described a thorough sensitivity analysis exploring the relative impacts of maximum investment rates and temporal detail on key model outputs: total system costs, the capacity of generation, interconnection and storage, along with annual generation mix. The proposed sensitivity analysis protocol provides (i) an upper bound to the impact of temporal detail, as temporal detail was varied both in terms of number of time steps and through a random sampling of days, and (ii) a lower bound to the impact of maximum investment rates, set at ambitious levels compared to historical data. Despite these, the impact of maximum investment rates was shown to be greater than temporal detail on all of the examined model outputs. Note that there may be some system-specificity in these conclusions: while they apply for large, continental-scale studies, they may be less relevant for a model of an industrial complex or of a small island system.

Beyond modelling contributions through the power transmission module, there are several important implications to the results of this work. First of all, in terms of the design of capacity expansion models, more time steps is not necessarily better. If full time-series cannot be used due to computational issues, choosing representative periods carefully is essential to ensure appropriate expression of wind power variability.

Next in terms of the use of capacity expansion models, one should be mindful of technology construction rates. Their effect on key model outputs is far too significant to neglect a thorough and transparent discussion on how related parameters are set, and on the extent to which they impact the study's key messages. Of course, these precautions apply to both the person performing the study and the one reading the resulting report or paper.

Finally in terms of policy recommendations, the results of this work stress how much hopes of meeting climate targets hinge on the ability of the power sector to roll-out new low-carbon infrastructure fast enough. Provided the current mindset vis-à-vis energy demand perpetuates, the main issue facing power system planners should perhaps less be what low-carbon technology or combination of technologies to build, and more the acceleration of the construction of all currently available low-carbon technologies.

There are many interrelated potential bottlenecks that may impact this ability to accelerate: public and private actors financial capacity, institu-

tional development approval times, manufacturing plants’ output capacity, civil engineering companies’ available manpower, transmission and distribution network connection times etc. Some of these could become all the more problematic were the post-Covid logistical issues around raw-material and parts to persist in years to come. Fortunately, most of these limiting factors could also be alleviated by sound energy policy, and some recent developments are promising. Providing actors with long-term visibility and stability is paramount to allow them to invest in new manufacturing capacity, as well as recruit and train a larger workforce. This also reduces investment risk and hence cost of capital and total system costs.

An important final point to make on the relative impacts of maximum investment rates and temporal detail: this analysis concerns capacity expansion models only. There are many issues related to temporal detail that such models are structurally unable to grasp, which may yet have a significant impact on power system planning. More detailed studies using other model families are necessary to make sure solutions proposed by capacity expansion models are able to ensure adequacy, stability and inertia, or that they are compatible with internal network constraints.

5. Acknowledgements

This work is part of the OSMOSE project, which provided the data used in the this research. It has received funding from the European Union’s Horizon 2020 research and innovation program under grant agreement n°773406. This article reflects only the authors’ views. The European Commission is not responsible for any use that may be made of the information it contains. The European Commission was not involved in study design, data analysis or writing of this paper.

Appendix A. Power transmission module

The OSeMOSYS-compatible power transmission module proposed here builds upon the module initially proposed by Löffler *et al.* for GENeSYS-MOD (see their GitLab for the full problem formulation [63]). Note that both the original and the improved versions of the module are based on an enforcement of Kirchoff’s current law, but not Kirchoff’s voltage law.

There are several problems with the original module. (i) An interconnector has neither operational life nor salvage value. This distorts competition

between flexibility solutions by discouraging investment in transmission capacity when compared to generation or storage. (ii) The use of a percentage to limit the growth rate of interconnector capacity means it is not possible to build new capacity on a border that does not already have some (as well as requiring the addition of specific equations to deal with the limits of the investment period). (iii) The modelling doesn't allow asymmetric interconnector capacity, a common feature in power system data sets, which reflect internal network constraints (*e.g.* ENTSO-E datasets [58]). Besides these functional issues, there are also a few problems with style: the nomenclature of parameters and variables doesn't match that of the rest of OSeMOSYS, making the use of the transmission module very prone to error.

This new power transmission module solves these issues and was directly integrated to the OSeMOSYS problem described in the official user manual [53]. It was designed and tested with the modelling of the power system in mind, but by setting the appropriate parameter values, its structure can be used to represent the transport of other network-based energy vectors. The parameters, variables and constraints that were added to the OSeMOSYS formulation are listed below, along with the existing OSeMOSYS constraints that were modified.

Nomenclature

| | |
|---------|---------------------------------------|
| f | Fuel |
| l | Timeslice list |
| r, rr | Region |
| s | Storage device |
| t | Technology |
| y | Year composing the investment pathway |

Appendix A.1. Additional parameters

Table A.4: Parameters added to the OSeMOSYS formulation

| Name | Defined on | Description |
|-------------------------------|-------------|--|
| TradeRoute | r, rr, f, y | Binary indicator linking regions to one another. |
| TradeLossBetweenRegions | r, rr, f, y | Fraction of the energy lost when traded between a pair of regions. |
| ResidualTradeCapacity | r, rr, f, y | Remaining trade capacity available from before the modelling period. |
| CapitalCostTrade | r, rr, f | Capital investment cost of increasing a link's capacity, per unit of capacity. |
| TotalAnnualMaxTradeInvestment | r, rr, f, y | Maximum annual capacity investment in a link. |
| OperationalLifeTrade | r, rr, f, y | Useful life of an interconnector. |

Appendix A.2. Additional variables

Table A.5: Variables added to the OSeMOSYS formulation

| Name | Defined on | Unit | Description |
|----------------------------------|------------------|----------|--|
| Import | r, rr, f, y, l | Energy | Quantity of fuel imported by region r from region rr in timeslice l (≥ 0). |
| Export | r, rr, f, y, l | Energy | Quantity of fuel exported by region r to region rr in timeslice l (≥ 0). |
| NewTradeCapacity | r, rr, f, y | Power | Newly installed trade capacity between regions r and rr in year y (≥ 0). |
| TotalTradeCapacityAnnual | r, rr, f, y | Power | Total trade capacity installed in year y (≥ 0). |
| AccumulatedNewTradeCapacity | r, rr, f, y | Power | Cumulative newly installed trade capacity from the beginning of the time domain to year y . |
| CapitalInvestmentTrade | r, rr, f, y | Monetary | Undiscounted investment in new trade capacity between regions r and rr (≥ 0). |
| DiscountedCapitalInvestmentTrade | r, rr, f, y | Monetary | Investment in new trade capacity discounted through <code>DiscountRate</code> (≥ 0). |
| SalvageValueTrade | r, rr, f, y | Monetary | Salvage value of an interconnector in year y , as a function of parameters <code>OperationalLifeTrade</code> and <code>DepreciationMethod</code> (≥ 0). |
| DiscountedSalvageValueTrade | r, rr, f, y | Monetary | Salvage value of an interconnector discounted through the parameter <code>DiscountRate</code> (≥ 0). |
| TotalDiscountedTradeCost | r, rr, f, y | Monetary | Difference between the discounted capital investment in new interconnection capacity and the salvage value in year y (≥ 0). |
| NetTrade | r, f, y, l | Energy | For region r and timeslice l , the sum of imports and exports to and from neighbouring regions. |
| NetTradeAnnual | r, f, y | Energy | For region r , annual sum of imports and exports to and from neighbouring regions. |

Appendix A.3. Modifications made to OSeMOSYS constraints

Note that the equation names are those used in the official OSeMOSYS formulation [53]. Parameters are written in bold, variables in italics.

$$s.t. \quad \forall_{r,rr,f,y,l} \quad \mathit{Export}_{r,rr,f,y,l} = \mathit{Import}_{rr,r,f,y,l} \quad (\text{EBa10})$$

$$s.t. \quad \forall_{r,f,y,l} \quad \mathit{Production}_{r,f,y,l} \geq \mathit{Demand}_{r,f,y,l} + \mathit{Use}_{r,f,y,l} + \mathit{NetTrade}_{r,f,y,l} \quad (\text{EBa11})$$

$$s.t. \quad \forall_{r,f,y} \quad \textit{NetTradeAnnual}_{r,f,y} = \sum_l \textit{NetTrade}_{r,f,y,l} \quad (\text{EBb3})$$

$$s.t. \quad \forall_{r,f,y} \quad \textit{ProductionAnnual}_{r,f,y} \geq \textit{UseAnnual}_{r,f,y} + \textbf{AccumulatedAnnualDemand}_{r,f,y} + \textit{NetTradeAnnual}_{r,f,y} \quad (\text{EBb4})$$

$$s.t. \quad \forall_{r,y} \quad \textit{TotalDiscountedCost}_{r,y} = \sum_t \textit{TotalDiscountedCostByTechnology}_{r,t,y} + \sum_s \textit{TotalDiscountedStorageCost}_{r,s,y} + \sum_f \sum_{rr} \textit{TotalDiscountedTradeCost}_{r,rr,f,y} \quad (\text{TDC2})$$

Appendix A.4. Additional constraints

Equation EBA12 is added to the block of Energy Balance equations, while the others form a new block of Transmission Constraints. Note that this new block of constraints apply only to the fuel named “Power”. Parameters are written in bold, variables in italics.

$$s.t. \quad \forall_{r,f,y,l} \quad \textit{NetTrade}_{r,f,y,l} = \sum_{rr} (\textit{Export}_{r,rr,f,y,l} * (1 + \textbf{TradeLossBetweenRegions}_{r,rr,f,y}) - \textit{Import}_{r,rr,f,y,l}) \quad (\text{EBA12})$$

$$s.t. \quad \forall_{r,rr,f=\textit{Power},y,l} \quad \textit{TotalTradeCapacityAnnual}_{r,rr,f,y} * (1 + \textbf{TradeLossBetweenRegions}_{r,rr,f,y}) \geq \frac{\textit{Export}_{r,rr,f,y,l}}{\textbf{CapacityToActivityUnit}_{r,t} * \textit{YearSplit}_{y,l}} \quad (\text{TC1a})$$

$$s.t. \quad \forall_{r,rr,f=\textit{Power},y,l} \quad \textit{TotalTradeCapacityAnnual}_{r,rr,f,y} * (1 + \textbf{TradeLossBetweenRegions}_{r,rr,f,y}) \geq \frac{\textit{Import}_{r,rr,f,y,l}}{\textbf{CapacityToActivityUnit}_{r,t} * \textit{YearSplit}_{y,l}} \quad (\text{TC1b})$$

$$s.t. \quad \forall_{r,rr,f=\textit{Power},y} \quad \textit{TotalTradeCapacityAnnual}_{r,rr,f,y} = \textit{AccumulatedNewTradeCapacity}_{r,rr,f,y} + \textbf{ResidualTradeCapacity}_{r,rr,f,y} \quad (\text{TC2})$$

References

- [1] IEA, NREL, Status of power system transformation, Technical Report, International Energy Agency, 2018.
- [2] J. DeCarolis, H. Daly, P. Dodds, I. Keppo, F. Li, W. McDowall, S. Pye, N. Strachan, E. Trutnevyte, W. Usher, others, Formalizing best practice for energy system optimization modelling, *Applied energy* 194 (2017) 184–198. Publisher: Elsevier.
- [3] M. Welsch, P. Deane, M. Howells, B. O. Gallachoir, F. Rogan, M. Bazilian, H.-H. Rogner, Incorporating flexibility requirements into long-term energy system models—A case study on high levels of renewable electricity penetration in Ireland, *Applied Energy* 135 (2014) 600–615.
- [4] H.-K. Ringkjøb, P. M. Haugan, I. M. Solbrekke, A review of modelling tools for energy and electricity systems with large shares of variable renewables, *Renewable and Sustainable Energy Reviews* 96 (2018) 440–459.
- [5] D. Connolly, H. Lund, B. V. Mathiesen, M. Leahy, A review of computer tools for analysing the integration of renewable energy into various energy systems, *Applied Energy* 87 (2010) 1059–1082.
- [6] V. Oree, S. Z. S. Hassen, P. J. Fleming, Generation expansion planning optimisation with renewable energy integration: A review, *Renewable and Sustainable Energy Reviews* 69 (2017) 790–803.
- [7] IEA, Overview of TIMES modelling tool, 2020. URL: <https://iea-etsap.org/index.php/etsap-tools/model-generators/times>.
- [8] IIASA, MESSAGE, 2013. URL: <https://iiasa.ac.at/web/home/research/modelsData/MESSAGE/MESSAGE.en.html>.
- [9] E. lab, The PRIMES model, 2020. URL: http://www.e3mlab.eu/e3mlab/index.php?option=com_content&view=category&id=35%3Aprimess&Itemid=80&layout=default&lang=en.
- [10] O. community, OSeMOSYS, 2022. URL: <http://www.osemosys.org/>.

- [11] T. Heggarty, J.-Y. Bourmaud, R. Girard, G. Kariniotakis, Multi-temporal assessment of power system flexibility requirement, *Applied Energy* 238 (2019) 1327–1336.
- [12] M. Huber, D. Dimkova, T. Hamacher, Integration of wind and solar power in Europe: Assessment of flexibility requirements, *Energy* 69 (2014) 236–246.
- [13] K. Poncelet, E. Delarue, D. Six, J. Duerinck, W. D’haeseleer, Impact of the level of temporal and operational detail in energy-system planning models, *Applied Energy* 162 (2016) 631–643.
- [14] S. Ludig, M. Haller, E. Schmid, N. Bauer, Fluctuating renewables in a long-term climate change mitigation strategy, *Energy* 36 (2011) 6674–6685.
- [15] M. Hoffmann, L. Kotzur, D. Stolten, The Pareto-optimal temporal aggregation of energy system models, *Applied Energy* 315 (2022) 119029. Publisher: Elsevier.
- [16] A. Pina, C. Silva, P. Ferrão, Modeling hourly electricity dynamics for policy making in long-term scenarios, *Energy Policy* 39 (2011) 4692–4702.
- [17] J. H. Merrick, On representation of temporal variability in electricity capacity planning models, *Energy Economics* 59 (2016) 261–274.
- [18] P. Nahmmacher, E. Schmid, L. Hirth, B. Knopf, Carpe diem: A novel approach to select representative days for long-term power system modeling, *Energy* 112 (2016) 430–442.
- [19] L. Kotzur, P. Markewitz, M. Robinius, D. Stolten, Time series aggregation for energy system design: Modeling seasonal storage, *Applied Energy* 213 (2018) 123–135. Publisher: Elsevier.
- [20] K. Poncelet, H. Höschle, E. Delarue, A. Virag, W. D’haeseleer, Selecting representative days for capturing the implications of integrating intermittent renewables in generation expansion planning problems, *IEEE Transactions on Power Systems* 32 (2016) 1936–1948. Publisher: IEEE.

- [21] M. Hoffmann, L. Kotzur, D. Stolten, M. Robinius, A review on time series aggregation methods for energy system models, *Energies* 13 (2020) 641. Publisher: Multidisciplinary Digital Publishing Institute.
- [22] S. Pfenninger, Dealing with multiple decades of hourly wind and PV time series in energy models: A comparison of methods to reduce time resolution and the planning implications of inter-annual variability, *Applied energy* 197 (2017) 1–13. Publisher: Elsevier.
- [23] L. Göke, M. Kendzioriski, Adequacy of time-series reduction for renewable energy systems, *Energy* 238 (2022) 121701. Publisher: Elsevier.
- [24] L. Kotzur, P. Markewitz, M. Robinius, D. Stolten, Impact of different time series aggregation methods on optimal energy system design, *Renewable energy* 117 (2018) 474–487. Publisher: Elsevier.
- [25] T. Heggarty, J.-Y. Bourmaud, R. Girard, G. Kariniotakis, Quantifying power system flexibility provision, *Applied Energy* 279 (2020) 115852. Publisher: Elsevier.
- [26] RTE, Antares simulator, 2022. URL: <https://antares-simulator.org/>.
- [27] E. Exemplar, PLEXOS, 2022. URL: <https://energyexemplar.com/solutions/plexos/>.
- [28] S. Quoilin, W. Nijs, I. H. Gonzalez, A. Zucker, C. Thiel, Evaluation of simplified flexibility evaluation tools using a unit commitment model, in: 2015 12th International Conference on the European Energy Market (EEM), IEEE, 2015, pp. 1–5.
- [29] B. Palmintier, Flexibility in generation planning: Identifying key operating constraints, in: 2014 power systems computation conference, IEEE, 2014, pp. 1–7.
- [30] A. Shortt, J. Kiviluoma, M. O’Malley, Accommodating variability in generation planning, *IEEE Transactions on Power Systems* 28 (2012) 158–169. Publisher: IEEE.
- [31] J. Deane, A. Chiodi, M. Gargiulo, B. O Gallachoir, Soft-linking of a power systems model to an energy systems model, *Energy* 42 (2012) 303–312.

- [32] B. S. Palmintier, M. D. Webster, Impact of operational flexibility on electricity generation planning with renewable and carbon targets, *IEEE Transactions on Sustainable Energy* 7 (2015) 672–684. Publisher: IEEE.
- [33] F. Ueckerdt, R. Brecha, G. Luderer, P. Sullivan, E. Schmid, N. Bauer, D. Böttger, R. Pietzcker, Representing power sector variability and the integration of variable renewables in long-term energy-economy models using residual load duration curves, *Energy* 90 (2015) 1799–1814.
- [34] T. Heggarty, Techno-economic optimisation of the mix of power system flexibility solutions, PhD Thesis, Université Paris sciences et lettres, 2021. URL: <https://pastel.archives-ouvertes.fr/tel-03461279/document>.
- [35] A. Pina, C. A. Silva, P. Ferrão, High-resolution modeling framework for planning electricity systems with high penetration of renewables, *Applied Energy* 112 (2013) 215–223.
- [36] D. S. Mallapragada, D. J. Papageorgiou, A. Venkatesh, C. L. Lara, I. E. Grossmann, Impact of model resolution on scenario outcomes for electricity sector system expansion, *Energy* 163 (2018) 1231–1244. Publisher: Elsevier.
- [37] Y. Alimou, N. Maïzi, J.-Y. Bourmaud, M. Li, Assessing the security of electricity supply through multi-scale modeling: The TIMES-ANTARES linking approach, *Applied Energy* 279 (2020) 115717. Publisher: Elsevier.
- [38] M. Nicolosi, The importance of high temporal resolution in modeling renewable energy penetration scenarios, Lawrence Berkeley National Laboratory (2010).
- [39] K. Poncelet, E. Delarue, W. D’haeseleer, Unit commitment constraints in long-term planning models: Relevance, pitfalls and the role of assumptions on flexibility, *Applied Energy* 258 (2020) 113843. Publisher: Elsevier.
- [40] N. Heliö, J. Kiviluoma, H. Holttinen, J. D. Lara, B.-M. Hodge, Including operational aspects in the planning of power systems with large

- amounts of variable generation: A review of modeling approaches, *Wiley Interdisciplinary Reviews: Energy and Environment* 8 (2019) e341. Publisher: Wiley Online Library.
- [41] S. Collins, J. P. Deane, K. Poncelet, E. Panos, R. C. Pietzcker, E. Delarue, B. P. O Gallachoir, Integrating short term variations of the power system into integrated energy system models: A methodological review, *Renewable and Sustainable Energy Reviews* 76 (2017) 839–856.
- [42] IRENA, Planning for the renewable future - Long term modelling and tools to expand variable renewable power in emerging economies, Technical Report, International Renewable Energy Agency, 2017.
- [43] J. A. Ouassou, J. Straus, M. Fodstad, G. Reigstad, O. Wolfgang, Applying endogenous learning models in energy system optimization, *Energies* 14 (2021) 4819. Publisher: MDPI.
- [44] Z. Tao, J. A. Moncada, K. Poncelet, E. Delarue, Review and analysis of investment decision making algorithms in long-term agent-based electric power system simulation models, *Renewable and Sustainable Energy Reviews* 136 (2021) 110405. Publisher: Elsevier.
- [45] C. F. Heuberger, E. S. Rubin, I. Staffell, N. Shah, N. Mac Dowell, Power capacity expansion planning considering endogenous technology cost learning, *Applied Energy* 204 (2017) 831–845. Publisher: Elsevier.
- [46] A. L. F. Acevedo, A. Jahanbani-Ardakani, H. Nosair, A. Venkatraman, J. D. McCalley, A. Bloom, D. Osborn, J. Caspary, J. Okullo, J. Bakke, others, Design and valuation of high-capacity HVDC macrogrid transmission for the continental US, *IEEE Transactions on Power Systems* 36 (2020) 2750–2760. Publisher: IEEE.
- [47] C. F. Heuberger, P. K. Bains, N. Mac Dowell, The EV-olution of the power system: A spatio-temporal optimisation model to investigate the impact of electric vehicle deployment, *Applied Energy* 257 (2020) 113715. Publisher: Elsevier.
- [48] C. Ganzer, Y. W. Pratama, N. Mac Dowell, The role and value of inter-seasonal grid-scale energy storage in net zero electricity systems, *International Journal of Greenhouse Gas Control* 120 (2022) 103740. Publisher: Elsevier.

- [49] H. T. Henke, F. Gardumi, M. Howells, The open source electricity Model Base for Europe-An engagement framework for open and transparent European energy modelling, *Energy* 239 (2022) 121973. Publisher: Elsevier.
- [50] RTE, Energy pathways to 2050 - Key results, Technical Report, Réseau de Transport d'Electricité, 2021. URL: https://assets.rte-france.com/prod/public/2022-01/Energy%20pathways%202050_Key%20results.pdf.
- [51] M. Howells, H. Rogner, N. Strachan, C. Heaps, H. Huntington, S. Kypreos, A. Hughes, S. Silveira, J. DeCarolis, M. Bazillian, others, OSeMOSYS: the open source energy modeling system: an introduction to its ethos, structure and development, *Energy Policy* 39 (2011) 5850–5870.
- [52] F. Gardumi, A. Shivakumar, R. Morrison, C. Taliotis, O. Broad, A. Beltramo, V. Sridharan, M. Howells, J. Hörsch, T. Niet, others, From the development of an open-source energy modelling tool to its application and the creation of communities of practice: The example of OSeMOSYS, *Energy strategy reviews* 20 (2018) 209–228. Publisher: Elsevier.
- [53] M. Howells, OSeMOSYS user manual, 2022. URL: <https://osemosys.readthedocs.io/en/latest/manual/Structure%20of%20OSeMOSYS.html>.
- [54] C. Taliotis, A. Shivakumar, E. Ramos, M. Howells, D. Mentis, V. Sridharan, O. Broad, L. Mofor, An indicative analysis of investment opportunities in the African electricity supply sector—Using TEMBA (The Electricity Model Base for Africa), *Energy for Sustainable Development* 31 (2016) 50–66. Publisher: Elsevier.
- [55] G. N. P. de Moura, L. F. L. Legey, M. Howells, A Brazilian perspective of power systems integration using OSeMOSYS SAMBA—South America Model Base—and the bargaining power of neighbouring countries: A cooperative games approach, *Energy Policy* 115 (2018) 470–485. Publisher: Elsevier.

- [56] K. Löffler, K. Hainsch, T. Burandt, P.-Y. Oei, C. Kemfert, C. Von Hirschhausen, Designing a model for the global energy system—GENeSYS-MOD: an application of the Open-Source Energy Modeling System (OSeMOSYS), *Energies* 10 (2017) 1468.
- [57] ENTSO-E, Mid-term adequacy forecast - Appendix 2, Technical Report, ENTSO-E, 2019. URL: <https://eepublicdownloads.blob.core.windows.net/public-cdn-container/clean-documents/sdc-documents/MAF/2019/MAF%202019%20Appendix%20%20-%20Methodology.pdf>.
- [58] ENTSO-E, Ten Year Network Development Plan 2018 - Appendix, Technical Report, ENTSO-E, 2018. URL: <https://eepublicdownloads.blob.core.windows.net/public-cdn-container/clean-documents/tyndp-documents/TYNDP2018/consultation/Main%20Report/TYNDP18%20Exec%20Report%20appendix.pdf>.
- [59] S. N. Laboratories, Pyomo, 2022. URL: <https://pyomo.readthedocs.io/en/stable/>.
- [60] FICO, FICO Xpress Solver, 2021. URL: <https://www.fico.com/en/products/fico-xpress-solver>.
- [61] J.-Y. Bourmaud, L. Göke, N. Grisey, M. Kostic, N. Lhuillier, D. Orlic, J. Weibezahn, T. Heggarty, Osmose wp1 dataset, 2022. URL: <https://doi.org/10.5281/zenodo.7323821>. doi:10.5281/zenodo.7323821.
- [62] A. Grubler, The costs of the French nuclear scale-up: A case of negative learning by doing, *Energy Policy* 38 (2010) 5174–5188.
- [63] K. Löffler, GENeSYS-MOD GitLab, 2022. URL: <https://git.tu-berlin.de/genesysmod/genesys-mod-public>.