



HAL
open science

Single or double patch clamp recordings in the ex vivo slice preparation: functional connectivity, synapse dynamics and optogenetics

Jean Simonnet, Louis Richevaux, Desdemona Fricker

► To cite this version:

Jean Simonnet, Louis Richevaux, Desdemona Fricker. Single or double patch clamp recordings in the ex vivo slice preparation: functional connectivity, synapse dynamics and optogenetics. Patch Clamp Electrophysiology: Methods and Protocols,, 2021, Methods in Molecular Biology,, 10.1007/978-1-0716-0818-0_15 . hal-04368714

HAL Id: hal-04368714

<https://hal.science/hal-04368714v1>

Submitted on 1 Jan 2024

HAL is a multi-disciplinary open access archive for the deposit and dissemination of scientific research documents, whether they are published or not. The documents may come from teaching and research institutions in France or abroad, or from public or private research centers.

L'archive ouverte pluridisciplinaire **HAL**, est destinée au dépôt et à la diffusion de documents scientifiques de niveau recherche, publiés ou non, émanant des établissements d'enseignement et de recherche français ou étrangers, des laboratoires publics ou privés.



Distributed under a Creative Commons Attribution 4.0 International License

1 **TITLE:**

2

3 **Single or double patch clamp recordings in the ex vivo slice preparation:**
4 **functional connectivity, synapse dynamics and optogenetics.**

5

6 **AUTHORS & AFFILIATIONS:**

7 Jean Simonnet¹, Louis Richevaux^{2,3}, and Desdemona Fricker^{2,3}

8 *1 Bernstein Center for Computational Neuroscience Berlin, Humboldt-Universität zu Berlin,*
9 *Berlin, Germany*

10 *2 CNRS (Integrative Neuroscience and Cognition Center, UMR 8002), Paris, France*

11 *3 Université Paris Descartes, Sorbonne Paris Cité, Paris, France*

12

13 *Corresponding Author: Desdemona Fricker*

14 *Email Address: desdemona.fricker@parisdescartes.fr*

15 *Tel: (+33)-1-4286-4370*

16

17 **KEYWORDS:**

18 whole-cell patch-clamp recording, electrophysiology, excitability, inhibition, channelrhodopsin,
19 optogenetics, acute brain slice, hippocampus, synaptic transmission.

20

21

22

23 **ABSTRACT**

24 Patch clamp recordings are the method of choice to define cell-type specific
25 electrophysiological properties of single neurons and the synaptic connectivity between pairs of
26 connected neurons in brain slices. In combination with optogenetic tools, patch clamp
27 recordings allow the investigation of long-range afferent connectivity from identified distant
28 brain areas. Here we describe the necessary equipment to carry out patch clamp recordings,
29 surgical methods for dissection and preparation of horizontal brain slices containing the
30 hippocampus, and a step-by-step guide for establishing patch clamp recordings in the whole
31 cell configuration. We provide protocols for single neuron stimulation via the patch pipette and
32 for photostimulation experiments that activate axon terminals expressing light sensitive ion
33 channels.

34

35 **1. Introduction**

36

37 Action potential firing in central nervous system neuronal circuits underlies specific functions,
38 including the integration of sensory information, the regulation of autonomous processes,
39 driving cognition or specific behaviors. Understanding how neural circuit activity is encoded
40 requires knowledge of anatomy, single neuron and synaptic physiology, as well as local and
41 brain wide functional connectivity.

42

43 The patch clamp technique [1][2][3] is the gold standard for investigating ion channel behavior,
44 single neuron physiology and synaptic function. It has led to major discoveries in neuroscience.
45 Patch clamping has been used to tackle a broad range of questions, from the characterization of
46 intrinsic membrane currents [4][5][6], the firing properties of neurons [7] and synaptic
47 properties [8] *ex vivo*, to the study of subthreshold membrane potential fluctuations and action
48 potential firing in freely behaving animals [9]. It is therefore a powerful tool to study the
49 neurophysiology at different levels of integration, from the molecular level to the animal's
50 behavior.

51

52 We have used patch clamp recordings in acute slices from wild-type or transgenic mice, to
53 study neuronal intrinsic properties [10][11], cellular anatomy [12][13], synaptic connectivity
54 and dynamics as well as integration of long-range synaptic inputs [14][15]. The present
55 methods article focuses on the equipment and the procedures that we routinely use in our
56 laboratory.

57

58 Specifically, we describe how to dissect the mouse brain for *ex vivo* slice recording, the
59 preparation of hippocampal slices and how to carry out patch clamp recordings, including a
60 schematic of our setup dedicated to patch clamp and optogenetics experiments. We describe
61 how to prepare solutions used to immerse the brain tissue during slicing and during recordings,
62 as well as the internal solutions used to fill the patch pipettes. We provide details about
63 preparing the animal, the brain dissection, our slicing method and slice handling procedures
64 and we describe, step-by-step, how to perform single or dual patch clamp recordings. We
65 advise on key methods and protocols for recording neuronal intrinsic properties, testing the
66 connectivity between pairs of neurons, investigating synaptic dynamics and studying the
67 integration of long-range inputs using optogenetics tools.

68

69

70 **2. Materials**

71

72 **2.1. External solutions**

73 Prepare two types of external solutions, a “cutting solution” and artificial cerebrospinal fluid
74 (“ASCF”) for recording, from using ultrapure water (resistance 18MΩ) from the lab’s water
75 purification systems (Table 1; see **Note 1**).

76

77

[Table 1 here]

78

79 To improve reproducibility and save time, prepare 10X stock solutions without the divalent
80 cations, CaCl₂ and MgCl₂, which should be prepared separately as 1 M solutions. Keep stock
81 solutions at 4°C. The final solutions (1X) must be prepared the day of the experiment.

82

83 These external solutions must be bubbled constantly with oxygen/carbon dioxide (O₂/CO₂,
84 95/5%).

85

86 **2.2. Internal solutions**

87 The internal solution is used to fill the patch pipette and will be in direct contact with the cell’s
88 interior. It is one of the most important factors determining the success of a patching
89 experiment. Preparing the internal solution requires concentration and controls. Take the
90 necessary time.

91

92 *2.2.1. Water quality.* Use ultrapure water. We use cell culture graded distilled water (Gibco, ref.
93 15230089, Thermo Fisher).

94

95 *2.2.2. Stability.* As internal solutions contain temperature sensitive compounds, prepare them
96 on ice. Aliquots can be stored in the freezer (-20°C) up to one year.

97

98 *2.2.3. Examples of internal solutions.* Here we describe the composition of two types of
99 solutions that we have used. Choose the internal depending on your scientific question and the
100 type of recording that is appropriate (Table 2; see **Note 2**).

101

102

[Table 2 here]

103

104 - Low-chloride potassium gluconate-based (Low-Cl K-gluc) internal solution, contains (in
105 mM): 145 K-gluconate, 2 KCl, 10 HEPES, 0–0.2 ethylene glycol tetra-acetic acid (EGTA), 2
106 MgCl₂, 4 Mg-ATP, 0.4 Tris-GTP, 10 Na₂-phosphocreatine.

107

108 - Cesium gluconate-based (Cs-gluc) internal solution, contains (in mM): 135 Cs-gluconate
109 (from solutions CsOH and D-gluconic acid), 5 KCl, 10 HEPES, 0–0.2 EGTA, 2 MgCl₂, 4
110 MgATP, 0.4 Tris-GTP, 10 Na₂-phosphocreatine.

111

112 *2.2.4. Cellular anatomy: biocytin in the internal solution*

113 For post-hoc recovery of the cellular anatomy, biocytin (1 – 3 mg/ml, Tocris 3349 or Sigma
114 B4261-50MG) – or alternatively Neurobiotin (Vector laboratories SP-1120) – is added to the
115 internal solution.

116

117 **2.3. Preparing solutions**

118 1. Add the compounds one by one in ultrapure water (80% of the final volume in a beaker
119 or an equivalent piece of glassware), following the order indicated above. Add the
120 biocytin at the end and stir for 10 - 20 min.

121 2. Adjust the pH (in our hands it is too low initially) to 7.2 – 7.4 using the appropriate
122 solution (Cs-OH for Cs-based solution or K-OH for K-based solution). This will also help to
123 obtain complete dissolution of all compounds.

124 3. Transfer the solution to a container allowing precise measure of the volume (a buret
125 would be good) and adjust to the final volume with ultrapure water.

126 4. Control of Osmolality (Wescor Vapor Pressure Osmometer VAPRO, calibrate prior to
127 measures). If high (most of the time), calculate the dilution factor to reach 290-300
128 MOsm and add the appropriate volume of ultrapure water. For instance, if the initial
129 measure is 330 MOsm, for a total of 23 ml of internal solution, add 2.3 ml H₂O. If too
130 low, add the main compound (Cs Gluc or K Gluc). Adjust, stir for a minute, and then
131 check the osmolality again. Repeat the procedure until an osmolality of 290-300 MOsm
132 is reached.

133 5. Make Aliquots (750 µl or 1ml) and store at -20°C to allow a convenient use of 1 aliquot
134 per day of experiment.

135

136 **2.3. Pharmacology.**

137 Prepare aliquots of the pharmacological compounds and to store them at -20°C. When possible,
138 we recommend stock concentrations of 1000x for easy calculation of final dilution the day of
139 the experiment (e. g. final concentration obtained by diluting 20 µl in 20 ml; Table 3).

140

141 [Table 3 here]

142

143 **2.4. Dissection and slicing**

144

145 [Figure 1: Dissection and slicing equipment]

146

147 *Dissection*

148 1. Versi-dry bench absorbant paper (Fig. 1A; Nalgene 62065-00 Versi-Dry Paper Lab Soaker
149 Roll)

150 2. 0.3 to 1 ml syringes (Terumo MYJECTOR 29G ref. BS30M2913; Terumo 27G ref.
151 FE12705)

152 3. 25G needles (Terumo NN-2516R)

153 4. Curved forceps (FST 11011-17)

154 5. Big scissors (Dahle Allround 50038)

155 6. Small scissors (FST 14060-09)

156 7. Curved hemostat (FST 13005-14)

- 157 8. Butterfly needle (Venofix A, 24G 0.55 x 20 mm L:30 cm; Braun 4056361)
158 9. 60 ml syringe (Terumo 112268)
159 10. Tubing with a roller clamp (Baxter C0334)

160

161 *Slicing*

- 162 1. Vibratome (Fig. 1B; Leica VT1200S)
163 2. Double edge stainless steel razor blades (Electron Microscopy Sciences, Cat. #72000)
164 3. Filter paper (Whatman 1001 090)
165 4. Superglue (Loctite Superglue 3)
166 5. Slice transfer pipette (shortened glass Pasteur pipette equipped with a pear)

167

168 *Slice storage chamber*

- 169 1. made from a nylon stocking stretched and superglued over a round support, held at
170 mid-level in a beaker, later filled with ACSF and gently bubble with O₂/CO₂ 95/5%. A 3-D
171 printer can be used for support shapes with individual wells (Fig. 1C).
172 2. Bain-marie (Julabo TW8)

173

174 **2.5. Patch clamp setup**

- 175 1. The patch clamp set-up needs to be installed on an antivibration air-table inside a
176 faraday cage (Fig. 2).
177 2. We use a BX51WI Microscope from Olympus, equipped with a 5x and a 60x objective, an
178 infrared filter and DIC imaging.
179 3. A Multiclamp amplifier with a pair of CV-7B headstages from Axon Instruments is
180 interfaced via a Digidata 1440A Digitizer with a PC, running pClamp software for data
181 acquisition.

182

183 [Figure 2 - EPHYs SETUP HERE]

184

185

- 186 4. Whole field blue and/or red illumination can be obtained via a twin OptoLED light
187 source coupled into the microscope via a triple port (Cairn, UK). Appropriate filters for
188 blue and/or red illumination are indicated in Fig. 3. The third port accommodates a laser
189 for 1P focal illumination (Omicron LuxX laser: 405nm, 300mW; Fig. 3).
190 5. Optical stimulation is commanded via an isolated pulse stimulator (A-M systems Model
191 2100), and triggered by the acquisition software.
192 6. A Luca EMCCD camera from Andor serves to visualize brain slices during patching.
193 7. Electrode holders for 1.5 mm glass are from G23 Instruments (ISO-S-1.5G
194 microelectrode holders, Greenwich, London, UK). Inelastic polyethylene tubing to apply
195 positive or negative pressure to the pipette is attached at the holder. Use
196 electrophoresis of HCl solution to apply chloride to the silver wire that plunges in the
197 internal solution in the patch pipette [16].
198 8. We use a pump for perfusion of the recording chamber (Gilson Minipuls 3 Peristaltic
199 pump) to allow recycling of ASCF. This may be very useful if the ASCF contains expensive
200 drugs. Otherwise gravity-driven perfusion works well, too, combined with a suction at

- 201 the outlet of the chamber. ACSF warmed up to 35-37°C and bubbled with 5% CO₂ in O₂.
202 ACSF perfusion speed, 2-3 ml/min in submerged chamber.
- 203 9. The faraday cage and all electrically powered instruments need to be connected to a
204 common ground reference on the table.
 - 205 10. Harp to hold the slices down. Harps can be purchased from Warner instruments (metal
206 slice anchor) or custom fabricated in the lab. Bend a platinum wire (Advent, Oxford,
207 PT542104) to give it a U-shaped form, hammer it a bit to reduce the height, then glue 4-
208 8 thin nylon threads (from nylon stocking) on the two parallel bars of the U in a striped
209 motif (Fig. 4).
 - 210 11. Recording software (in our case, pClamp, Molecular Devices) allowing continuous or
211 episodic stimulation and recording.

212
213 [Figure 3 – microscope + filters for illumination]
214

215 **2.6. Patch clamp pipettes**

- 216 1. Borosilicate glass capillaries of external diameter 1.5 mm, thick walled with filament for
217 easy filling (Fig. 4; Harvard Apparatus, GC150F-10).
- 218 2. Brown–Flaming Micropipette horizontal puller (P97 Sutter Instruments) with a 2.5x2.5
219 box filament (S-FB255B).
- 220 3. Follow the instructions written in the "pipette cookbook", available for download from
221 sutter.com.
- 222 4. Custom pipette filling system: 1 ml syringe with a 0.2 µm syringe filter (Nalgene, ref.
223 171-0020); a shortened 200 µl pipette tip is used as an adaptor piece for the
224 Microloader (20 µl, Eppendorf, ref. 5242 956.003; Fig. 4)

225
226 [Figure 4 - accessories]
227

228 **3. Methods**

229 230 **3.1. Getting started for slicing**

- 231 1. On the day of the electrophysiological recording experiment, prepare the cutting
232 solution and ACSF (1X) by diluting the 10X stock solutions with ultrapure water, not
233 adjusting to the final volume yet, and bubble the solutions with 95/5% O₂/CO₂. Add
234 MgCl₂ and CaCl₂ (after a few minutes of oxygenation, avoiding precipitation) then adjust
235 to the final volume with ultrapure water.
- 236 2. Keep the cutting solution on ice (2 – 4°C) and gently bubble with 95/5% O₂/CO₂.
- 237 3. Keep ASCF at room temperature and gently bubble with 95/5% O₂/CO₂.
- 238 4. Prepare the perfusion and dissection station as well as the slice storage chamber (Fig.
239 1). Work in clean conditions. Sterilization is not required but use alcohol for cleaning
240 the surgical instruments, and also for the holding chamber. Clean and/or change the
241 tubing regularly.

244
245
246
247
248
249
250
251
252
253
254
255
256
257
258
259
260
261
262
263
264
265
266
267
268
269
270
271
272
273
274
275
276
277
278
279
280
281
282
283
284
285
286
287

3.2. Anesthesia

The animal must be deeply anesthetized (see **Note 3**). Inject a mixture of ketamine-xylazine (100/15 mg/kg respectively, diluted in 0.9% NaCl) intraperitoneally. Then begin the dissection and slicing procedure (Fig. 5).

3.3. Perfusion

1. Place the perfusion syringe 80 cm above the bench and fill it with ice-cold oxygenated cutting solution. Let the solution run through the attached tubing until it flows out of the butterfly needle. Check that there are no air bubbles in the tubing and stop the flow using the roller clamp.
2. Once the animal is deeply anesthetized, use adhesive tape to maintain the animal stretched out on its back on the bench surgery area. Palpate the sternum, incise the skin immediately above it, and elevate it to expose the abdominal muscles. Incise these muscles to expose the diaphragm and the liver immediately below it on the right side of the abdomen. The sternum is elevated using tweezers. Incise the diaphragm following the ventral lower edge of the rib cage. Care must be taken not to puncture the liver or the heart. Cut open the entire rib cage on both sides from caudal to rostral, using scissors, as dorsal as possible. Use a clamp to hold the sternum bent upwards, over the animal's head, exposing the heart.
3. Inject 500 units (100 μ l) of heparin (Heparin Choay 5 000 U.I./ml) slowly into the left ventricle.
4. Clamp the descending aorta just above the liver. Release the flow of cutting solution and set the perfusion speed to 1 - 2 ml per minute. Insert the butterfly needle in the left ventricle and cut open the right atrium with small scissors within 1 to 2 seconds. When 30-40 ml of cutting solution have been perfused, the liquid coming out from the atrium should be translucent and the lungs have turned white.
5. Decapitate the animal and place the head in cold cutting solution in a Petri dish.

3.4. Brain dissection for hippocampal slices

1. Incise the scalp following the midline, from the caudal end to between the eyes, using small scissors. Pull down the skin to either side to expose the skull. Remove vertebrae that may have remained attached to the skull, as well as the conjunctive tissue on the skull and the muscles on the side, to expose Lambda. Using the very tip of small scissors, the skull is opened caudally and extending rostrally, towards the orbits.
2. Make a T-shaped incision by adding a small perpendicular cut just caudal to the orbit, on both sides. Make a horizontal cut of the occipital bones from the foramen magnum to the external auditory meatus.
3. Hold the head horizontally, between index and thumb, and pull one side of the cranial bone sideways away from the brain. The movement resembles the turning of the page of a book. Repeat for the other half of the skull. The head should then be held by the

288 sideways bent half skulls on either side of the brain. The ventral part of the skull cavity
289 should be gently separated from the brain by inserting a round spatula under the brain.
290 Thus the brain is separated from the cranial nerves with the spatula. Extract the brain,
291 and immerse it in clean cold oxygenated cutting solution. Depending of the brain
292 structure of interest the brain may be further dissected to obtain the final block to slice.

- 293 4. Identify which side of the block should be glued. For horizontal hippocampal slices, glue
294 the cortex to the vibratome's cutting plate, so that the brain sits upside down for slicing.
295 Gently position the cortex side of the brain on filter paper, to remove liquid.
- 296 5. Spread a thin and homogeneous layer of superglue on the vibratome's cutting plate and
297 transfer the block on top of it. Then submerge the plate with the brain in cutting
298 solution.
- 299 6. Cut the brain in 200-400 μm -thick slices (see **Note 4**) at a speed of 0.05-0.07 mm/s and
300 an amplitude of 0.9-1 mm. Additional scalpel cuts may reduce the size of the slices and
301 facilitate their handling and positioning in the resting and recording chambers.

302

303 **3.5. Slice recovery**

304 Using the slice transfer pipette, place the slices in the recovery chamber filled with ACSF in a
305 35°C warm water bath. Let the slices recover for 15 min, then take the chamber out of the
306 warm bath and let it rest at room temperature for about 45 min before use.

307

308 **3.6. Pipette pulling and internal solution**

309 Pull pipettes to obtain a resistance of 3-8 M Ω once filled with internal solution. You may wish to
310 check the tip shape under the microscope (see **Note 5**). Keep pipettes in a box until use. Handle
311 carefully, do not touch the tip, protect from dust). Prepare the custom pipette filling system
312 with the internal solution. Aspirate the internal solution in the syringe and position,
313 sequentially, the filter, the 200 μl pipette tip and the microloader (Fig. 4). Chase any bubbles.
314 Test eject 100 μl of solution. The filling pipette system is now ready and should be kept at 4°C.

315

316 **3.7. Turn on the rig and setup the acquisition system**

317 The recording software should be ready to play a pipette resistance test in voltage clamp, i.e.
318 short (5 to 20 ms) voltage steps (-2 to -10 mV) repeated at high frequency (~20 Hz).

319

320 **3.8. Set the perfusion and temperature of the recording chamber**

321 Continuously perfuse ACSF warmed at 35-37°C and bubbled with 95/5% O₂/CO₂ through to the
322 recording chamber (2-5 ml/min). The output flow from the chamber can be directed to the
323 same container to recycle the ACSF. Turn on the closed-loop heating unit to maintain the ASCF
324 in the chamber at the desired temperature (35°C, see **Note 6**).

325

326 **3.9. Place the slice in the recording chamber**

327 Place the slice in the recording chamber, then place the slice holding harp over the slice to
328 maintain it. The ASCF perfusion (and the closed loop heating unit) can be shortly paused during
329 this manipulation (but see **Note 6**).

330

331 **3.10. Patching – step by step**

- 332 1. Identify a cell to patch under the 60x objective (see **Note 7**).
333 2. Fill approximately $\frac{3}{4}$ of a patch pipette with the internal solution, using the syringe with
334 the microloader (Fig. 4). Place the pipette in the pipette holder, secure the
335 micromanipulator to an appropriate starting position, and apply positive pressure using
336 a syringe or a mouth blow.
337 3. Move up the objective to make some space between the slice and the objective until a
338 column of liquid starts forming under the lens. Use the micromanipulator to position the
339 pipette tip in the center of the column of liquid under the lens. If well aligned at the
340 beginning, the pipette should be well under the lens, maybe unfocused at first.
341 4. The positive pressure exerted to the pipette results in an outflow of internal solution
342 from the pipette and should be visible while focusing on the pipette tip. The pipette tip
343 should be clean. If necessary, you may increase the pressure transiently to get rid of any
344 dust particles, or change pipette.
345 5. Start the pipette resistance test on the software (-2 mV at 20 Hz, 50 ms ON – 50 ms
346 OFF). As response to the voltage step, a current jump should be visible and
347 proportionate to the pipette resistance (Figure 6A, right). Check that the resistance is
348 appropriate (3-8 M Ω) and adjust the pipette offset to 0 pA. Lower the objective and
349 then the pipette in small steps, until the slice surface is in focus.
350 6. Approach the cell in a movement that follows as much as possible the axis of the
351 pipette, limiting lateral movements or lesions of the tissue. The positive pressure should
352 be sufficient to push aside the brain slice tissue in front of the pipette tip and 'clean' the
353 cell surface.
354 7. When pushing the pipette tip against the cell body, a "dimple" appears on the
355 membrane (Figure 6A).
356 8. Form a giga-ohm seal by releasing the pressure and apply gentle and transient negative
357 pressure (Figure 6B). The steady state current response to the pulse should now be
358 close to 0 pA, indicating a cell-attached configuration and a seal resistance of 1 G Ω or
359 higher.
360 9. Release any pressure to the pipette.
361 10. Apply a -65 mV holding potential. Set the test pulse amplitude to -10 mV and its
362 frequency to 100 Hz (10 ms ON – 10 ms OFF).
363 11. Compensate for fast and slow pipette capacitance transients [17].
364 12. Break in by exerting a quick negative pressure ("kissing" the syringe, shy at first, then
365 vigorously if needed) to establish whole cell configuration (Figure 6C).

366
367
368 [Figure 6 – patching step by step]
369

370 **3.11. Recording two cells**

- 371 1. If two cells need to be recorded, approach the cells with 2 patch pipettes, one coming
372 from the left, the other from the right side (see **Note 8**).
373 2. Approach each pipette tip close to its target neuron (less than 100 μ m distance), before
374 establishing a seal onto one neuron and then onto the other neuron. Once good quality
375 giga-seals have been established, break in one cell then in the other.

376

377 **3.12. Artefact compensation**

378 Single pipette patch clamp generates aberrations that should be corrected in order to read
379 proper signals and minimize the effect of the recording on the cell activity [18][19]. Instructions
380 for pipette capacitance compensation and neutralization of artefacts are given in the
381 Multiclamp 700B manual
382 (https://mdc.custhelp.com/euf/assets/content/MultiClamp_700B_Manual2.pdf).

383 We routinely use the bridge balance compensation in current clamp recordings. This can be
384 achieved by using the “auto” bridge balance. For manually adjusting bridge balance, bypass
385 filtering, and repeatedly inject a high amplitude negative current of brief duration (e. g. - 2 nA
386 during 0.5 ms at 30 Hz). Increase bridge balance compensation to roughly two-and-a-half times
387 the pipette resistance. Increase the capacitance compensation as needed; in presubicular
388 neurons the final values are typically around 7 to 9 pF. Bridge balance and capacitance
389 compensation need to be increased alternately and iteratively, under visual control of the
390 voltage response. Stop increasing further just before oscillations become apparent. Enable the
391 functionality ‘disable if oscillation detected’ (check box) to protect against unwarranted
392 changes of recording quality during the recording that may lead to oscillations and cell loss.

393

394 **3.13. Resting membrane potential**

- 395 1. Once the recording mode has been switch to current clamp, make sure that the current
396 command is set to zero and record the membrane potential for a few minutes.
- 397 2. At the beginning of the recording, the membrane potential may gradually drift before
398 stabilizing after several minutes of whole cell recording. Membrane potential should be
399 determined when the potential is stable (see **Note 9**).

400

401 **3.14. Intrinsic electrophysiological properties**

- 402 1. Use hyperpolarizing and depolarizing step current injections to determine intrinsic
403 properties
- 404 2. The cell can be either held at its resting potential (V_{rest} , more physiological) or at a
405 standardized potential (easier for comparison between cells, standardize to the
406 population average of V_{rest}), and apply current steps of 0.8 sec every 5 seconds (Fig. 7;
407 see **Note 10**).
- 408 3. Start with a negative step current injection allowing a steady state hyperpolarization to
409 around -105 mV (if the cell can handle it) and increase incrementally during the
410 successive steps toward positive values leading to action potential firing, and until
411 depolarization block.
- 412 4. The incremental current steps should be small, so as to cover the range of potentials
413 with a precise resolution. Especially, the first current triggering an action potential
414 should be subtly approached (see **Note 10**) – this will indicate the rheobase. The final
415 level of injected current should lead to a total or partial depolarization block, to make
416 sure that most of the cell’s response range has been explored, until the maximum firing
417 rate and beyond.
- 418 5. Some of the intrinsic neuronal properties such as the resistance and capacitance, as well
419 as the firing pattern or action potential waveforms can be easily determined from this

420 kind of all-in-one protocols (cf. [12][13], for more details about the analyses).

421
422
423
424

[Figure 7 - intrinsic]

425 **3.15. Dual recordings: synaptic connectivity and dynamics**

- 426 1. Testing the connectivity of cell pairs can be done either in current clamp or in voltage
427 clamp (see **Note 11**). Choose the recording configuration according to your
428 experimental question, the context of the experiments and the subsequent analyses
429 [14].
- 430 2. Trigger individual action potentials/currents by injecting a brief high amplitude current
431 (depending on the input resistance of the cell, about 1 - 2 nA during 1 ms), or by holding
432 the potential around 0 - 20 mV for 0.5 ms (Fig. 8). Action potentials/currents may be
433 initiated alternately in the two cells and the responses should be observed in the
434 putative postsynaptic cell held at the appropriate voltage/potential. Repeat this
435 protocol 100 times in order to determine the probability of neurotransmitter release vs
436 failure rate, and the average amplitude and variability of the postsynaptic events.
- 437 3. Determine the paired pulse ratio with successive stimulations (paired pulse stimulation)
438 repeated at 20 or 50 Hz.
- 439 4. There may be a need to probe synaptic transmission using trains of 10 or 30 repeated
440 stimulations at moderate to high frequency. Some central synapses are rather
441 inefficient in releasing neurotransmitter – in this case, strong repeated stimulation is the
442 most appropriate way to detect the functional connectivity between two cells [14].

443
444
445
446

[Figure 8 - pairs]

447 **3.16. Afferent connectivity: Optogenetics combined with patch clamp recording**

- 448 1. Use virus-mediated channelrhodopsin expression in upstream brain areas to study long-
449 range afferent innervation with photostimulation in brain slices. We have obtained
450 reliable results with a AAV2/5 serotype expressing Chronos, a fast channelrhodospin-2
451 variant, fused to green fluorescent protein under the control of the Synapsin promoter:
452 AAV5.Syn.Chronos-GFP.WPRE.bGH (see **Note 12**).
- 453 2. To investigate projection neuron circuits, prepare brain slices for patch clamp recording
454 of the postsynaptically connected neurons, after a suitable time for transgene
455 expression. Choose a slice that contain Chronos expressing axon terminals by visualizing
456 the fluorescent reporter GFP, using a hand held flashlight and appropriate glasses
457 (Nightsea DFP-1; see **Note 12**).
- 458 3. Transfer the slice into the recording chamber. Briefly illuminate the slice with the blue
459 LED via the objective to identify a zone with GFP+ fibers. Choose a principal neuron in
460 that zone for patch clamp recording.
- 461 4. Establish a whole cell recording as described above in section 3.10, using a K-gluconate
462 based internal solution.
- 463 5. Record in current clamp configuration, holding the neuron at its resting membrane

464 potential, usually close to -65 mV. Stimulate afferent fibers with brief pulses of blue
465 light whole field illumination (470 nm LED). Start using 0.5 ms duration and 0.1 mW light
466 intensity. If no responses are observed, the light intensity may be increase as needed up
467 to 2 mW [15]. Duration may be increased to 2 ms (see **Note 13**). For strong synaptic
468 connections and strong illumination, postsynaptic actions potentials will be initiated
469 (Fig. 9).

- 470 6. Postsynaptic responses may also be recorded in voltage clamp configuration, with a
471 holding potential of -65 mV. Figure 9C shows the response of a presubicular neuron to
472 activation of thalamic fibers with a 2 ms light pulse, and Fig. 9D shows depressing
473 response dynamics for a train of 5 pulses.
- 474 7. Record from two putative postsynaptic neuron types at the same time to compare the
475 strength (amplitudes) and dynamics of afferent inputs to different cell types in the same
476 brain area. Double recordings allow standardization across animals and across slices, for
477 varying levels of Channelrhodopsin expression [15].
- 478 8. Use pharmacology to identify the neurotransmitter that is being released (ie., APV +
479 NBQX should block responses of glutamatergic synapses. Cf. Table 3)
- 480 9. Determine response latencies during offline analysis. Response latencies for
481 monosynaptic connections are typically between 0.5 and 4 ms. Longer latency
482 responses may be due to indirect activation of the recorded neuron via the local
483 microcircuit (see **Note 14**).

484

485 [Figure 9 – long range functional connectivity using optogenetics]

486

487

488 **3.17. Anatomy**

489 For recovering cellular anatomy, the recorded cells must be unpatched carefully and the slice
490 should be processed according to standard protocols described previously ([13]; see **Note 15**).

491

492 4. Notes

493

494 1. External solutions.

495 The choice of the cutting solution might depend on the animals' age (NaCl/Sucrose, ACSF,
496 choline Chloride, NMDG. Additional recipes are available on
497 <https://www.brainslicemethods.com/> and [20].

498

499 We obtained similar results with Choline-chloride based or NaCl/Sucrose based cutting solution
500 for adult animals (from p35 to p60). Replacing sodium ions, increasing Mg^{2+} and decreasing Ca^{2+}
501 during the cutting procedure protects the brain tissue from excitotoxicity. In addition, low
502 temperature is critical as cooling slows down metabolism.

503 ACSF is designed to mimic the composition of the cerebrospinal fluid. The amount of divalent
504 cations (Ca^{2+} and Mg^{2+}) may be adjusted to modify excitability of neurons, ie. by lowering $MgCl_2$
505 to 1.8 or increasing $CaCl_2$ to 2.2 or up to 4 mM. This will also affect firing threshold and
506 neurotransmitter release. Increasing K^+ will lead to more depolarized resting potential [5].

507

508 2. Internal solutions

509 The K-Gluc solution is close to the composition of the cell's interior and is useful to study
510 neuronal active and passive properties or responses to synaptic input.

511 Low chloride in the internal solutions keeps the equilibrium potential of chloride low (around -
512 75 mV). The reversal potential can be calculated using the Nernst equation, and measured
513 experimentally by varying the holding potential while activating $GABA_A$ receptors. Excitatory
514 postsynaptic potentials can be recorded at around -65 mV (Figure 8C-F; [14]).

515 Note that EGTA, a slow calcium chelator, may be increased up to 10 mM, to help prevent
516 excitotoxicity due to increase in intracellular calcium. However, EGTA influences calcium
517 dynamics and intracellular calcium signaling, and therefore we preferred low EGTA in our
518 experiments. Mg-ATP, Tris-ATP and Na_2 -phosphocreatine provide sources of energy and second
519 messengers, while they are not critical for successful patching.

520

521 The Cs-Gluc solution contains cesium as the main cation. Therefore it cannot be used to study
522 action potentials in current clamp, because cesium blocks potassium currents necessary for
523 membrane repolarization. In voltage clamp configuration, Cs-gluconate improves space clamp
524 issues, by reducing leak K conductances. However only the perisomatic area can be controlled
525 [21], while currents generated very distally are clamped after passive or active integration by
526 the dendritic tree. Outward inhibitory postsynaptic currents can be recorded by clamping the
527 membrane potential at +40 mV (Figure 8B; [14]).

528

529 3. Anesthesia

530 Make sure to obtain the necessary permissions for animal experimentation and follow local
531 guidelines. The anesthesia will slow down the breathing of the animal. The breathing frequency
532 of a mouse normally ranges from 80 to more than 200 breaths per minute. Anesthesia should
533 slow it down to 20 to 40 breaths per minute. Test pain reflexes (hind paw pinch) to determine
534 whether the anesthesia is deep enough.

535

536 **4. Slice Thickness and cutting direction**

537 Slice thickness depends on many factors, including the area of interest, age of animals, the
538 scientific question, and the exact configuration of the setup. We preferred thick 300 μm slices
539 (as thick as possible while still assuring good oxygenation), to largely preserve local connections
540 and neuron integrity. For presubicular slices, it is preferable that the blade runs from the caudal
541 to the rostral part of the cerebrum, attacking the cut at the level of the entorhinal cortex.

542

543 **5. Pipettes**

544 Glass capillaries with a filament are recommended for easy filling of the tip. Thick walled glass
545 (1.5 mm O.D. and 0.86 mm I.D.) allows for low noise recordings. The pipette shape and
546 resistance depends the targeted cells (soma size, elasticity of the membrane) but also on the
547 space constraints of the recording setup. For instance, choose long tapers if the lens should be
548 moved after patching (e. g. to adjust the light stimulation location) to minimize the risk of
549 possible collision of the lens with the pipette.

550

551 **6. Temperature of the recording chamber**

552 Temperature control is important for slice quality, and also for ion channel biophysics. Channel
553 kinetics and thus action potentials are slowed at room temperature. Any change in the flow
554 speed might result in a transient change in the chamber temperature, rapidly compensated by
555 the closed loop heating device. We recommend turning off the heating system if the ASCF
556 perfusion is transiently interrupt to avoid a transient overheating of the chamber when the
557 perfusion is turned back on.

558

559 **7. Finding the right cell to patch**

560 The cell should be as deep as the optic allows it. Patching very superficial cells is easier, but the
561 chance to record from neurons with cut neurites is higher, and might results in recording
562 intrinsic properties or synaptic connectivity from damaged neurons with incomplete
563 morphology. Transgenic mouse lines may be useful to target genetically defined subpopulations
564 of neurons with a somatically expressed fluorescent reporter protein.

565

566 [Figure 10: cells to patch]

567

568 **8. Double patch recordings**

569 Coarse movements of the micromanipulators may give rise to vibrations and are more safely
570 carried out before establishing a recording. This is recommended to avoid movements of a
571 pipette in the slice while a seal has already been established, and to reduce the risk of loosing a
572 cell due to movement of the brain tissue. Sometimes a second attempt becomes necessary
573 while one neuron is already in cell-attached or whole-cell recording configuration. It's always
574 worth a try!

575

576 **9. Junction potentials**

577 It is surprisingly tricky to measure the true membrane potential due to various junction
578 potentials. A noninvasive study of membrane potential using the K^+ current reversal potential in

579 cell attached configuration gave values more negative by 13 mV compared to membrane
580 potential measures from the same neurons in whole cell recordings [22][5]. This is probably due
581 to a Donnan equilibrium potential between pipette and cytoplasm (reviewed in [23]. See also
582 [17]).

583

584 **10. Assessing intrinsic properties using current step injections in current clamp**

585 The length of the current step can be adjusted, depending on the cells or on the question. To
586 study firing adaptation over long time periods it may be useful to apply current steps for 2
587 seconds or more [12].

588 The time interval between step current injections is chosen depending on the time that the
589 membrane potential needs to stabilize to the baseline value. Injecting negative current may
590 result in a depolarizing rebound and vice versa. The longer the interval the better, but of course
591 long intervals increase the experiment duration.

592 If the aim of the current injection protocol is to define the input/output or frequency/intensity
593 function of the neurons, the resolution of the current step protocol (ie. the amplitude
594 difference between successive current steps) should be set optimally to avoid inaccuracy. The
595 number of action potentials fired is plotted against the injected current to determine the
596 threshold current and the neuronal gain [12][13]. If the difference between the incremental
597 current steps is too high, the experimentally determined threshold current may be
598 overestimated. Alternatively the rheobase can be estimated by linear extrapolation [24].

599

600 **11. Experimental conditions for pair recordings**

601 Choose your experimental condition appropriately. For example, studying the dynamic
602 properties of GABAergic synapses (GABA-A) might require a different internal solution and
603 holding potential than focusing on glutamatergic synapses [14]. On the other hand, a Cs-based
604 solution for pair recordings precludes studying intrinsic properties.

605 The whole cell current clamp or voltage clamp configuration may be used. Voltage clamp is
606 fraught with error in central neurons because of the complexity and length of their dendritic
607 tree preventing a proper clamp of the voltage [21]. Somatic voltage clamp can still be useful to
608 detect postsynaptic currents even though current kinetics from distant input may be distorted.
609 Current clamp recordings of postsynaptic potentials will reveal somatic EPSP shape. EPSP
610 duration is longer than that of postsynaptic currents, and EPSPs may sum depending on the
611 stimulation frequency. Current clamp recording will allow to detect amplifying currents of the
612 perisomatic region, that would otherwise be clamped in voltage clamp configuration [25]. Dual
613 recordings can also be used to study indirect connectivity [26]

614

615 **12. Optogenetics**

616 Viruses can be purchased from Addgene. Methods for intracerebral stereotaxic viral injections
617 have been described in detail [27]. Work in low light during slicing to avoid ChR2 excitotoxicity.
618 Store slices in the dark. When illuminating the slice under the microscope, use infrared light as
619 much as possible. Illumination with blue LED light will be necessary to localize the zone
620 containing GFP+ axons, but this will also activate the ChR2 at the same time, so the illumination
621 time should be as short as possible (no more than a few seconds).

622

623
624
625
626
627
628
629
630
631
632
633
634
635
636
637
638
639
640
641
642
643
644
645
646
647
648
649
650
651

13. Photostimulation

To determine the light intensity under the objective, use a powermeter (Thorlabs PM100D). Chronos is very light sensitive and should respond to brief and low intensity illumination at 470 nm. Depending on the number of transfected afferent fibers present in the slice, and the strength of the synaptic connection, higher light intensities may be required to give detectable postsynaptic responses. Due to variability of efficiency of viral transfections, the range of useful photostimulation intensities should be carefully determined for each animal and each slice [15]. More fibers will be recruited for stronger light stimulations.

14. Direct monosynaptic connectivity or not?

A pharmacological trick to identify monosynaptic responses following light stimulation consists in the application of TTX (1 μ M) – which should decrease or abolish action potential dependent postsynaptic responses – followed by the addition of 4-AP (100 μ M; Table 3). 4-AP will enhance Channelrhodopsin induced depolarization of presynaptic terminals, and so help neurotransmitter release and reestablish postsynaptic responses. Increasing the light intensity in the TTX/4-AP condition may help. If in the presence of TTX/4-AP photoinduced postsynaptic responses are detected, with latencies > 0.5 ms, the connection is monosynaptic.

Note: If the photostimulation leads to immediate (less than 0.5 ms delay) responses in the recorded neuron, it is likely that the recorded neuron itself expresses channelrhodopsin. In this case, the response will persist in the presence of TTX. For prolonged illumination of 500 ms duration, the response will last as long as the illumination (see [15], Figure 1F).

15. Cellular anatomy

A few minutes in whole cell configuration are enough for filling the dendritic tree and the axon. Higher concentrations of biocytin may be used if the complete morphological recovery is critical [28].

652 ACKNOWLEDGMENTS:

653 This work was supported by the Humboldt Universiteat zu Berlin, Bernstein Center For
654 Computational Neuroscience and Deutsche Forschungsgemeinschaft BR 3479/12-1 (J.S.), the
655 French Ministry for Education and Research (L.R.) and Agence Nationale de la Recherche Grant
656 ANR-18-CE92-0051-01 (D.F.).

657

658 DISCLOSURES:

659 The authors declare no competing financial interests.

660

661

662 REFERENCES:

663

664 1. Neher E, Sakmann B (1976) Single-channel currents recorded from membrane of
665 denervated frog muscle fibres. *Nature* 260:799–802. <https://doi.org/10.1038/260799a0>

666 2. Hamill OP, Marty A, Neher E, et al (1981) Improved patch-clamp techniques for high-
667 resolution current recording from cells and cell-free membrane patches. *Pflugers Arch*
668 391:85–100

669 3. Ogden DD, Stanfield PR (1999) Chapter 4 Patch clamp techniques for single channel and
670 whole-cell recording

671 4. Llinás RR (1988) The intrinsic electrophysiological properties of mammalian neurons:
672 insights into central nervous system function. *Science* 242:1654–1664.
673 <https://doi.org/10.1126/science.3059497>

674 5. Fricker D, Verheugen JAH, Miles R (1999) Cell-attached measurements of the firing
675 threshold of rat hippocampal neurones. *The Journal of Physiology* 517:791–804.
676 <https://doi.org/10.1111/j.1469-7793.1999.0791s.x>

677 6. Pastoll H, Ramsden HL, Nolan MF (2012) Intrinsic electrophysiological properties of
678 entorhinal cortex stellate cells and their contribution to grid cell firing fields. *Front Neural*
679 *Circuits* 6:17. <https://doi.org/10.3389/fncir.2012.00017>

680 7. Alonso A, Klink R (1993) Differential electroresponsiveness of stellate and pyramidal-like
681 cells of medial entorhinal cortex layer II. *J Neurophysiol* 70:128–143.
682 <https://doi.org/10.1152/jn.1993.70.1.128>

683 8. Stell BM, Rostaing P, Triller A, Marty A (2007) Activation of Presynaptic GABA_A Receptors
684 Induces Glutamate Release from Parallel Fiber Synapses. *J Neurosci* 27:9022.
685 <https://doi.org/10.1523/JNEUROSCI.1954-07.2007>

686 9. Epsztein J, Brecht M, Lee AK (2011) Intracellular determinants of hippocampal CA1 place
687 and silent cell activity in a novel environment. *Neuron* 70:109–120.
688 <https://doi.org/10.1016/j.neuron.2011.03.006>

- 689 10. Fricker D, Dinocourt C, Eugène E, et al (2009) Pyramidal cells of rodent presubiculum
690 express a tetrodotoxin-insensitive Na⁺ current. *J Physiol (Lond)* 587:4249–4264.
691 <https://doi.org/10.1113/jphysiol.2009.175349>
- 692 11. Huang L-W, Simonnet J, Nassar M, et al (2017) Laminar Localization and Projection-Specific
693 Properties of Presubicular Neurons Targeting the Lateral Mammillary Nucleus, Thalamus, or
694 Medial Entorhinal Cortex. *eneuro* 4:ENEURO.0370-16.2017.
695 <https://doi.org/10.1523/ENEURO.0370-16.2017>
- 696 12. Simonnet J, Eugène E, Cohen I, et al (2013) Cellular neuroanatomy of rat presubiculum. *Eur*
697 *J Neurosci* 37:583–597. <https://doi.org/10.1111/ejn.12065>
- 698 13. Nassar M, Simonnet J, Lofredi R, et al (2015) Diversity and overlap of parvalbumin and
699 somatostatin expressing interneurons in mouse presubiculum. *Front Neural Circuits* 9:20.
700 <https://doi.org/10.3389/fncir.2015.00020>
- 701 14. Simonnet J, Nassar M, Stella F, et al (2017) Activity dependent feedback inhibition may
702 maintain head direction signals in mouse presubiculum. *Nat Commun* 8:16032.
703 <https://doi.org/10.1038/ncomms16032>
- 704 15. Nassar M, Simonnet J, Huang L-W, et al (2018) Anterior Thalamic Excitation and
705 Feedforward Inhibition of Presubicular Neurons Projecting to Medial Entorhinal Cortex. *J*
706 *Neurosci* 38:6411–6425. <https://doi.org/10.1523/JNEUROSCI.0014-18.2018>
- 707 16. Penner R (1995) A Practical Guide to Patch Clamping. In: Sakmann B, Neher E (eds) *Single-*
708 *Channel Recording*. Springer US, Boston, MA, pp 3–30
- 709 17. Marty A, Neher E (1995) Tight-seal whole-cell recording. In: *Single Channel Recording*,
710 Plenum Press. Sakman, B. & Neher, E., New York, pp 31–52
- 711 18. Molecular Devices (2012) *The Axon Guide*
- 712 19. Barbour B (2014) *Electronics for electrophysiologists*
- 713 20. Ting JT, Daigle TL, Chen Q, Feng G (2014) Acute Brain Slice Methods for Adult and Aging
714 Animals: Application of Targeted Patch Clamp Analysis and Optogenetics. In: Martina M,
715 Taverna S (eds) *Patch-Clamp Methods and Protocols*. Springer New York, New York, NY, pp
716 221–242
- 717 21. Williams SR, Mitchell SJ (2008) Direct measurement of somatic voltage clamp errors in
718 central neurons. *Nat Neurosci* 11:790–798. <https://doi.org/10.1038/nn.2137>
- 719 22. Verheugen JA, Fricker D, Miles R (1999) Noninvasive measurements of the membrane
720 potential and GABAergic action in hippocampal interneurons. *J Neurosci* 19:2546–2555
- 721 23. Barry PH, Lynch JW (1991) Liquid junction potentials and small cell effects in patch-clamp

- 722 analysis. *J Membr Biol* 121:101–117
- 723 24. Altwegg-Boussac T, Chavez M, Mahon S, Charpier S (2014) Excitability and responsiveness
724 of rat barrel cortex neurons in the presence and absence of spontaneous synaptic activity in
725 vivo. *J Physiol (Lond)* 592:3577–3595. <https://doi.org/10.1113/jphysiol.2013.270561>
- 726 25. Fricker D, Miles R (2000) EPSP amplification and the precision of spike timing in
727 hippocampal neurons. *Neuron* 28:559–569
- 728 26. Silberberg G, Markram H (2007) Disynaptic inhibition between neocortical pyramidal cells
729 mediated by Martinotti cells. *Neuron* 53:735–746.
730 <https://doi.org/10.1016/j.neuron.2007.02.012>
- 731 27. Richevaux L, Schenberg L, Beraneck M, Fricker D (2019) Optogenetic stimulation of long-
732 range inputs and functional characterization of connectivity in patch-clamp recordings in
733 mouse brain slices. In: <https://www.biorxiv.org/>.
734 <https://www.biorxiv.org/content/10.1101/491563v1>. Accessed 12 Jul 2019
- 735 28. Jiang X, Wang G, Lee AJ, et al (2013) The organization of two new cortical interneuronal
736 circuits. *Nat Neurosci* 16:210–218. <https://doi.org/10.1038/nn.3305>
- 737
738
739

740 Figures and Tables

741

742 Table 1. Cutting solutions and ASCF composition in mM

<i>ref.</i>	Product	Choline-chloride	NaCl/Sucrose	ACSF
<i>Sigma - C7527</i>	Choline-chloride	110	/	/
<i>Sigma - S7653</i>	NaCl	/	125	124
<i>Sigma - S0389</i>	Sucrose	/	25	/
<i>Sigma - P4504</i>	KCl	2.5	2.5	2.5
<i>Sigma - S9638</i>	NaH₂PO₄	1.25	1.25	1
<i>Sigma - S5761</i>	NaHCO₃	25	25	26
<i>Sigma - G7528</i>	Glucose	7	2.5	11
<i>Fluka - 21114</i>	CaCl₂	0.5	0.1	2
<i>Fluka - 63020</i>	MgCl₂	7	7	2

743

744

745 Table 2. Internal solutions composition

<i>ref.</i>	Product	K-Gluc (mM)	For 25 ml	Cs-gluc (mM)	For 25 ml
<i>Sigma - G4500</i>	K-gluconate	140	819.7 mg	/	/
<i>Sigma - 232041</i>	Cs-OH	/	/	135	610.1 µl
<i>Sigma - G1951</i>	D-gluconic acid	/	/	135	1112.7 µl
<i>Sigma - P4504</i>	KCl	1.2	2.2 mg	5	9.3 mg
<i>Sigma - H3375</i>	HEPES	10	59.6 mg	10	59.6 mg
<i>Sigma - E4378</i>	EGTA	0 - 0.2	0 – 1.9 mg	0 - 0.2	0 – 1.9 mg
<i>Fluka - 63020</i>	1M MgCl₂	2	50 µl	2	50 µl
<i>Sigma - A9187</i>	MgATP	4	50.7 mg	4	50.7 mg
<i>Sigma - G9002</i>	Na₃-GTP	0.4	8.9 mg	0,4	8.9 mg
<i>Sigma - P7936</i>	Na Phosphocreatine	10	63.8 mg	10	63.8 mg
<i>Sigma - B4261</i>	Biocytin	3%	75 mg	3%	75 mg
	pH 7.2 – 7.4		K-OH or K-gluconate		Cs-OH or D-gluconic acid

746

747 Table 3. Drugs used for pharmacology experiments

<i>Ref.</i>	Product	Target	Stock (mM)	Use at (µM)	in 20 ml (µl)
<i>Tocris - 1078</i>	TTX	Voltage-gated Na ⁺ channels	1	1	20
<i>Sigma - A78403</i>	4-AP	Voltage-gated K ⁺ channels	100	100	20
<i>Tocris - 0106/1</i>	APV	NMDA receptors	50	100	40
<i>Tocris - 1044</i>	NBQX	AMPA/kainate receptors	10	10	20

748

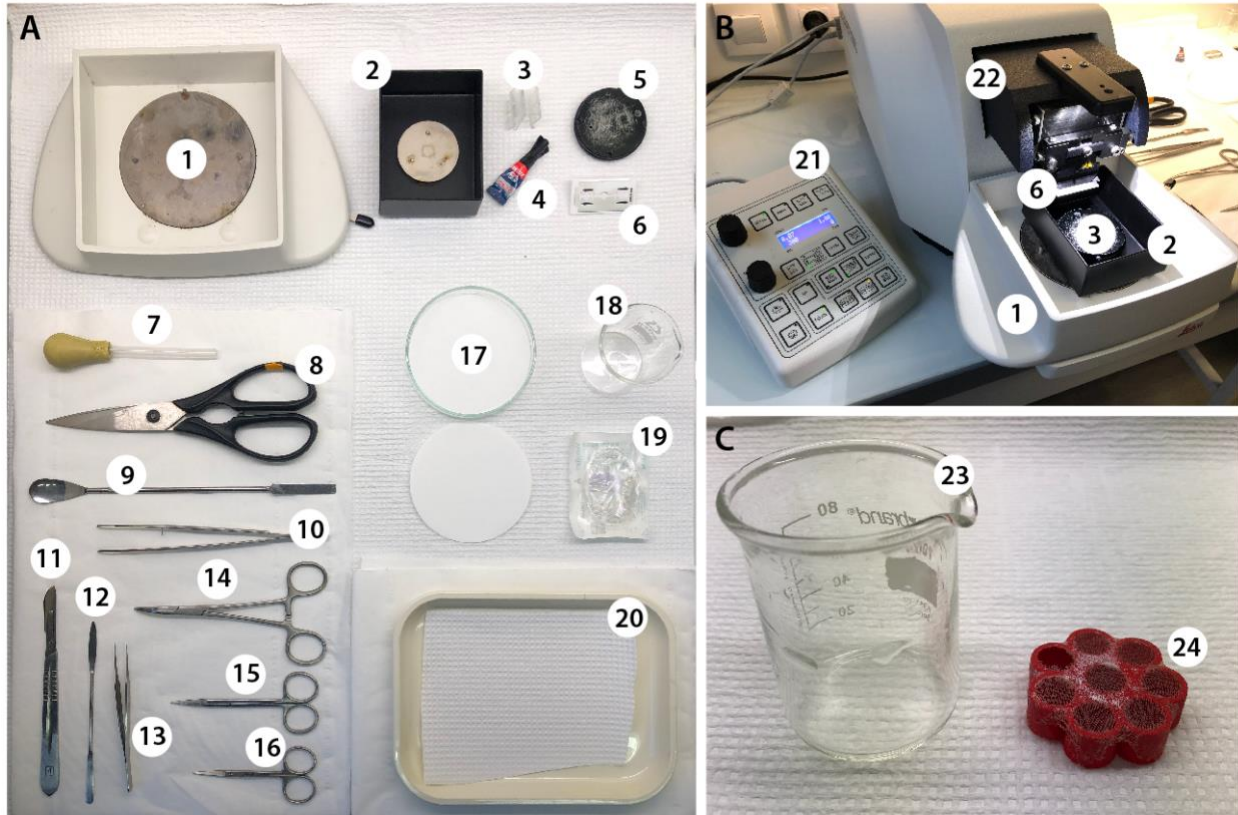

749
 750 **Figure 1. Dissection and slicing equipment.** **A.** **1,** Vibratome outer chamber, to be filled with
 751 crushed ice. **2,** Slicing chamber, to be filled with ice cold, oxygenated cutting solution. **3,** Tube
 752 holder for oxygenation. **4,** Superglue. **5,** Specimen holder. **6,** Double edge stainless steel blade,
 753 use one half for slicing. **7,** Transfer pipette. **8,** Big scissors. **9,** Big spatula. **10,** Curved forceps. **11,**
 754 Scalpel. **12,** Small round spatula. **13,** Dumont forceps. **14,** Curved hemostat. **15,** Medium
 755 scissors. **16,** Small scissors. **17,** Absorbent paper. **18,** 80 ml beaker. **19,** Butterfly needle with
 756 tubing. **20,** Versi-dry bench absorbent paper. **B.** **21,** Vibratome control panel. **22,** Leica VT1200S
 757 Vibratome. **C.** **23,** 80 ml beaker serving as slice storage chamber, with **24,** 3D printed slice
 758 support with stretched and glued nylon stocking.

759
 760

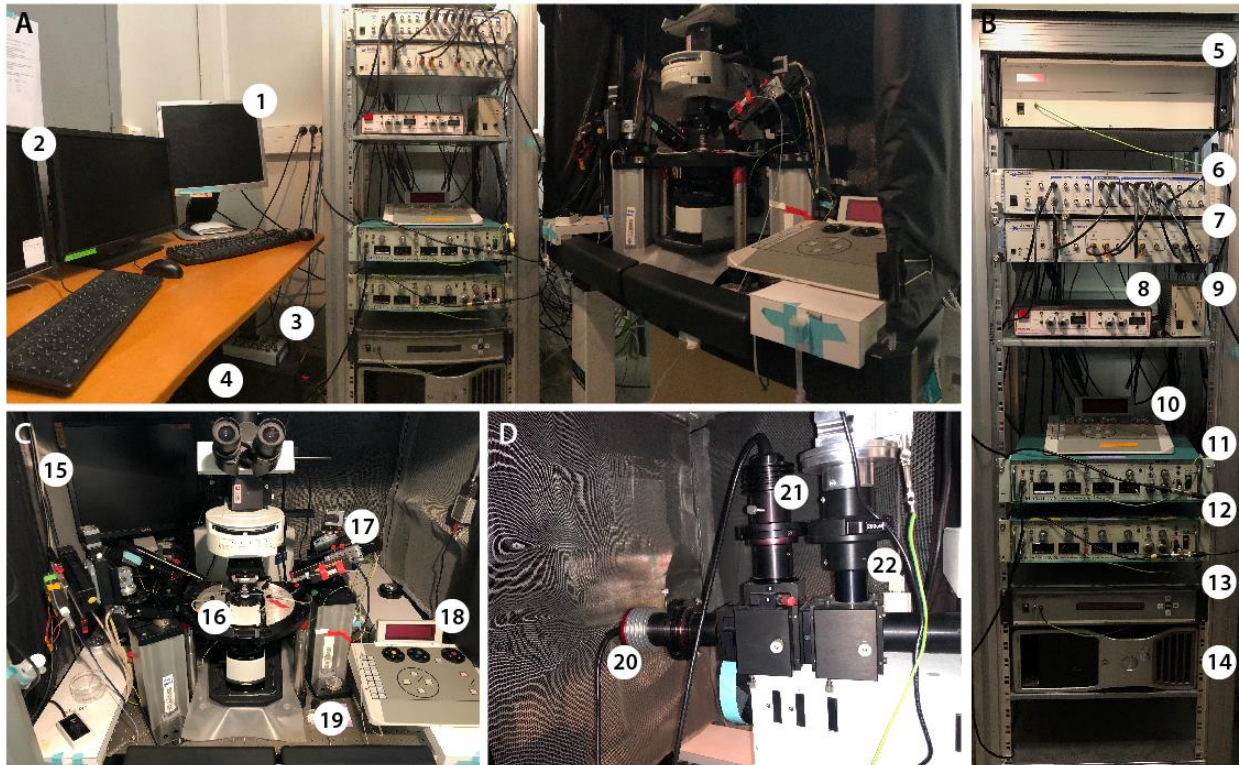

761

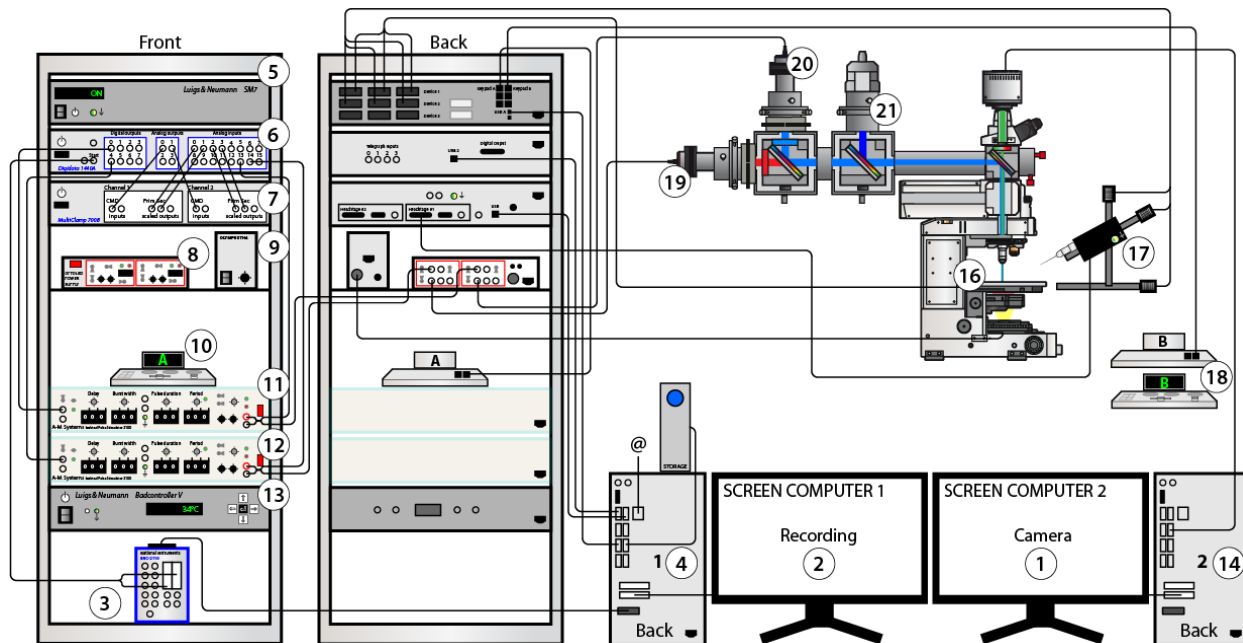

762

763 **Figure 2. Electrophysiology setup (top) and schematic (bottom).** A, Overview of experimental
 764 set-up. B, Electrophysiology instruments rack. C, Recording chamber and Olympus BX51WI
 765 microscope, mounted on a Luigs & Neumann shifting table. D, Back view of the microscope
 766 with Cairn triple port microscope coupling. 1, Camera screen. 2, Electrophysiology screen. 3,
 767 National Instruments BNC-2110. 4, Computer. 5, Luigs & Neumann SM7 micromanipulators
 768 controller. 6, Digidata 1440A, Molecular Devices. 7, Multiclamp 700B, Molecular Devices. 8,

769 Cairn Optoled Power Supply. **9**, Olympus TH4 power supply. **10**, Luigs & Neumann
 770 micromanipulator keypad (x-y shifting table and microscope focus axis control). **11**, A-M
 771 Systems isolated pulse stimulator 1. **12**, A-M Systems isolated pulse stimulator 2. **13**, Luigs &
 772 Neumann Badcontroller V bath temperature controller. **14**, Camera computer. **15**, Second
 773 camera screen. **16**, Recording chamber. **17**, Pipette holder and micromanipulator. **18**, Luigs &
 774 Neumann micromanipulator keypad (pipette holder controller). **19**, Antivibration table. **20-21**,
 775 Cairn LED. **22**, 405nm laser.

776
 777
 778
 779

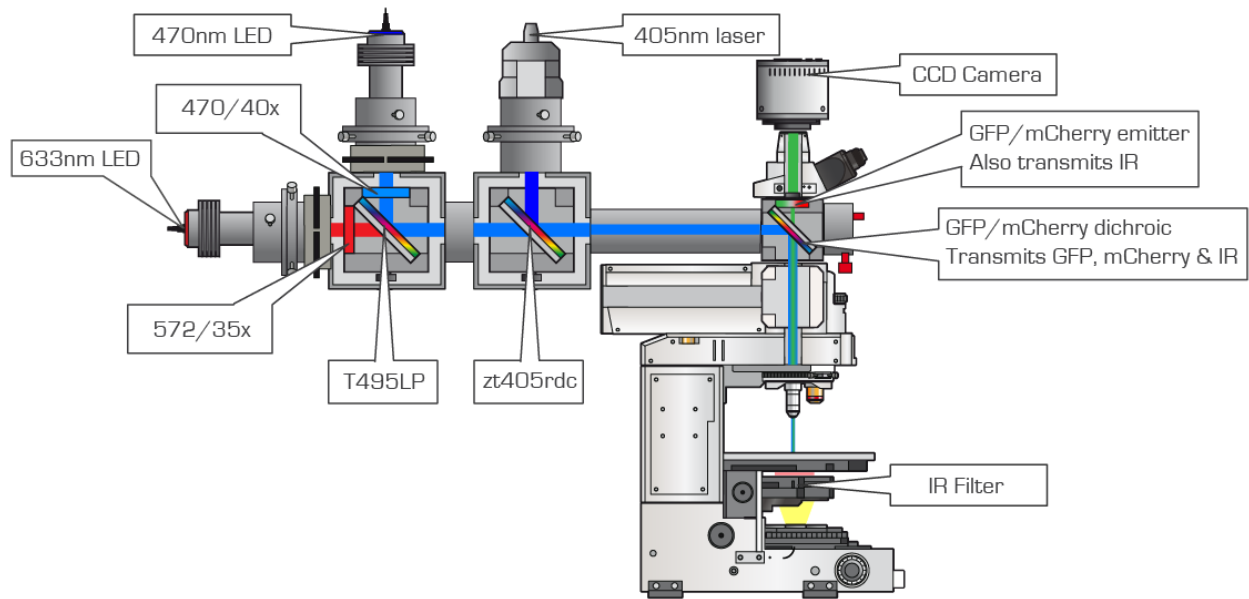

780
 781 **Figure 3. Microscope equipped for photostimulation.** Two LEDs for 470 nm or 633 nm whole
 782 field light stimulation are coupled into the epifluorescence port. Combined dual wavelength
 783 stimulation with a multiband dichroic. The third port accommodates a 405 nm laser for focal 1P
 784 photostimulation [15].

785
 786
 787

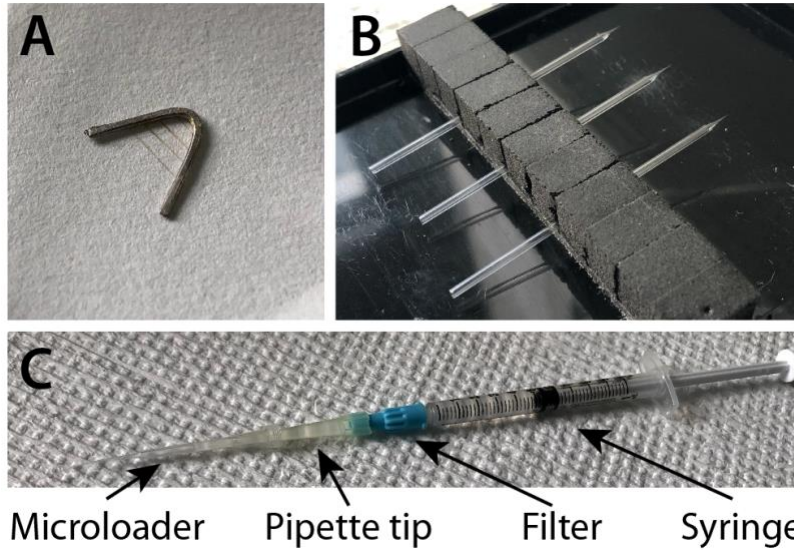

788
789
790
791
792

Figure 4. Electrophysiology accessories. A, Slice holding harp made of platinum wire and nylon stocking. B, three borosilicate glass patch pipettes. C, Pipette filling system with microloader.

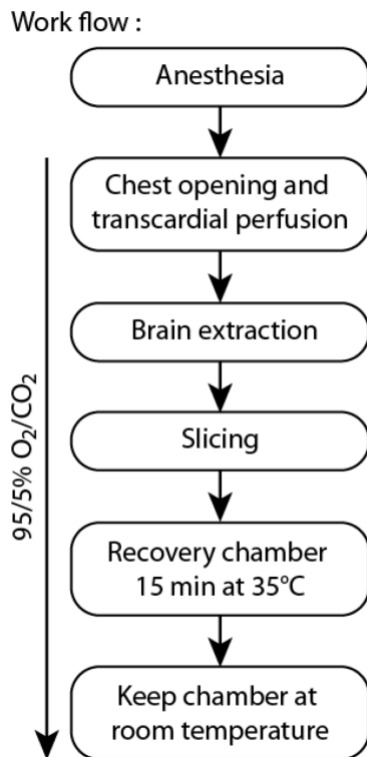

793
794
795
796

Figure 5. Experimental workflow.

797

798

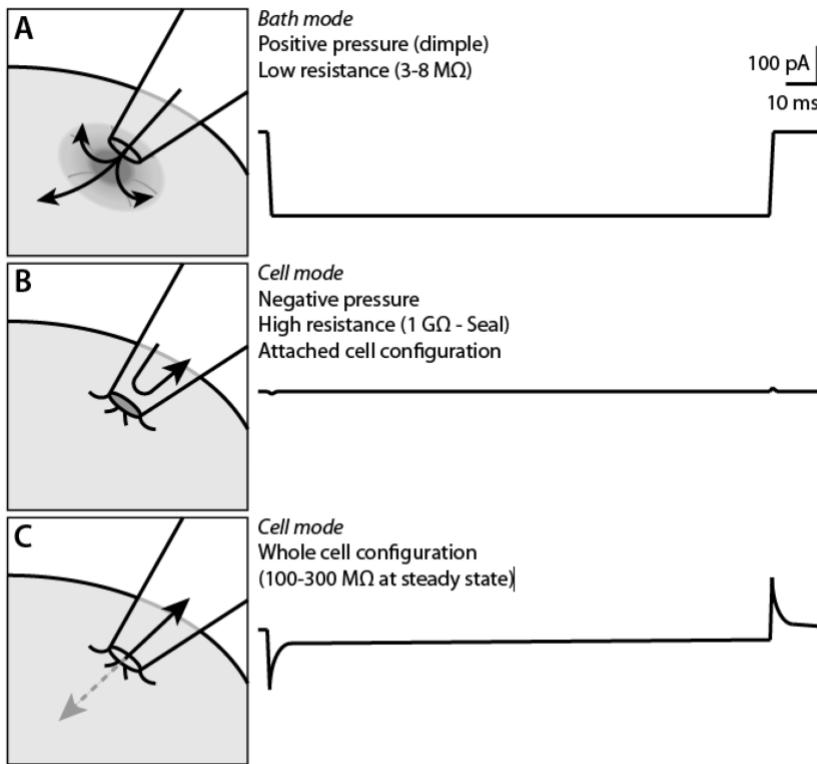

799

800 **Figure 6. Step-by-step schematic of patch-clamp.** Left, Illustration, right, corresponding traces
801 in voltage-clamp mode. **A**, Pipette approaching a neuron and forming a "dimple". Applying -2
802 mV voltage. Current jump between pipette and bath indicates pipette resistance. **B**, Positive
803 pressure is released, and negative pressure applied, resulting in seal formation between pipette
804 tip and neuronal membrane. Continue to monitor resistance, until formation of a high
805 resistance giga-seal between pipette and cell. **C**, Quick negative pressure is used to rupture the
806 membrane patch under the pipette and break into the cell. Direct electrical access to the cell's
807 interior, and dialysis via the membrane opening between cell and pipette.

808

809

810

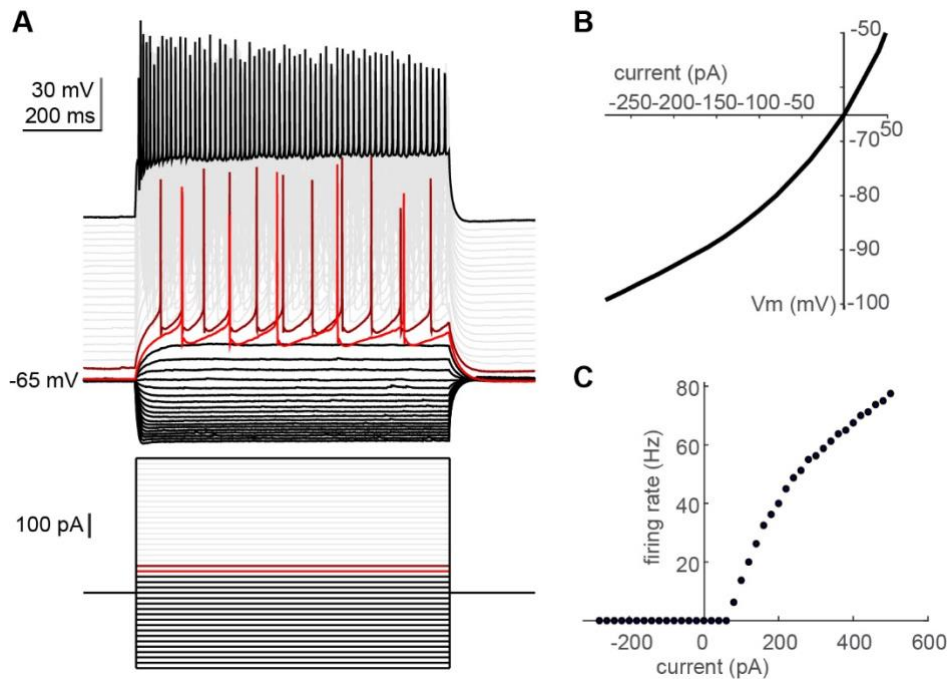

811

812 **Figure 7. Current step protocols reveal neuronal intrinsic properties.**

813 **A**, A presubicular cell recorded in whole cell configuration, from an acute adult mouse slice,
814 using a potassium gluconate based internal solution. The cell was recorded in current clamp
815 mode and maintained near its resting membrane potential at -65 mV. Current steps of 800 ms
816 duration were applied every 4 seconds (bottom), the first current step was -280 pA, with an
817 increment of 20 pA at each iteration, to reach +500 pA. The membrane potential
818 hyperpolarized as a response to negative current steps, and then depolarized for positive
819 current steps. The first step triggering action potentials (rheobase) is in light red, the second in
820 dark red. Subsequent steps are shown in light gray and the last step in black. (Steps with action
821 potentials are displayed with an incremental offset for clarity.) **B**, Corresponding IV-curve
822 (Current-Voltage), plotting voltage as a function of injected current, up to +50 pA. **C**,
823 Corresponding input/output curve of the spike frequency (number of evoked action potentials
824 per second) as a function of injected current. Rheobase is +80 pA.

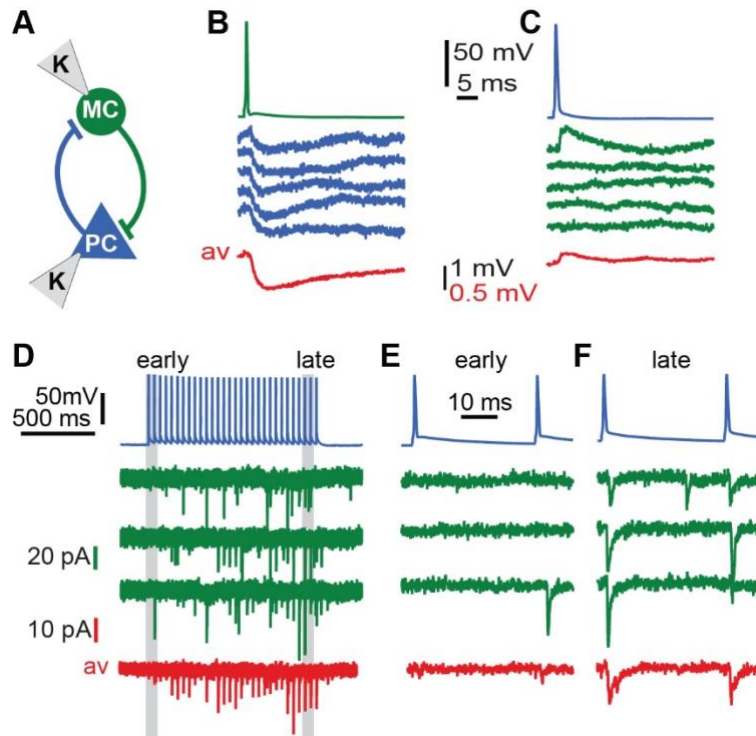

825
 826
 827
 828
 829
 830
 831
 832
 833
 834
 835
 836
 837
 838
 839
 840
 841
 842
 843
 844
 845
 846
 847
 848
 849
 850

Figure 8. Testing connectivity and synaptic dynamics using dual patch clamp recordings.

A, An excitatory pyramidal cell (PC) and an inhibitory Martinotti cell (MC) from the presubiculum were recorded simultaneously in the acute slice preparation of an adult mouse, using the potassium gluconate based solution with low chloride (5.2 mM; cf. Table 2). **B**, The connectivity from the Martinotti cell to the pyramidal cell was tested triggering a single action potential in Martinotti cell (Top, green trace) while recording the pyramidal cell in current clamp, maintaining its potential around -50 mV (bottom, 5 different trials (blue) and the average response (amplitude, -0.7 mV; red)). The Martinotti cell action potential reliably elicited inhibitory postsynaptic potentials in the pyramidal cell with short monosynaptic latencies (1-2ms). **C**, The connectivity from the pyramidal cell to the Martinotti cell was tested triggering single action potentials in the pyramidal cell (top, blue) while recording the Martinotti cell in current clamp, holding its potential around -65 mV (bottom, 5 different trials (green) and the average response (amplitude, 0.2 mV; red)). The pyramidal cell action potential did not reliably elicit excitatory postsynaptic potentials in the Martinotti cell initially. When a response was detected, it had a short monosynaptic latency (1-2 ms). **D**, The dynamics of the synaptic connection was tested using repeated stimulations of the pyramidal cell, with 30 spikes fired at 30 Hz. This stimulus train was repeated every 30 seconds (Top, blue). The postsynaptic Martinotti cell was recorded in voltage clamp holding its potential at -65 mV (bottom, 3 different trials (green) and the average response (red)). **E**, Spikes initiated early in the train only rarely evoked any postsynaptic response in the Martinotti cell. **F**, In contrast, the late spikes showed an increased efficacy in transmitting information. These protocols revealed the slow facilitating dynamics at the pyramidal cell to Martinotti cell synapse in the mouse presubiculum, a phenomenon that classic paired pulse stimulation would not have fully captured. Figure adapted from Simonnet et al. (2017) Nature Comms., with permission.

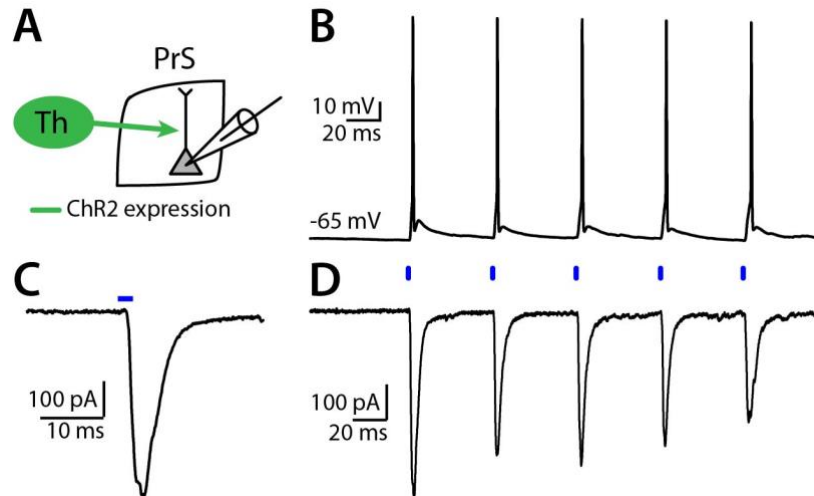

851
 852 **Figure 9. Photostimulation.**
 853 **A**, Schematic of ChR2 expressing thalamic (Th) afferents projecting to a presubicular (PrS)
 854 pyramidal cell recorded in whole-cell patch clamp. **B**, 20 Hz optogenetic activation (blue light)
 855 of thalamic afferents leads to action potential firing in the presubicular cell in current clamp
 856 mode. **C**, **D**, EPSC are evoked by the activation of thalamic afferents at 20 Hz. **C**, first evoked
 857 EPSP with a monosynaptic latency (< 2 ms) shown at a shorter time scale.

858
 859

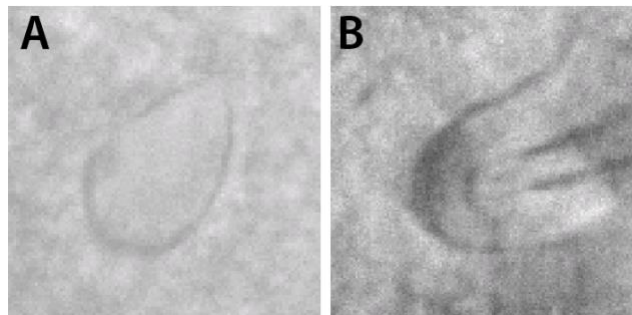

860
 861 **Figure 10. Examples of cells to patch.**
 862 **A**, A smooth, homogenous aspect of the cell surface, with low contrast, ideal for patching. **B**,
 863 Positive pressure producing a "dimple" at the surface of a cell.