



HAL
open science

USING X-RAY COMPUTED TOMOGRAPHY TO MEASURE FIRE DEGRADATION OF A TIMBER CONNECTION

Rostand Moutou Pitti, A. J. Huber Johannes, Hansson Lars, Rhoda Afriyie Mensah, Rodrigues Quentin

► **To cite this version:**

Rostand Moutou Pitti, A. J. Huber Johannes, Hansson Lars, Rhoda Afriyie Mensah, Rodrigues Quentin. USING X-RAY COMPUTED TOMOGRAPHY TO MEASURE FIRE DEGRADATION OF A TIMBER CONNECTION. World Conference on Timber Engineering, Université de Oslo, Jun 2023, Oslo (Norway), Norway. hal-04366356

HAL Id: hal-04366356

<https://hal.science/hal-04366356>

Submitted on 28 Dec 2023

HAL is a multi-disciplinary open access archive for the deposit and dissemination of scientific research documents, whether they are published or not. The documents may come from teaching and research institutions in France or abroad, or from public or private research centers.

L'archive ouverte pluridisciplinaire **HAL**, est destinée au dépôt et à la diffusion de documents scientifiques de niveau recherche, publiés ou non, émanant des établissements d'enseignement et de recherche français ou étrangers, des laboratoires publics ou privés.



USING X-RAY COMPUTED TOMOGRAPHY TO MEASURE FIRE DEGRADATION OF A TIMBER CONNECTION

Quentin Rodrigues¹, Johannes A. J. Huber², Lars Hansson³, Rhoda Afriyie Mensah⁴, Rostand Moutou Pitti⁵

ABSTRACT: The charring behaviour of timber elements under fire is well understood, however, the effects of fire and heat on connections are not equally well known. Timber connections often use steel fasteners, like screws or angle brackets, which conduct heat much better than wood. Moreover, these fasteners lose their mechanical resistance and capacity under elevated temperatures. X-ray computed tomography (CT) can be used to reconstruct the internal structure of wood non-destructively. It should therefore be possible to use this technology to also study the progressive degradation due to fire of a timber connection. The goal of the present study is to investigate how CT can be used to analyse the degradation of a timber connection due to fire. Samples of Norway spruce with self-tapping screws were scanned before and after a fire exposure, and mechanical tests were performed. The results indicate that the degradation due to fire in a timber connection can be observed in CT scans, but that certain measures need to be taken to minimise the effects of image artefacts due to X-ray scattering and photon starvation.

KEYWORDS: Steel-to-timber fastener, CT, Image artefacts, Image analysis, Density, Charring

1 INTRODUCTION

1.1 BACKGROUND

Connections are often the critical part of a building, since they establish structural continuity among the elements. Timber connections often use steel fasteners, like dowels or screws. The behaviour of timber elements under fire is well understood; charring occurs at a certain speed and the mechanical properties of unburnt timber close to the charring front remain unaffected [1]. Steel, however, behaves very differently under fire, due to its higher thermal conductivity and the tendency to soften under elevated temperatures. Timber connections using steel screws may therefore behave differently under fire than under normal conditions.

The Eurocode provides some recommendation to quantify timber resistance under fire and to passively improve the fire resistance of the connections [2]. It also provides us estimates about charring depth and the charring speed on fire exposed surfaces.

1.2 TIMBER CONNECTIONS UNDER FIRE EXPOSURE

Some studies have been conducted to investigate the mechanical resistance of timber connections using steel fasteners under a fire exposure. These experiments mainly focused on loaded samples. They provided insight on the impact of different parameters, like the position, dimension, and number of fasteners [3][4][5]. However, the conducted studies were only able to observe changes at the surfaces of the timber samples.

X-ray computed tomography (CT) enables non-destructive measurements of the internal density distribution of a scanned object. CT scanning has been used previously to investigate wood, e.g. to study density [6], shrinkage due to moisture changes [7] or for developing simulation models [8]. Since degradation of wood due to fire entails local reductions of density, CT scanning could provide insight on the evolution of this degradation. Furthermore, it could be used to study the degradation of wood in the proximity of a fastener *in situ*, from which the connection resistance could be estimated.

¹ Quentin Rodrigues, Université Clermont Auvergne, Clermont Auvergne INP, Institut Pascal, F-63000 Clermont-Ferrand, France, quentin.rodrigues.pro@gmail.com

² Johannes A. J. Huber, Luleå University of Technology, Skellefteå, Sweden, johannes.huber@ltu.se

³ Lars Hansson, Luleå University of Technology, Skellefteå, Sweden, lars.hansson@ltu.se

⁴ Rhoda Afriyie Mensah, Luleå University of Technology, Luleå, Sweden, rhoda.afriyie.mensah@ltu.se

⁵ Rostand Moutou Pitti, IRT, Libreville Gabon, Rostand.moutou_pitti@uca.fr

1.3 OBJECTIVE

The aim of the present study is to investigate how X-ray CT can be used to analyse the degradation of a timber connection due to a fire exposure. The results of this study provide insight in the possibilities and limitation of using CT to detect fire propagation in wood. The results can be used to prepare future studies using a designated combustions chamber, where timber charring will be studied *in situ* using a CT scanner.

2 CT SCANS AND ARTEFACTS

All CT scans in this study were acquired by a laboratory-adapted medical CT scanner (Siemens Somatom Emotion Duo) at the facilities of Luleå University of Technology in Skellefteå, Sweden. The images were acquired at locations spaced 1 mm apart and each slice contained a grid of 512×512 pixels, at a resolution of 0.68×0.68 mm².

An initial pre-study was conducted to evaluate the effects of metal connectors on the quality of the reconstructed images from CT scans.

2.1 METAL INDUCED ARTEFACTS

As shown in **Erreur! Source du renvoi introuvable.** **Figure 1**, the quality of an image obtained from the scan of a sample made of a piece of wood and a metal fastener is deteriorated by artefacts.

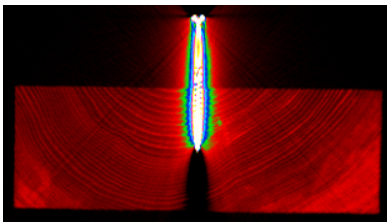

Figure 1: CT image from of a piece of wooden piece with a screw inserted parallel to the scanning plane.

We identified two main types of image artefacts. The first one causes the black part in **Figure 1** at the bottom of the screw and is due to photon starvation. It occurs when X-ray beams are attenuated after passing through material of too high density. The second artefact is visible in the proximity of the screw (blue and green on the figure) and is caused by photon deviation by the metal.

2.2 SETUP OPTIMIZATION TO REDUCE ARTEFACTS

Since photon starvation was caused by too large paths of metal in the emitter-sensor plane of the scanner, a first step to reduce artefacts without post-scan image correction was to scan the sample in a plane perpendicular to the screw axis. This way, the X-ray beams only need to pass through at most the diameter of the screw instead of its full length.

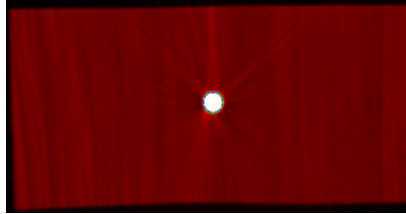

Figure 2: CT image from a wooden piece with a screw perpendicular to the scanning plane.

In **Figure 2**, much of the artefacts could be removed by a perpendicular screw orientation. Some bright streaks are still visible, but it does not affect the image quality substantially. In the proximity of the screw surface, some noise is also still visible, but substantially reduced compared to **Figure 1**.

2.3 SCAN WITH MORE METAL FASTENERS

Subsequently, scans have been performed on samples with a larger quantity of metal in the wooden sample to investigate the evolution of artefacts. In **Figure 3** the effects of two screws in the sample are shown. It was found that both type of artefacts were more visible in both sample orientations. Again it was found, that having the screw axes aligned with the scanning plane deteriorated the image quality more than having the screw axis oriented perpendicular to the scanning plane.

It becomes obvious that “tilting” the sample for better image quality has its limitations with more fasteners involved. Furthermore, it seems difficult to investigate setups with larger metal connectors, e.g. angle brackets.

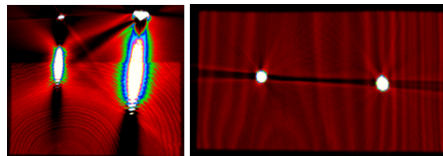

Figure 3: Comparison of the influence of the screw's positioning with two screws.

3 SAMPLE PREPARATION AND TESTS

3.1 SAMPLE GEOMETRY AND CT SCANS

Two types of samples have been used for our experiments, as illustrated in Figure 4 one for tests in compression on a wood screw (5×120 mm²) perpendicular to the fibres (tagged C- in the text), and one for tests in tension on a wood screw (5×70 mm²) parallel to the fibres (T-).

Twelve samples were produced for both sample types; 4 pieces were used as a reference (tagged T-0 and C-0), 4 were fire exposed for 5 minutes (tagged T- or C-5), and 4 were fire exposed for 10 minutes (tagged T- or C-10).

All samples were CT scanned before and after an eventual fire exposure with the screw inserted in the wood. The screws were positioned perpendicular to the scanning

plane, following the reasoning of the pre-study. For those burnt samples where it was possible to remove the screw easily without disintegrating the sample, additional CT scans were conducted without the screw.

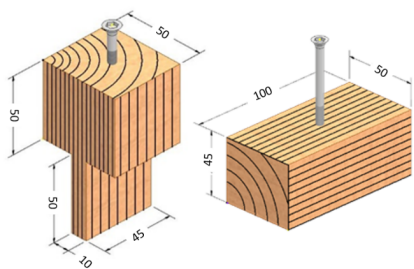

Figure 4: Sample dimensions for tension (left) and compression (right)

3.2 BURNING PROCESS

The samples were burnt in a cone calorimeter, according to the ISO 5660 standard [9]. The cone calorimeter is the most commonly used device to study small samples fire behaviour and is illustrated schematically in Figure 5. Samples are exposed to a one-dimensional radiative heat flux from a conical heater, with a constant surface heat flux of 35 kW/m² and a temperature of 722°C. These values have been chosen according to the fire exposition estimated in a real building fire.

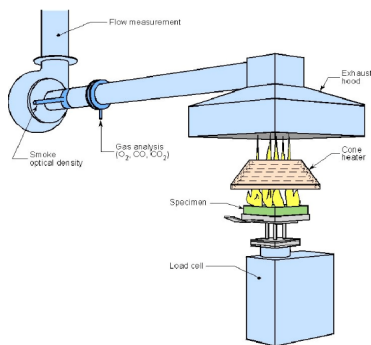

Figure 5: Cone calorimeter

To achieve a one-dimensional fire exposure, insulation layers of type Kaowool Blanket with a density of 64 kg/m³ were wrapped around the wooden samples and fixed with staples, leaving only one surface exposed to the heat.

3.3 MECHANICAL TESTS

The samples were tested with a universal testing machine (MTS Criterion Series 40) for both compression and tension. A loading speed of 0.2 mm/s and a maximum load limit of 10 kN were applied. The setup is shown in

Figure 6. For analysis, the mean values of respectively the tension and compression test series were used.

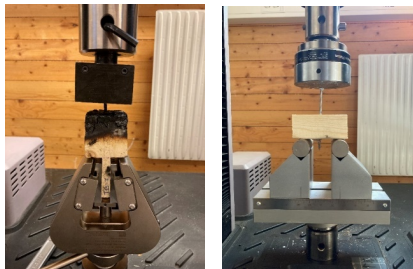

Figure 6: Mechanical test setup for tension (left) and compression (right)

4 IMAGE ANALYSIS

The CT images were analysed using Python code. Images of the same samples before and after the fire exposure were compared. The analyses were confined to 20 CT slices from the top of each sample, i.e. from the surface intended to be exposed to fire, which corresponded to 20 mm due to the 1 mm spacing between scans.

4.1 SINGLE IMAGE HISTOGRAMS

At first, the greyscale histograms of single image slices were analysed. Histograms from the same slice of a same sample before and after fire exposure were compared. For illustration, images of the same slice of a representative sample before and after a 10-minute heat exposure are shown in Figure 7.

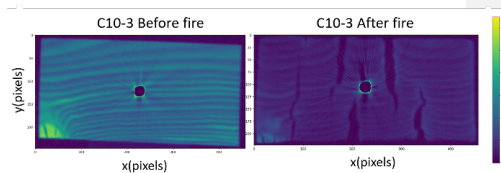

Figure 7: CT images of the same slice of the same sample before (left) and after (right) a 10-minute fire exposure

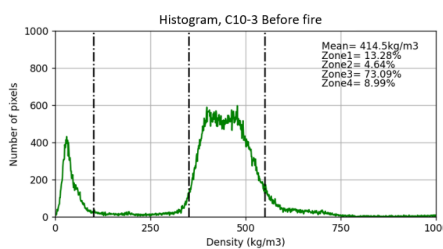

Figure 8: Histogram of the image before fire exposition

shows the histogram of the unburnt sample in Figure 7. The histogram was truncated at 1000 kg/m³ for a better readability, but there was also an additional peak at

Commenté [JH1]: Good! Please try to increase contrast (the right picture almost only looks black on my screen). You can do that by e.g. stopping at 3000 or lower in the color scale. Or maybe you find another way?

Commenté [QR2R1]: I removed pixel above 1300, this way the screw is not a problem anymore. I only did that for the "visualization", it was the easiest way to get a good contrast.

4000 kg/m³ caused by the metal of the screw. The histogram was separated into four distinct zones (vertical lines in the figure). We can distinguish two density peaks in

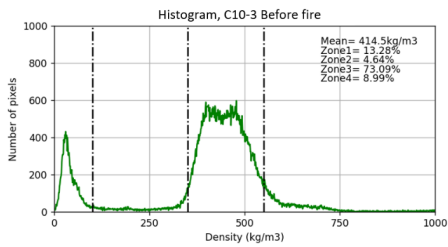

Figure 8: Histogram of the image before fire exposition

, which were characteristic for unburnt wood: the first in zone 1 around 50 kg/m³ representing air around the sample and covering approximately 13 % of the image, and the second in zone 3 between 400 and 550 kg/m³ representing wood and covering approximately 73 % of the image. The flat area in zone 2 represents approximately 5 % of the image.

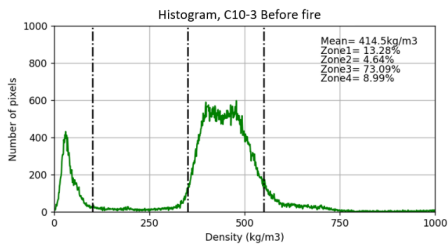

Figure 8: Histogram of the image before fire exposition

Figure 9 shows the histogram of the sample in Figure 7 that has been fire exposed for 10 minutes, again truncated for density. We are still able to distinguish two main peaks, however, they are now located in zone 1 (26 %) and zone 2 (73 %). The peak around 500 kg/m³ in

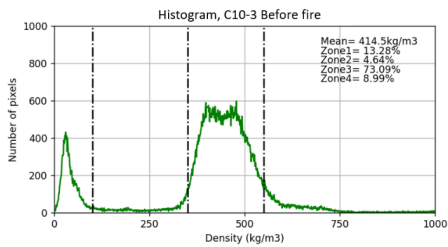

Figure 8: Histogram of the image before fire exposition

thus shifted to lower values due to the charring process and the resulting lower density of charcoal. The greyscale histogram can therefore be used to detect and quantify fire degradation.

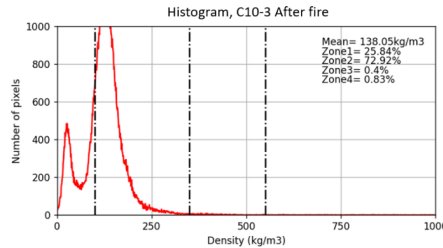

Figure 9: Histogram of the image after a 10-minute fire exposure

4.2 HISTOGRAM EVOLUTION THROUGH THE SAMPLE

The classification of the pixels according to the four density zones defined above can be used to study the evolution of the distribution in each class in consecutive slices along the CT scan of each sample.

Figure 10 shows this evolution for one representative sample before and after fire exposure along the top 20 mm from the surface exposed to fire. The figure clearly shows a shifting of the density from zone 3 (350-550 kg/m³) to zones 1 and 2 (0-350 kg/m³) when approaching the exposed surface. For the same sample before the fire exposition, we can notice that the zone classification remains constant when traversing the sample. Note also the rise of zone 1 (0-100 kg/m³) close to the top of the sample, which was due crack opening during the burning.

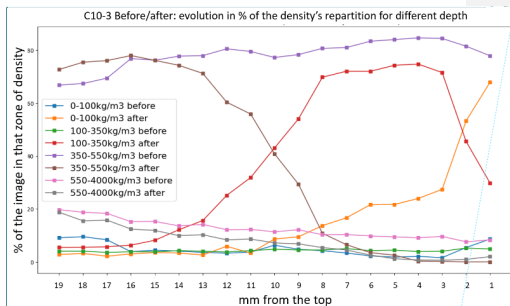

Figure 10: Evolution of density zones on the top 20 mm of the sample, before and after fire exposure

4.3 EVOLUTION OF DENSITY CLOSE TO THE SCREW

To study whether any particular degradation occurred due to increased heat conductivity of metal compared to wood, the following method was applied. For each CT slice, concentric circles with radii between 6-30 mm were created around the centre of the screw (Figure 11). Along the perimeter of each circle, the density was integrated, and average density was calculated.

Commenté [JH3]: Please:
 - increase font size in legend.
 - try to increase font size in axes labels (until it fills the available space)

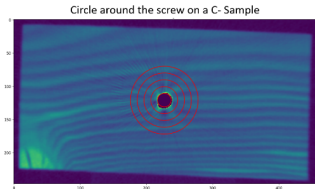

Figure 11: Concentric circles around the screw for studying wood degradation in the proximity of the screw.

The procedure was repeated for the CT slices representing the first 20 mm along the sample starting from the surface exposed to fire. The average density along each circle was then plotted for each slice to study its evolution at fixed distances from the centre of the screw.

In the subsequent figures, the density evolution profiles in the proximity of the screw are shown for representative compression and tension samples at 0, 5 and 10 minutes of fire exposure.

In **Figure 12**, we can see the mean density values on the circles before any fire degradation. The circle with the smallest radius is affected by the density of the screw and fluctuates due to noise from the metal. All the other values are approximately constant over the initial 20 mm from the top of the sample.

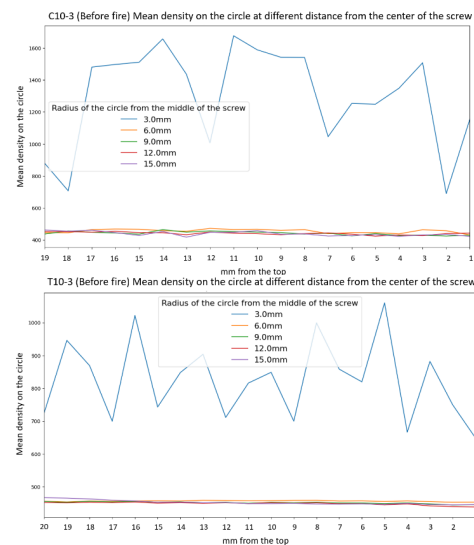

Figure 12: Graph of density measured on circles for samples without fire exposure

Figure 13 shows the evolution of the degradation around the screw on samples after a fire exposure of 5 minutes. The average density on all circles started to decrease approximately 7 mm from the top, which indicated the charring front, and it reached a lower constant value,

indicating burnt wood. Although the density on the innermost circle again fluctuated due to noise, it followed the same decreasing trend.

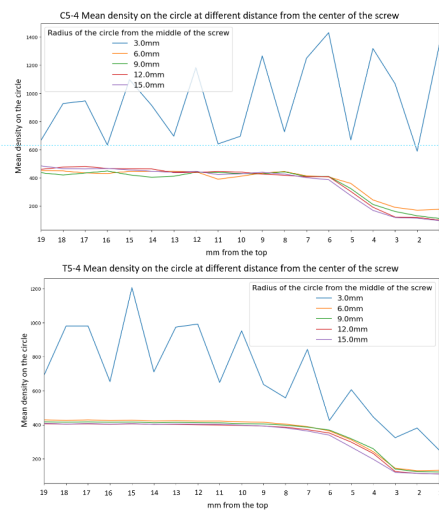

Figure 13: Graph of density measured on circles for samples after 5 minutes fire exposure

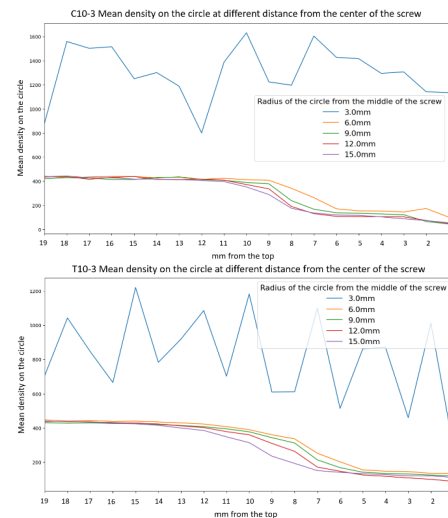

Figure 14: Graph of density measured on circles for samples after 10 minutes fire exposure

Figure 14 shows the evolution of the degradation around the screw on samples after a fire exposure of 10 minutes. Similarly to **Figure 13**, the density dropped to a lower constant value over a certain distance, but starting from a greater distance from the top of the samples due to increased charring.

Commenté [JH4]: Please:
- increase font sizes
- try to increase contrast

Commenté [JH5]: For Figures [C10-3], [T10-3], [C10-3] and [T10-3] Good, the numbering is now more logical. Please increase the font size in the legends!

In general, for all evolution graphs above, the mean density decreased for increasing circle radius, which was probably an effect of artefacts and noise around the screw which artificially increased the apparent density. With the screw still attached during the scans, we could therefore not observe a significant density loss close to the screw, which could have resulted from heat conduction

4.4 EVOLUTION OF DENSITY AFTER SCREW REMOVAL

The degradation of wood in the proximity of the screw was difficult to interpret in scans where the screws were present. The analysis procedure using concentric circles described above was thus repeated for CT scans of four fire-exposed samples in which the screws were carefully removed, instead of conducting destructive mechanical tests.

Figure 15 shows the evolution of the degradation around the screw hole on a representative sample after a fire exposure of 10 minutes and where the screw axis was perpendicular to the fibre direction. All curves follow the similar trend as with the screw inserted, and the noise affecting the innermost circle disappeared. Interestingly, the average density on the innermost circle was considerably higher than on circles further away from the hole. This higher density in the immediate proximity of the hole edge can be explained by compression of the wood during screw insertion, which can also be seen in the corresponding scan of the graph in Figure 16.

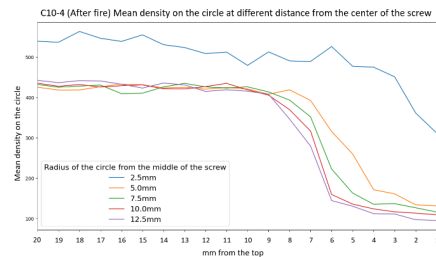

Figure 15: Graph of density measured on circles around the screw hole for samples after 10 minutes fire exposure and where the screw axis was perpendicular to the fibre direction

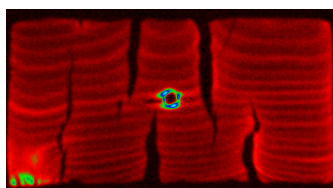

Figure 16: CT image of the sample used for calculating the graph in Figure 15, blue and green colour indicate elevated and red lower density values.

Figure 17 **Erreur ! Source du renvoi introuvable.** shows the evolution of the degradation around the screw hole on a representative sample after a fire exposure of 10 minutes

and where the screw axis was parallel to the fibre direction.

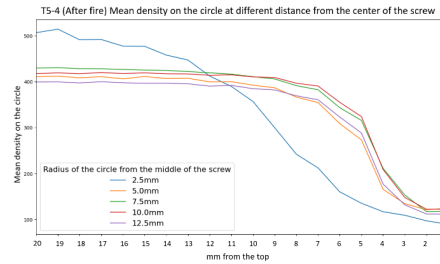

Figure 17: Graph of density measured on circles around the screw hole for samples after 10 minutes fire exposure and where the screw axis was parallel to the fibre direction

In contrast to the perpendicular case, the average density of the innermost circle clearly drops below the density of the areas further away from the hole when approaching the top (burnt) surface, which happens at around 10 mm from the top. This indicates that heat degradation in the screw hole has occurred. The lower density in the hole can also be observed in the corresponding scan in Figure 18.

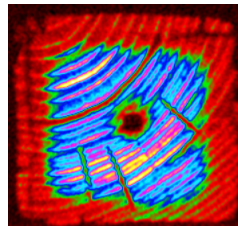

Figure 18: CT image of the sample used for calculating the graph in Figure 17, blue and green colour indicate elevated and red lower density values.

The observations indicate that the insertion direction of the screw with regards to the fibres could affect the fire resistance of the connection. When the screw is inserted, it densifies the wood around this as such should have a protective effect against charring in the hole. However, for the tests in this study, the charring progressed into the hole more easily if the screw was inserted parallel to the fibre directions. The effect could, however, also have been a result of the different sample geometries for the different insertion directions.

5 RESULTS OF MECHANICAL TESTS

Figure 19 shows box plots for the compression and tension tests on the samples. For both, loading parallel and perpendicular to the fibres, the load capacity reacts similarly to increasing length of fire exposure. There was almost no degradation of the load capacity during the five first minutes of fire exposure, but a noticeable degradation after 10 minutes exposure.

The degradation could be clearly linked to the observed charring depth in the image analysis of the CT images. The higher the indicated charring depth from the images, the lower the capacity of the connection.

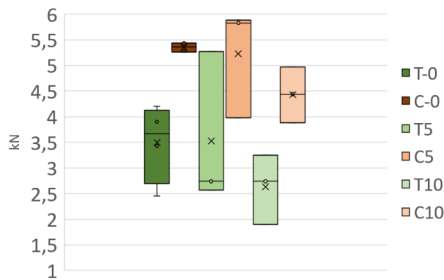

Figure 19: Load capacity box plots of the tested samples

Figure 20 shows the evolution of the load capacity of the connection as a function of the charring depth along the screw. Mean values were used for the figure. Compression and tension samples followed the same trend. Linear regression lines in the figure indicate a negative correlation between charring depth and load capacity.

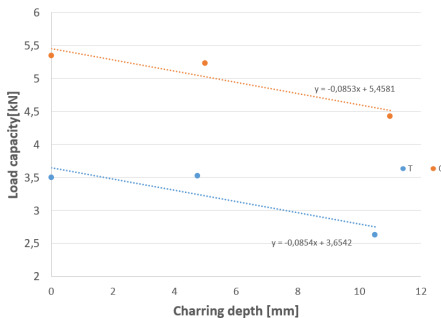

Figure 20: Evolution of load capacity as a function of the charring depth

6 CONCLUSIONS

This study has shown that it is possible to use CT images to observe fire degradation in wood with one fastener installed. It was concluded that

- the greyscale histogram of a CT image can be used to separate between wood, burnt wood and metal,
- the evolution of the histogram over increasing depth from a burnt surface can yield information about the charring depth,
- the evolution of the average density in the proximity of the screw hole can yield

information about the degradation of the connection, and

- it is difficult to fully avoid artefacts due to metal, but the effect can be mitigated by minimising the amount of metal in the scanning plane, or potentially by using higher energy X-rays.

We developed a first approach to investigate wood degradation close to the screw using the average density of concentric circles around the screw. Noise and artefacts generated by the screw make measurements close to the screw surface difficult in CT images, however, if the screw is removed, the edge of the hole can be investigated more easily. The results indicate that the charring behaviour in the proximity of the screw differs, depending on the insertion direction with respect to the fibres.

In the future, it could be interesting to focus analyses on the charring around the hole after removal of the screw to clarify whether the insertion direction indeed affects the charring.

REFERENCES

- [1] Laplanche K.: Etude du comportement au feu des assemblages de structures bois: approche expérimentale et modélisation. PhD Thesis, Université Blaise Pascal – Clermont-Ferrand, 2006.
- [2] European Committee for Standardization (CEN): EN 1995-1-2:2004, Eurocode 5: Design of Timber structures – Part 1-2: General - Structural fire design. 2009.
- [3] Palma P.: Fire behaviour of timber connections. PhD Thesis, ETH Zürich Research Collection, 2016.
- [4] Palma P., Frangi A., Hugi E., Cachim P., Cruz H.: Fire resistance tests on steel-to-timber dowelled connections reinforced with self-drilling screws. In: Proceedings of the 2nd Ibero-Latin-American Congress on Fire Safety, Coimbra, Portugal, 2013.
- [5] Palma P., Frangi A., Cachim P., Cruz H.: Fire resistance tests on beam-to-column shear connections. In: 8th International Conference on Structures in Fire, Shanghai, China, 2014.
- [6] Freyburger, C. et al.: Measuring wood density by means of X-ray computer tomography. Ann. For. Sci. 66, 804, 2009.
- [7] Hansson L., Couceiro J. and Fjellner B.A.: Estimation of shrinkage coefficients in radial and tangential directions from CT-images. Wood Mater. Sci. Eng. 12(4):251-256, 2016.
- [8] Huber J. A. J. et al.: A method for generating finite element models of wood boards from X-ray computed tomography scans. Comput. Struct., 260:106702, 2022.
- [9] Swedish Standards Institute: SS-ISO 5660-1:2019, Reaction-to-fire tests – Heat release, smoke production and mass loss rate – Part 1: Heat release rate (cone calorimeter method) and smoke production rate (dynamic measurement). 2019.

Commenté [JH6]: Good! Please:

- remove the title in the plot
- increase the font of the axis and the legend
- rename T and C to T-0 and C-0

Commenté [JH7]: Please:

- Remove the chart title
- Increase font size of the axes, the legend and the linear laws
- if you can: rename Linéaire to "regression" or remove the legend entry