



HAL
open science

Influence of Shielding on the Magnetic Field Emitted by the LED Driver

Abdelhakim Zeghoudi, Abdelber Bendaoud, A. Benazza, Seyf Eddine Bechekir, Laurent Canale

► To cite this version:

Abdelhakim Zeghoudi, Abdelber Bendaoud, A. Benazza, Seyf Eddine Bechekir, Laurent Canale. Influence of Shielding on the Magnetic Field Emitted by the LED Driver. The 1st national conference on emergent technologies in electrical engineering (NCETEE'23), Oct 2023, Sétif, Algeria. hal-04356794

HAL Id: hal-04356794

<https://hal.science/hal-04356794>

Submitted on 27 Dec 2023

HAL is a multi-disciplinary open access archive for the deposit and dissemination of scientific research documents, whether they are published or not. The documents may come from teaching and research institutions in France or abroad, or from public or private research centers.

L'archive ouverte pluridisciplinaire **HAL**, est destinée au dépôt et à la diffusion de documents scientifiques de niveau recherche, publiés ou non, émanant des établissements d'enseignement et de recherche français ou étrangers, des laboratoires publics ou privés.

Copyright

Influence of Shielding on the Magnetic Field Emitted by the LED Driver.

Abdelhakim ZEGHOUDI¹, Abdelber BENDAOU¹, Baghdadi BENZAZZA¹,
Seyf Eddine BECHEKIR¹, Laurent CANALE²

¹APELEC Laboratory, Department of Electrical Engineering, Djilali Liabes University, Sidi Bel Abbes, Algeria
Hakooomezghoudi@gmail.com

²LAPLACE Laboratory, University of Toulouse, CNRS, INPT, UPS, Toulouse, France

Abstract — LED lamps are an extremely efficient, economical and durable lighting option that has revolutionized the lighting industry. They are increasingly used in many areas due to their significant advantages in energy efficiency and sustainability. To operate the LED lamps, you only need an AC/DC driver.

The aim of this study is to quantify the magnetic near field above LED driver, for the three components (H_x , H_y , H_z), in the frequency domain were performed by using spectrum analyzer. Then, the magnetic field with shielding was determined. The magnetic shielding techniques used are total shielding, partial shielding or double total shielding. All the cases are compared with each other in all directions x , y and z . The shielding material that we used is Aluminum foil of about 0.1 mm thickness, the LED driver size which is equal to $(x, y) = (2.8 \text{ cm}, 1.6 \text{ cm})$ supplied by an AC 220 V source, 50 Hz of frequency.

Index Terms — LED driver, Near Magnetic Field, Magnetic probe, Magnetic Shielding, Frequency domain (FD).

I. INTRODUCTION

A LED driver is an essential component in LED lighting systems, ensuring that LEDs operate efficiently, reliably and long-lasting. It provides the right amount of current and voltage to optimize LED performance, while providing features such as protection and regulation [1-4]. However, LED drivers are sources of conducted and radiated electromagnetic disturbances due to high-frequency switching electronic switches such as MOSFET, IGBT, as well as rectifier diodes that generate low-frequency current harmonics, passive components (capacitors, inductors), and parasitic elements [5-11].

Electromagnetic radiation can be measured in the far field or in the near field (NF). However, near-field measurement has attractive advantages in terms of cost, accuracy, and scope. In addition, the NF scanning technique is less dependent on test conditions. Thus, it has been used to obtain EM fields, provide EMC studies and source diagnostics [12-18].

For this case, the protection materials against radiated electromagnetic in sensitive electrical and electronic devices to avoid disturbances of the external and internal electromagnetic field between the system components itself is very interesting [19-21].

Electromagnetic shielding is one of the possible solutions, usually metal housing is used. Unfortunately, the housing is equipped with openings and slots that lead to a degradation of the shielding performance [21-25].

Magnetic shielding works on the principle of deflection of magnetic field lines. When the shielding material is placed between the source of the magnetic field and the object or device to be protected, it attracts the magnetic field lines, creating a path of least resistance. This has the effect of reducing the magnetic field within the protected area [26].

This work is structured as follows: Section II introduces the AC/DC LED drive converter under examination, providing a comprehensive overview of its characteristics. Section III elaborates on the near-field scanning method in the FD, including a description of the magnetic field probes utilized in the bench measurement. Finally, Section IV outlines and analyzes the experimental findings pertaining to the near magnetic field, both with and without shielding positioned above the driver. The conclusion is presented in section V.

II. AC/DC LED Driver Study

The focus of this paper is on the analysis of an AC/DC converter LED driver that powers a 12 W lamp. The driver operates with a supply voltage of 220 V at a frequency of 50 Hz. It comprises a MB10F bridge rectifier, along with passive elements such as capacitors, inductors, resistors, and an ES1J diode Figure 1 illustrates the placement of its components on the printed circuit board (PCB).

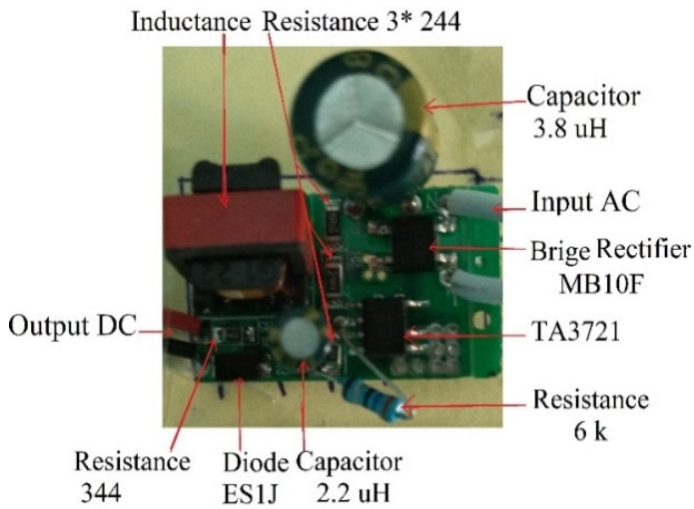

Fig. 1. LED driver modules integrated onto the PCB.

III. Magnetic Field Measurement Bench

In this study, the radiation measurement of the studied AC/DC converter of the LED driver is carried out in measurement for different magnetic probes of type Rohde Schwarz Probe (1), RSH400-1, Probe (2), RSH50-1 and Probe (3), RSH 2.5-2 [27] as shown in Figure 2.



Fig. 2. Rohde Schwarz type magnetic probes.

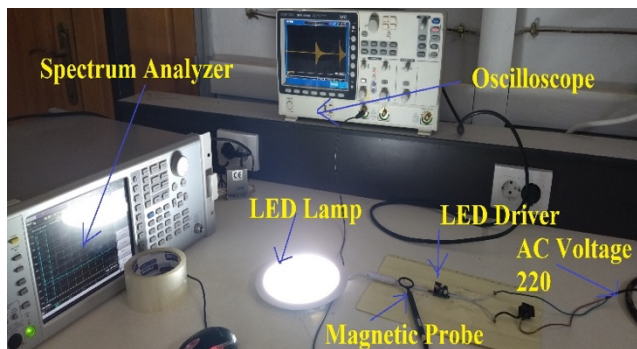

Fig. 3. Bench measuring the near magnetic field with and without shielding above the driver.

The frequency measurement technique employs a high-precision spectrum analyzer with a wide bandwidth. This equipment is utilized for visualizing and recording the frequency signals acquired through the magnetic field probe's measurement above the LED driver, as illustrated in Figure 3.

In Figure 4, we observe the probe being systematically scanned over the LED Driver using a tracing table. This manual process involves moving the probe across the circuit under test to gather magnetic field measurements at precise points on the surface designated for mapping, with a step size of 0.5 cm.

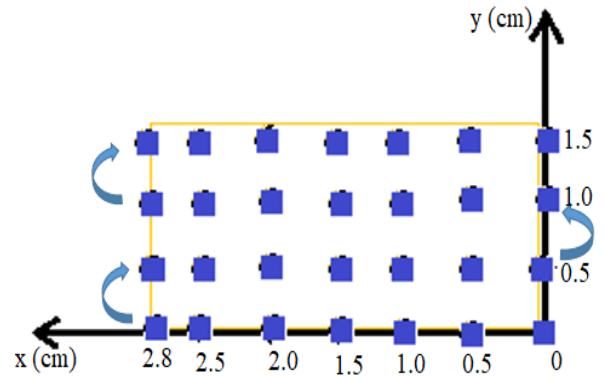

Fig. 4. Principle of Scanning over the LED Driver.

IV. Results and Discussions

❖ current shape and Total Harmonic Distortion (THD)

Figure 5 shows the current and voltage at the input of the LED Driver. We notice a sinusoidal voltage signal against the periodic current signal period strictly identical to the initial sinusoid but very different form because of the presence of the non-linear load which is a rectifier with diode bridge (MB10F), so it's a source of pollution for the line current.

Figure 6 shows the odd harmonics of the line current at the base frequency. We notice a very important amplitude of harmonic current of order 3 compared to the fundamental current, also the odd harmonics of order 5, 7, 9, etc..., this phenomenon can explain by the presence of a source of harmonics, and therefore a poor power factor and a very high total harmonic distortion (THD).

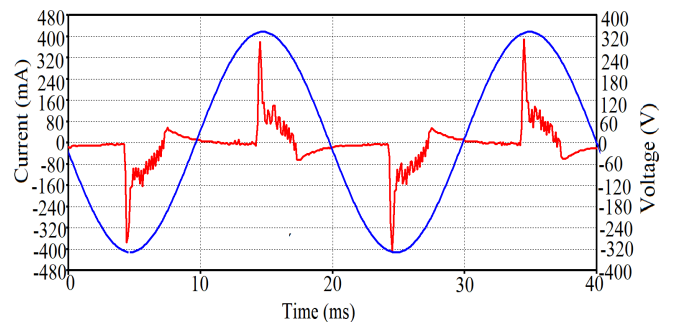

Fig. 5. Input current and voltage for LED Driver.

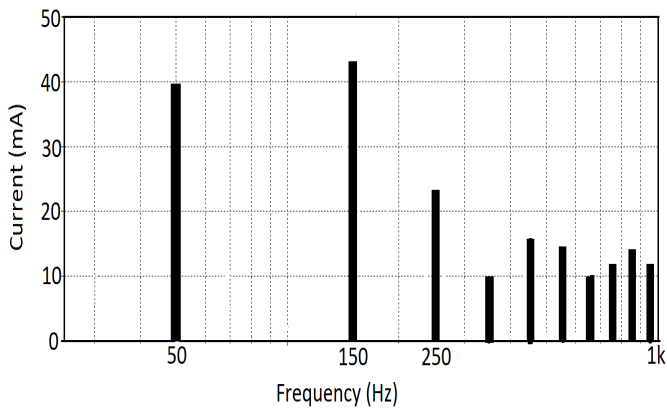

Fig. 6. Frequency spectrum of harmonics generated by the AC/DC LED Driver.

Figure 7 illustrates the dimensions of the examined circuit, with lengths denoted as $x = 2.8$ cm and $y = 1.6$ cm, and the maximum component height designated as $z = 1.4$ cm. Magnetic field measurements were conducted in three directions (x, y, z) at $z = 1.5$ cm, with and without shielding. The magnetic field probe employed was the RSH 50-1 probe (2)

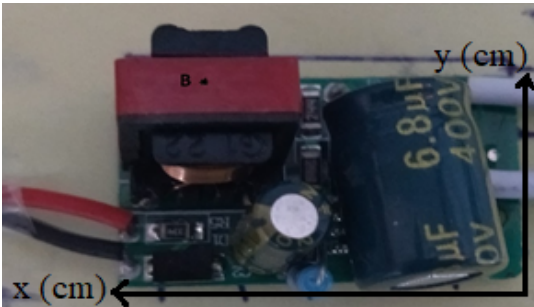

Fig. 7. Dimension of the LED driver.

❖ Magnetic Shielding

In order to measure the near magnetic field above the LED driver, it is necessary to look for some technique to reduce the radiated emissions. Among the techniques of the electromagnetic shielding, we used in our study the Aluminum foil as a shield against the magnetic field generated by the LED driver. We made a total circuit shielding and a partial shielding just on the inductor because this last one is generating much more radiated emissions compared to the other electronic components, as shown in the figure 8. The thickness of shielding is equal to 0.1 mm.

Figure 10 shows the magnetic field close to the H_x component for the three cases: without shielding, with total or partial shielding using the probe (2) RSH 50-1 above the driver in the center of the inductor at " z " = 1.5 cm. We note that the magnetic field decreases with the shielding, so the intensity of the field is less in the case of the total shielding compared to the partial shielding although we measured the field above the inductance which can explain that the magnetic field above the LED is not only generated by the inductor, but also by the neighboring circuit.

Figure 11 shows the near magnetic field of the H_y component above the LED driver at the center of the inductor. We notice the radiated emissions with the reduced shielding, so, the magnetic field almost identical for total and partial shielding. For the magnetic field of the component H_z above the LED driver in the center of inductor, we find more intense magnetic field in the case of shielding, then a reduction towards the high frequencies as shown in the Figure 12.

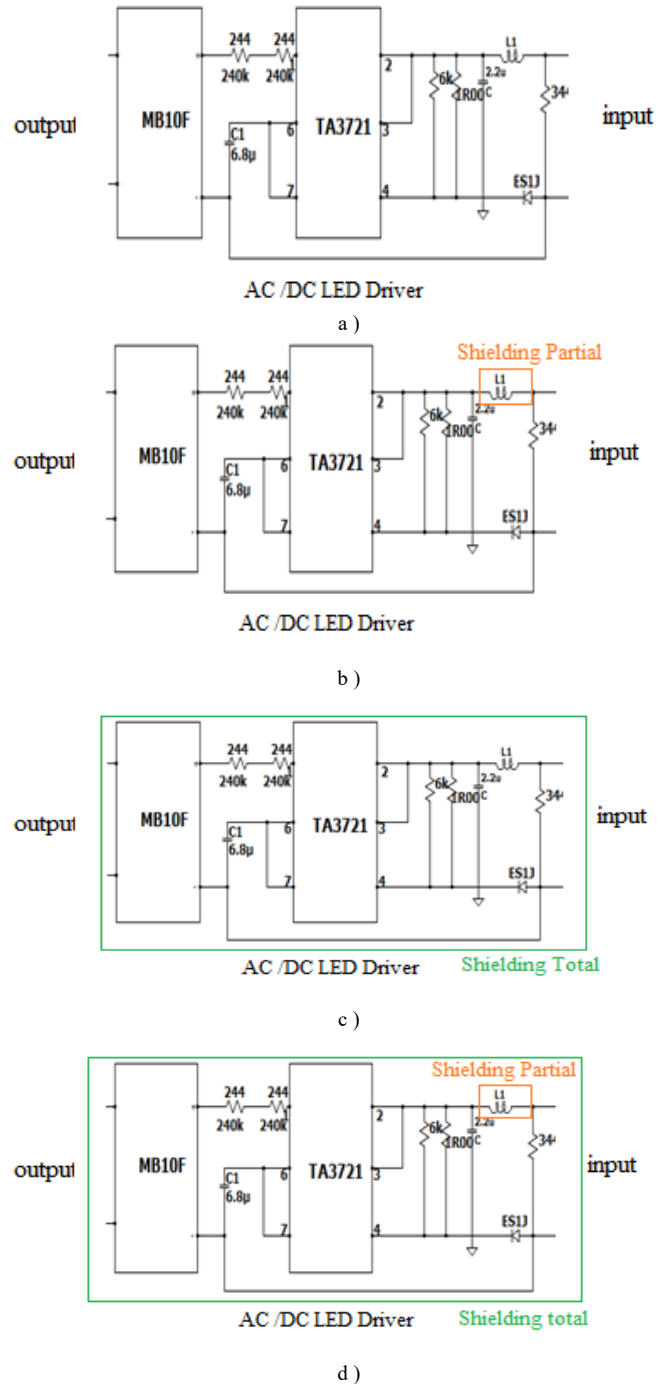

Fig. 8. LED driver and type of Shielding a) without Shielding, b) Partial shielding, c) Total shielding, d) Double shielding.

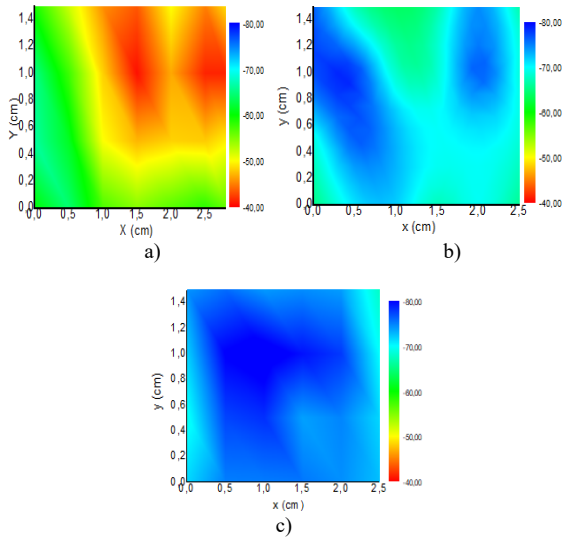

Fig. 9. Magnetic field scan component H_z above the LED driver at $z = 1.5$ cm: (a) without shielding, (b) partial shielding (c) total shielding.

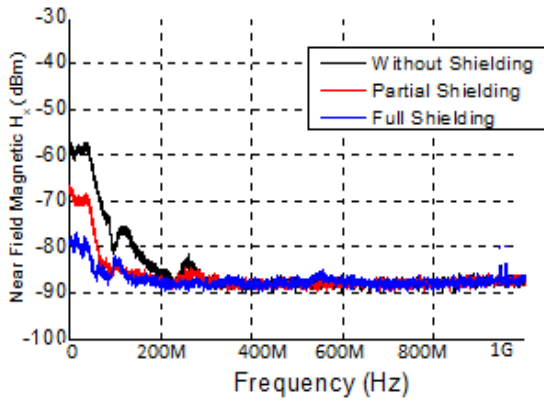

Fig. 10. Near magnetic field of component H_x with and without shielding.

Therefore, with the partial shielding the near magnetic field is reduced, and for the total shielding the radiated emissions reduced again more than the partial shielding, beyond the frequency 200 MHz we observe an identical between the two curves of shielding.

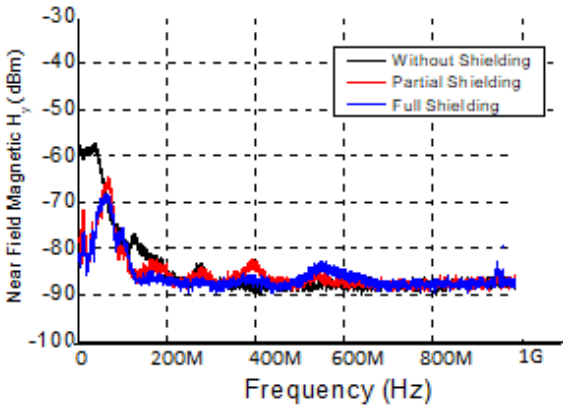

Fig. 11. Near magnetic field of component H_y with and without shielding

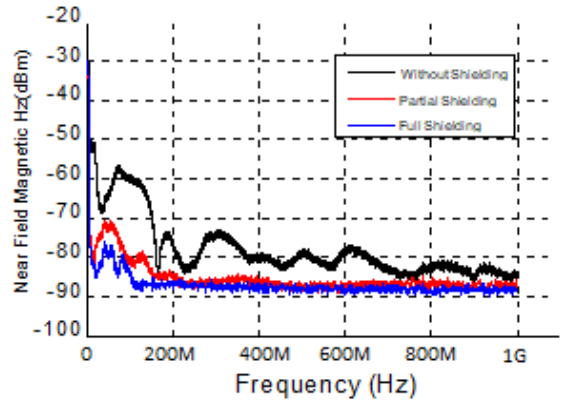

Fig. 12. Near magnetic field of component H_z with and without shielding.

Figure 13 shows the magnetic field of the component H_z above the LED driver using the probe (1) which has a surface diameter of about 25 mm. We measured the magnetic field in the center of the circuit which is $(x, y) = (1.4$ cm, 0.8 cm) at the height $z = 1.5$ cm. For total or partial shielding or double shielding, we notice that the radiated emissions in the case of double shielding is very low because of the increase of aluminum thickness, with a minimization towards high frequencies, the case of partial shielding of the inductor, the reduced magnetic field and the margin between the case without shielding and partial shielding defines the magnetic field effect by the inductor, and the margin between the case without shielding and total shielding presents the magnetic field effect by the driver circuit.

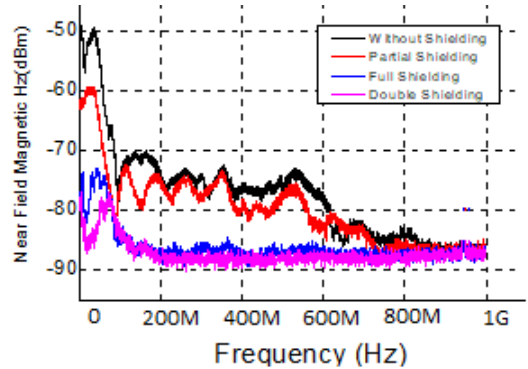

Fig. 13. Near magnetic field with and without Shielding at the center of LED Driver at $z = 1.5$ cm, measured with the probe RSH400-1.

V. Conclusion

This paper presented the more preferable near-field scanning method to quantify the radiated EMI noise of magnetic near-field for a printed circuit board (PCB) with the electronic components based on AC/DC LED driver in frequency domain in three directions. The near magnetic field generated by the inductor exceeds the limit of EMI standards CISPR 11 class A. In this case, the magnetic shielding is one of the most known solutions to reduce the radiated emissions emitted by the inductor that we used. The near magnetic field scan with partial shielding of the inductor or the total shielding of the whole driver circuit have been studied after a scan, where we observe the reduction of the radiated disturbances

above the LED driver. Then the effect of different shielding techniques above the center of the inductor have been presented and compared with each other, for the different magnetic probe.

REFERENCES

- [1] A. Zeghoudi, A. Bendaoud, H. Slimani, M. Miloudi, H. Miloudi, L. Canale, A. Tilmatine and H. Slimani, "Experimental Measurement of Near Magnetic Field by Different Probe for AC/DC LED Driver," 2022 IEEE International Conference on Environment and Electrical Engineering and 2022 IEEE Industrial and Commercial Power Systems Europe (EEEIC / I&CPS Europe), 2022, pp. 1-6, doi: 10.1109/EEEIC/ICPSEurope54979.2022.9854788
- [2] A. Zeghoudi, A. Bendaoud, L. Canale, A. Tilmatine and H. Slimani, "Common Mode and Differential Mode noise of AC/DC LED Driver," 2021 IEEE International Conference on Environment and Electrical Engineering and 2021 IEEE Industrial and Commercial Power Systems Europe (EEEIC / I&CPS Europe), 2021, pp. 1-6, doi: 10.1109/EEEIC/ICPSEurope51590.2021.9584616.
- [3] B. Lehman and A. Shteynberg, "Professional Education Seminars: LED lighting: trends, standards, optics and power electronics," presented at Applied Power Electronics Conference and Exposition (APEC), Fort Worth, 2011.
- [4] R. Simanjuntak, P. Dupuis, L. Canale, N. I. Sinisuka and G. Zissis, "Power quality of energy saving lamps under wide voltage variations," 2014 IEEE Industry Application Society Annual Meeting, 2014, pp. 1-7, doi: 10.1109/IAS.2014.6978427.
- [5] A. Zeghoudi, A. Bendaoud, L. Canale, A. Tilmatine and H. Slimani, "Determination of Power Factor and Harmonic Distortion of AC/DC LED Driver," 2021 IEEE International Conference on Environment and Electrical Engineering and 2021 IEEE Industrial and Commercial Power Systems Europe (EEEIC / I&CPS Europe), 2021, pp. 1-6, doi: 10.1109/EEEIC/ICPSEurope51590.2021.9584665.
- [6] A. Zeghoudi, A. Bendaoud, H. Slimani, B. Benazza, H. Miloudi, L. Canale, "Power Impact And Electromagnetic Disturbances Of Different Lighting Modes From Spot LED Lamp", *Optik International Journal Of Light And Electron Optics*, DOI:10.1016/j.ijleo.2022.169898
- [7] A. Zeghoudi, A. Bendaoud, H. Slimani, B. Benazza, and Bennouna 2022 Determination of electromagnetic disturbances in a buck chopper, *Australian Journal of Electrical and Electronics Engineering*, DOI: 10.1080/1448837X.2021.2023073.
- [8] Slimani, H., Zeghoudi, A., Bendaoud, A., & Bechekir, S. (2023). Experimental evaluation of conducted disturbances induced during high frequency switching of active components. *Electrical Engineering & Electromechanics*, (5), 26–30. <https://doi.org/10.20998/2074-272X.2023.5.04>
- [9] Juntao Yao, Shuo Wang, Zheng Lu, "Modeling, Analysis, and Reduction of Radiated EMI Due to the Voltage across Input and Output Cables in an Automotive Non-isolated Power Converter", *IEEE Transactions on Power Electronics*, Vol. 37, no.5, pp.5455- 5465, May 2022.
- [10] Bednarek Karol, Typanska Dorota, Misiorny Jakub, Pietkiewicz Arkadiusz, "Reduction of electromagnetic disturbances emission generated by LED lighting fixture ", *Applications of Electromagnetics in Modern Techniques and Medicine (PTZE)*, Poland, sept 2018.
- [11] Kai Ishida, Keita Suzuki, Eisuke Hanada, Minoru Hirose, "EMC of Wireless Medical Telemeters and Noise Radiated from Light Emitting Diode Lamps", *The 2017 International Symposium on Electromagnetic Compatibility - EMC EUROPE 2017*, Angers, France, September 4-8, 2017.
- [12] A. Zeghoudi, A. Bendaoud, A. Tilmatine, S. Bechekir, G. Zissis, L. Canale, "Study of the impact of the power dimming and lighting modes of LED lamps on the near magnetic field," *Optik*, Volume 271, 2022, 169997, ISSN 0030-4026, <https://doi.org/10.1016/j.ijleo.2022.169997>.
- [13] A. Zeghoudi, A. Bendaoud, H. Slimani, M. Miloudi, H. Miloudi, L. Canale, A. Tilmatine and H. Slimani, "Experimental Measurement of Near Magnetic Field by Different Probe for AC/DC LED Driver," 2022 IEEE International Conference on Environment and Electrical Engineering and 2022 IEEE Industrial and Commercial Power Systems Europe (EEEIC / I&CPS Europe), 2022, pp. 1-6, doi: 10.1109/EEEIC/ICPSEurope54979.2022.9854788
- [14] A. Frikha, M. Bensetti, F. Duval, F. Lafon, and L. Pichon, "Modeling of the shielding effectiveness of enclosures in near field at low frequencies," in *Proc. Int. Conf. Electromagn. Adv. Appl.*, Torino, Italy, Sept. 2013, pp. 612–615.
- [15] Fethi Benyoubi, Lionel Pichon, Mohamed Bensetti, Yann Le Bihan, and Mouloud Feliachi, "An Efficient Method for Modeling the Magnetic Field Emissions of Power Electronic Equipment from Magnetic Near Field Measurements," *IEEE Transactions on Electromagnetic Compatibility*, 2017, 59 (2), pp.609-617, April, 2017.
- [16] Z. Song, S. Donglin, F. Duval, A. Louis, and D. Fei, "A novel electromagnetic radiated emission source identification methodology," in *Proc. Asia-Pacific Symp. Electromagn. Compat.*, Peking, China, Apr. 2010, pp. 645–648.
- [17] B. Essakhi, D. Baudry, O. Maurice, A. Louis, L. Pichon, and B. Mazari, "Characterization of radiated emissions from power electronic devices: Synthesis of an equivalent model from near-field measurement," *Eur. Phys. J. Appl. Phys.*, vol. 38, pp. 275–281, 2007.
- [18] S.Saidi and J. Ben Hadj Slama, "A near-field technique based on PZMI, GA, and ANN: Application to power electronics systems," *IEEE Trans. Electromagn., Compat.*, vol. 56, no. 4, pp. 784–791, Aug. 2014.
- [19] A.Frikha, M. Bensetti, F. Duval, F. Lafon, and L. Pichon, "Prediction of the shielding effectiveness at low frequency in near magnetic field," *Eur. Phys. J. Appl. Phys.* vol. 66, Art. no. 10904, 2014,
- [20] Frikha, M. Bensetti, F. Duval, N. Benjelloun, F. Lafon, and L. Pichon, "A new methodology to predict the magnetic shielding effectiveness of enclosures at low frequency in the near field," *IEEE Trans.Magn.*, vol. 51, no. 3, pp. 1–4, Mar. 2015.
- [21] H. W. Ott, *Electromagnetic compatibility engineering*. A John Wiley & Sons, Inc, Wiley-Interscience, USA, 2009.
- [22] C. R. Paul, *Introduction to Electromagnetic Compatibility*. A John Wiley & Sons, Inc, Wiley-Interscience, New York, 2006.
- [23] F. Rachidi, "Blindage," *Notes de cours, Compatibilités électromagnétique*, École Polytechnique Fédérale de Lausanne, 2005
- [24] Sassa Hedia, Bessem Zitouna, Jaleddine Ben Hadj Slama, and Lionel Pichon, "Electromagnetic Time Reversal in the Near Field: Characterization of Transient Disturbances in Power Electronics," *IEEE Transactions on Electromagnetic Compatibility*, February 2020.
- [25] A. Zeghoudi, L. Canale, A. Bendaoud, A. Tilmatine and G. Zissis, "Experimental Measurements of Shielding Influences on Near Magnetic Field for LED Lighting Sources," 2023 IEEE International Conference on Environment and Electrical Engineering and 2023 IEEE Industrial and Commercial Power Systems Europe (EEEIC / I&CPS Europe), Madrid, Spain, 2023, pp. 1-6, doi: 10.1109/EEEIC/ICPSEurope57605.2023.10194716.
- [26] A. Zeghoudi, A. Bendaoud, H. Miloudi, S. Bechekir, H. Slimani and M. Miloudi, "Effectiveness of Shielding on the Magnetic Emissions Emitted by a Toroidal Inductor," 2022 2nd International Conference on Advanced Electrical Engineering (ICAEE), Constantine, Algeria, 2022, pp. 1-7, doi: 10.1109/ICAEE53772.2022.9962063
- [27] R&S®HZ-15/R&S®HZ-17Probe Sets R&S®HZ-16 Preamplifier "E and H near-field emission measurements with test receivers, spectrum analyzers and oscilloscopes" Product Brochure version 01.00