



HAL
open science

Stereovision Algorithm to be Executed at 100Hz on a FPGA-Based Architecture

Michel Devy, Jean-Louis Boizard, Diego Botero, Henry Carrillo, Mario Ibarra,
Zohir Irki, Abdelelah Naoulou, Pierre Lacroix, Philippe Fillatreau, Jean-Yves
Fourniols, et al.

► **To cite this version:**

Michel Devy, Jean-Louis Boizard, Diego Botero, Henry Carrillo, Mario Ibarra, et al.. Stereovision Algorithm to be Executed at 100Hz on a FPGA-Based Architecture. *Advances in Theory and Applications of Stereo Vision, InTech*, pp.327-352, 2011, 978-953-307-516-7. <10.5772/14037>. <hal-04353104>

HAL Id: hal-04353104

<https://hal.science/hal-04353104v1>

Submitted on 19 Dec 2023

HAL is a multi-disciplinary open access archive for the deposit and dissemination of scientific research documents, whether they are published or not. The documents may come from teaching and research institutions in France or abroad, or from public or private research centers.

L'archive ouverte pluridisciplinaire **HAL**, est destinée au dépôt et à la diffusion de documents scientifiques de niveau recherche, publiés ou non, émanant des établissements d'enseignement et de recherche français ou étrangers, des laboratoires publics ou privés.



HAL Authorization



Open Archive Toulouse Archive Ouverte (OATAO)

OATAO is an open access repository that collects the work of Toulouse researchers and makes it freely available over the web where possible.

This is an author-deposited version published in: <http://oatao.univ-toulouse.fr/>
Eprints ID: 12030

Identification number: DOI : 10.5772/14037
Official URL: <http://dx.doi.org/10.5772/14037>

To cite this version:

Devy, Michel and Boizard, Jean-Louis and Botero Galeano, Diego and Carrillo Lindado, Henry and Ibarra Manzano, Mario and Irki, Zohir and Naoulou, Abdelelah and Lacroix, Pierre and Fillatreau, Philippe and Fourniols, Jean-Yves and Parra, Carlos *Chapter 17. Stereovision Algorithm to be Executed at 100Hz on a FPGA-Based Architecture.* (2011) In: *Advances in Theory and Applications of Stereo Vision.* InTech, pp. 327-352. ISBN 978-953-307-516-7

Any correspondence concerning this service should be sent to the repository administrator:
staff-oatao@inp-toulouse.fr

Stereovision Algorithm to be Executed at 100Hz on a FPGA-Based Architecture

Michel Devy¹ *; Jean-Louis Boizard², Diego Botero Galeano³, Henry Carrillo Lindado⁴, Mario Ibarra Manzano⁵, Zohir Irki⁶, Abdelelah Naoulou⁷, Pierre Lacroix⁸, Philippe Fillatreau⁹, Jean-Yves Fourniols¹⁰, Carlos Parra¹¹
^{1,2,3,5,6,7,8,10} CNRS; LAAS; 7 avenue du Colonel Roche, F-31077 Toulouse
 Université de Toulouse; UPS, INSA, INP, ISAE; LAAS-CNRS : F-31077 Toulouse
^{3,4,11} Pontificia Universidad Javeriana; Carrera 7 No. 40-62; Bogotá
⁹ Delta Technologies Sud Ouest; 2 Impasse Michel Labrousse, 31036 Toulouse
^{1,2,3,5,6,7,8,9,10} France
^{3,4,11} Columbia

1. Introduction

This chapter describes the development of an integrated stereovision sensor intended to be embedded on mobile platforms like robots or intelligent vehicles. Such a sensor is required for the motion control of these platforms. Navigation can be either autonomous (e.g. for a robot executing tasks in dangerous environments), or supervised by a human driver (typically for intelligent transportation systems).

Motion control of a mobile vehicle requires to integrate on the platform, a system generally structured in several levels. At the lower level, functions are encapsulated in modules directly connected to sensors and actuators; the next level, named generally the supervision level, controls the execution of these functions, recovers from internal errors or from unexpected events in the environment; finally the upper level, or decision-making level, generates tasks or adapts existing scripts with respect to missions which are generally transmitted by an operator through a communication medium. Tasks and scripts activate sequentially or in parallel several functions at the lower level. Depending on the complexity of the platform (number of sensors and actuators), of the environment (static vs dynamic, structured vs unstructured, a priori known vs unknown...) and of the missions to be executed, the system embedded on a mobile platform, is implemented on one or several processors, and could take advantage of dedicated subsystems, e.g. smart sensors equipped by its own processing unit, or smart actuators fitted with micro-controllers.

Our project deals with the design and the implementation of a smart sensor that could execute complex perceptual functions, while satisfying very demanding real-time constraints. As soon as a motion must be executed by a mobile platform, perception functions provide environment modelling and monitoring, human-machine interface, sensor-based servoing, obstacle detection ... Real time execution is required when tasks are executed in dynamic

* Authors contact: michel.devy@laas.fr.

environments, i.e. when several mobile platforms act in the same area (multi-robots applications or several vehicles on roads) or when these platforms act in human environments (pedestrians in urban scenes, human operators for service robots...). Real time constraints depend on the relative speeds between mobile entities: for example, obstacle detection on an intelligent transportation system, must be executed at 100Hz, so that (1) several detections could be fused before activating an avoidance or an alarm action and (2) Time To Collision remains compatible with the system or the driver reaction time.

Sensory data must be acquired on the environment, in order to feed perceptual functions devoted to detection, tracking, identification or interpretation of events, environment modelling, visual odometry or self-localization ... Vehicles or robots are equipped with cameras, telemeters (radar, laser, sonar...) or with more specific devices (RFID readers, magnetic sensors...). Vision is the more popular, not only for biologically or human inspired apriorism, but because it has many advantages: high resolution, cheap sensors, acquisition of both photometric and geometric information ... Nevertheless, vision (especially 3D vision) is known to be very computationally demanding: it is why adapted visual algorithms and dedicated hardware subsystems must be jointly designed and evaluated for these applications.

In the section 2, some works related to obstacle detection are recalled, as a justification for our hardware implementation of the stereovision algorithm. Then the classical stereovision algorithm is described in section 3, before presenting the state of the art for real time stereovision systems in section 4. The FPGA-based architecture for our hardware stereovision implementation is described in section 5. Our real time stereovision system is presented in section 6 and is evaluated in section 7. Finally, conclusions and perspectives are discussed in section 8.

2. Stereovision for ITS applications

Companies which make Intelligent Transportation Systems (ITS), are eager to integrate sensors and perceptual algorithms on cars, for different applications: obstacle detection on motorway or in urban traffic, lane departure detection, parking assistance, navigation, cockpit and driver monitoring... Different sensors have been evaluated for these applications: only vision is considered in this paper.

- monocular vision has been proposed to detect obstacles (cars or pedestrians) in urban scenes, but without assumptions on the environment (no "flat road" approximation for example). Monocular vision does not allow to cope with complex situations and is generally coupled with other kind of sensors (e.g. radar or laser devices).
- stereovision is widely used in the robotics community, typically to evaluate the terrain navigability at short distances (Matthies (1992)). Several companies (*Videre Design Company* (n.d.)) propose stereo rigs with a short baseline (10cm), well suited for indoor perception; K.Konolige (Konolige (1997)) has developed the SVS library, with a real-time version of the stereo correlation algorithm (30Hz); VIDERE has also implemented this algorithm on a FPGA-based architecture.
- stereovision has been also evaluated in ITS applications for many years, but the real-time requirements, the limitations of the depth field, the lack of robustness... makes difficult to use stereovision in changing contexts.

In the LAAS robotics team, stereo is the main sensor used for outdoor terrestrial robot (figure 1 (top left)). It has been evaluated for several ITS applications:



Fig. 1. Example of stereo setups, on a robot (top left) or inside a vehicle for cockpit monitoring (top right) or road perception (bottom)

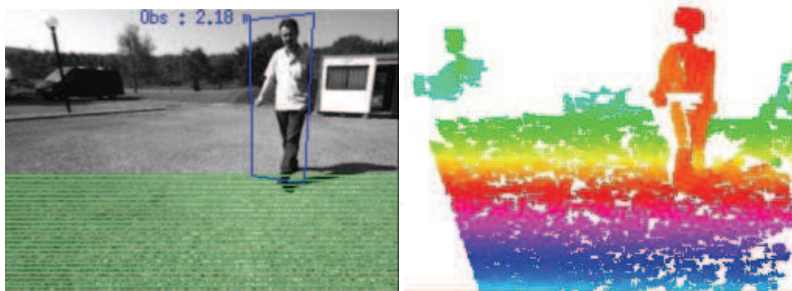

Fig. 2. Obstacle detection in a urban scene

- monitoring of the passenger seat (Devy et al. (2000)) with Siemens VDO. Figure 1 (top right) shows the sensor integrated in an experimental car ¹;
- detection of a free parking slot and assistance for the parking manoeuvre (Lemonde et al. (2005)). Figure 3 shows the rectified image built from the left camera of the stereovision sensor (left) and the disparity image (right);
- pedestrian detection in urban scene (see figure 2, where it can be seen dense disparity information on the ground) or obstacle detection on motorway (Lemonde et al. (2004))

¹ Test vehicle of Continental in Toulouse, France

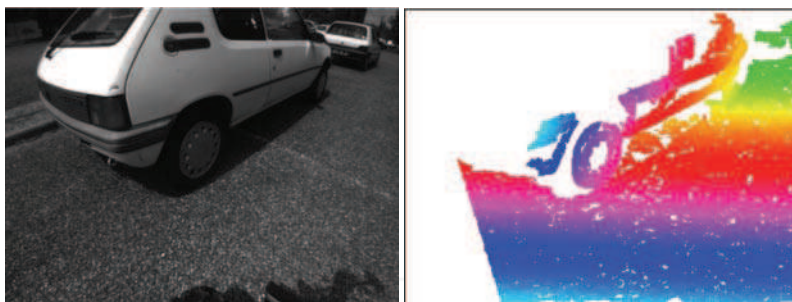

Fig. 3. Obstacle detection to find a parking slot

(figure 4, where the road cannot be detected, due to the lack of texture). For this latter application, images have been acquired from a large baseline stereo rig presented on figure 1 (bottom)².

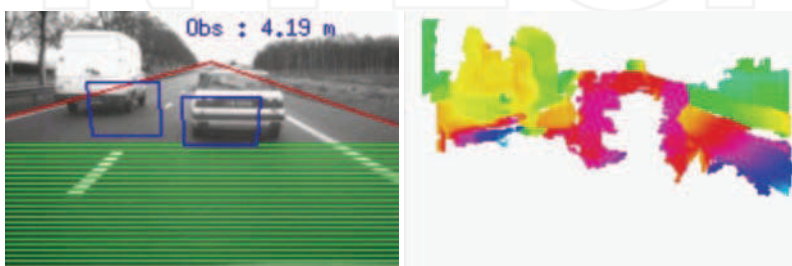

Fig. 4. Obstacle detection on a highway

Figures 2, 3 and 4 (left) present images acquired by the left camera of the stereovision sensor, after rectification: on figures 2 and 4, the green lines on the bottom of the images, indicate the free space before the detected obstacle. On the right, these figures show disparity maps, with progressive color variations with respect to the disparity value.

The next section recalls the main steps of the stereovision algorithm, on which our developments are based. Inputs are images acquired from left and right cameras; the output is the disparity image.

3. The stereovision algorithm

Our stereovision algorithm is classical. It requires an a priori calibration of the stereo rig. The main steps are presented on figure 5.

Initially the original right and left images I_d and I_g are processed independently. The distortion correction and rectification step allows to provide two aligned rectified images IR_d and IR_g : this step consists in applying a warping transform, using tables to transform (u, v) pixel coordinates from the original image frame to the rectified one: here u and v correspond respectively to the line number, and to the column number.

Then a preprocessing is applied on each rectified image, before looking for the best matching between a left pixel (u, v) , with a right pixel $(u, v - D)$, where D is the disparity. The

² Test vehicle of the LIVIC lab in Satory, France

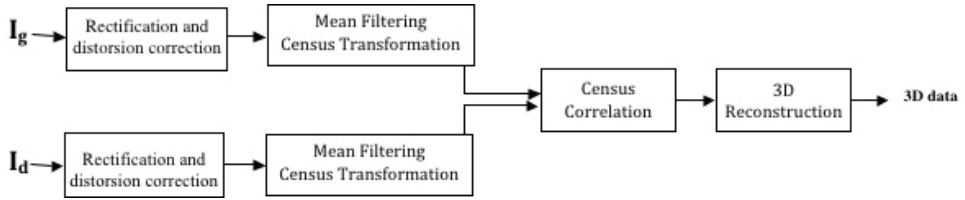

Fig. 5. The description of the stereovision algorithm.

pre-processing function depends on the score used in the matching function. Figure 6 shows a rectified stereo system, i.e. the two image planes are coplanar and lines are collinear. The disparity is equal to zero for two pixels corresponding to a 3D point located at an infinite distance; the maximal disparity D_{max} is tuned according to the minimal 3D points distance that the sensor must detect, e.g. the minimal distance between a vehicle and an obstacle.

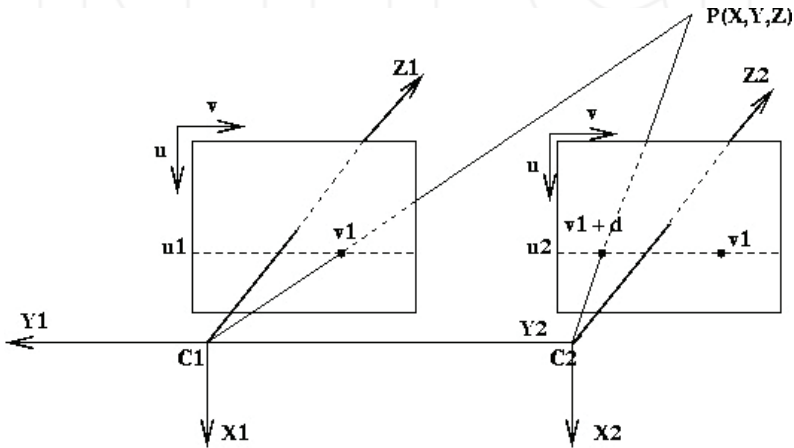

Fig. 6. 3D reconstruction from rectified images.

Several correlation scores -SAD, SSD, ZNCC...- could be used to compare the correlation windows around the left pixel and around every right candidate (figure 7). Here the Census score (Zabih et al. (1994)) is exploited because it does not require floating-point computations and thus is better suited for an hardware implementation. Moreover it is a non-parametric technique based on the relative ordering of pixel intensities within a window W , rather than the intensity values themselves. Consequently, such a technique is robust with respect to the radiometric distortion.

As mentioned here above, before computing the Census transform from the rectified images, a preprocessing, i.e. an arithmetic mean filter, is executed on both images. Let S_{uv} be the set of coordinates in a rectangular sub image window of size $m \times n$ pixels and that is centered on the (u, v) pixel. The arithmetic mean filtering process computes the average value of the original rectified image $IR(u, v)$ in the area defined by S_{uv} . The value of the filtered image $\hat{I}R$ at any point (u, v) is simply the arithmetic mean of all pixels in the region defined by S_{uv} . The formula of this arithmetic mean is given by equation 1.

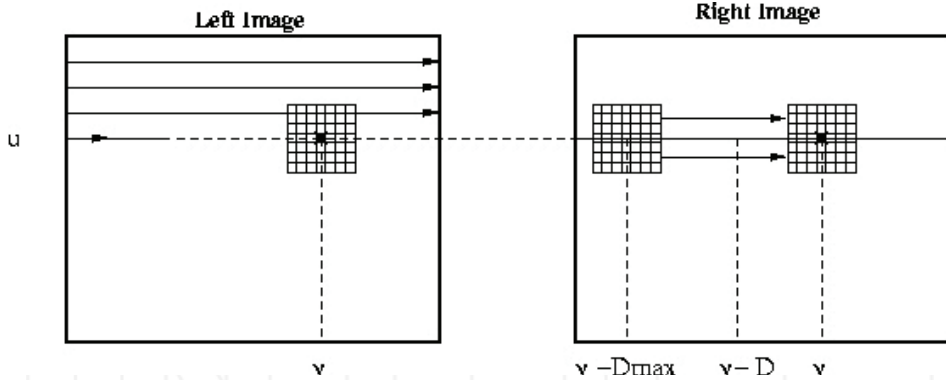

Fig. 7. Stereo matching on rectified images: the correlation principle

$$\hat{IR}(u, v) = \frac{1}{mn} \sum_{(i,j) \in S_{uv}} IR(i, j) \quad (1)$$

This operation can be implemented without using the $1/mn$ scaling factor, only if the correct rank of the filtered pixels is considered. The mean filter simply smoothes local variations in an image. Also in this operation, noise is reduced as a result of blurring.

The Census score is computed from the left and right rectified and filtered images, modified by the Census transform (CT) expressed on equation 2, and illustrated on figure 8.

$$I\hat{RT}(u, v) = \bigotimes_{(i,j) \in S_{uv}} \zeta(\hat{IR}(u, v), \hat{IR}(i, j)) \quad (2)$$

In these transformed images, the intensity value on each pixel (u, v) is replaced by a bit string computed by comparing the intensity $\hat{IR}(u, v)$ with the intensity of neighbour pixels selected in the area defined by S_{uv} , i.e. a $F_c \times F_c$ correlation window centered on (u, v) , where F_c is an odd number. The function ζ computes the relationship between a pixel (u, v) and its nearest neighbors in D_{uv} . This function returns a bit, that is set to one, when the intensity of the point (i, j) is lower than the intensity of the point (u, v) , otherwise the bit is set to zero. The operator \bigotimes denotes concatenation. Finally, $I\hat{RT}(u, v)$ represents the Census transform of the (u, v) pixel: it is a bit string with a length equal to $F_c^2 - 1$.

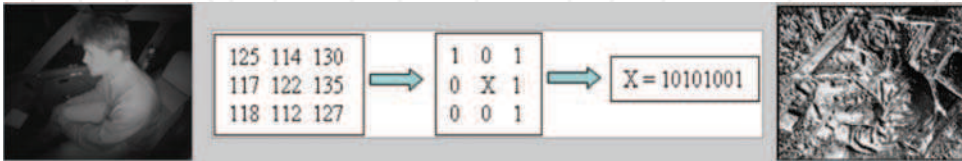

Fig. 8. The CENSUS transform.

The Census score between a left pixel (u, v) and a right one $(u, v - D)$, is evaluated using the Hamming distance, i.e. the binary comparison between two bit strings provided by the Census transform applied independently on the two images. It is given by the number of equal bits between $I\hat{RT}_g(u, v)$ and $I\hat{RT}_d(u, v - D)$, so this score is normalized, from an integer

included between 0 and $F_c^2 - 1$. Equation 3 shows how this score is computed: $I\hat{R}T_l$ and $I\hat{R}T_r$ represent the two Census transformed images (left and right images respectively), \otimes denotes the binary XNOR operation, applied for each bit of the bit string (index i).

For every (u, v) left pixel, all scores are computed with all $(u, v - D)$ right pixels on the same epipolar line for all D in $[0, D_{max}]$. Then, for the (u, v) left pixel, the disparity $D_H(u, v)$ corresponds to the maximum of these Census scores. How to find this maximum? Several classical tests could be used, like it is shown on figure 9 (left): a maximum is valid only if it is discriminant (i.e. high enough), not flat (i.e. sharp enough) and not ambiguous (i.e. the difference between the two first maximal scores is higher than a given threshold). If the maximal score is not valid (lack of texture, ambiguity...), the (u, v) pixel is unmatched.

An error during this matching step, could create false points in the 3D image; a good verification method to avoid these errors, consists in performing pixel correlation first from the left image to the right one, then from the right image to the left one, and to select the best common matching. In the software version, this verification does not increase the computation time. Scores are computed during the left-right run, a potential disparity D is found for each left pixel, and then scores are recorded to be used again during the right-left run. The verification is performed when the left-right run has been processed for a complete line; it is controlled that the same D disparity is found when starting from the right pixel, looking for a maximal score in the left image. If not, the potential disparity D is cancelled in the disparity map.

$$D_H(u, v) = \max_{D \in [0, D_{max}]} \left(\frac{1}{N} \sum_{i=1}^N I\hat{R}T_l(u, v)_i \otimes I\hat{R}T_r(u, v - D)_i \right) \quad (3)$$

Finally, the $D_H(u, v)$ disparity is an integer between 0 and D_{max} : two improvements are possible. First a sub pixel accuracy could be obtained by an interpolation method applied on the score function; on figure 9 (right), the maximal score has been found in $i + 1$; the sub pixel $imax$ value is computed from a parabolic interpolation of the score function. Secondly, a filtering function could be applied to remove potential errors in the disparity image: it consists in segmenting this image in regions, and to remove the very small regions.

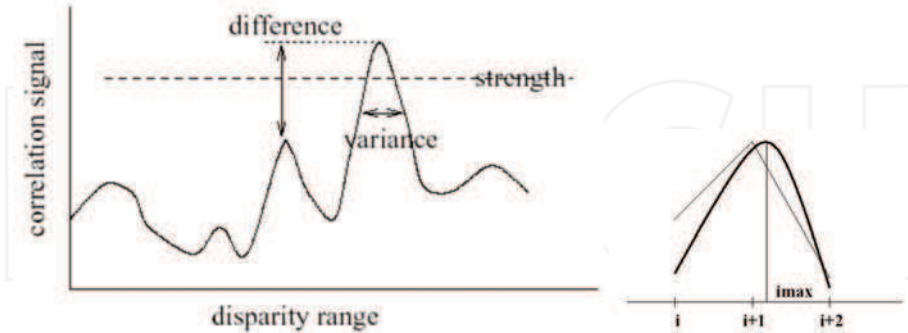

Fig. 9. The disparity validation and computation

Once the Census correlation step has been completed, the 3D reconstruction is computed in the left camera reference frame, as shown in figure 6: the Z axis corresponds to the optical axis, the Y axis is parallel to the image line and oriented towards the left, while the X axis is parallel to the image column and oriented downwards. The 3D reconstruction step requires

the calibration data, i.e. the baseline B (distance between the two optical centers) and similar intrinsic parameters for the rectified images ($\alpha_u, \alpha_v, u_0, v_0$). If a (u_1, v_1) left pixel matched with a $(u_1, v_1 + D)$ right pixel (D negative), it corresponds to a (X, Y, Z) 3D point with the following coordinates:

$$X = \frac{\alpha_v \cdot B \cdot (u_1 - u_0)}{\alpha_u \cdot D}; \quad Y = \frac{B \cdot (v_1 - v_0)}{D}; \quad Z = \frac{\alpha_v \cdot B}{D}$$

These equations show that (1) the disparity is constant for pixels located at a fixed depth Z with respect to the cameras, and (2) the Z error increases as Z^2 , so that the stereo measurements are very noisy for long distances.

Depending on the available computation power, and on the optimization of the code, this algorithm could provide low resolution (320x240 or 160x120) 3D images at video rate; it could be sufficient for robotics application, with a weak robot speed. It does not satisfy real-time requirements for ITS applications or for safety issues when service robots navigate in human environments.

4. Real time stereovision: state of the art

In vision, the term *real time* is generally understood as video-rate (Brown et al. (2003)), i.e. 30 frames per second or higher. Our challenge is real time stereovision at more than 100Hz, for a 640x480 resolution (nb of pixels per line $W = 640$). Using Camera Link connections with two synchronized cameras, images are transmitted with a 40MHz pixel rate (pixel period $T = 25\text{ns}$), giving 130 images per second at this resolution. We aim at a 100Hz image rate, so pixels must be processed on the fly, with a possible delay between successive images if required.

It is yet beyond the possibility of the software implementation, that are generally limited to a video-rate performance with this VGA resolution; several authors proposed in the 90's, such implementations, e.g. the SVS library implemented by K.Konolige (Konolige (1997)), or the stereo machine of T.Kanade (Kanade et al. (1996)).

Only an FPGA implementation can reach a 100Hz performance, and can also meet cost and size requirements. As soon as powerful enough FPGAs appeared, stereovision architectures (Corke et al. (1999)) have been proposed. A variety of architectures able to provide dense disparity maps have been reported since 1995. Most of the integrated real-time stereo systems, are based on Field Programmable Gate Array (FPGA) because of the flexibility given by FPGAs at the moment to realize dedicated hardware architecture, a reasonable low cost (e.g. against ASIC) and an higher processing speed (e.g. against PC).

In 2001, Arias-Estrada et al. (Arias-Estrada et al. (2001)) reported a stereo system able to process 320x240 images at a rate of 71 FPS using SAD scores for stereo matching. The system does not perform any rectification nor distortion correction and uses a Xilinx Virtex FPGA valued at \$2,000 dollars. Darabiha et al. (Darabiha et al. (2003)) developed a four FPGA based system with an estimate cost of \$10,328 dollars able to provide 256 x360 dense disparity map at 30 FPS. A complete stereo vision system with radial distortion correction, Laplacian of Gaussian Filtering and disparity map computation via SAD is proposed by Jia et al. Jia et al. (2004). This system can produce 640 x 480 dense disparity maps with 64 levels of disparity at 30 FPS and has an estimated cost of \$2,582 dollars. Two systems able to process more than 200 images per second, are presented by Georgoulas et al. (Georgoulas et al. (2008)) and Jin et al. (Jin et al. (2010)) respectively. The first system used SAD and the second is based on

Census for computing the disparity map, both system process 640 x 480 images and both of them have a price higher than a thousand dollars.

These systems (Chonghun et al. (2004)) (Sunghwan et al. (2005)) are compared with our own architecture in table 1, considering the FPGA family, the estimated cost (in \$), the resolution of input and output images (Res in $pixel^2$), the frame rate (in Frame Per Second), the score used by the matching method, the maximal disparity (Max in pixels) and finally, the size of the neighbourhood used to compute scores (Win in pixels). The architecture presented in this paper can produced 640 x 480 dense disparity maps at maximum rate of 491 FPS. This stereo vision system performs rectification and distortion correction functions on images acquired from two cameras, and then the correlation function on the transformed images, with a 3 FPGAs pipeline architecture. The overall cost of the proposed hardware, is about \$120, thus making this architecture a good choice for low cost system.

Author	FPGA family	Cost	Resolution	FPS	Score	Max	Win
Arias Estrada	Xilinx Virtex2	2000	320 x 240	71	SAD	16	7 x 70
Darabiha	4 Xilinx Virtex2	10328	256 x 360	30	LWPC	20	N/A
Jia	Xilinx Virtex2	2582	640 x 480	30	SAD	64	9 X 9
Chonghun	Xilinx Virtex2	2983	1024 x 1024	47	SAD	32	16 x 16
Lee	Xilinx Virtex2	7567	640 x 480	30	SAD	64	32 x 32
Georgulas	Altera Stratix2	10797	640 X 480	275	SAD	80	7 X 7
Jin	Xilinx Virtex4	7261	640 x 480	230	Census	64	11 x 11
Our system	3 Altera Cyclone2	120	640 x 480	491	Census	64	7 x 7

Table 1. Comparisons between integrated stereovision algorithms.

Some authors have used FPGA platforms only as a preliminary validation for a ASIC-based implementation: several ones have been developed, e.g. at Zurich ETH Institute (Kuhn et al.(n.d.)) (50Hz for 256x192 images), (Hamette et al. (2006)) (pixel clock limited to 5MHz) or at Daejeon University in Korea (Han et al. (2009)) (30hz for 320x240 images).

5. Real time stereovision: our architecture

Even though its software implementation requires a lot of memory, our stereo algorithm is well adapted for integration on a dedicated architecture: no floating-point computations, boolean operations on bit strings..., even if the software implementation requires a lot of memory. The FPGA implementation has been presented in (Boizard et al. (2005)) (Naoulou et al. (2006)) (Naoulou (2006)). In (Ibarra-Manzano et al. (2009)) and (Ibarra-Manzano et al. (2009)) it is discussed how to generate such an architecture, from tools dedicated to high level synthesis from C programs. Actually, these tools have been used in order to test and evaluate several possible architectures: once these preliminary choices have been done, actual architectures have been generated using classical tools, i.e. QUARTUS for our ALTERA implementation.

Figure 10 presents the general architecture, which is made with five main modules: the acquisition of original left and right images, the rectification, the mean operator, the Census transformation and the Census correlation. Images are not stored completely; pixels are processed on the fly, with a pixel clock defined by the cameras or the communication protocol with the cameras (here CamLink). So the pixel clock is 40MHz, i.e. every module must execute its task every 25ns.

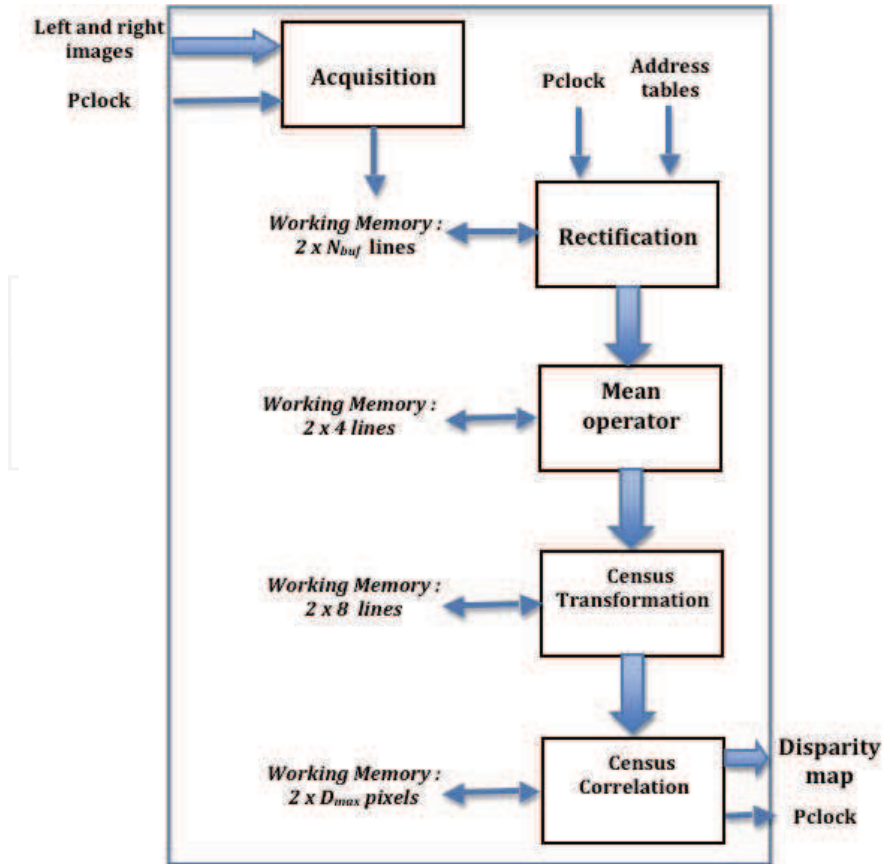

Fig. 10. General architecture.

- Two *Acquisition modules* acquire the two left and right images, here at a 40MHz pixel clock. A given number N_{buf} of lines acquired directly from the cameras, have to be memorized, before executing the next processings; this number depends on the images distortion or misalignment ranges. Cameras are synchronized, so that pixels with the same image coordinates (u, v) are received at the same clock front edge.
- Two *Rectification modules* generate intensities for the rectified left and right pixels, using precomputed address tables. These tables are built offline, from calibration data. The rectified left and right pixels with coordinates $(0, 0)$ are generated with a delay of N_{buf} lines with respect to the acquisition.
- Then two *Mean operator modules* apply a mean filter independently on the two images. This computation is based on the sum of 3×3 window centered around every pixel. Every mean module requires a working memory of 4 lines, avoiding read-write conflicts. The mean pixels are provided with a latency of 3 lines (plus 2 pixels) with respect to the input.
- Outputs from the *Mean operator modules* are inputs for the *Census Transformation (CT) modules* which compute census images; every pixel is replaced by a bitstring computed

from comparisons with their neighbours, in a 7×7 window. So every CT module requires a working memory of 8 lines, and provides the result as a string of 49 bits for every pixel, with a latency of 7 lines (plus 3 pixels) with respect to the input.

- Finally from these left and right CT pixels, the correlation scores are computed and maximum scores are selected by a *Census Correlation module*. When starting from the left image, due to the configuration (see figure 6), the left pixel (u, v) can be matched with right pixels from $(u, v - D_{max})$ to (u, v) . So scores are computed for $(D_{max} + 1)$ couples of pixels; if the maximum score is found for the position $(u, v - D)$, then the output of the module is equal to the disparity D corresponding to the (u, v) coordinates in the disparity map.
- In our implementation, the disparity is directly sent to a CamLink output generator, so that the disparity map is sent at the same frequency than the original images, towards a client system, here a PC only used in order to display the stereo result.

The architecture performance depends on the way scores are computed. Figure 11 presents several options:

- at the top, a sequential architecture is shown. It is a software-like strategy, where $(D_{max} + 1)$ scores are computed in sequence before looking for the maximum: it does not take advantage of the potential parallelization on an hardware implementation.
- in the middle, the scores computation is parallelized only to match left pixels with right ones; it is typically a SIMD operation, so that $(D_{max} + 1)$ identical and synchronous processes can provide all scores in parallel. It is the simpler strategy, because when the left CT pixel (u, v) is available, its corresponding one in the right image is already computed in the right image. The search for the maximum, exploits a dichotomy strategy.
- on the bottom, a dual approach is proposed. Left-right scores are computed and the maximum score is looked for like in the previous case, but a verification is made using right-left scores and right-left matchings.

The dual approach using both the right-left and the left-right stereo matching, requires more memory and more delay. In the software implementation, verifications are applied between every line u ; all scores are memorized when applying the left-right stereo matching for every (u, v) pixel on this line; so scores are stored in a $(D_{max} + 1) \times 640$ 2D table; the left-right matching for a (u, v) left pixel consists in finding the maximum score on the line v of the score table; the right-left matching for a (u', v') right pixel consists in finding the maximum score for a diagonal of the score table. These two maximums (on the line and the diagonal), must be the same. This approach is sequential, thus not adapted to hardware implementation; a dedicated architecture is proposed hereafter, based on parallel searching for the left-right and the right-left matchings. Results presented in the section 7 are obtained with the parallel architecture, without right-left verification.

At the end, the final latency between the original acquisition and the generation of the disparity for a (u, v) pixel, can be approximated by $(N_{buf} + 10)$ lines, plus 5 pixels:

- the number of lines is given both by the distortion factor of the original images, and by the window size used to compute the Mean operator and the Census Transformation;
- the extra delay of 5 pixels, is given also by the window size, and also by pipeline stage required in order to compute the maximal score.

Each module is detailed in the following subsections.

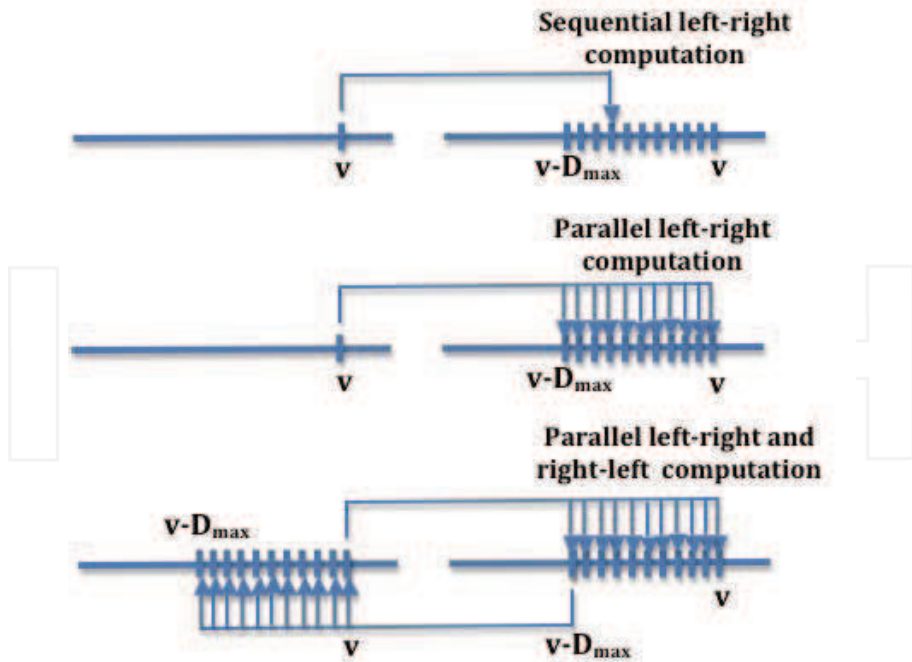

Fig. 11. Sequential vs parallel architectures.

5.1 The rectification.

This function applies an homography to the two images, and correct distortions if they cannot be neglected. So, it is a simple coordinate transform, using for every image, two address tables generated off line, one for u , one for v . These tables give the correspondance between the (u, v) coordinates in the original image and the (u_{rect}, v_{rect}) ones in the rectified image. Two solutions could be implemented:

- N_{buf} lines of the original image are recorded before activating the stereo algorithm on successive rectified pixels; first "inverse" address tables are used to transform every rectified pixel coordinates and to pick up its intensity in the buffer.
- N_{buf} lines of the rectified image are initialized from the pixels of the original image using "direct" address tables. Some rectified pixels could remain not initialized, creating artificial "holes" in the rectified image (Irki et al. (2007)).

The two solutions have been implemented; the first one is the more efficient.

The resolution of the rectified images could be reduced with respect to the original one; in our implementation, the pixel clock is 40MHz for the *acquisition module* of 640x480 images (25ns between two pixels of the original images). The frequency could be reduced to 10MHz (100ns between two pixels) if rectified images are generated with a 320x240 resolution. Here the same frequency is used for all modules, so that the final disparity map has the same resolution than original images.

Address tables are generated especially to correct image distortions. Figure 12 presents possible configurations for the rectified images with respect to the corrected original ones.

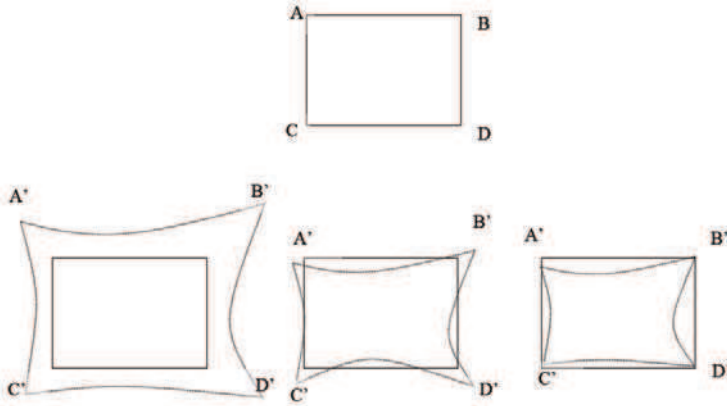

Fig. 12. Possible configurations for the rectified and corrected images.

Let us note (A, B, C, D) the four original image corners in pixel coordinates, so $A = (0, 0); B = (0, 639); C = (479, 0); D = (639, 479)$. Let us note (A', B', C', D') the four rectified image corners. Generally wide-angle lenses are used on our robotics application, so that images are mainly warped due to barrel radial distortions. So the distortion correction replaces every pixel of the original images on its image radius, creating a zooming effect, i.e. pixels are further from the image center. The corrected images could be selected as shown on the bottom line: on the left, the rectified cameras have a smaller view field than the original ones and the resolution is higher; on the right, the view field is the same, but keeping the same image size, the resolution is smaller.

So address tables are implemented as a 2D array; for every (u_{rect}, v_{rect}) pixel of the rectified image, a 32 bits word is read in the address table. This word encodes for each rectified pixel, the position of the corresponding one in the original image. It is given as a position in the current circular buffer of N_{buf} lines, (U_{int}, V_{int}) , plus four factors $(\Delta a, \Delta b, \Delta c, \Delta d)$ required to apply a bilinear interpolation. The intensity in the position (u_{rect}, v_{rect}) of the rectified image, is computed as:

$$I_{rect}(u_{rect}, v_{rect}) = \frac{\Delta a \cdot I_{buf}(U_{int}, V_{int}) + \Delta b \cdot I_{buf}(U_{int}, V_{int} + 1)}{\Delta c \cdot I_{buf}(U_{int} + 1, V_{int}) + \Delta d \cdot I_{buf}(U_{int} + 1, V_{int} + 1)} + \quad (4)$$

The size N_{buf} of the circular buffer filled by the *Acquisition module* must be selected so that the required original pixels are in the buffer when applying this interpolation. In our implementation, using wide-angle lenses, $N_{buf} = 30$.

5.2 The arithmetic mean filter.

Rectified pixels are processed on the fly, synchronously with the acquisition of the original pixels, but with a latency of $N_{buf} * W * Tns$ ($480\mu s$ with $N_{buf} = 30; W = 640; T = 25ns$). Once initialized, a rectified pixel is transformed by a simple mean filter, using a 3×3 window. The filtering process requires to record 4 lines (3 to compute the mean, one to memorize the incoming pixels of the next line). A filtered pixel is generated with a latency of $(2W + 2) * Tns$. The mean computation is achieved in two steps; namely horizontal and vertical additions. The architecture of the corresponding module is shown on Fig. 13. Three registers as shown

in figure 14, are used to perform the horizontal addition. Three successive pixels are stored in three shift registers. These shift registers are connected to two parallel adders of eight bits so that the result is coded in ten bits. The result of horizontal addition is stored in a memory, which is twice as large as the image width. The vertical addition is computed by taking the current horizontal addition result plus the stored horizontal addition of the two previous lines. The arithmetic mean of the nine pixels window is coded in 12 bits. The normalization (division by 9) is not required here, because the next function only compares pixel intensities.

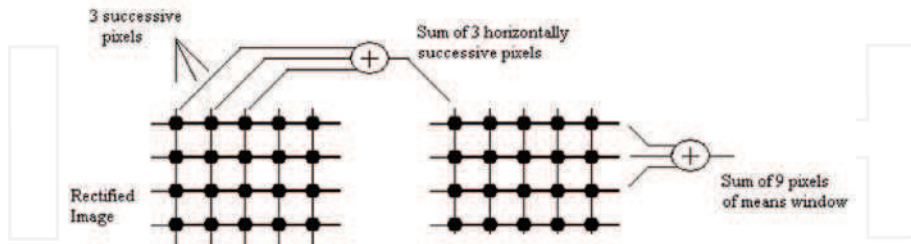

Fig. 13. Architecture for the module *Arithmetic mean filter*.

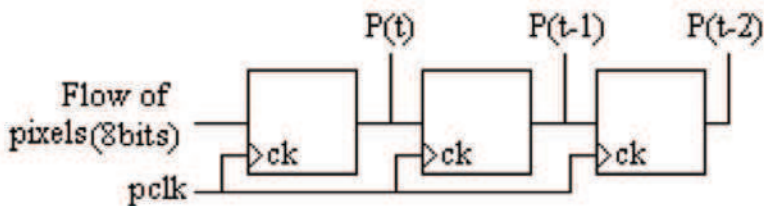

Fig. 14. Shift registers in order to memorize 3 successive pixels.

5.3 The Census transform.

Pixels filtered by the mean operator are provided by the previous step at every pixel clock; they are used as inputs for the Census transform module. This transformation encodes all the intensity values contained in a $F_c \times F_c$ window as a function of its intensity central value. The process is very simple, but it generates long bit strings if F_c is increased. After analysis on synthetic and real images, F_c was set to 7, giving for every Census pixel, a string of 48 bits; fortunately only a circular buffer of D_{max} strings computed from the left and right images, must be recorded before executing the *Census Correlation module*. The Census Transform requires to record $F_c + 1$ lines, and a transformed pixel is generated with a latency of three lines plus four pixels, $(4W + 4) * T_{ns}$.

The architecture of this module is described on Fig. 15. This module requires a circular buffer of 8 lines in order to store results of the Mean operator, that is to say 12 bits pixels. The size of the working memory is equal to the image width ($W = 640$) minus the width of the searching window (7 pixels in our case), because Census bitstring cannot be computed for pixels close to the image limits, so 60,8Kbits. Moreover this module requires a matrix of 7×7 shift registers, so that at every pixel clock, seven successive pixels on seven successive lines centered on a (u, v) pixel are stored synchronously. Let us note that at this same period, the $(u + 4, v + 4)$ pixel is computed by the *Rectification module*.

Once pixels of the 7x7 Census window are stored in registers, then the central procedure of the Census transform is executed: the central pixel of the Census window is compared with its 48 local neighbours. It requires that all corresponding registers are connected to comparators activated in parallel as shown on Fig. 15. Finally, the Census result is coded on 48 bits, where each bit corresponds to a comparator output.

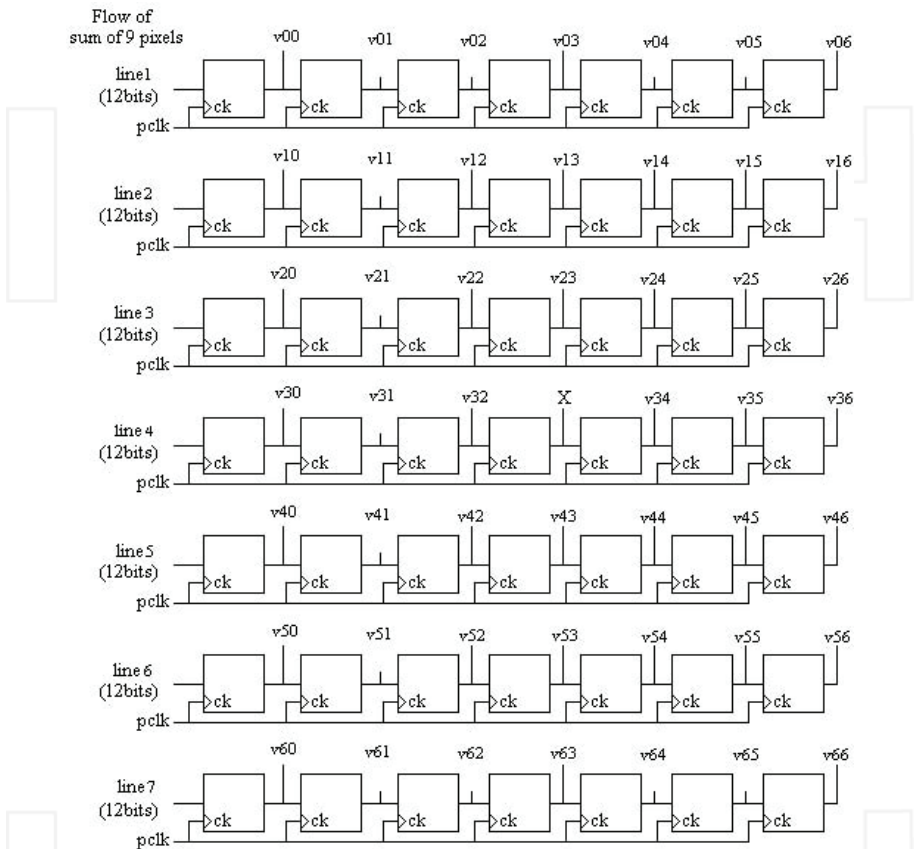

Fig. 15. Architecture for the module *Census transform*.

5.4 The Census correlation.

Correlation task is intended to link up right Census image with left one or vice versa, taking into account that, images contain objects that are common between them. As it is well known, correlation task serves to find the object apparent displacement, called disparity measurement. Stereo matching must compute similarity measurements (or scores), between left and right pixels that could be matched; matchings are selected maximizing the similarity scores. So the module consists of two main steps: in one hand, the computation of the similarity scores, in another hand, the maximum score search.

As shown on figure 7, the *Census Correlation module* has been designed at first from the left image to the right one, because it allows to minimize the latency time.

Figure 16 shows the corresponding module architecture for the left-right correlation. Firstly all $D_{max} + 1$ scores are computed in parallel; the last 64 Census codes computed by the previous module in the right image, are synchronously stored in shift registers (each one is a word of 48 bits), depicted as D_0 (for (u, v)), D_1 (for $(u, v - 1)$), D_2 (for $(u, v - 2)$)... on the left of Fig. 16. Both registers and the left Census code computed for the current processed pixel in (u, v) position, are the inputs of $XNOR$ binary operator which delivers 48 bits as output; if a bit in the right Census code is the same than the corresponding one in the left Census code, the resulting bit given of the $XNOR$ operation will be set to one; on the contrary, if compared bits are different, the $XNOR$ operation returns zero. The 48 bits returned by every $XNOR$ operator, are summed, in order to find the number of equal bits in the compared Census codes. This number add_i gives the similarity score between the (u, v) left pixel with the $(u, v - i)$ right one. So scores are integer numbers from 0 (if all bits of the Census codes are different) to 48 (identical Census codes).

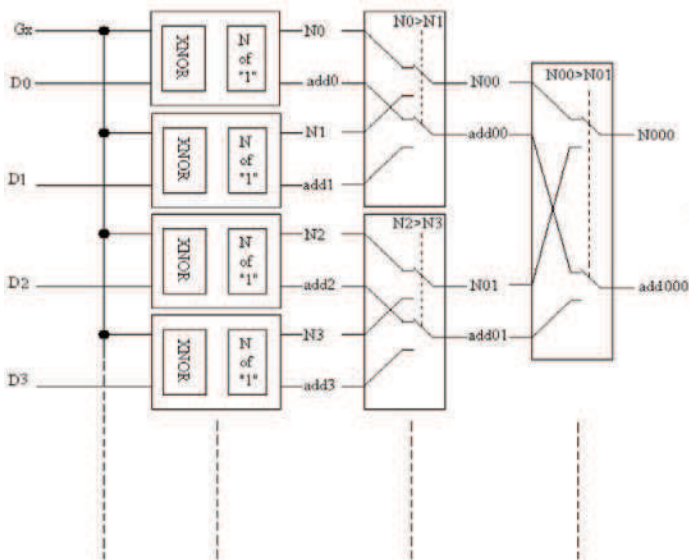

Fig. 16. Architecture for the module *Census correlation*.

Then these scores are compared in order to find the N_i position for the add_i maximum score; it is done by comparing scores for adjacent potential matches. The search for the maximum score is processed by pyramidal comparisons; for a 2^N array, it requires N cycles. Here $D_{max} = 64$, so the search for the maximum score, requires 6 steps.

5.5 The left-right verification.

The Census correlation could be made in parallel from the left image to the right one and from the right image to the left one, but not synchronously. With rectified and non convergent cameras, when a left pixel is read, the matched one in the right image is already recorded amongst the D_{max} circular buffer. On the contrary, when a right pixel is read, the matched one in the left image will be acquired during the D_{max} next periods. This time-lag makes the architecture more complex, and adds a latency of D_{max} periods.

Nevertheless, the result is improved using this left-right verification. Indeed, when we search for the maximum scores, several scores could be identical for different disparities. In the software version, basic verification tests on the found maximum, are made to filter bad matchings (see figure 9(left)). These tests are not implemented in the previous module. So a verification step allows to eliminate these false disparities, comparing disparities provided by the left-right and right-left Correlation processes.

Figure 17 presents the proposed architecture. Two *Census Correlation modules* are executed in parallel; the first one has been described in the previous section. The second one is identical, but a right Census code is compared with the $D_{max} + 1$ next computed left Census codes. So this right-left search requires an extra latency (here 64 pixel periods more). All computed disparities are stored in shift registers: so this module requires $2 \times D_{max}$ registers (here 6 bits registers, because disparity is between 0 and 63). The verification consists in comparing disparities given by the two approaches: if disparity d is given by the left-right search, a disparity $D_{max} - d$ must be given by the right-left search. If this test is not satisfied, the disparity is not valid.

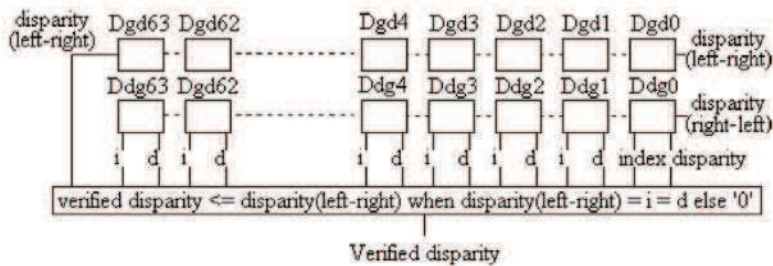

Fig. 17. Architecture for the module *left-right verification*.

Finally, a disparity is generated for a given pixel with a latency of $(N_{buf} * W + (2W + 2) + (4W + 4) + 2 * D_{max}) * T_{ns}$ with all steps. By now the filtering algorithm used in the software version, is not integrated on a FPGA.

6. Real time stereovision: our FPGA-based implementation

6.1 First validations without rectification

The stereovision algorithm has been firstly implemented in VHDL on the QUARTUS development tool (*Altera Quartus reference manual* (n.d.)), and then loaded and executed on the evaluation kit NIOS-DEVKIT-1S40 (*Altera Stratix reference manual* (n.d.)), equipped with a STRATIX 1S40 with 41250 logic elements (LEs) and 3.4Mbits of embedded RAM memory. The embedded memory was not sufficient to test the rectification function. So it was not implemented in this first implementation. Cameras were aligned thanks to mechanical devices shown with our preliminary acquisition setup on figure 18 presents :

- the evaluation kit was connected to two JAI cameras, mounted on micro-actuators, so that an expert operator could manually align the two image planes.
- Images with a 640x480 resolution, are transferred to the evaluation kit at 40MHz, using CameraLink serial communication protocol.
- it was intended to study a multispectral version of this perceptual method, fusing sensory data provided by classical CMOS cameras with FIR ones (far infrared, using micro



Fig. 18. Three cameras (the central FIR) connected to the computing unit.

bolometers).

The Census Transform and the Census Correlation functions have been evaluated on this first setup; this system allowed to learn about the required resources in LEs, in memory and in EABs (Embedded Array Blocks). Figure 19 shows the relationships between numbers of used LEs (left) and of used memory bits (right) with the F_c and W parameters, considering a maximal distortion of $H/4$ (with generally $H = 2/3W$) and a maximal disparity $D_{max} = 63$. It appears clearly that the most critical requirement comes from the memory consumption, and especially, from the number of available EABs, due to the fact that one EAB (4096 bits) allows to record only one image line only if $W < 512$.

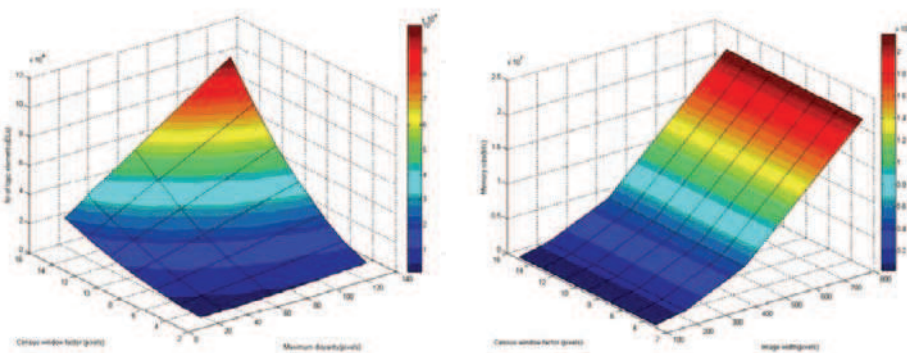

Fig. 19. The resource requirements with respect to the image size and the size of the correlation window.

This static analysis about the resources requirements, allowed us to select what could be the most well suited FPGA in the ALTERA family, in order to implement our stereo algorithm. Due to economic requirements (low cost, low power consumption), the Cyclone family was mainly considered: the number of LEs available on the 1C20 chip (20000) could be sufficient, but not the number of EABs (64). The CycloneII family has been selected (1.1Mbits of embedded memory, up to 64000 LEs) to design a computing unit adapted for the stereovision algorithm.

6.2 A multi-FPGAs computing box for stereovision

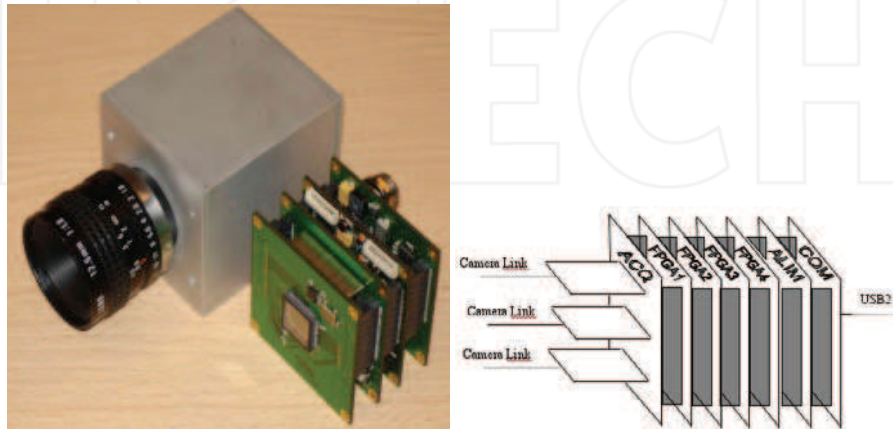

Fig. 20. The developed multi-FPGAs platform (right), inspired from the DTSO camera (left)

A modular electronic computing board based on a CycloneII FPGA, was designed by Delta Technologies Sud Ouest (*Delta Technologie Sud-Ouest Company* (n.d.)), for this project about stereovision, but also, for high-speed vision applications using smart cameras. DTSO has designed an intelligent camera called iCam (figure 20), made of at least 4 boards: (1) the sensor board, equipped with a 1280x1024 CMOS array, (2) the computing board, equipped with a CycloneII FPGA with only 18000 LEs, but with two 1MBytes banks of external memories (read access time: 50ns, with the possibility to read two bytes in parallel), (3) the power supplying board and (4) an interface board, allowing an USB2 connection (8MBytes/s) between the camera and a client computer. Recently a Ethernet version (Wifi or wired) has been designed, integrating in the camera a PowerPC on Linux, in order to manage the TCP/IP protocol, and to allow to use a network of communicating iCam cameras.

Depending on the application, it is possible to integrate in iCam several computing boards, connected by a chained parallel bus: an algorithm could be parallelized according to a functional repartition (sequences of functions executed in pipeline) or a data distribution between the computing boards.

iCam is a smart modular camera: how to convert this design in order to deal with stereovision? Depending on the sensor baseline, two configurations could be considered to implement a real-time stereovision sensor.

- For applications involving small view fields, like cockpit monitoring in a car (figure 1(top right)), the stereo baseline could be less than 10cm, like for on-the-shelf stereo sensors (*Videre Design Company* (n.d.)) (*Point Grey Design Company* (n.d.)). The iCam architecture

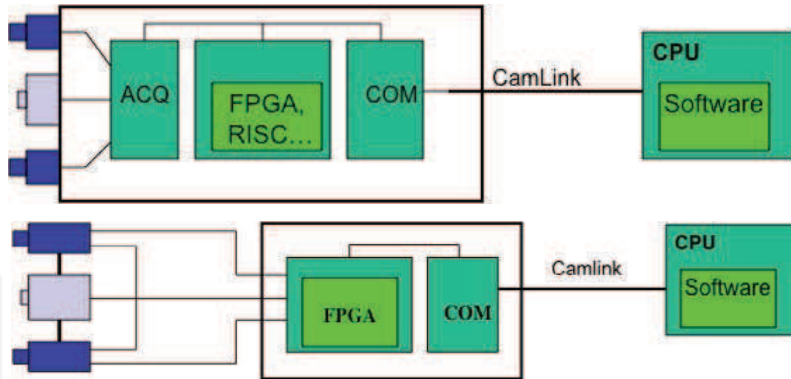

Fig. 21. Two possible configurations, with or without sensor integration.

could be adapted by rigidly coupling two sensor boards (figure 21(top)) and to map four computing boards to the functional decomposition presented on figure 5. Thanks to the rigidity, such a stereo sensor could be calibrated off line.

- A larger baseline could be required for applications like obstacle detection on a motorway with a view field up to 50m. (figure 1(bottom)). For such applications, only a computing box is integrated using the ICam architecture without the sensor board: a Camera Link interface has been developed to connect up to three cameras to this box (figure 21(bottom)). With large baselines, self-calibration methods will have to be integrated to make on line estimation or on line correction (Lemonde (2005)) of the sensor parameters, especially of the relative situation between left and right cameras.

The stereovision computing box is presented on figure 22; only three FPGA boards are integrated by now, because like it will be seen in the section 7, the CycloneII resources provided by three boards are sufficient with a wide margin. As presented on figure 23, our system has a pipeline architecture; two image flows go through all FPGAs:

- FPGA1 receives the two original images; it performs the rectification function on the left one; outputs are the rectified left image, and the original right one.
- FPGA2 performs the rectification function on the right original image; outputs are the two rectified images.
- FPGA3 performs the correlation function; outputs can be selected, using jumpers. Generally it is the disparity map, and the left rectified image (for display purpose on the PC).

7. Real time stereovision: evaluations

7.1 Benchmarking on the Middlebury data set

The performance of our integrated stereo architecture has been evaluated using two methods. First, a simulation of the HDL code has been performed on images *Tsukuba*, *Teddy*, *Venus and Cones* extracted from the Middlebury stereo dataset (Scharstein et al. (2002)). Percentages of bad pixels are computed on different regions (all, non-occluded, discontinuity) of the disparity images, according to the method proposed for benchmarking stereo algorithms in (Scharstein et al. (2002)):

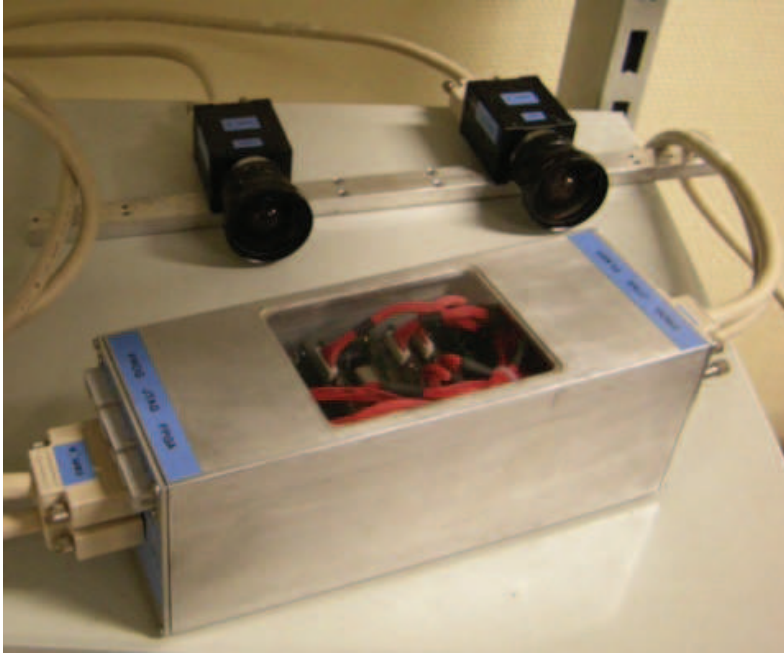

Fig. 22. An integrated version on a multi-FPGAs architecture.

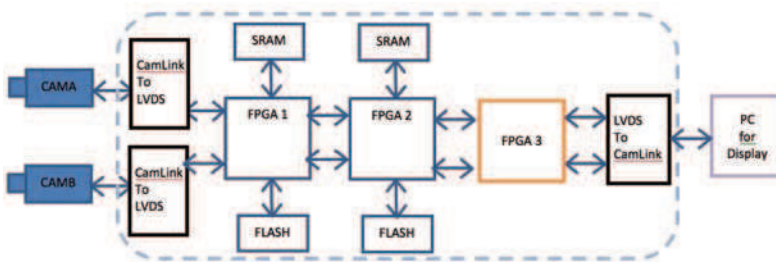

Fig. 23. The hardware computing box for the stereovision algorithm.

$$B = \frac{1}{N} \sum_{(x,y)} (d_C(x,y) - d_T(x,y) > \epsilon_d)$$

where N is the number of pixels in the disparity map, $d_C(x,y)$ is the computed disparity, $d_T(x,y)$ is the ground truth disparity, and ϵ_d is the disparity error tolerance.

Table 2 presents on the three first columns, these percentages for the raw disparity images; the mean percentage of bad pixels for all images is 37,5%. Then a filtering operation is applied on the raw disparity images, using a median filter on a 5x5 window, followed by an erode operation on a 5x5 structuring element. Table 2 presents on the three last columns, these percentages for the filtered disparity images; the mean percentage of bad pixels is decreased to 29,4%.

Image name	nonocc	disc	all	nonocc	disc	all
<i>Tsukuba</i>	36.0	43.1	37.4	26.0	27.7	33.9
<i>Teddy</i>	36.4	37.5	47.9	28.1	29.3	42.3
<i>Venus</i>	36.6	42.8	48.5	28.2	35.3	40.5
<i>Cones</i>	19.6	28.4	36.1	12.2	21.8	27.3

Table 2. Percentages of errors for the raw and filtered disparities, computed on the four images extracted from the Middlebury data set.



Fig. 24. Results provided by our architecture with a Post-Processing applied to images from the Middlebury data set

7.2 Evaluation from real-time experiments

Second, performances are evaluated from real-time image sequences acquired on indoor scenes with a stereo rig connected to the multi-FPGAs system presented on figure 22. A result is presented on figure 25. This figure shows the left stereo image (top) and the raw disparity image (bottom left) sent by the multi-FPGAs system on a CameraLink connection to a PC, and the filtered disparity image (bottom right) processed by software. The PC can filter and display these disparity images only at 15Hz; the filtering method will be soon implemented on a fourth FPGA board which will be integrated on our system.

Table 3 shows how many resources are used on the three FPGAs on which our architecture is integrated. The synthesis process is carried out thanks to Altera Quartus II v 9.0 Web

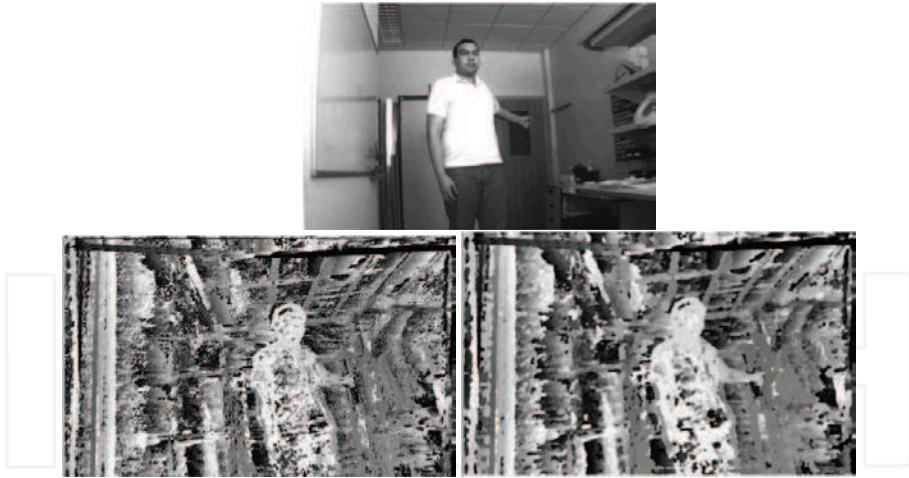

Fig. 25. Results provided by our architecture implemented on a multi-fpgas configuration: (top) original image, (bottom) disparity images before and after filtering

Board	Used LEs	Available LEs	% Used LEs	% Used Memory	Max Frequency
FPGA 1	868	18752	5%	31%	160 MHz
FPGA 2	868	18752	5%	31%	160 MHz
FPGA 3	13582	18752	72%	37%	151.31 MHz

Table 3. Resources required for the presented algorithm.

Edition. Theoretically, the maximal frames per second rate of our stereo implementation, could be 490 FPS, taking 151.31 MHz as the maximal frequency for the pixel clock: $N_{images/s} = N_{pixels/s} / size_{image}$ (so 491 151310000/640x480). Our real tests are based on JAI cameras which have a 40MHz pixel clock; so now our system provides 130 disparity images/s. The CameraLink connection is sufficient in order to send this data flow to an host computer; by now, it is a PC which only displays disparity images at 15Hz.

Furthermore, another relevant fact is that FPGAs 1 and 2 on which the rectification architectures are implemented, are underused according to the percentage of used logic elements (LEs), so it could be possible to use a smaller and cheaper FPGA for these tasks.

8. Conclusions

This paper has described the current results of a project about the design and the implementation of a smart perceptual subsystem, that could be mounted on a mobile platform in order to execute very computationally demanding functions, like obstacle detection. Up to now only the acquisition of 3D data from visual sensors has been considered, using the integration of a classical correlation-based stereovision algorithm on a processing unit made of connected FPGA-based boards. This processing unit is fed at 40MHz by images acquired by two or three cameras through Camera Link connections, and can provide disparity images at more than 100Hz with a 640x480 resolution on a Camera Link output connected to a client computer. By now, other perceptual functions must be executed on the client computer because either they are too complex (like image segmentation) or they require too many

floating-point computations : filtering of the disparity map, 3D reconstruction, obstacle detection either directly from the disparity map or from the 3D image...

Up to now, because of some simplifications made on the original stereovision algorithm, disparity maps acquired by our stereo sensor, are very noisy and contain too many artefacts. We are currently improving these results, by implementing on FPGA, interpolations and verifications already validated on the software version.

Moreover, assuming that the ground is planar, disparity maps can be directly exploited to detect obstacles on the ground, using the v-disparity concept (Labayrade et al. (2002)), so that a probabilistic obstacle map could be provided to the client computer. It is intended to estimate also on the smart sensor, the relative speed of the detected obstacles. Finally other

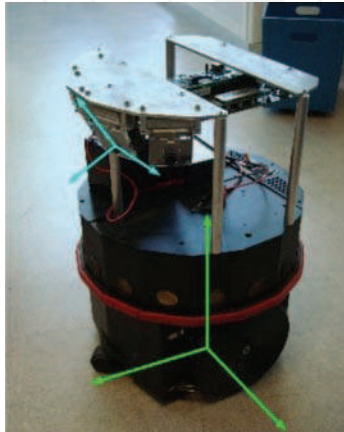

Fig. 26. A demonstrator for a smart multi-cameras sensor for obstacle detection.

algorithms, not directly based on stereovision, are currently studied, in order to design and implement smart sensors for obstacle detection. First a multi-cameras system, devoted to ground-obstacle segmentation (Devy et al. (2009)) has been developed for service robotics: figure 26 presents our demonstrator, currently equipped with four cameras. Then we develop an heterogeneous multi-cameras system, made with a classical CMOS camera and an infrared sensor (in the 8-12 μ m bandwidth), devoted to obstacle detection in bad visibility conditions.

9. Acknowledgments

This work has been funded by a Midi-Pyrénées region project in France and by the ECOS Nord action C07M01 about the international scientific cooperation between France and Columbia.

- Mario Ibarra Manzano was supported by the scholarship 183807 granted by CONACYT and SEP administration in Mexico.
- Diego Botero Galeano is supported by the FUI project SART, funded by the french ministry of Industry.
- Zohir Irki is supported by the *Laboratoire des Systèmes Numériques (LSN/UERAuto)*, *Ecole Militaire Polytechnique (EMP)*, Alger, Algeria.
- Philippe Fillatreau is currently Assistant Professor at the Laboratoire Genie de Production (LGP) of the *Ecole Nationale d'Ingénieurs de Tarbes (ENIT)*.

10. References

- Altera Quartus reference manual (n.d.). URL: <http://www.altera.com/literature/lit-qts.jsp>.
- Altera Stratix reference manual (n.d.). URL: <http://www.altera.com/products/devices/stratix/features/stx-architecture.html>.
- Arias-Estrada, M. & Xicotencatl, J. M. (2001). Multiple stereo matching using an extended architecture, *Proc. 11th Int. Conf. on Field-Programmable Logic and Applications (FPL)*, G. Brebner and R. Woods, Eds. London, UK: Springer-Verlag, pp. 203–212.
- Boizard, J.L., Naoulou, A., Fourniols, J., Devy, M., Sentenac, T. & Lacroix, P. (2005). Fpga based architectures for real time computation of the census transform and correlation in various stereovision contexts, *7th International workshop on Electronics, Control, Modelling, Measurement and Signals (ECMS'2005)*, 7p.
- Brown, M., Burschka, D. & Hager, G. (2003). Advances in computational stereo., *IEEE Trans. on Pattern Analysis and Machine Intelligence*, Vol. 25(8), pp. 993–1008.
- Chonghun, R., Taehyun, H., Sungsik, K. & Jaeseok, K. (2004). Symmetrical dense disparity estimation: algorithms and fpgas implementation, *Consumer Electronics, 2004 IEEE International Symposium on* . Sept. 1-3, pp. 452–456.
- Corke, P. & Dunn, P. (1999). Frame-rate stereopsis using non-parametric transforms and programmable logic, *Proc. IEEE Int. Conf. on Robotics and Automation (ICRA)*.
- Darabiha, A., Rose, J. & MacLean, W. (2003). Video-rate stereo depth measurement on programmable hardware, *Proc. IEEE Conf. on Vision and Pattern recognition (CVPR2003)*, Madison (USA).
- Delta Technologie Sud-Ouest Company (n.d.). URL: <http://www.delta-technologies.fr>.
- Devy, M., Giralt, A. & Hernandez, A. M. (2000). Detection and classification of passenger seat occupancy using stereovision, *Proc. IEEE Symp. on Intelligent Vehicles (IV2000)*, Dearborn (USA), pp.714-719.
- Devy, M., Ibarra Manzano, M., Boizard, J.L., Lacroix, P., Filali, W. & Fourniols, J. (2009). Integrated subsystem for obstacle detection from a belt of micro-cameras, *14th International Conference on Advanced Robotics (ICAR 2009)*, Munich (Germany), 6p..
- Georgoulas, C., Kotoulas, L., Sirakoulis, G., Andreadis, I. & Gasteratos, A. (2008). Real-time disparity map computation module, *Microprocessors And Microsystems*, Vol. 32(3), pp. 159–170.
- Hamette, P. L. & Troster, G. (2006). Fingermouse - architecture of an asic-based mobile stereovision smart camera, *Wearable Computers, IEEE International Symposium*, Vol. 0, pp. 121–122.
- Han, S., Woo, S., Jeong, M. & You, B. (2009). Improved-quality real-time stereo vision processor, *VLSI Design, International Conference on*, Vol. 0, pp. 287–292.
- Ibarra-Manzano, M., Almanza-Ojeda, D., Devy, M., Boizard, J.L. & Fourniols, J. (2009). Stereo vision algorithm implementation in fpga using census transform for effective resource optimization, *Proc. 12th Euromicro Conference on Digital System Design, Architectures, Methods and Tools (DSD'2009)*, Patras (Greece), pp. 799–805.
- Ibarra-Manzano, M., Devy, M., Boizard, J.L., Lacroix, P. & Fourniols, J. (2009). An efficient reconfigurable architecture to implement dense stereo vision algorithm using high-level synthesis, *Proc. 19th Int. Conf. on Field Programmable Logic and Applications (FPL 2009)*, Prague (Czech Republic).
- Irki, Z., Devy, M., Fillatreau, P. & Boizard, J.L. (2007). An approach for the real time correction of stereoscopic images, *8th International Workshop on Electronics, Control, Modelling,*

Measurement and Signals (ECMS 2007) & Doctoral School (EDSYS, GEET), Liberec (Czech Republic).

- Jia, Y., Zhang, X., Li, M., & An, L. (2004). A miniature stereo vision machine (msvm-iii) for dense disparity mapping, *Proc. 17th Int. Conf. Pattern Recognition (ICPR), Cambridge, U.K.*, Vol. 1, p. 728–731.
- Jin, S., Cho, J., Pham, X., Lee, K., Park, S., Kim, M. & Jeon, J. (2010). Fpga design and implementation of a real-time stereo vision system, *IEEE Trans. on circuits and systems for video technology* Vol. 20(1), p. 15–26.
- Kanade, T., Yoshida, A., Oda, K., Kano, H. & Tanaka, M. (1996). A stereo machine for video-rate dense depth mapping and its new applications, *Proc IEEE Int. Conf. on Computer Vision and Pattern Recognition (CVPR)*.
- Konolige, K. (1997). Small vision systems : Hardware and implementation, *Proc. 8th Int. Symp. on Robotics Research (ISRR), Hayama (Japan)*.
- Kuhn, M., Moser, S., Isler, O., Gurkaynak, F. K., Burg, A., Felber, N., Kaeslin, H. & Fichtner, W. (2003). Efficient asic implementation of a real-time depth mapping stereo vision system, *Proc. IEEE Int. Symp. Micro-Nano Mechatronics and Human Science*, Vol. 3, pp. 1478–1481.
- Labayrade, R., Aubert, D. & Tarel, J. (2002). Real time obstacle detection in stereo vision on non flat road geometry through v-disparity representation, *Proc. IEEE Symp. on Intelligent Vehicle (IV2004), Versailles (France)*.
- Lemonde, V. (2005). Stéréovision embarquée sur véhicule : de l'auto-calibrage à la détection d'obstacles, *Phd report, institut national des sciences appliquées, Toulouse (France), Laboratoire d'Architecture et d'Analyse des Systèmes (C.N.R.S.)*.
- Lemonde, V. & Devy, M. (2004). Obstacle detection with stereovision, *Mechatronics & Robotics 2004 (MECHROB'04), Aachen (Allemagne)*, Vol.3, pp. 919–924.
- Lemonde, V. & Devy, M. (2005). Obstacle detection with stereovision for parking modeling, *Proc. European Congress Sensors & Actuators for Advanced Automotive Applications (SENSACT'2005), Noisy-Le-Grand (France)*, 10p.
- Matthies, L. (1992). Stereo vision for planetary rovers: Stochastic modelling to near-real time implementation, *Int. Journal on Computer Vision*, Vol. 8(1).
- Naoulou, A. (2006). Architectures pour la stéréovision passive dense temps réel : application à la stéréo-endoscopie, *Phd report, Université Paul Sabatier, Toulouse (France), Laboratoire d'Architecture et d'Analyse des Systèmes (C.N.R.S.)*.
- Naoulou, A., Boizard, J.L., Fourniols, J. & Devy, M. (2006). An alternative to sequential architectures to improve the processing time of passive stereovision algorithms, *Proc. 16th Int. Conf. on Field Programmable Logic and Applications (FPL'2006), Madrid (Spain)*, 4p., pp. 821–824.
- Point Grey Design Company: BumbleBee2 sensor (n.d.). URL: <http://www.dnai.com/mclaughl>.*
- Scharstein, D. & Szeliski, R. (2002). A taxonomy and evaluation of dense two-frame stereo correspondence algorithms, *Int. Journal on Computer Vision*, Vol. 47(1-3), pp. 7–42.
- Sunghwan, L., Jongsu, Y. & Junseong, K. (2005). Real-time stereo vision on a reconfigurable system, *Proc. Int. Conf. SAMOS, Lecture notes in computer science, ISSN 0302-9743*, pp. 299–307.
- Videre Design Company (n.d.). URL: <http://www.dnai.com/mclaughl>.*
- Zabih, R. & Woodfill, J. (1994). Non-parametric local transforms for computing visual correspondence, *Third European Conf. on Computer Vision (ECCV), Stockholm (Sweden)*.