



HAL
open science

Temporal pattern recognition in retinal ganglion cells is mediated by dynamical inhibitory synapses

Simone Ebert, Thomas Buffet, Semihchan Sermet, Olivier Marre, Bruno Cessac

► To cite this version:

Simone Ebert, Thomas Buffet, Semihchan Sermet, Olivier Marre, Bruno Cessac. Temporal pattern recognition in retinal ganglion cells is mediated by dynamical inhibitory synapses. Neuromod Meeting, Jun 2023, Antibes, France. hal-04351160

HAL Id: hal-04351160

<https://hal.science/hal-04351160>

Submitted on 18 Dec 2023

HAL is a multi-disciplinary open access archive for the deposit and dissemination of scientific research documents, whether they are published or not. The documents may come from teaching and research institutions in France or abroad, or from public or private research centers.

L'archive ouverte pluridisciplinaire **HAL**, est destinée au dépôt et à la diffusion de documents scientifiques de niveau recherche, publiés ou non, émanant des établissements d'enseignement et de recherche français ou étrangers, des laboratoires publics ou privés.

Temporal pattern recognition in retinal ganglion cells is mediated by dynamical inhibitory synapses

Simone Ebert, Thomas Buffet, Semihchan Sermet, Olivier Marre, Bruno Cessac

28.06.2023

Neuromod Meeting 2023

Antibes

Inria



UNIVERSITÉ
CÔTE D'AZUR



Information Processing in the Retina

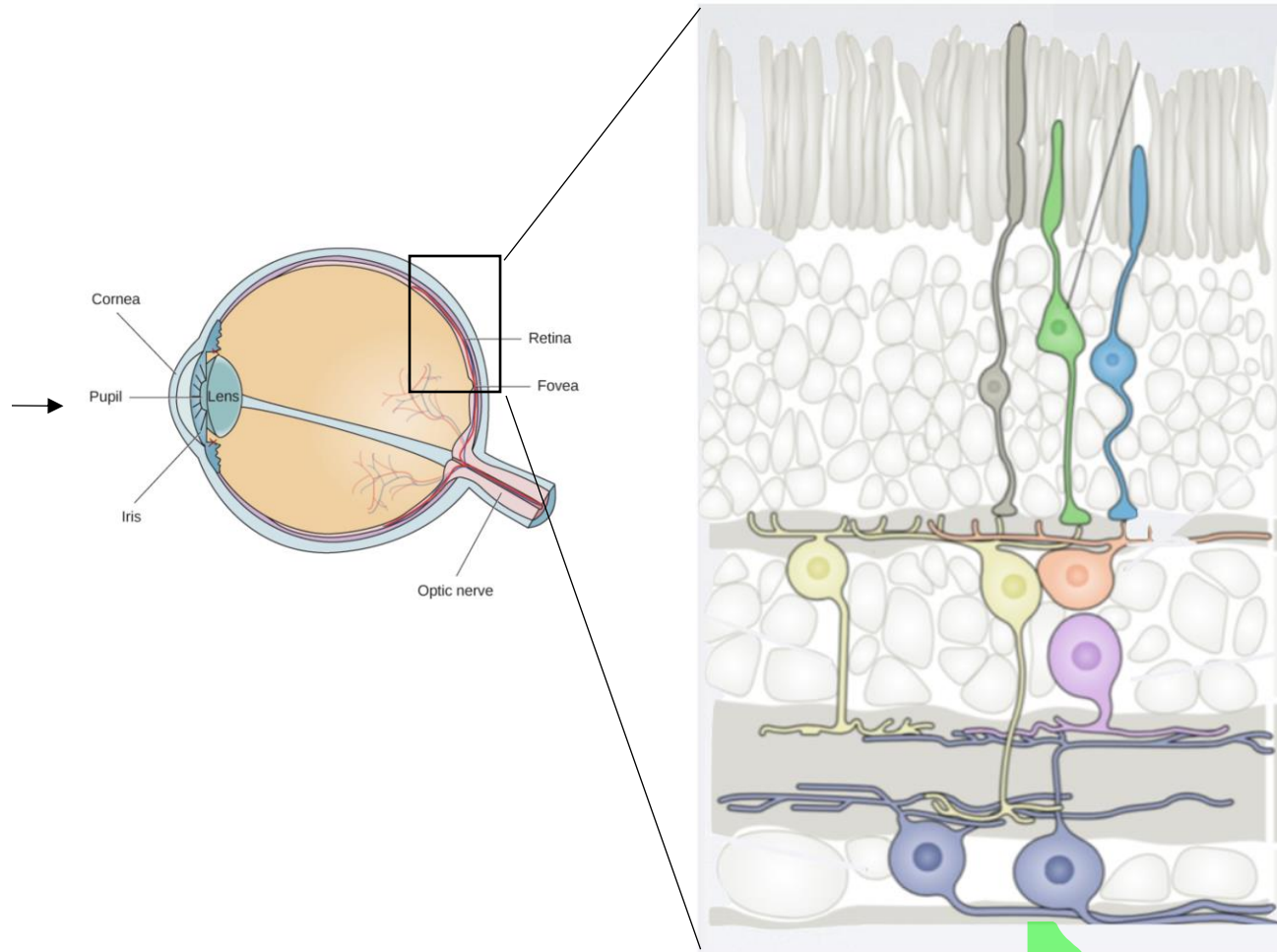

|| || |||

Information Processing in the Retina

- Transforms visual inputs into neuronal responses

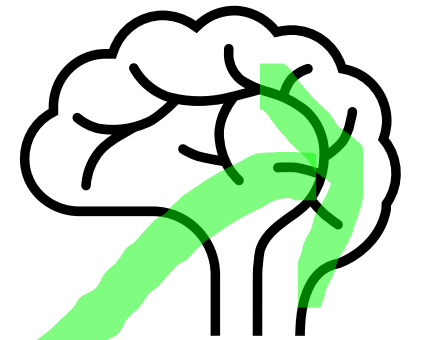
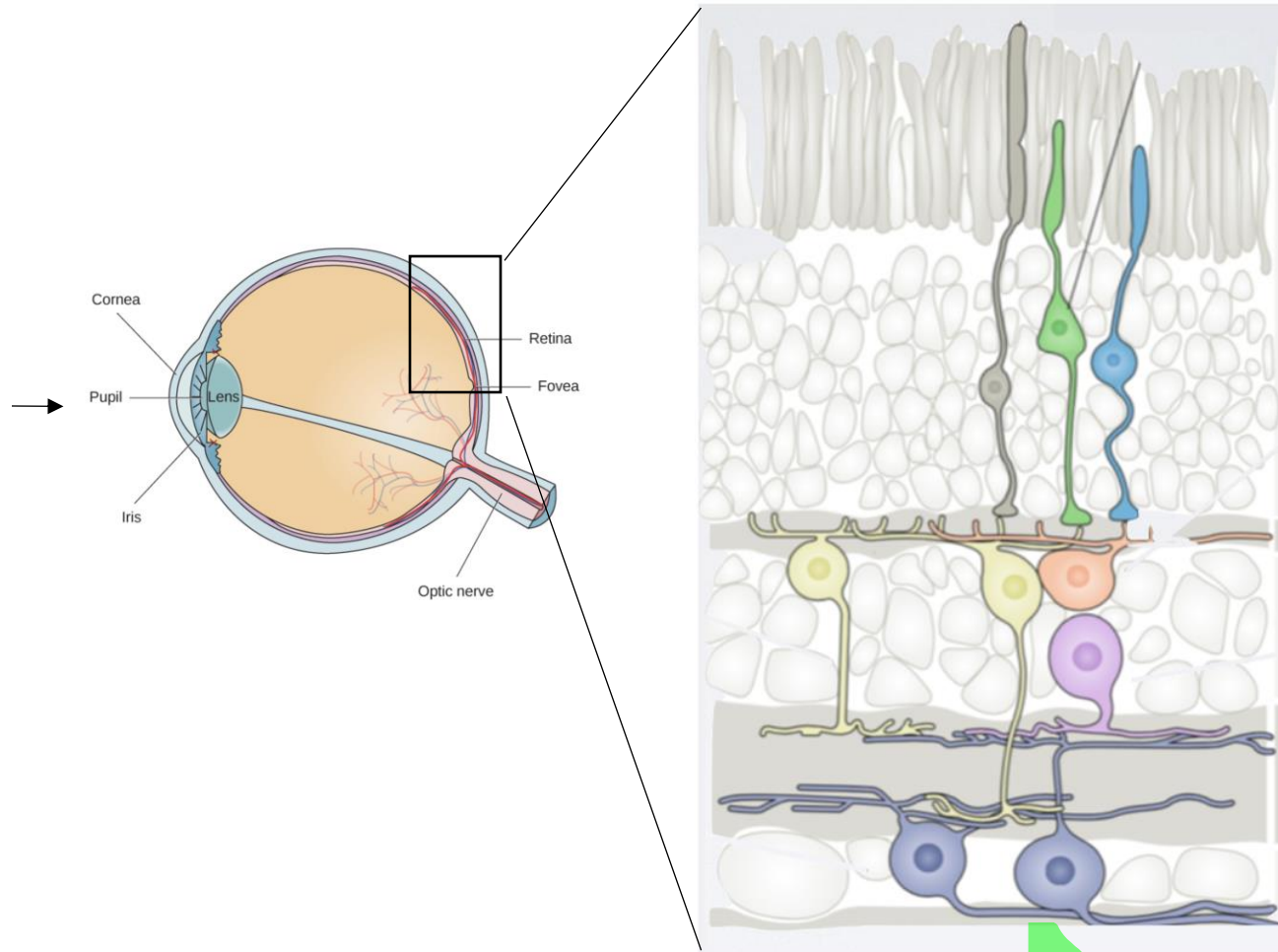

|| || ||

Information Processing in the Retina

- Transforms visual inputs into neuronal responses

- 3 layered network for analog processing visual inputs

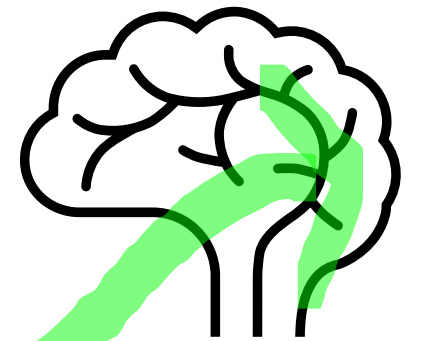
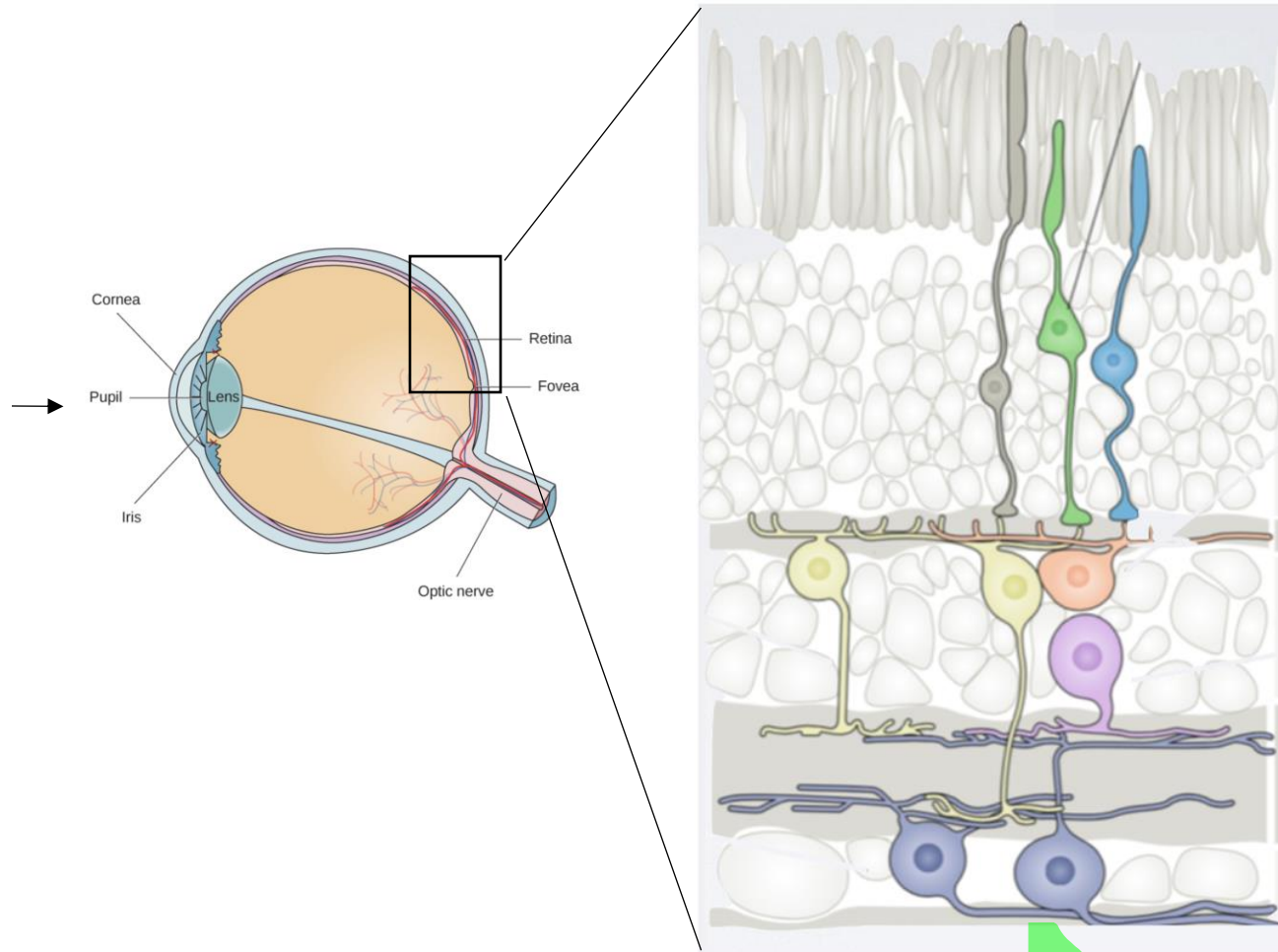

Information Processing in the Retina

- Transforms visual inputs into neuronal responses

- 3 layered network for analog processing visual inputs

- Complex excitatory and inhibitory interactions to facilitate extraction of relevant information

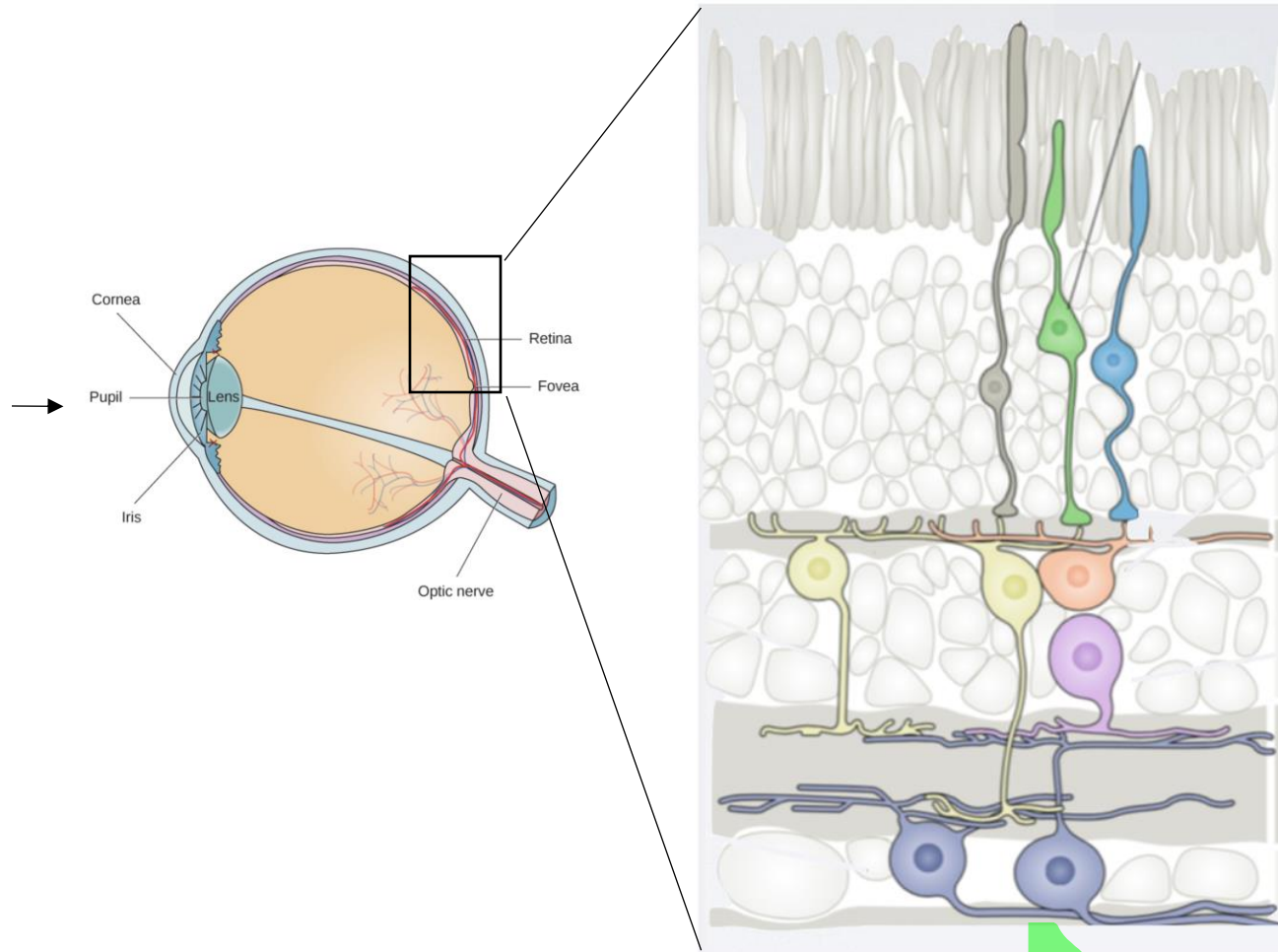

|| || ||

Prediction and Surprise in the Retina

- The retina does not encode the visual scene *per se*

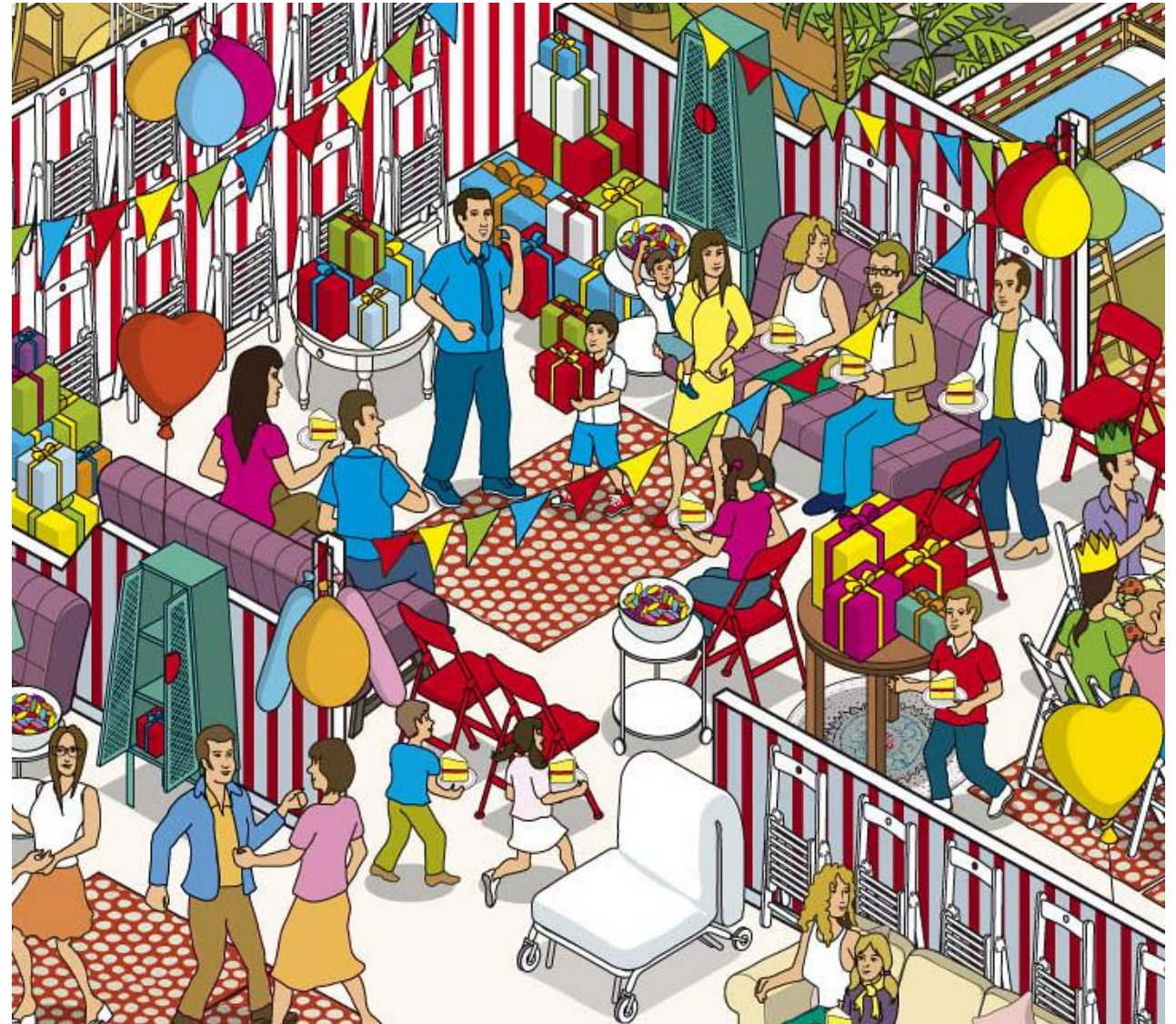

Prediction and Surprise in the Retina

- The retina does not encode the visual scene *per se*
- but forms predictions about future stimuli



Prediction and surprise in the Retina

- The retina does not encode the visual scene *per se*
- but forms predictions about future stimuli
- and signals surprise about unpredicted inputs (= error signal)

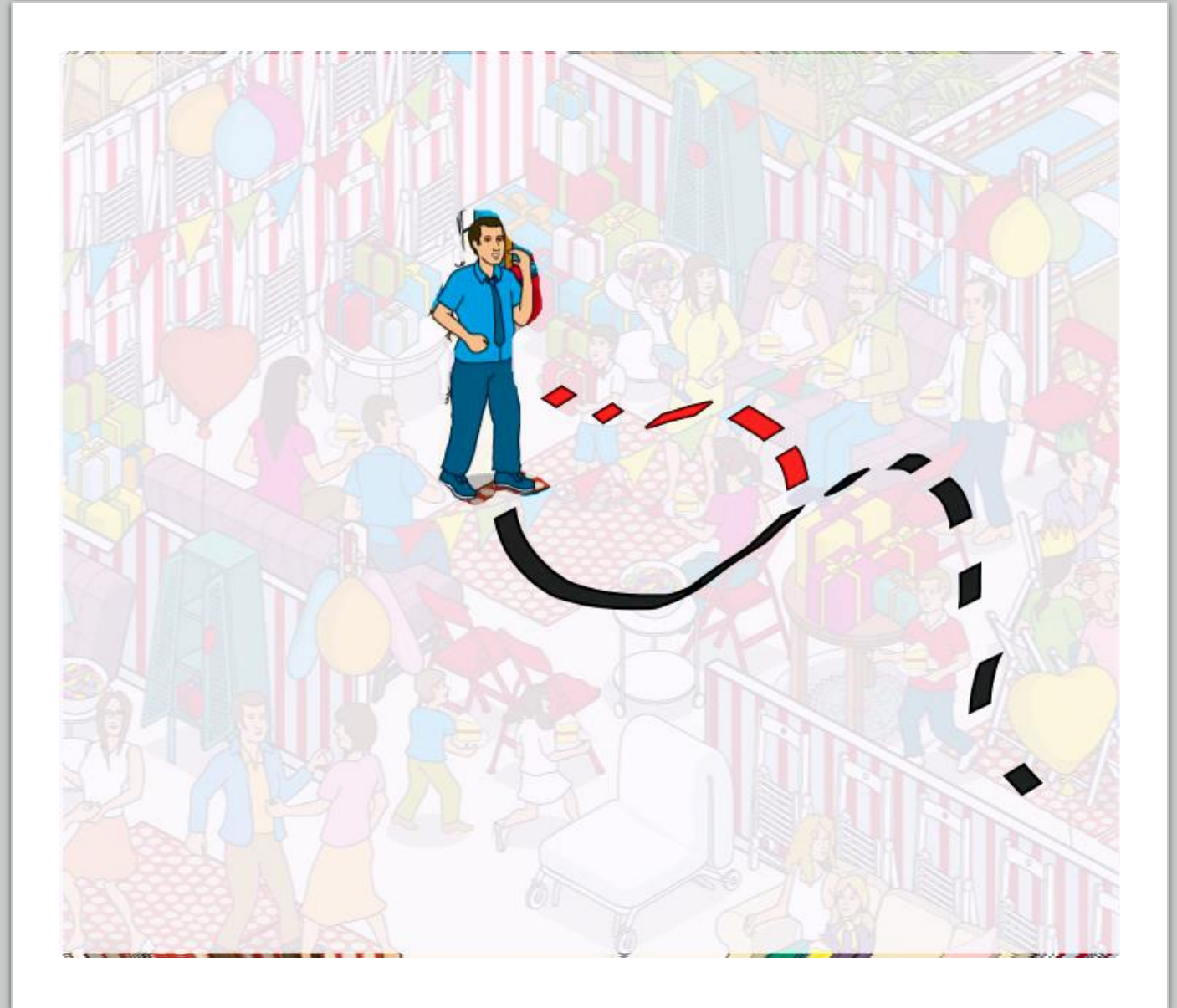

Prediction and surprise in the Retina

- The retina does not just passively receive the visual scene
- but forms predictions about future stimuli
- and signals surprise about unpredicted inputs (= error signal)

How can the retina recognize temporal patterns, form predictions and signal surprise ?

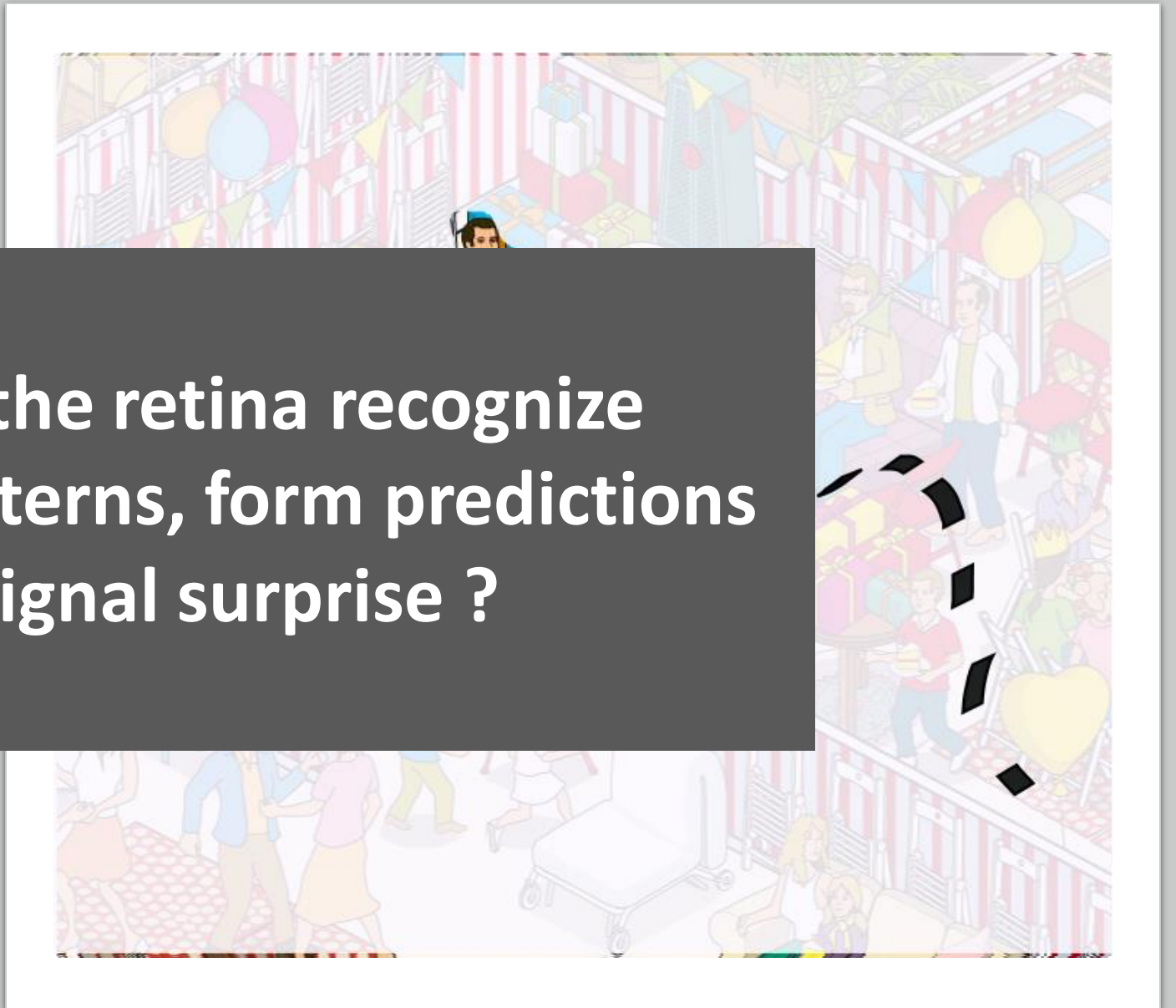

Surprise Response in the Retina

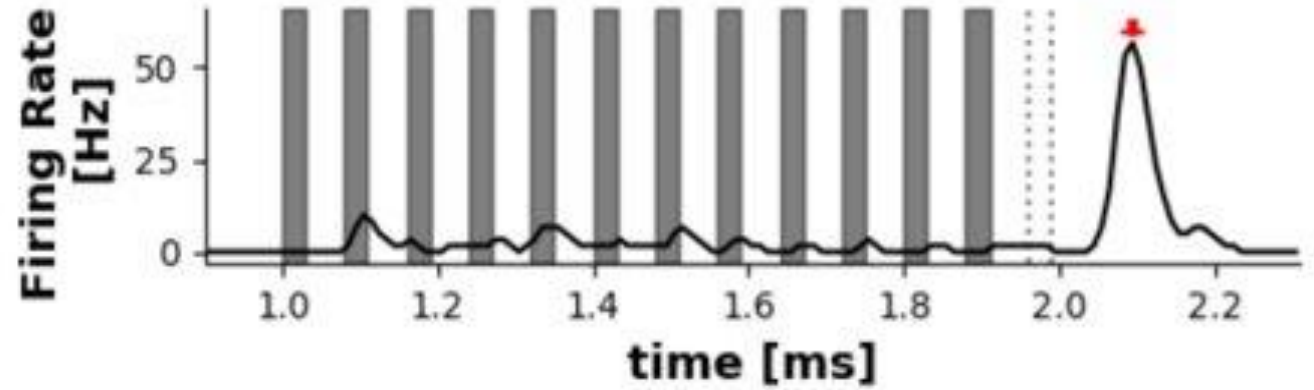
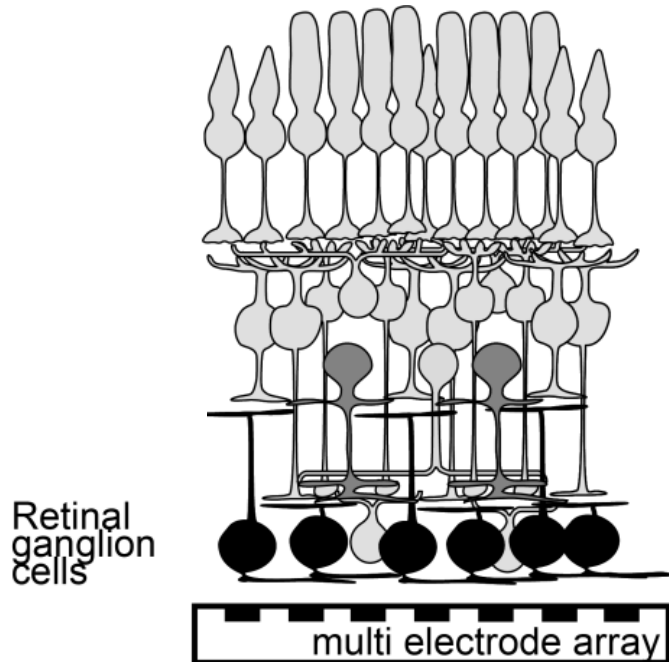

- periodic flash sequence
- omitted flash
- ↓ pulse of activity signaling the missing stimulus

first observed by Schwartz et al, 2007

Surprise Response in the Retina

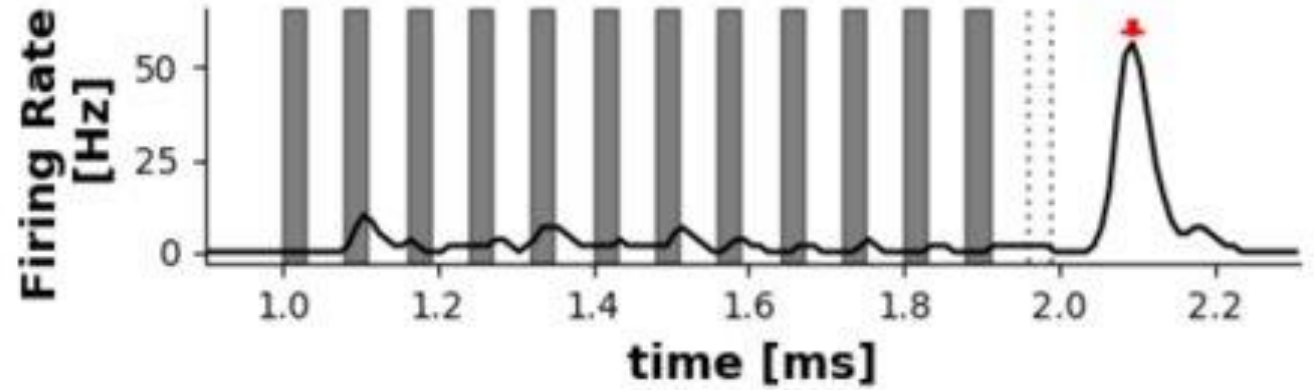
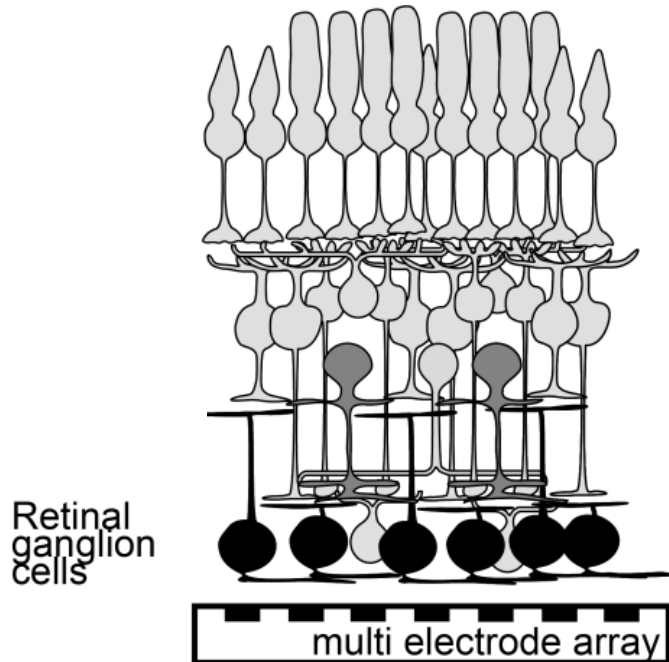

- periodic flash sequence
- omitted flash
- ↓ pulse of activity signaling the missing stimulus



The retina emits an **Omitted Stimulus Response** when an expected stimulus in a periodic sequence is missing.

first observed by Schwartz et al, 2007

Response latency shifts with stimulus period

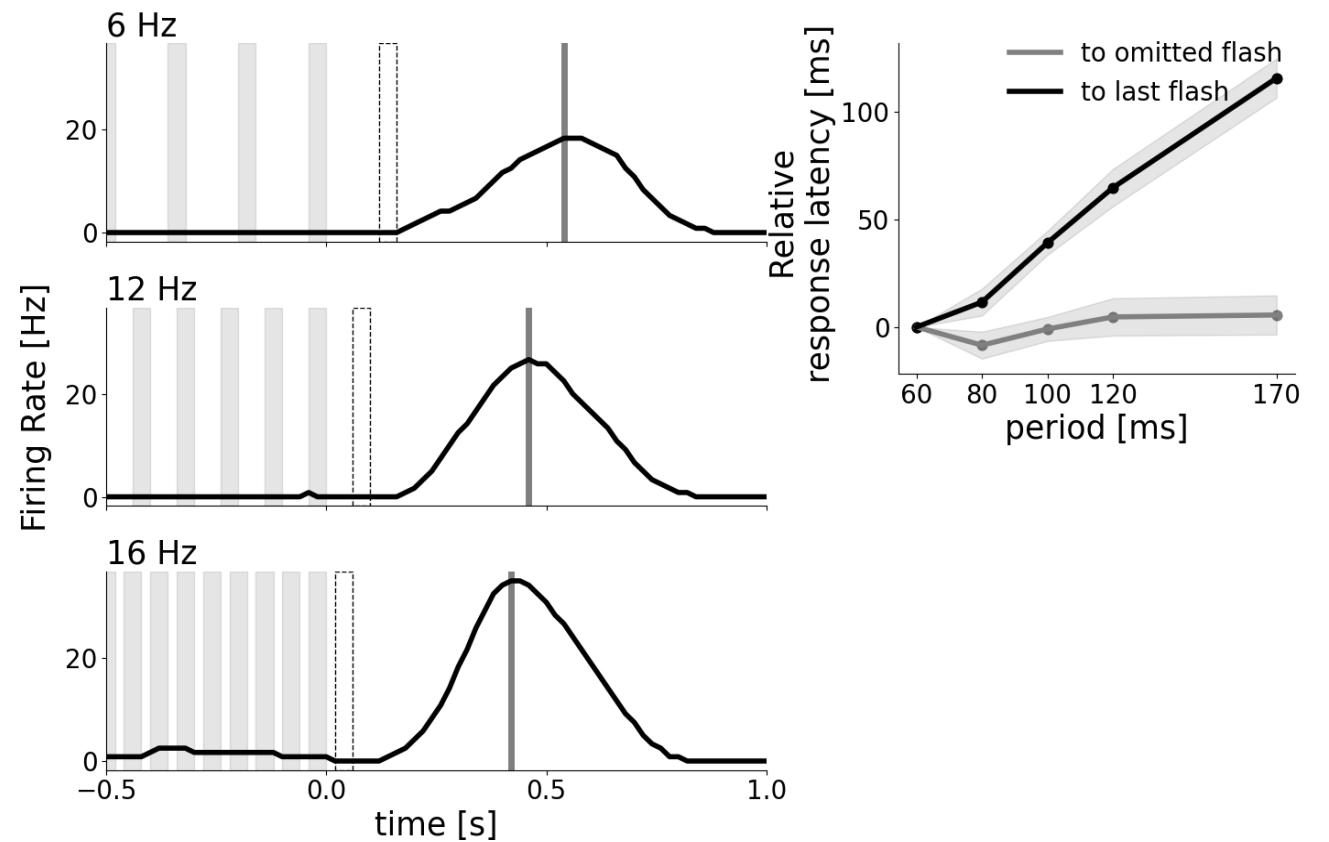
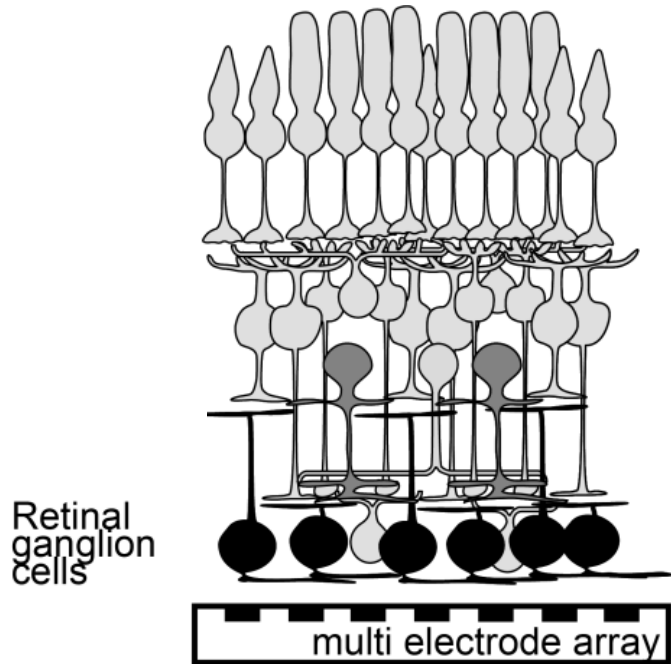

first observed by Schwartz et al, 2007

Response latency shifts with stimulus period

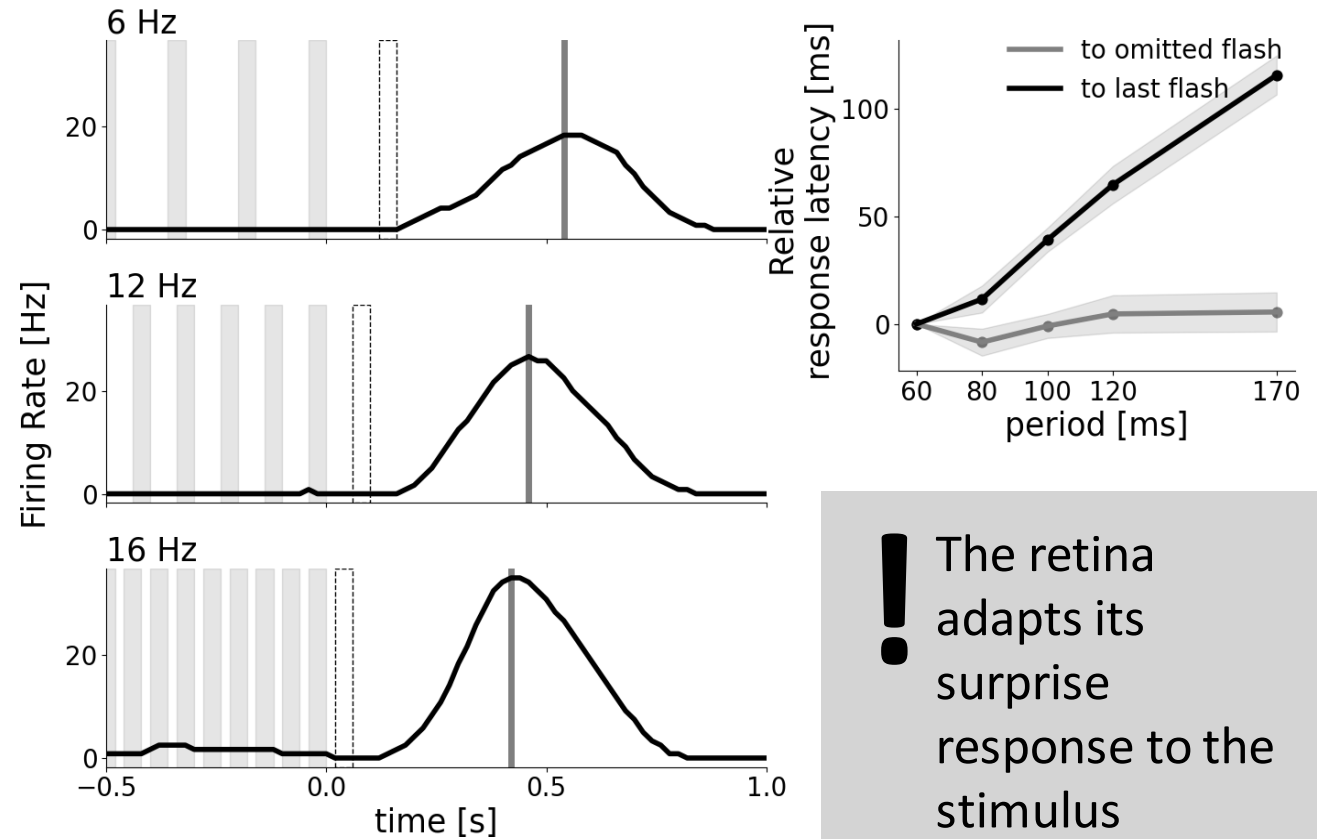
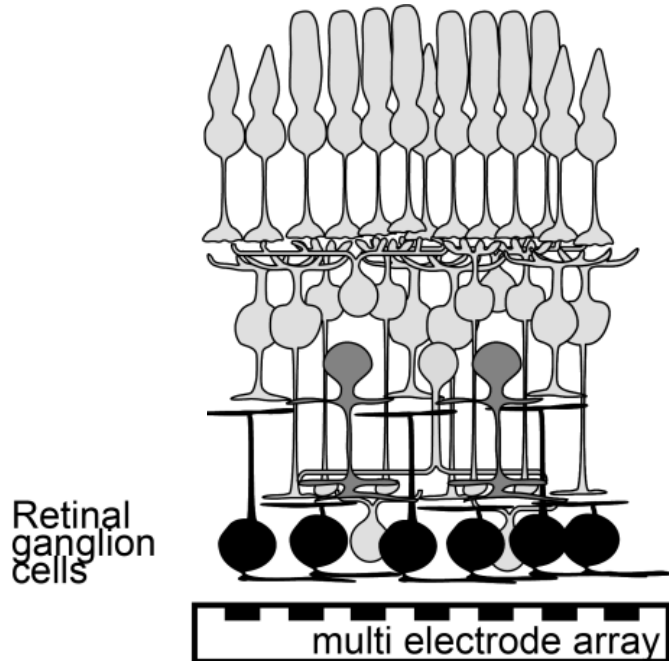

! The retina adapts its surprise response to the stimulus

first observed by Schwartz et al, 2007

Inhibition is necessary for latency scaling

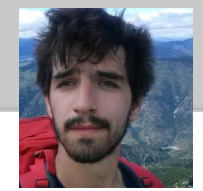
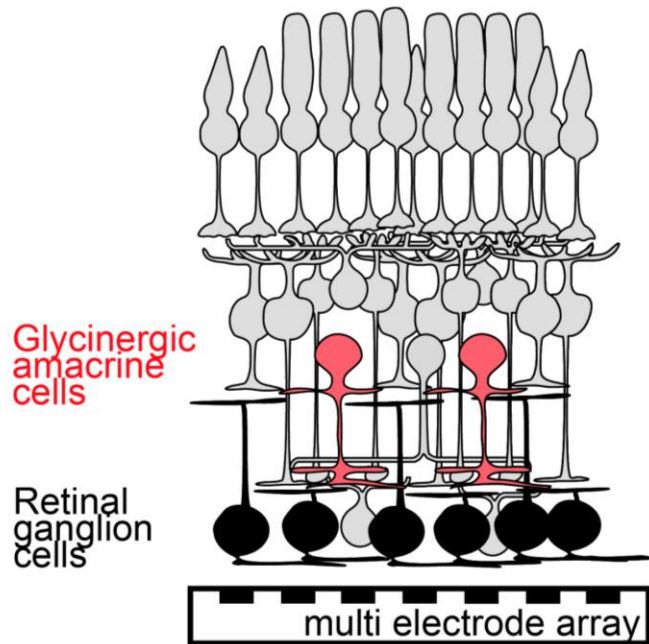

Thomas Buffet

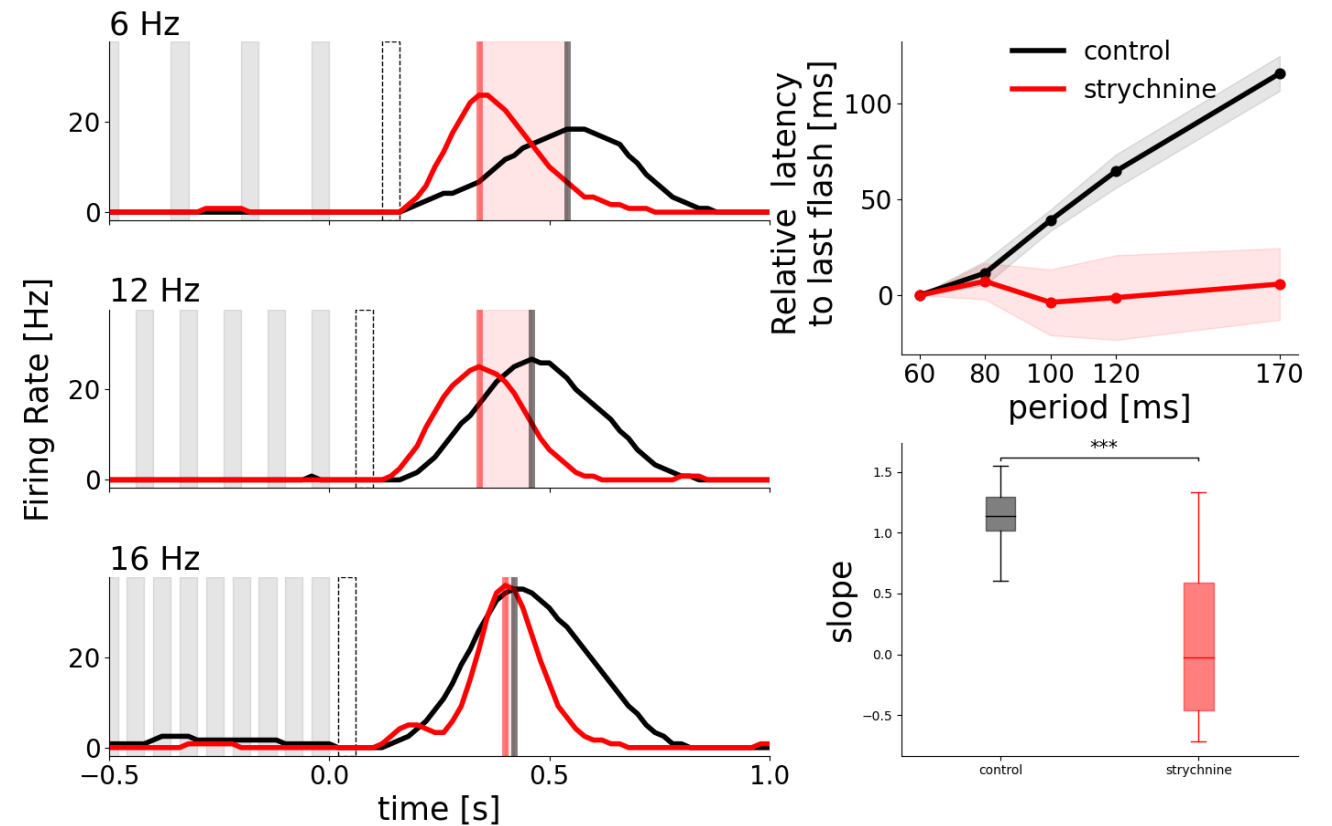

Dynamic Network Model of the Retina

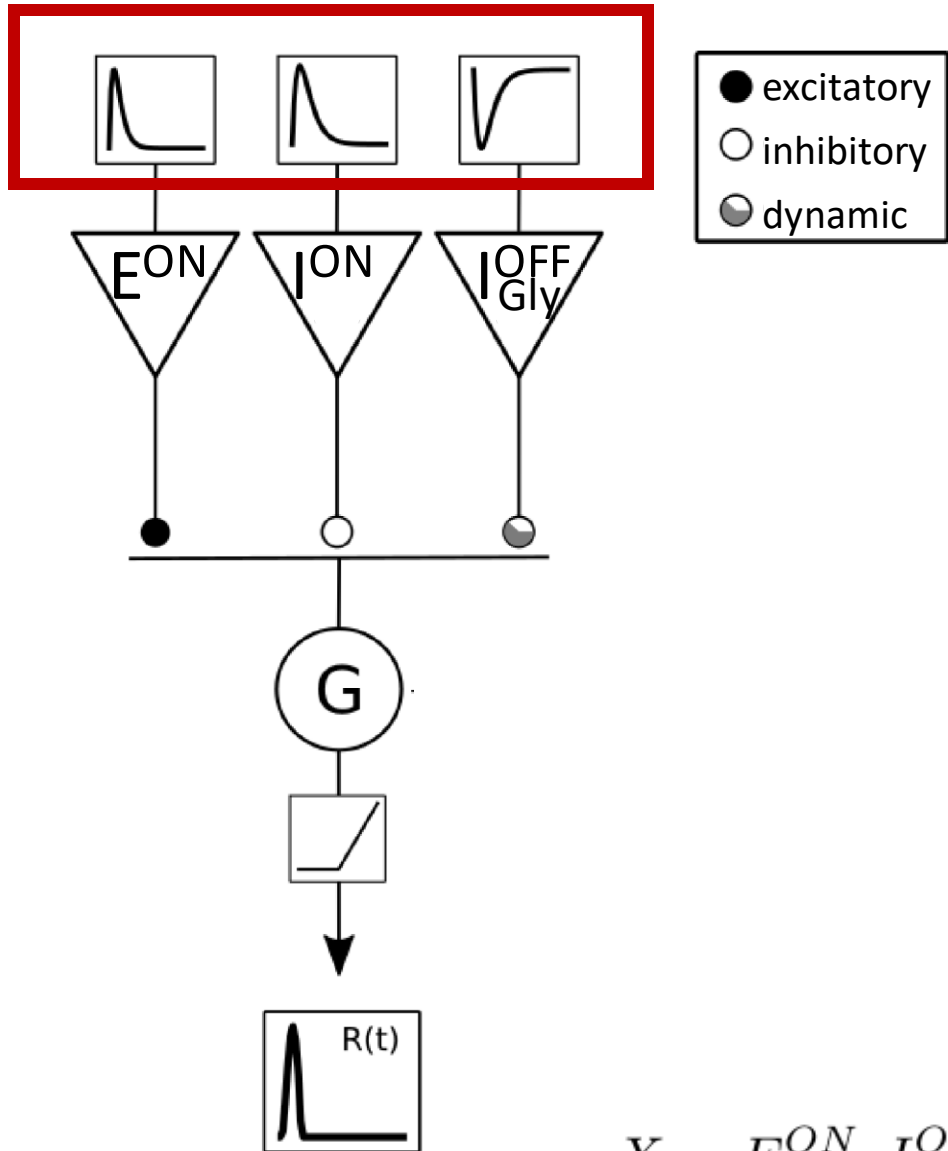

1. Convolution of stimulus and temporal kernel

$$F_X(t) = S_X[\alpha_X * s](t)$$

$$X = E^{ON}, I^{ON}, I_{Gly}^{OFF}$$

Dynamic Network Model of the Retina

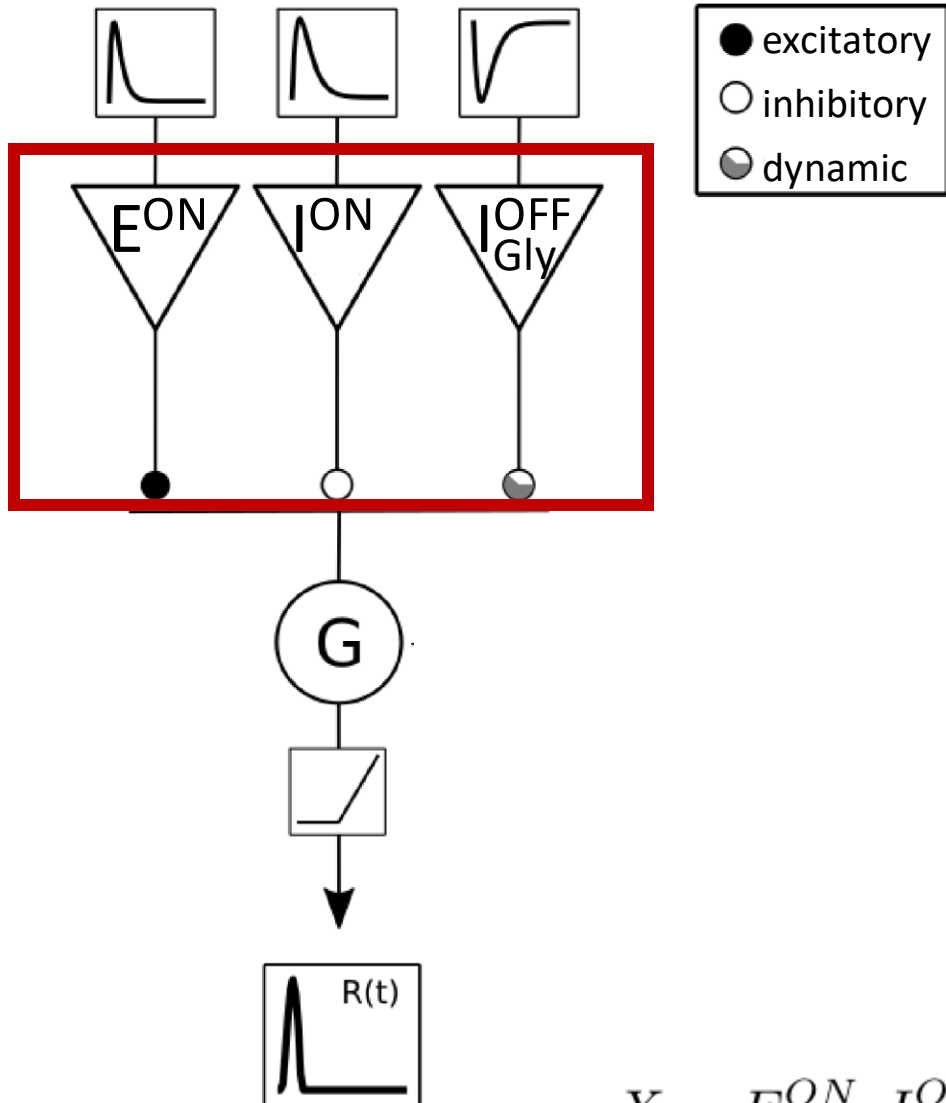

1. Convolution of stimulus and temporal kernel

$$F_X(t) = S_X[\alpha_X * s](t)$$

2. Intermediate units integrate the signal

$$\frac{dV_X}{dt} = -\frac{V_X}{\tau_X} + F_X(t)$$

Dynamic Network Model of the Retina

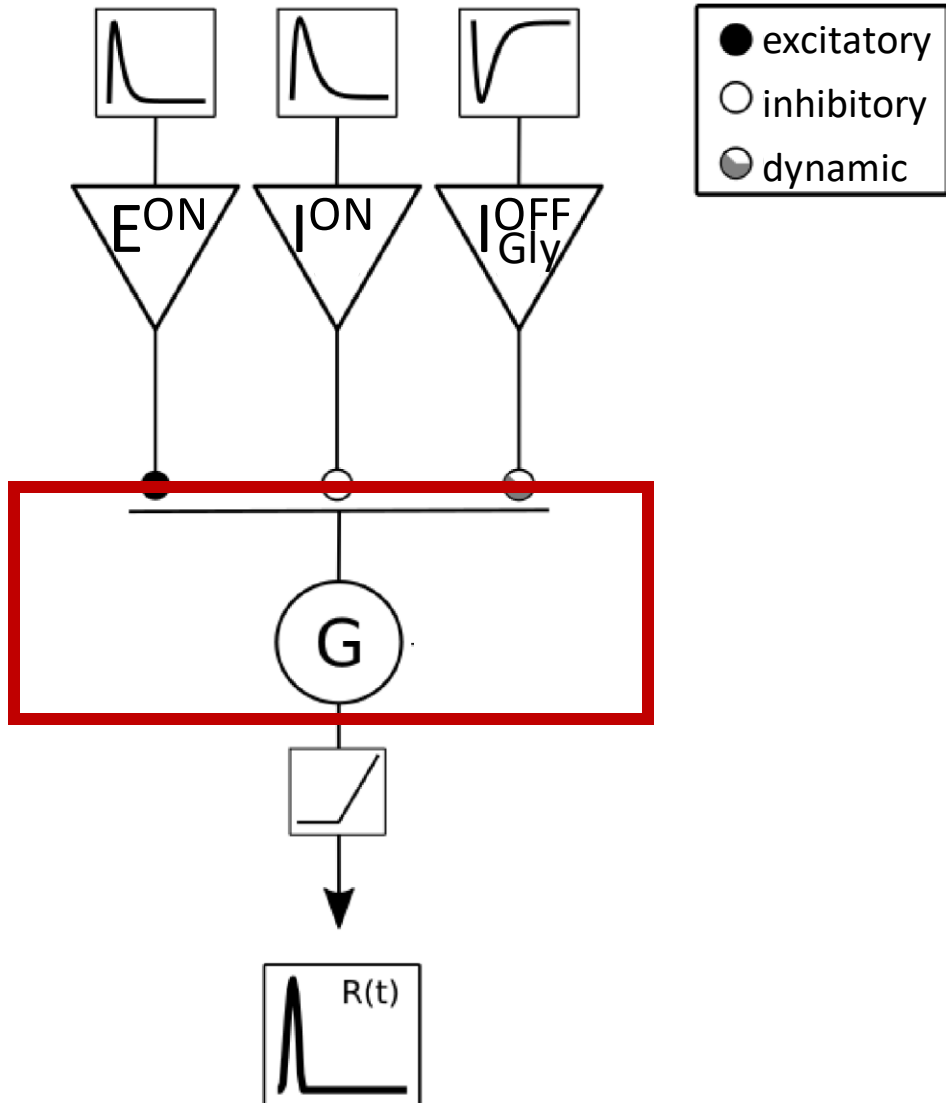

1. Convolution of stimulus and temporal kernel

$$F_X(t) = S_X[\alpha_X * s](t)$$

2. Intermediate units integrate the signal

$$\frac{dV_X}{dt} = -\frac{V_X}{\tau_X} + F_X(t)$$

3. RGCs pool over network

$$\frac{dV_G}{dt} = -\frac{V_G}{\tau_G} + \sum_{X=1}^N w_X p(V_X(t), \theta_X)$$

Dynamic Network Model of the Retina

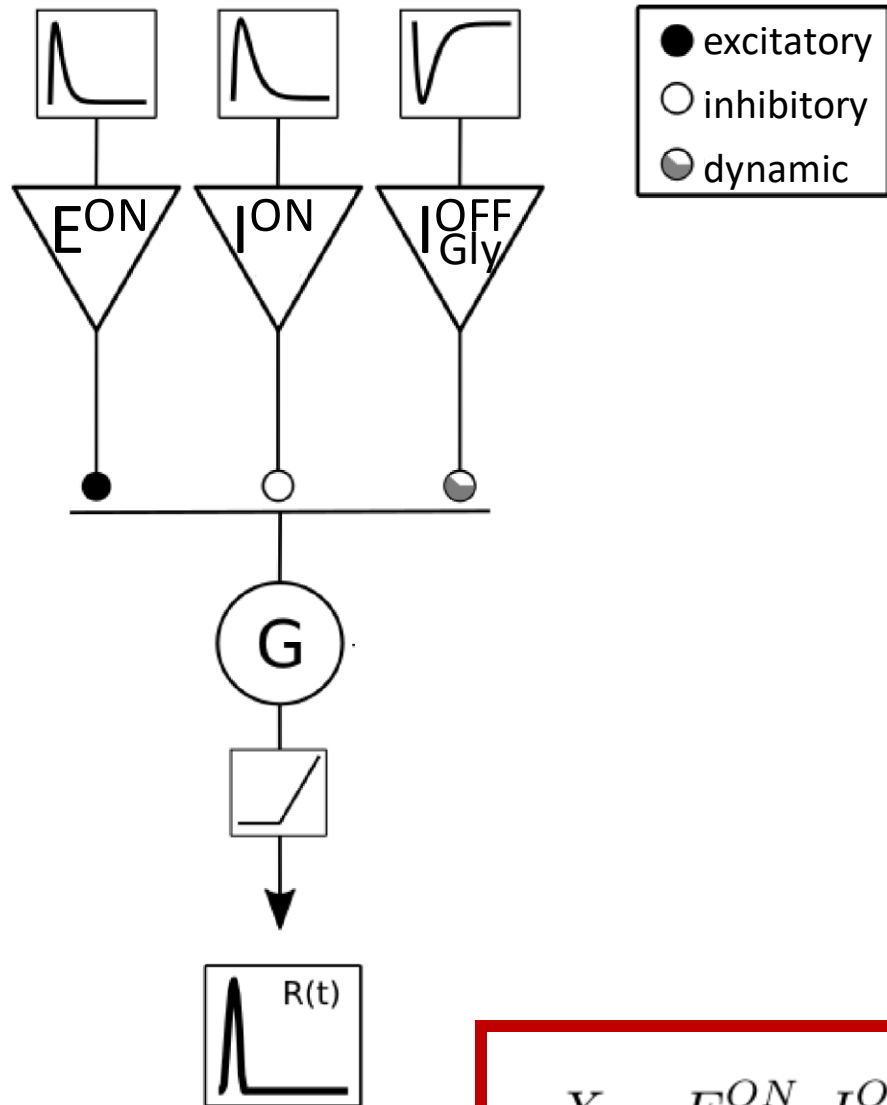

1. Convolution of stimulus and temporal kernel

$$F_X(t) = S_X[\alpha_X * s](t)$$

2. Intermediate units integrate the signal

$$\frac{dV_X}{dt} = -\frac{V_X}{\tau_X} + F_X(t)$$

3. RGCs pool over network

$$\frac{dV_G}{dt} = -\frac{V_G}{\tau_G} + \sum_{X=1}^N w_X p(V_X(t), \theta_X)$$

$$X = E^{ON}, I^{ON}, I_{Gly}^{OFF}$$

Dynamic Network Model of the Retina

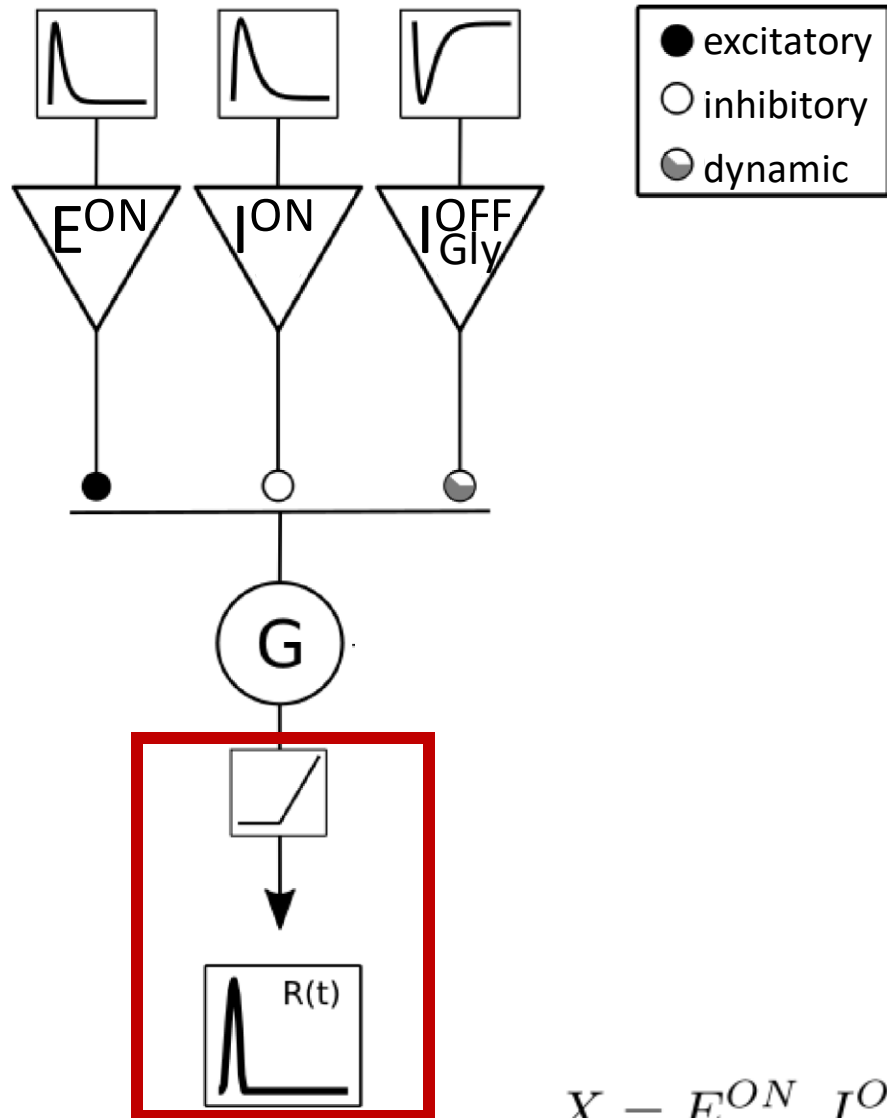

1. Convolution of stimulus and temporal kernel

$$F_X(t) = S_X[\alpha_X * s](t)$$

2. Intermediate units integrate the signal

$$\frac{dV_X}{dt} = -\frac{V_X}{\tau_X} + F_X(t)$$

3. RGCs pool over network

$$\frac{dV_G}{dt} = -\frac{V_G}{\tau_G} + \sum_{X=1}^N w_X p(V_X(t), \theta_X)$$

Input-dependent Adaptive Coupling via Short-term Depression

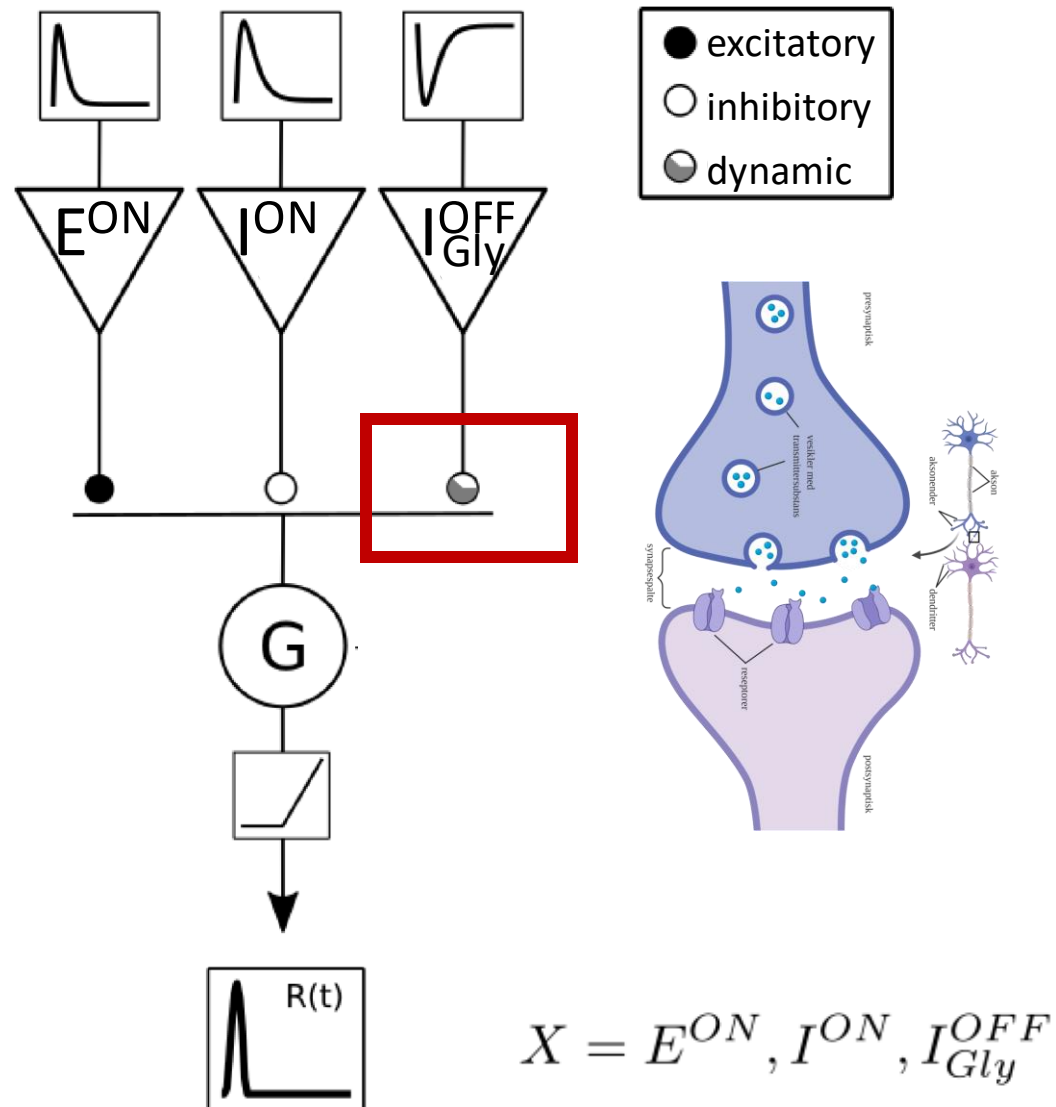

1. The variable n adapts dynamically to the input

$$\frac{dn}{dt} = (1 - n)k_{rec} - \beta k_{rel} p(V_{I_{Gly}^{OFF}}, \theta_{I_{gly}^{OFF}}) n$$

Input-dependent Adaptive Coupling via Short-term Depression

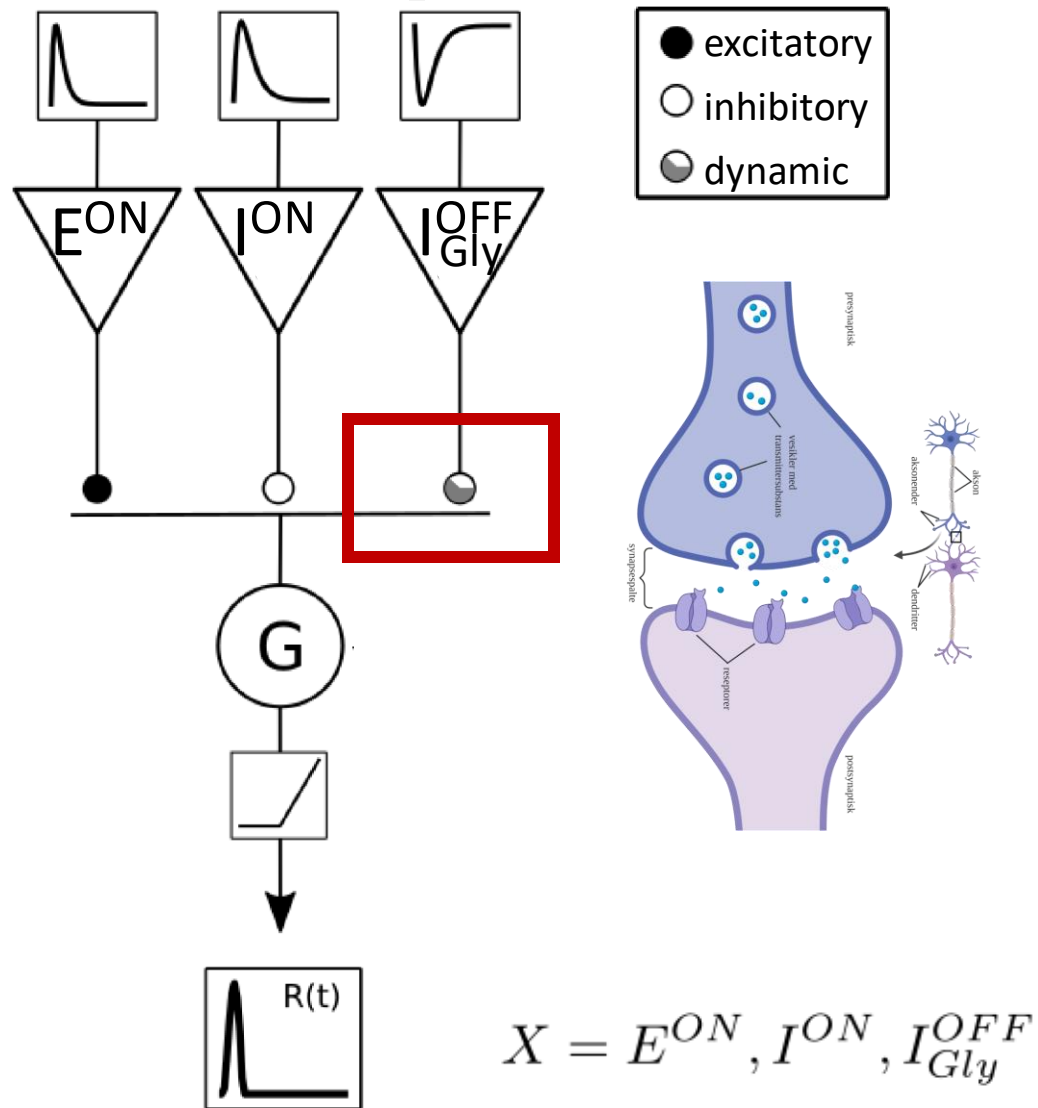

1. The variable n adapts dynamically to the input

$$\frac{dn}{dt} = (1 - n)k_{rec} - \beta k_{rel} p(V_{I_{Gly}^{OFF}}, \theta_{I_{gly}^{OFF}}) n$$

2. The synaptic weight is scales by n

$$w(t) = \bar{w} n(t)$$

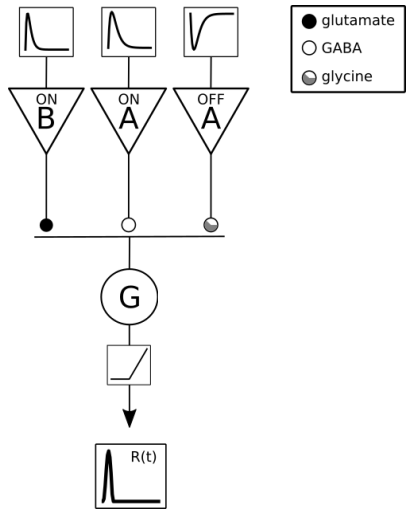

Model

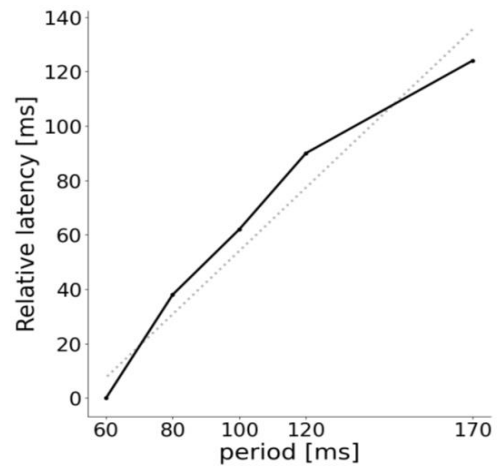
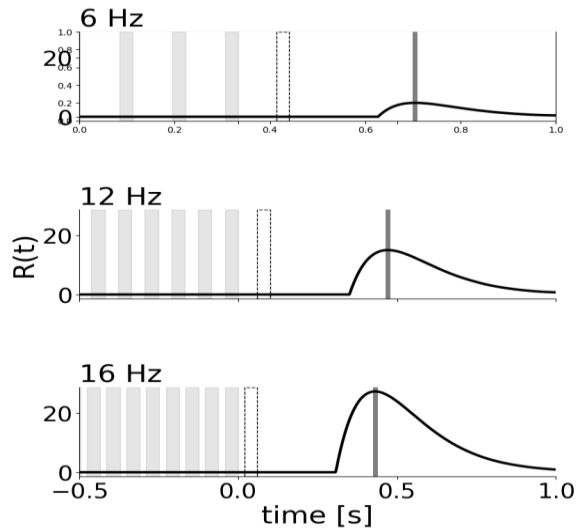

Experiments

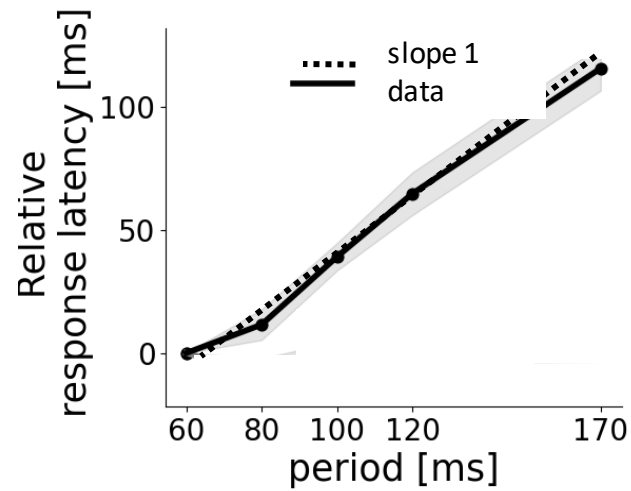
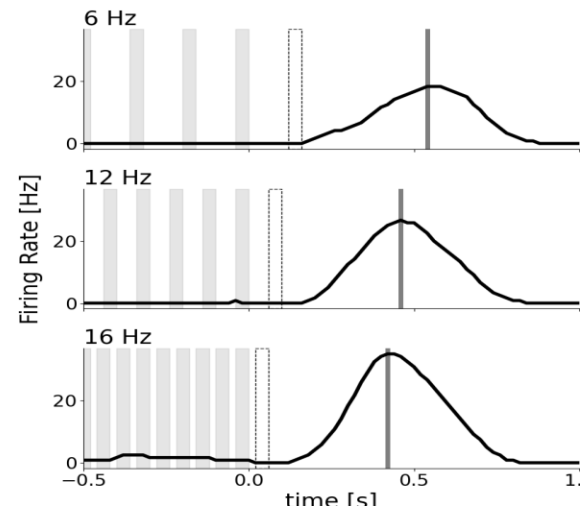

Retinal ganglion cells

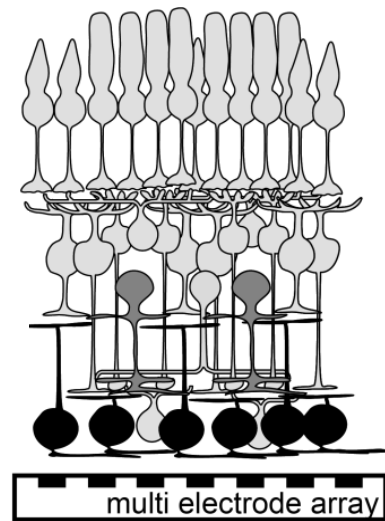

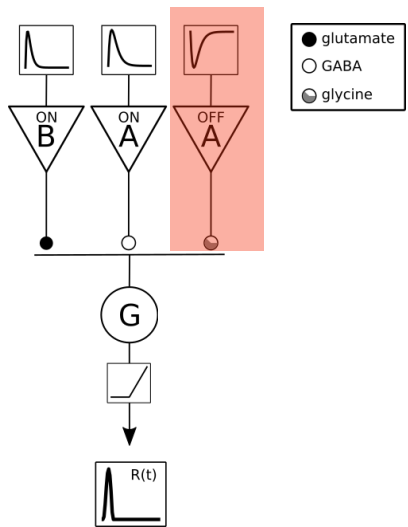

Model

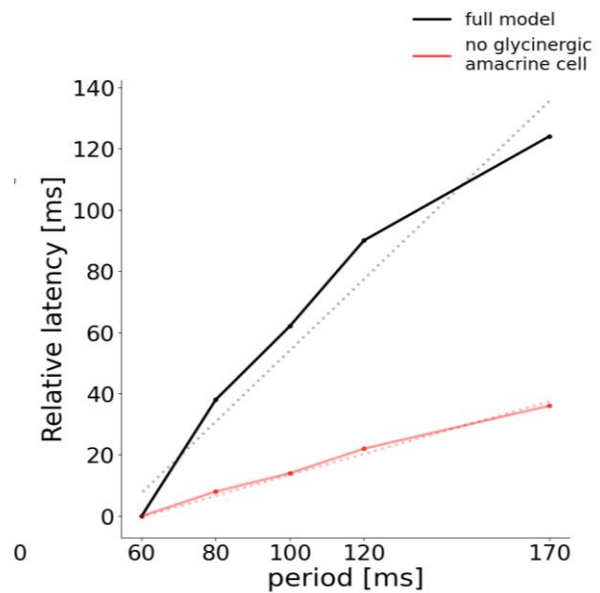
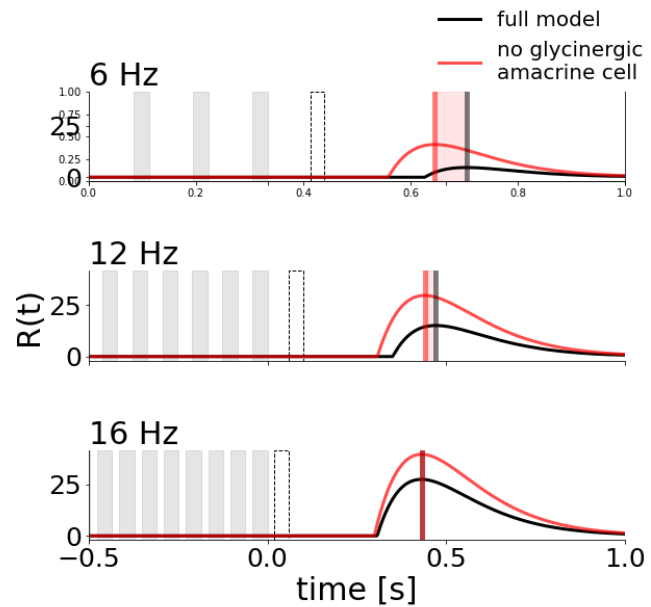

Experiments

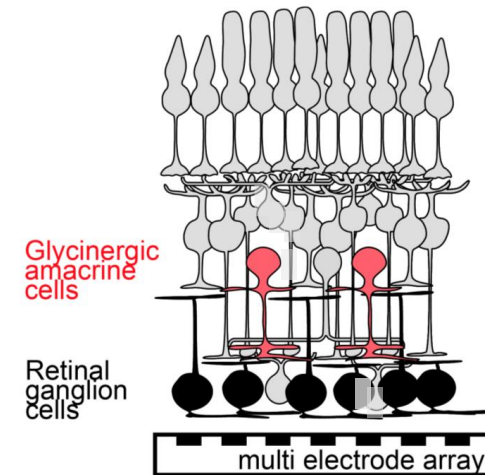
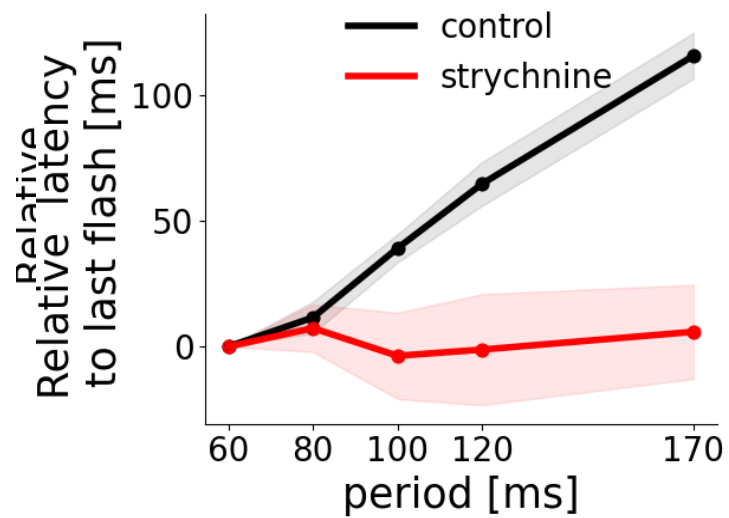
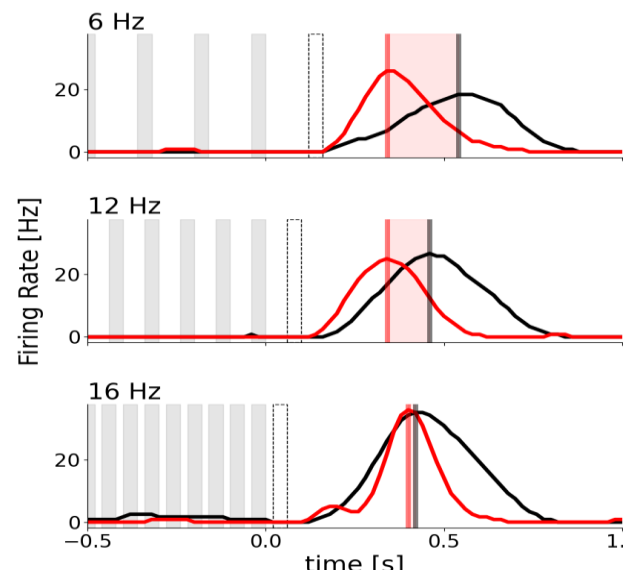

Model produces **error signal** via excitation and slower inhibition

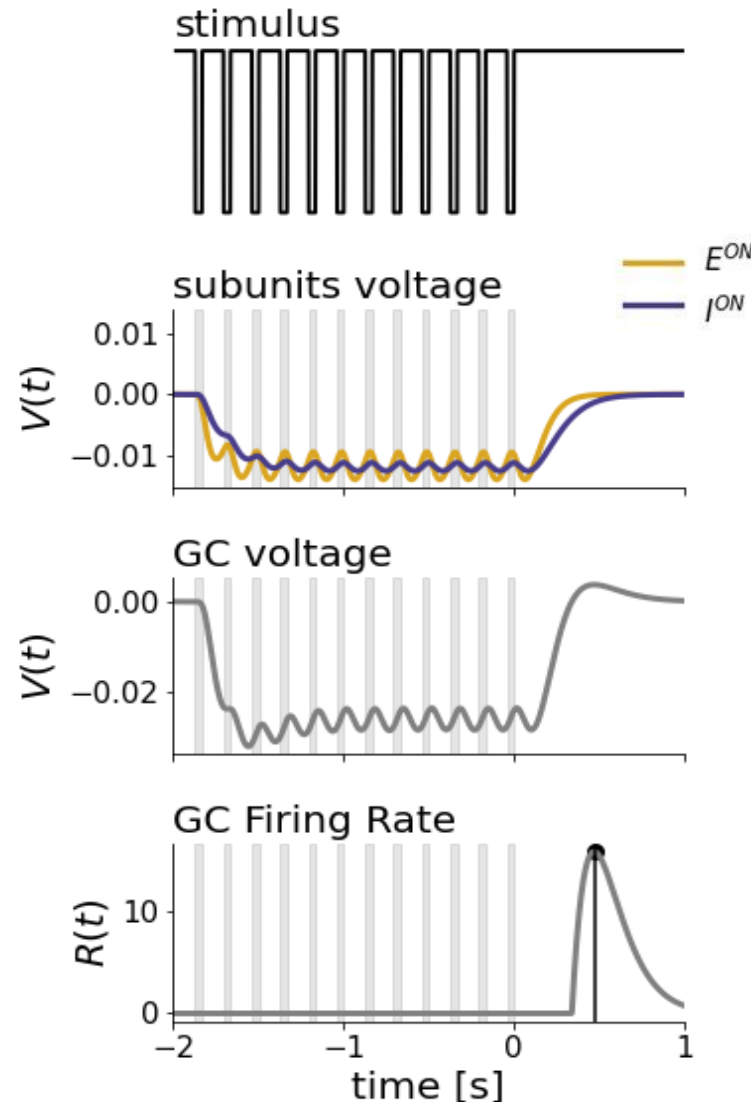

$$\frac{dV_G}{dt} = -\frac{V_G}{\tau_G} + w_{EON} V_{EON} + nw_{I_{Gly}^{OFF}} p(V_{I_{Gly}^{OFF}}, \theta_{I_{Gly}^{OFF}}) + w_{ION} V_{ION}$$

Model produces **error signal** via excitation and slower inhibition

Additional inhibition **shifts the latency**

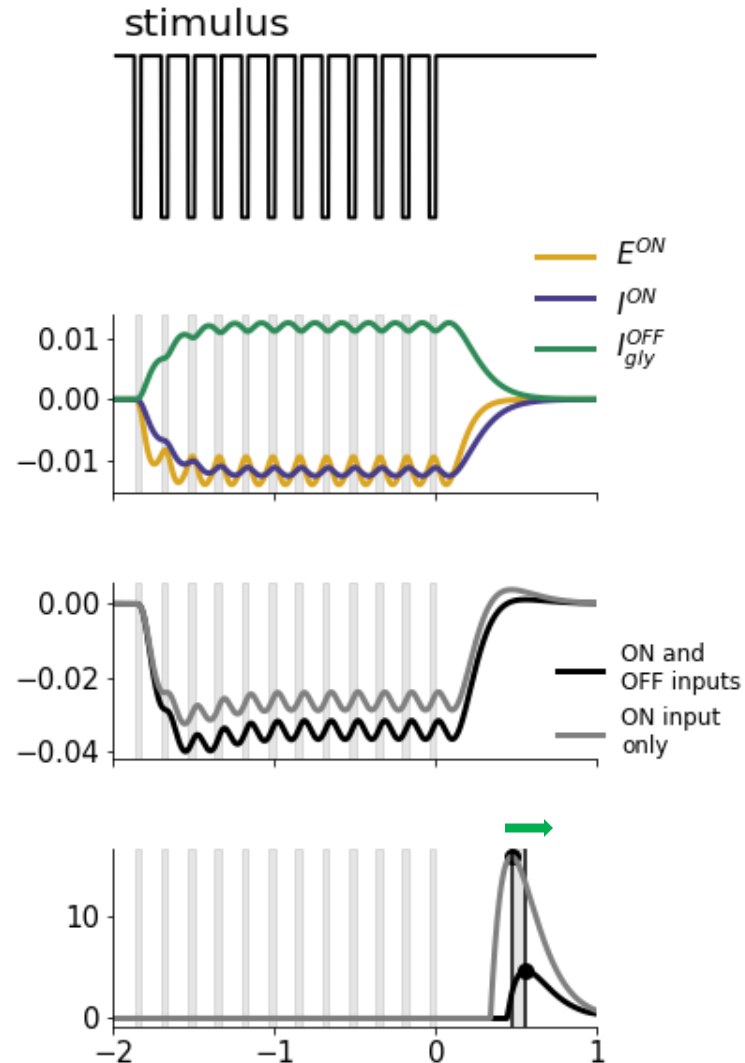

$$\frac{dV_G}{dt} = -\frac{V_G}{\tau_G} + w_{EON} V_{EON} + nw_{I_{Gly}^{OFF}} p(V_{I_{Gly}^{OFF}}, \theta_{I_{Gly}^{OFF}}) + w_{ION} V_{ION}$$

Model produces **error signal** via excitation and slower inhibition

Additional inhibition **shifts the latency**

Plasticity scales latency **shift to frequency**

$$\frac{dn}{dt} = (1 - n)k_{rec} - \beta k_{rel} p(V_{I_{Gly}^{OFF}}, \theta_{I_{gly}^{OFF}}) n$$

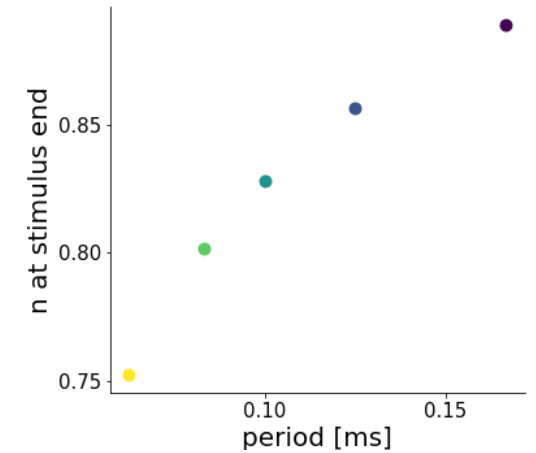
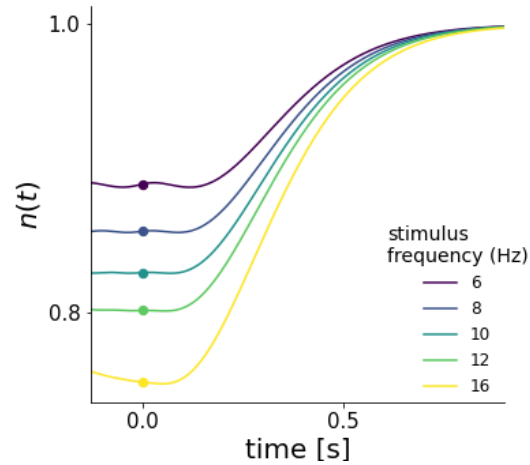
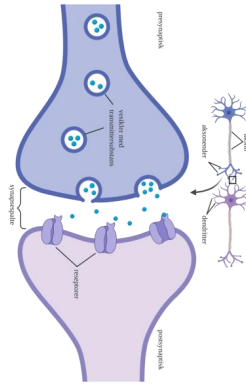

$$\frac{dV_G}{dt} = -\frac{V_G}{\tau_G} + w_{EON} V_{EON} + n w_{I_{Gly}^{OFF}} p(V_{I_{Gly}^{OFF}}, \theta_{I_{gly}^{OFF}}) + w_{ION} V_{ION}$$

Model produces **error signal** via excitation and slower inhibition

Additional inhibition **shifts the latency**

Plasticity scales latency **shift to frequency**

$$\frac{dn}{dt} = (1 - n)k_{rec} - \beta k_{rel} p(V_{I_{Gly}^{OFF}}, \theta_{I_{gly}^{OFF}}) n$$

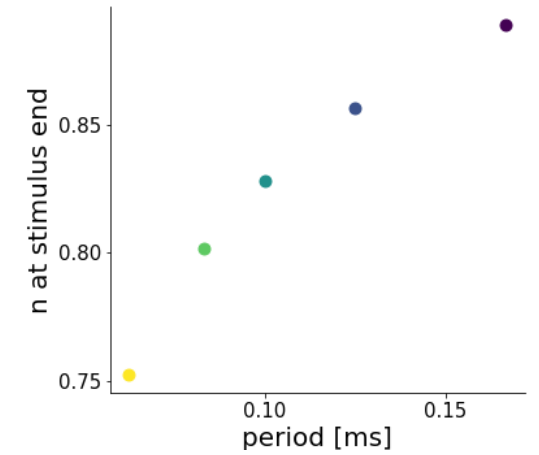
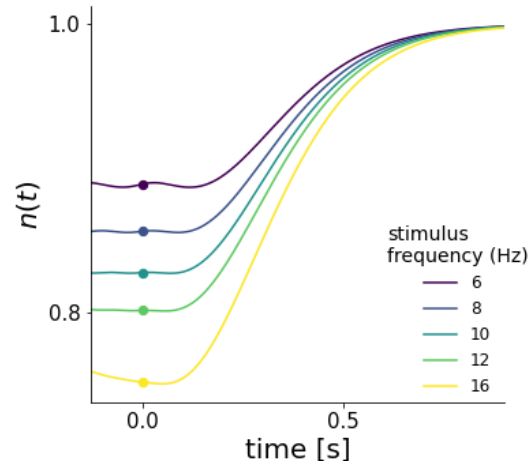
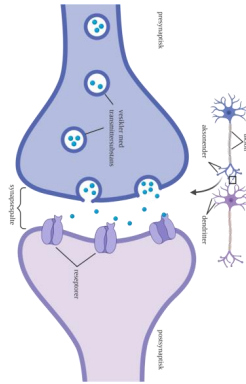

$$\frac{dV_G}{dt} = -\frac{V_G}{\tau_G} + w_{EON} V_{EON} + n w_{I_{Gly}^{OFF}} p(V_{I_{Gly}^{OFF}}, \theta_{I_{Gly}^{OFF}}) + w_{ION} V_{ION}$$

Conclusion

- Retina forms **predictions** about its future inputs and signals **surprise** when they are violated



Conclusion

- Retina forms **predictions** about its future inputs and signals **surprise** when they are violated
- We show how this may be implemented via excitatory-inhibitory interactions
- temporal precision arises from **dynamic synaptic adaptation**

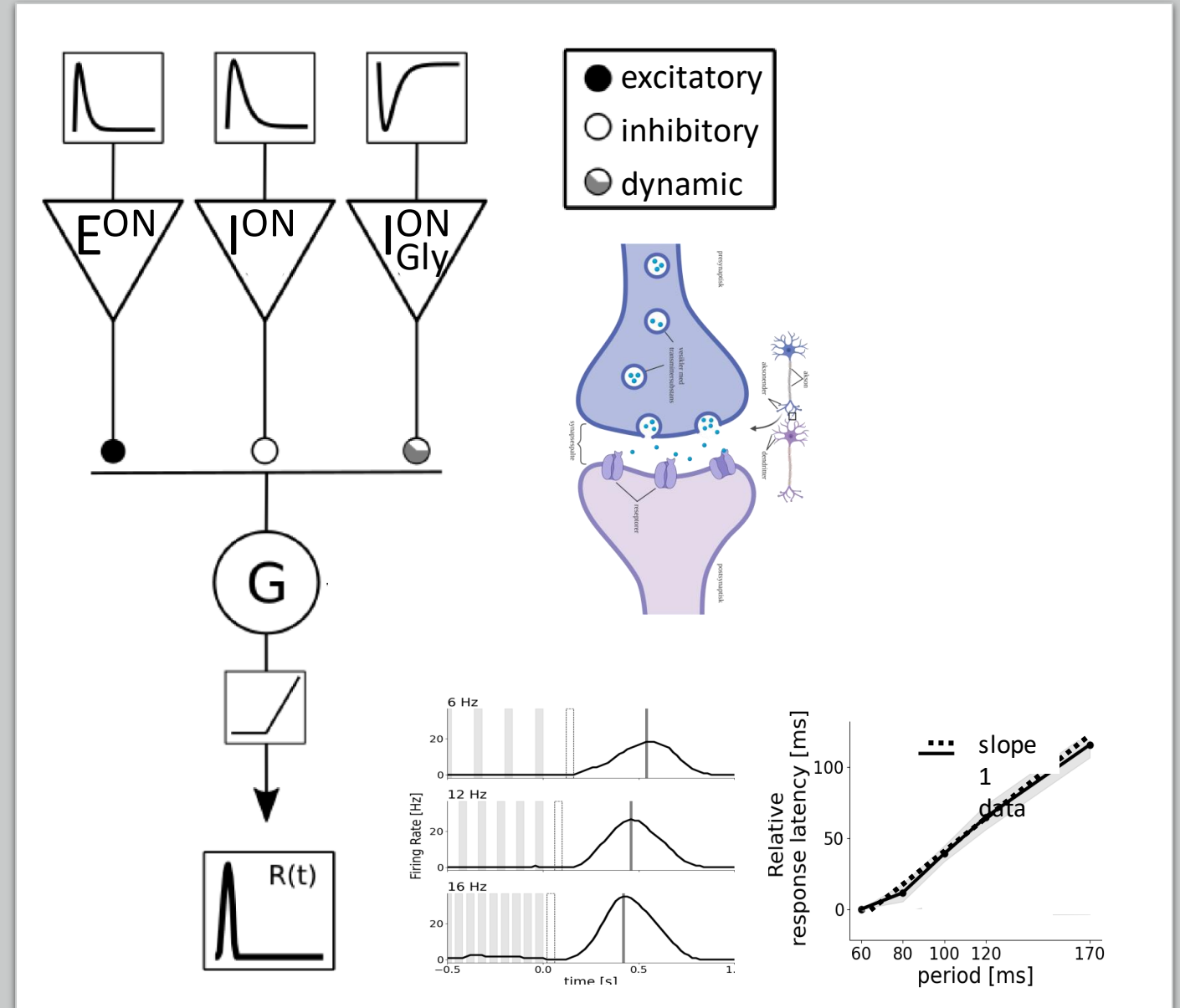

Outlook

- **Anticipation of motion trajectories**

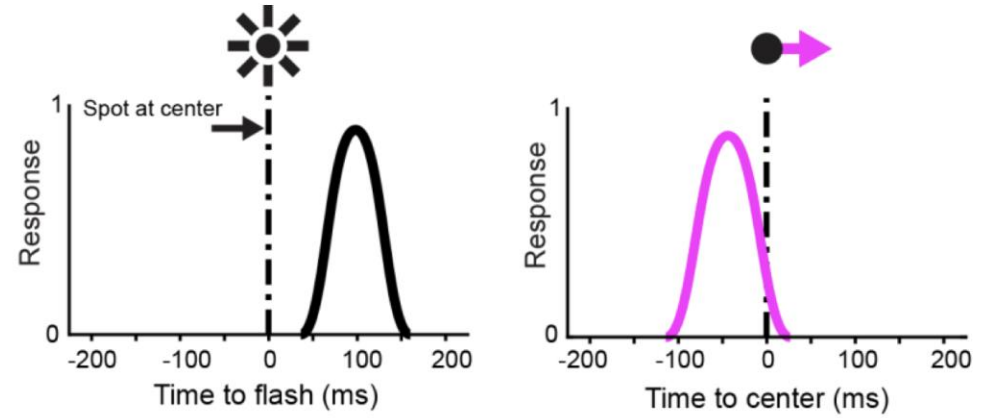

Outlook

- **Anticipation of motion trajectories** via inhibitory network

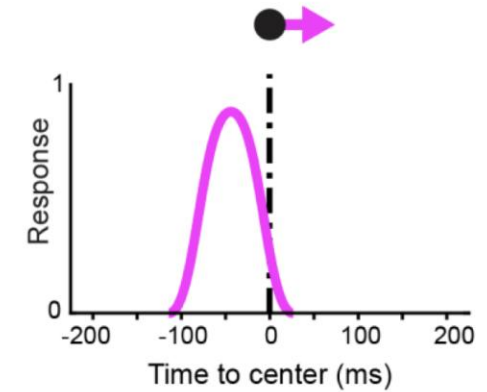
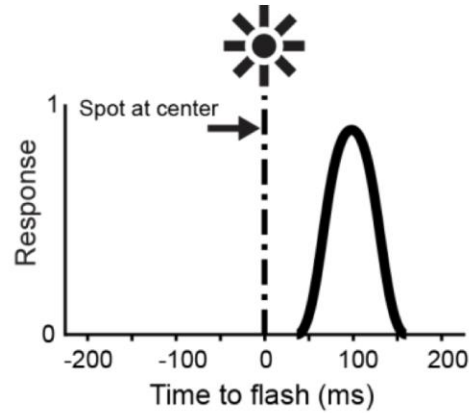

Selma Souihel

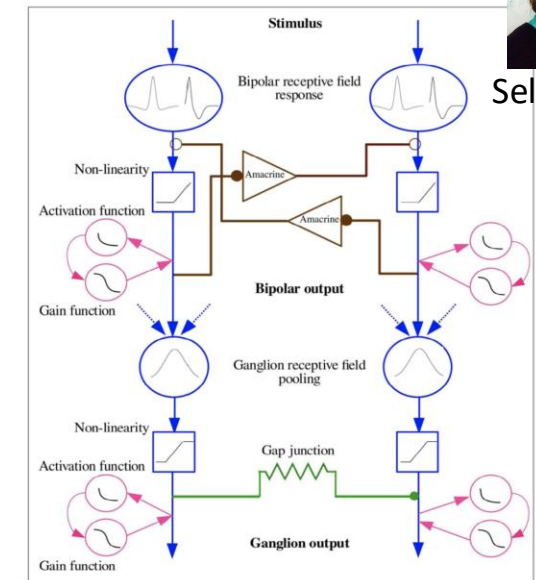

Souihel et al., 2021

Outlook

- **Anticipation of motion trajectories** via inhibitory network

? **Dynamic adaptation** for **speed** representation

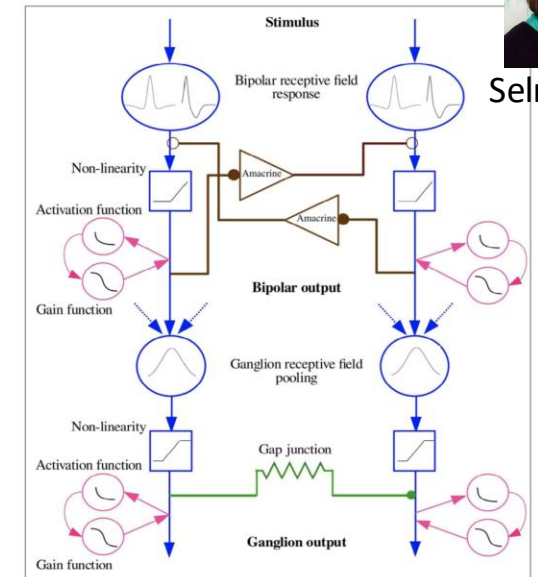
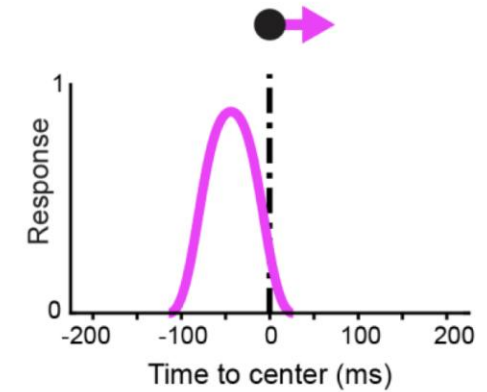
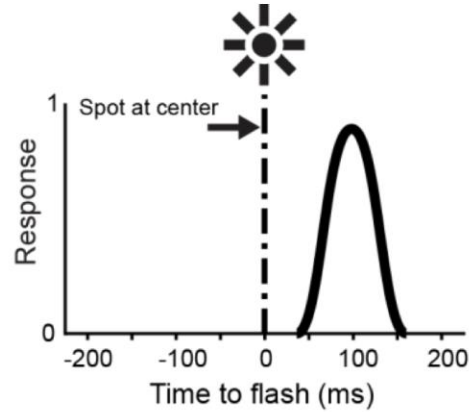
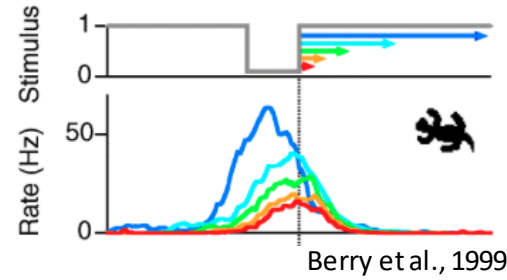

Selma Souhail

Outlook

- **Anticipation of motion trajectories** via inhibitory network

? Dynamic **adaptation** for **speed** representation

? Surprise to sudden **changes** in trajectories

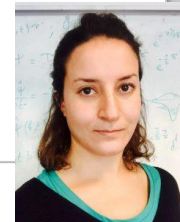
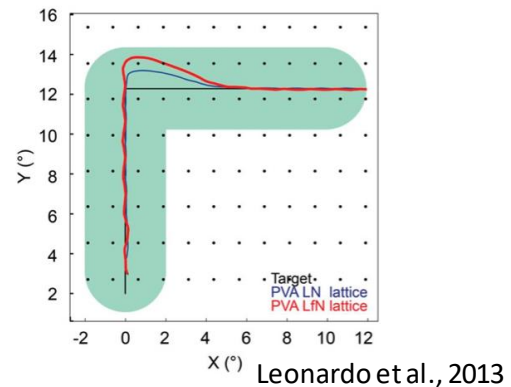
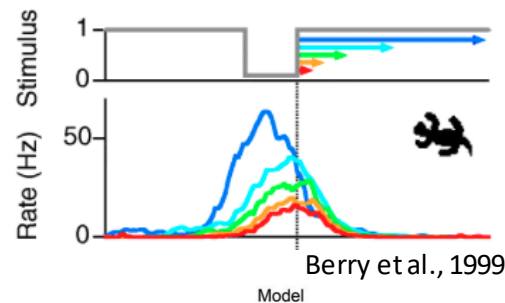
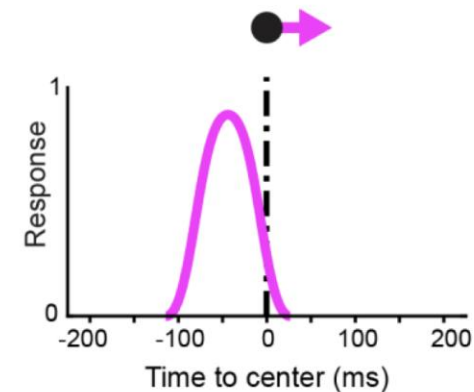
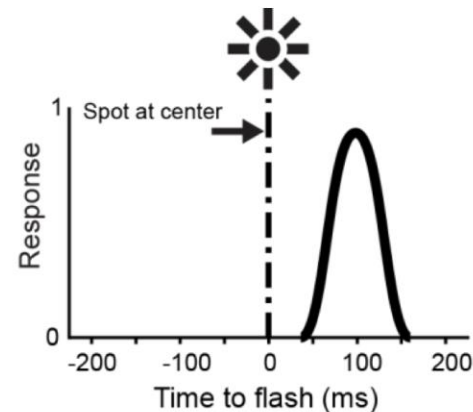

Selma Souihel

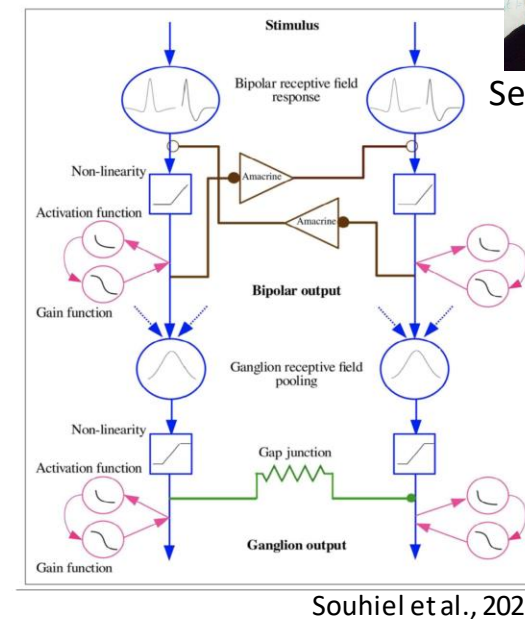

Thank you !

Bruno Cessac

Pierre Kornprobst

Hui-Yin Wu

Johanna Delachambre

Franz Franco Gallo

Alexandre Bonlarron

Jerome Emonet

Florent Robert

Clement Bergman

Jeremy Termoz-Masson

Erwan Petit

Sebastian Gallardo Diaz

Sebastian Vizcay

Olivier Marre

Thomas Buffet

B. Semihchan Sermet



Ebert et al., 2023,
in review



UNIVERSITÉ
CÔTE D'AZUR



Model produces **error signal** via excitation and slower inhibition

Additional inhibition shifts the latency

Plasticity scales latency shift to frequency

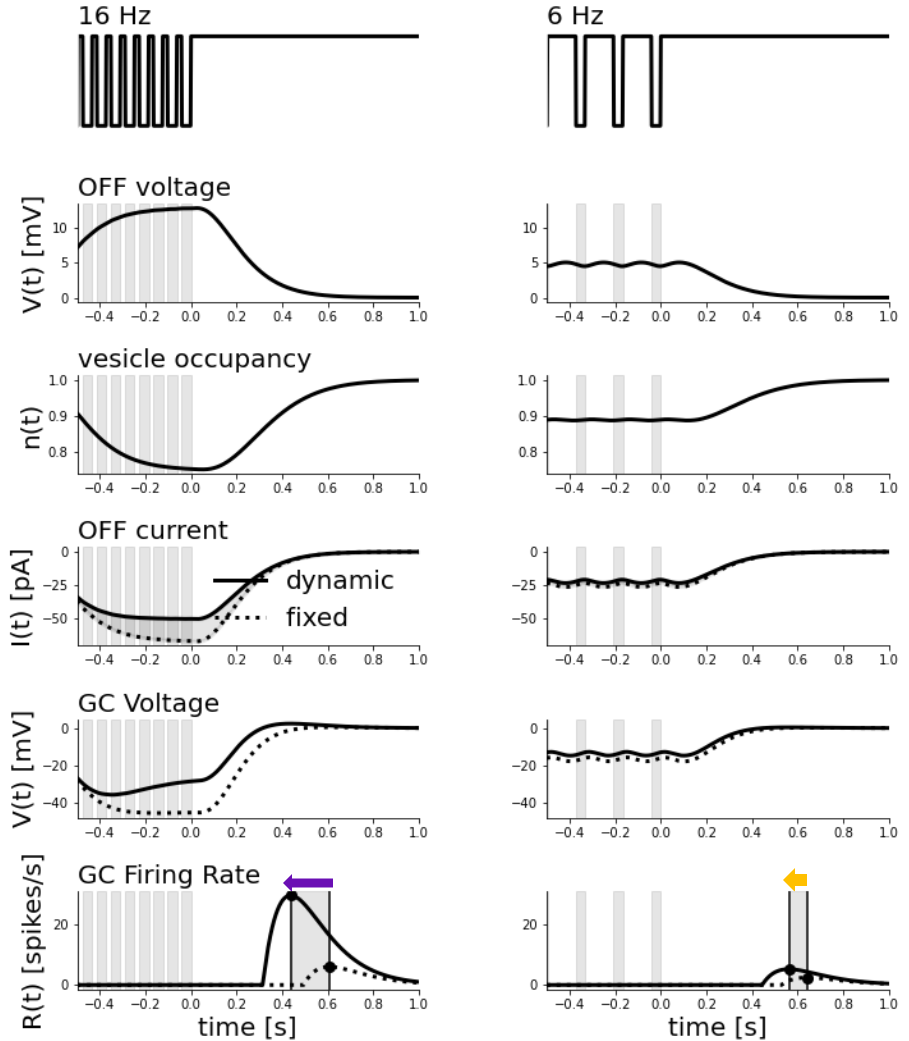
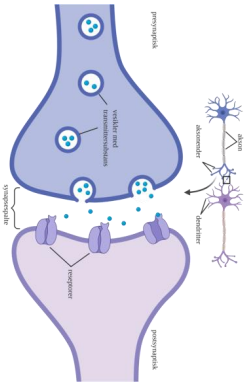

$$\frac{dV_G}{dt} = -\frac{V_G}{\tau_G} + w_{EON} V_{EON} + nw_{I_{Gly}^{OFF}} p(V_{I_{Gly}^{OFF}}, \theta_{I_{Gly}^{OFF}}) + w_{ION} V_{ION}$$

Model produces **error signal** via excitation and slower inhibition

Additional inhibition shifts the latency

Plasticity scales latency shift to frequency

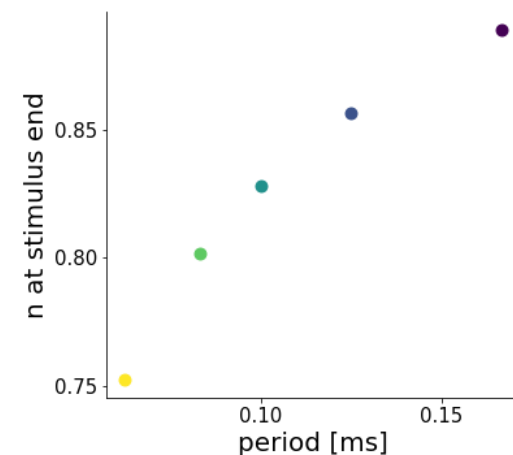
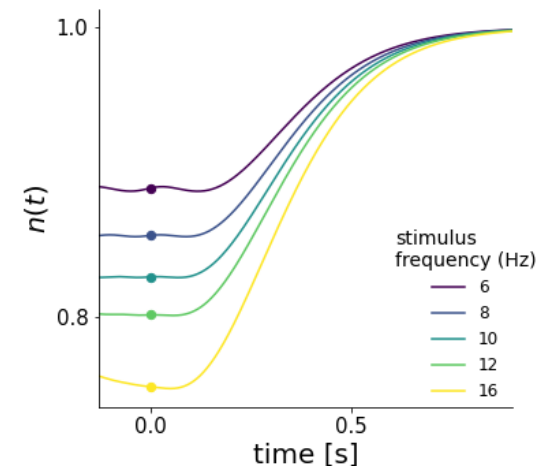
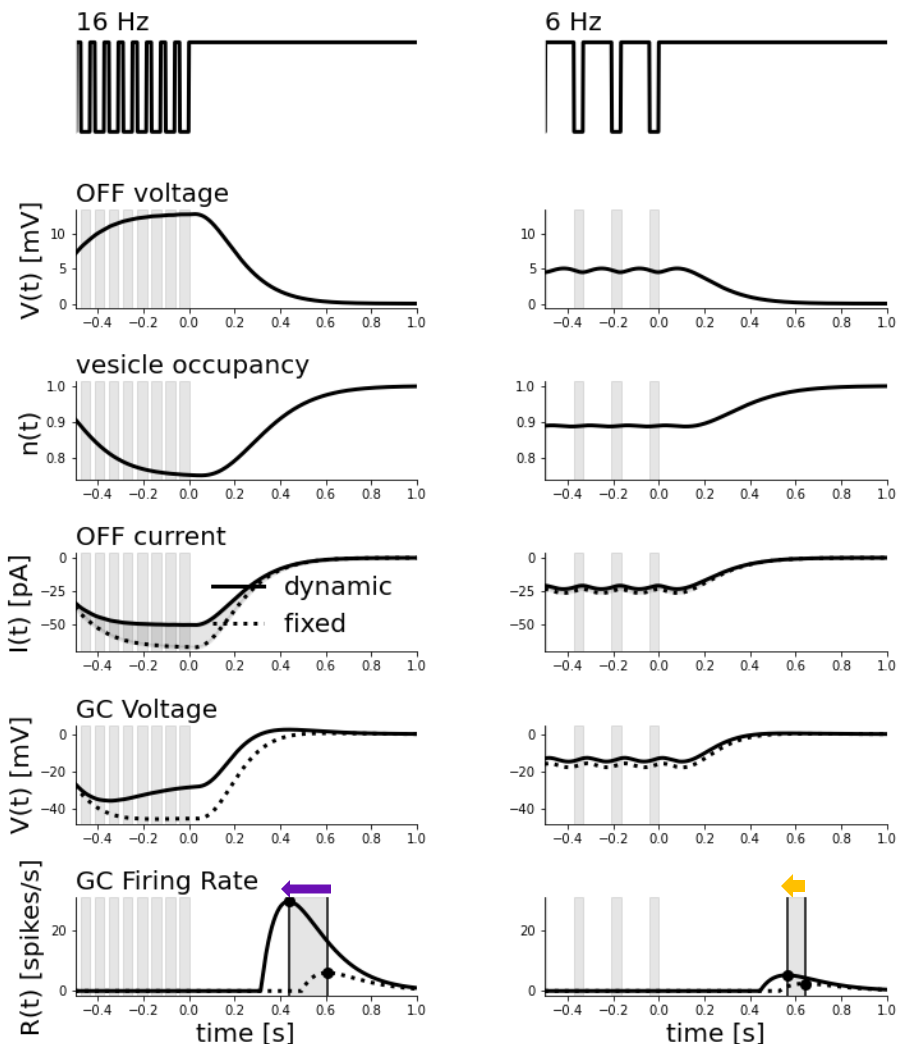
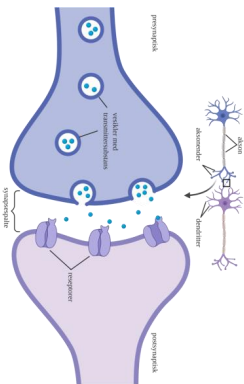

$$\frac{dV_G}{dt} = -\frac{V_G}{\tau_G} + w_{EON} V_{EON} + nw_{I_{OFF}^{Gly}} p(V_{I_{OFF}^{Gly}}, \theta_{I_{OFF}^{Gly}}) + w_{ION} V_{ION}$$

Model produces **error signal** via excitation and slower inhibition

Additional inhibition shifts the latency

Plasticity scales latency shift to frequency

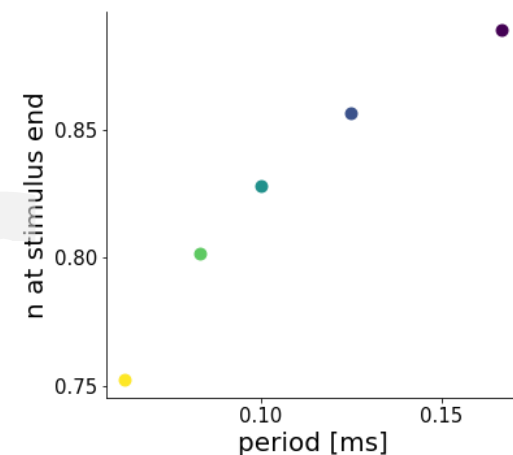
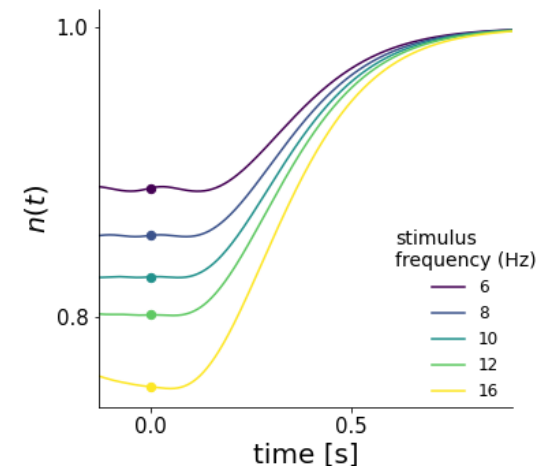
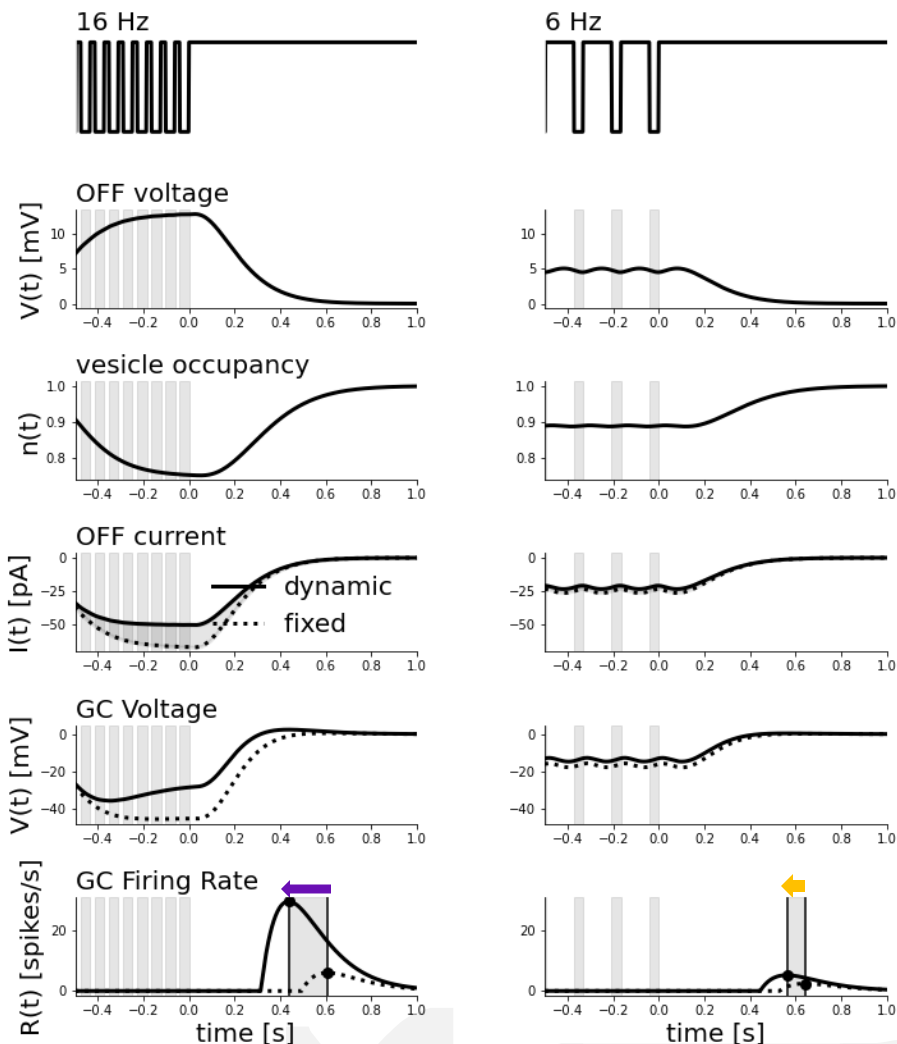
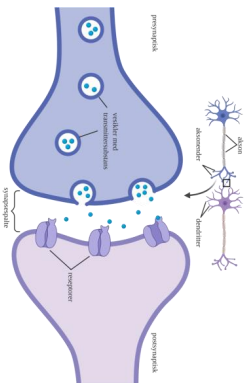

$$\frac{dV_G}{dt} = -\frac{V_G}{\tau_G} + w_{EON} V_{EON} + nw_{I_{Gly}^{OFF}} p(V_{I_{Gly}^{OFF}}, \theta_{I_{Gly}^{OFF}}) + w_{ION} V_{ION}$$

