



HAL
open science

VITAE: VIrTual brAin pErfusion

Alexandre Sauv , Jean-Daniel Julien, Maxime Berg, Myriam Peyrounette,
Pierre Elyakime, Yohan Davit, Maxime Pigou, Sylvie Lorthois

► **To cite this version:**

Alexandre Sauv , Jean-Daniel Julien, Maxime Berg, Myriam Peyrounette, Pierre Elyakime, et al..
VITAE: VIrTual brAin pErfusion. JCAD 2020 (Journ es Calcul Donn es), Dec 2020, Dijon (FR),
France. 2020. hal-04337309

HAL Id: hal-04337309

<https://hal.science/hal-04337309v1>

Submitted on 12 Dec 2023

HAL is a multi-disciplinary open access archive for the deposit and dissemination of scientific research documents, whether they are published or not. The documents may come from teaching and research institutions in France or abroad, or from public or private research centers.

L'archive ouverte pluridisciplinaire **HAL**, est destin e au d p t et   la diffusion de documents scientifiques de niveau recherche, publi s ou non,  manant des  tablissements d'enseignement et de recherche fran ais ou  trangers, des laboratoires publics ou priv s.



Open Archive Toulouse Archive Ouverte

OATAO is an open access repository that collects the work of Toulouse researchers and makes it freely available over the web where possible

This is an author's version published in: <https://oatao.univ-toulouse.fr/27639>

Official URL:

<https://jcad2020.sciencesconf.org/resource/page/id/7>

To cite this version:

Sauvé, Alexandre  and Julien, Jean-Daniel  and Berg, Maxime  and Peyrounette, Myriam  and Elyakime, Pierre  and Davit, Yohan  and Pigou, Maxime  and Lorthois, Sylvie  *VITAE : VlrTual brAin pErfusion*. (2020) In: JCAD 2020 (Journées Calcul Données), 2 December 2020 - 4 December 2020 (Dijon, France). .

Any correspondence concerning this service should be sent to the repository administrator: tech-oatao@listes-diff.inp-toulouse.fr



European Research Council
Established by the European Commission



Université
de Toulouse



VITAE

VirTual brAin pErfusion

ERC Proof of Concept VITAE (GA 825829)

JCAD 2020

Alexandre Sauv 

Institut de M canique des Fluides, Toulouse

Contributors: Jean-Daniel Julien, Maxime Berg, Myriam Peyrounette, Pierre Elyakime, Yohan Davit, Maxime Pigou ,
Sylvie Lorthois

Outline

Context

Software

Benchmarks & results

Return on experience

Perspectives

Context

Problem

Blood flow is vital for feeding and cleansing neurons

Recent discovery

Blood flow decrease before measurable cognitive decline in Alzheimer's Disease (2016)

Novel therapeutic strategy

development of drugs targeting the vascular system

Idea

Use HPC simulation of cerebral blood flow to accelerate vascular targeted drug development

Background



Blood flow study

- Vascular networks have a complex topology
- Blood itself is a complex fluid

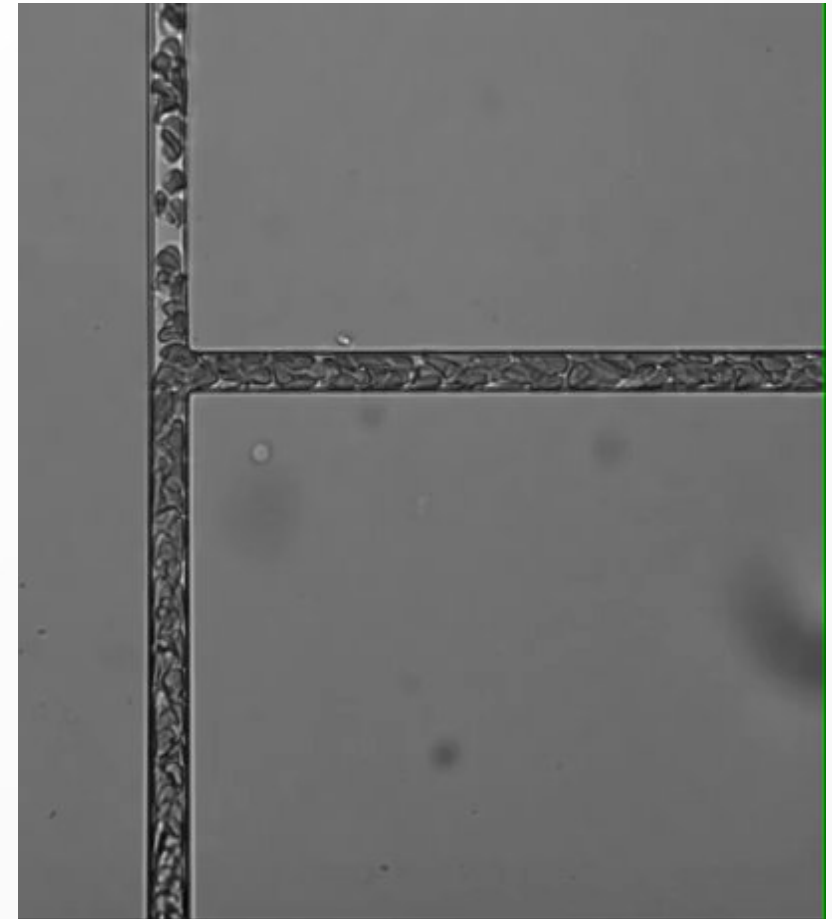

Blood flow simulations

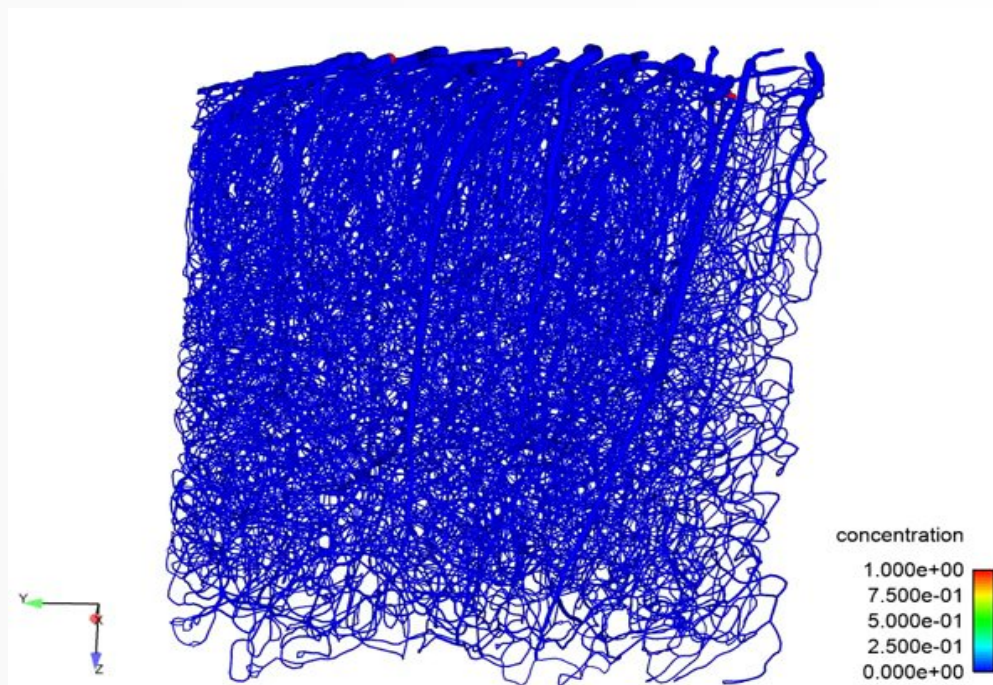

PhD IMFT Maxime Berg, Berg et al. 2020

1 mm³ mouse brain

Previous Simulations (using V1.0)
14k vessels

Issue

Does not scale up for
large vascular networks

Whole mouse brain imaging

International effort to acquire whole mouse brain vascular networks

2020: publication of a pipeline reconstructing the full vascular network of a mouse brain at *Institut du Cerveau et de la Moelle épinière (ICM)*

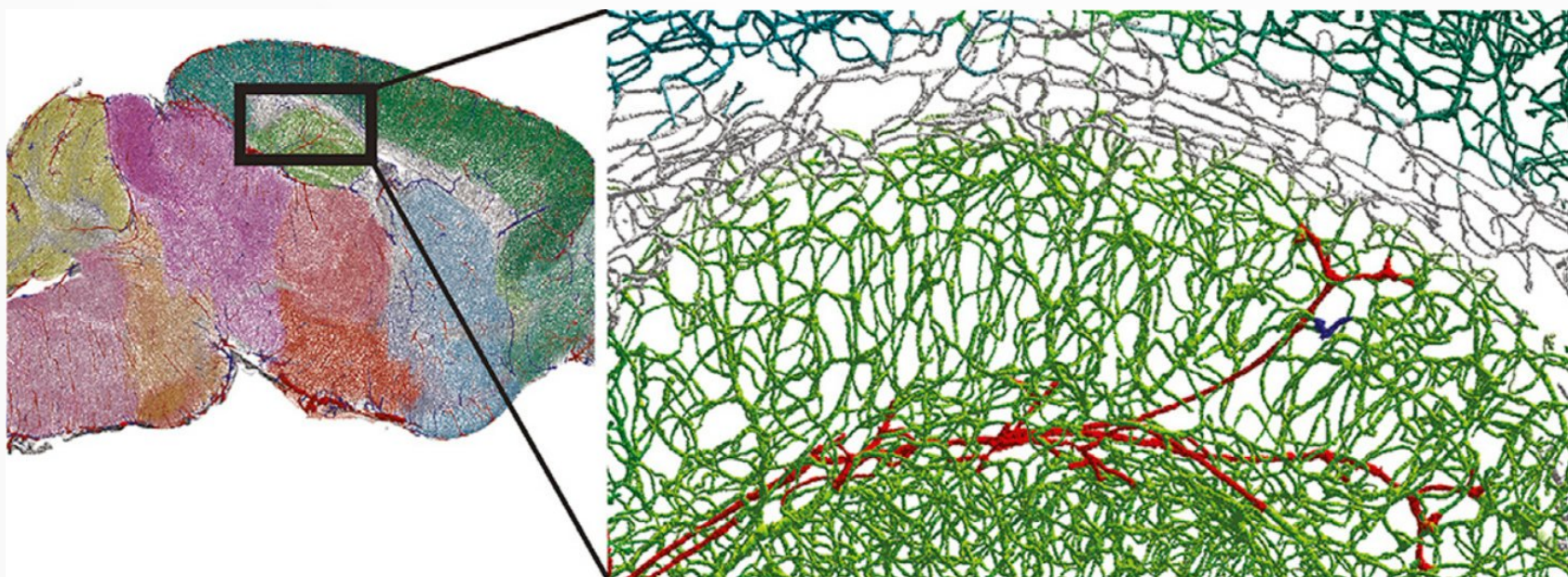

Whole mouse brain imaging

Example: Lightsheet microscopy

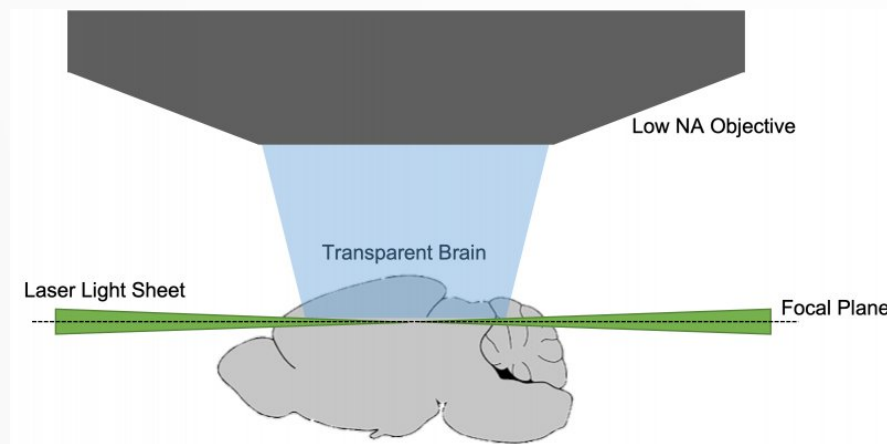

visikol.com

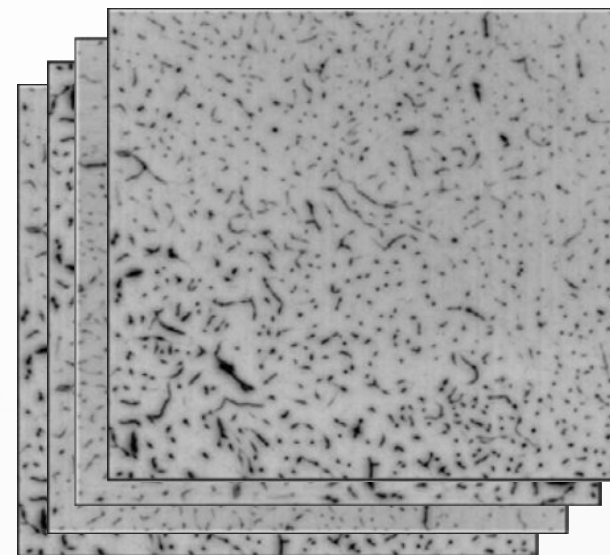

Kirst et al. 2020

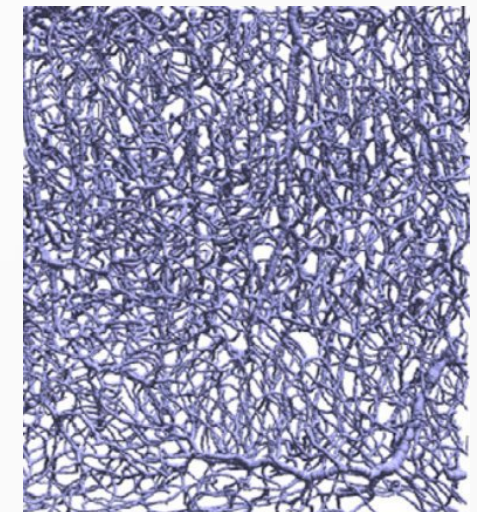

Kirst et al, 2020

Whole mouse brain imaging

Simulation goals :

- 5M to 10M vessels
- Pressure and blood flow
- Distribution of red blood cells
- Nutrient and drug delivery

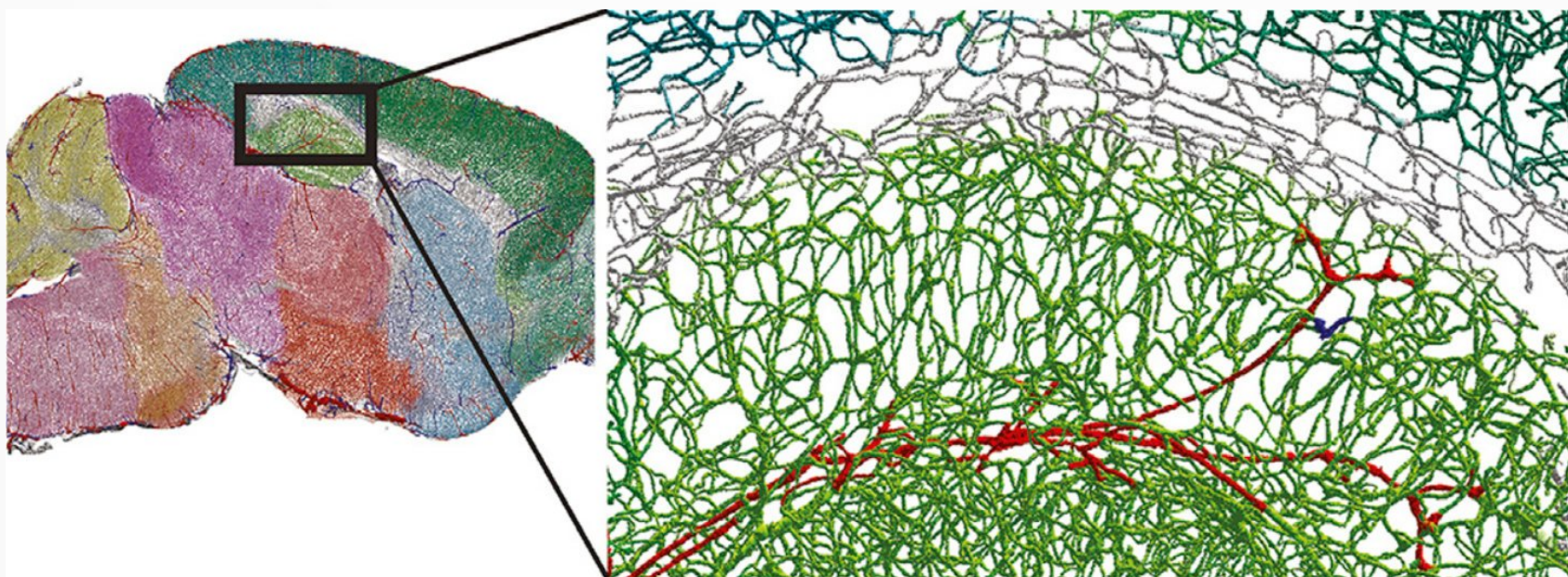

Flow solving

Electrical analogy

- $\Delta U = RI$
- $\Delta P = RQ$

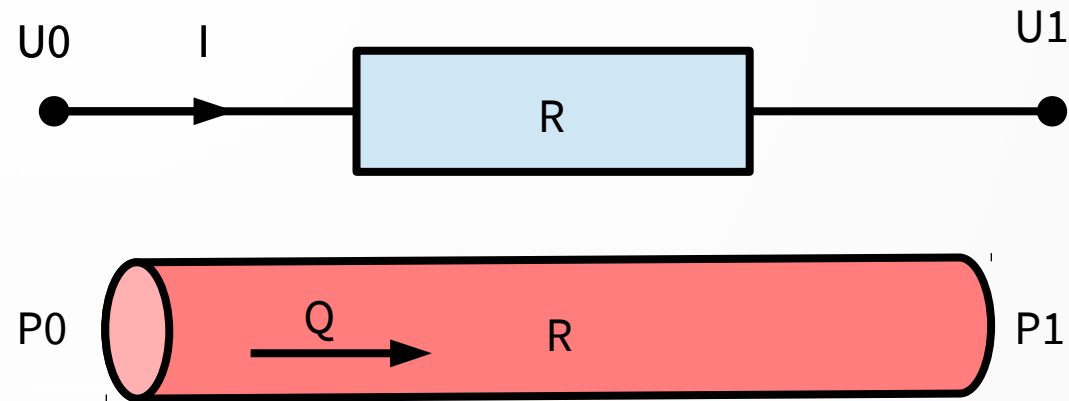

Matrix formulation for full brain

- Inversion of a $\sim 5M \times 5M$ sparse square matrix M
- Requires gradient descent like algorithm
- Requires parallel calculation

$$Mp = y$$

History

- 2014: V1 start
 - Research code in C++
 - Not scalable
 - Completely written on top of *PETSc*
- 2018: ERC POC grant
 - Scaling for full brain
 - Code industrialization
- 2019: V2 start
 - Hiring dedicated software engineer
 - Codebase mostly rewritten
- 2020: first tests on full brain data (Kirst et al.)

The VITAE software

Design goals

- Fully parallel processing
- CPU efficient
- Modern C++
- Modular API
- User friendly
- Fully documented

Dependencies

- std=c++14 (gcc9, ICC 18 & 19)
- Compilation (cmake-3.10)
- MPI (OpenMPI-2.1.1, MPICH-3.3.2)
- Parallel IO (HDF5-1.10.5)
- Linear algebra (PETSc-3.7.7)
- Graph partitioning (Parmetis-4.0.3)
- JSON Config (nlohman-json-3.7)
- JSON Schema #7 (pboettch-2.0)
- Unit tests (cxxtest-4.4)

Data model

Vascular networks have a graph structure

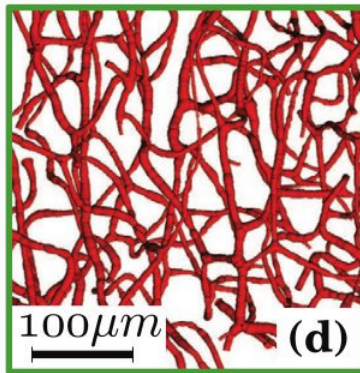

Peyrounette et al. 2018

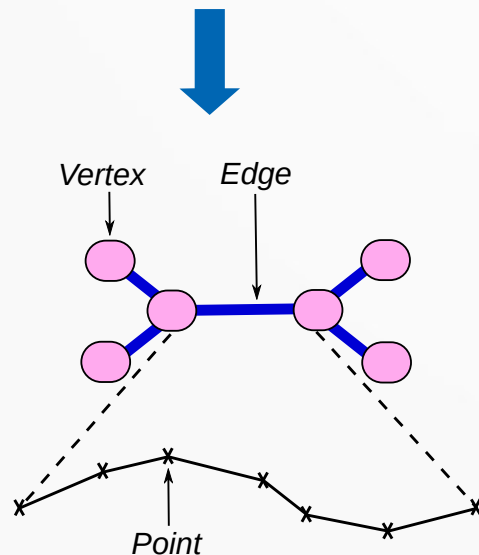

Three major categories

- vertex for bifurcations
- edge for vessels
- point for vessels path (grouped by edge)

Network	Size [vertex]	Memory footprint estimation
[V1] Kleinfeld (mouse)	10 k	11.7 MiB
[V2] Average mouse brain	5 M	6.1 GiB
Average Human brain	> 1 G	> 1.2 TiB

Data flow

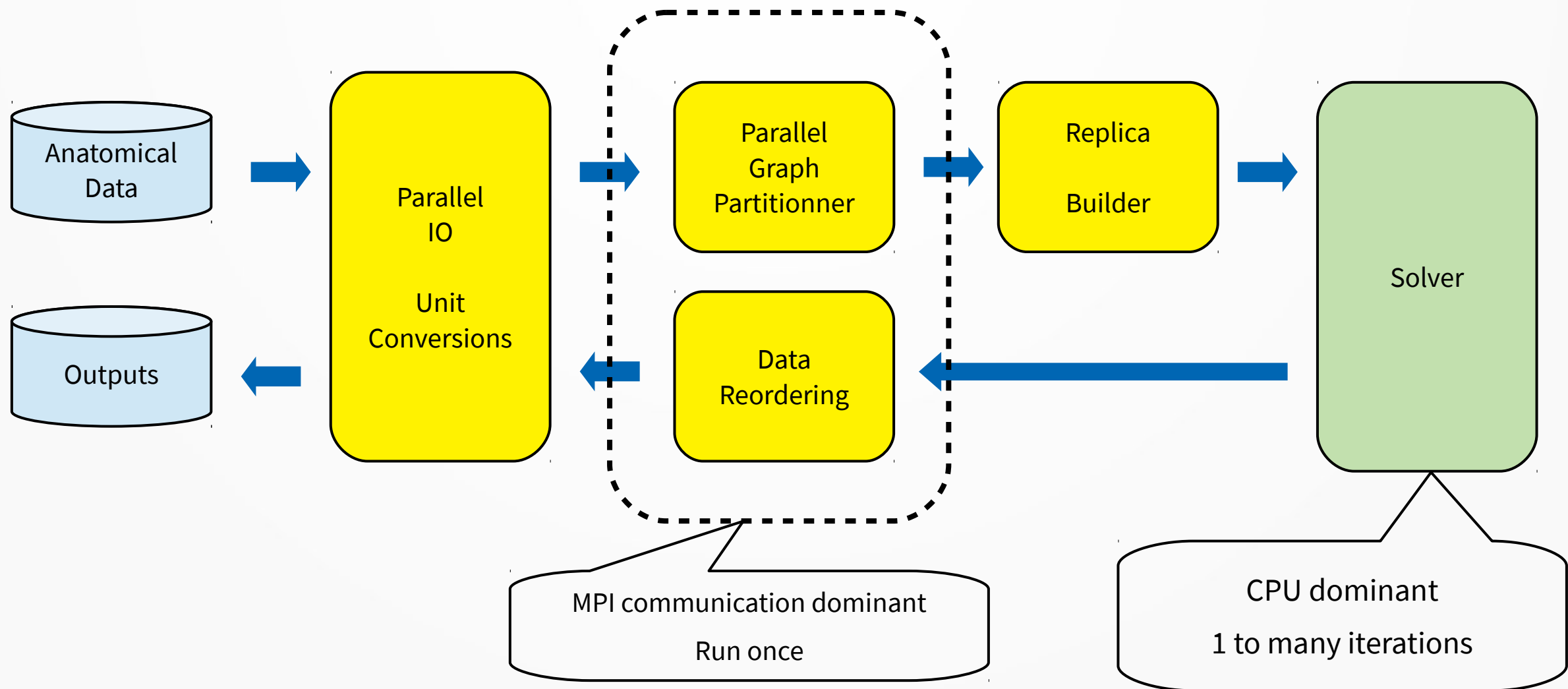

Graph Partitioning

Initial graph

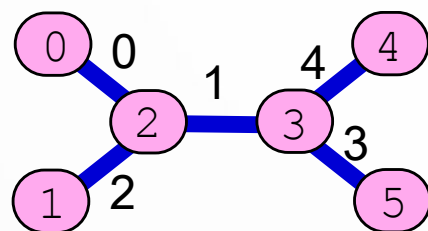

Partitioning
minimize nb of edge cuts

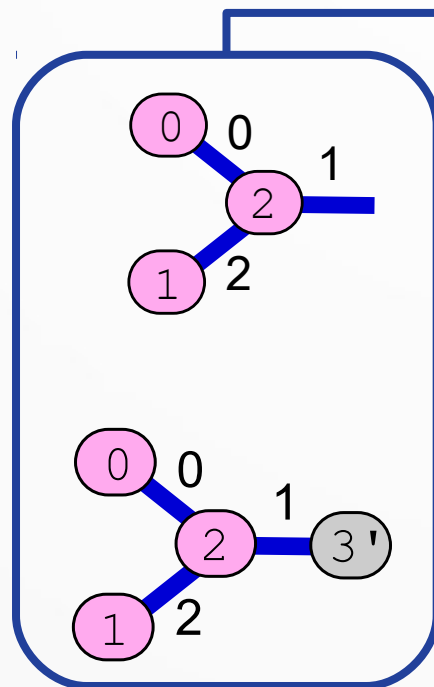

Replica insertion
(ghosts)

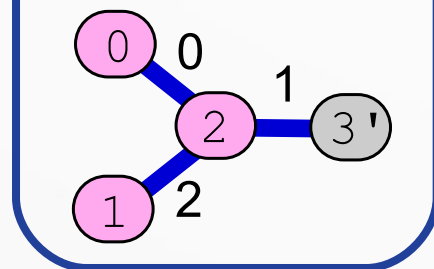

process0

process1

...

8 partitions
(Parmetis)

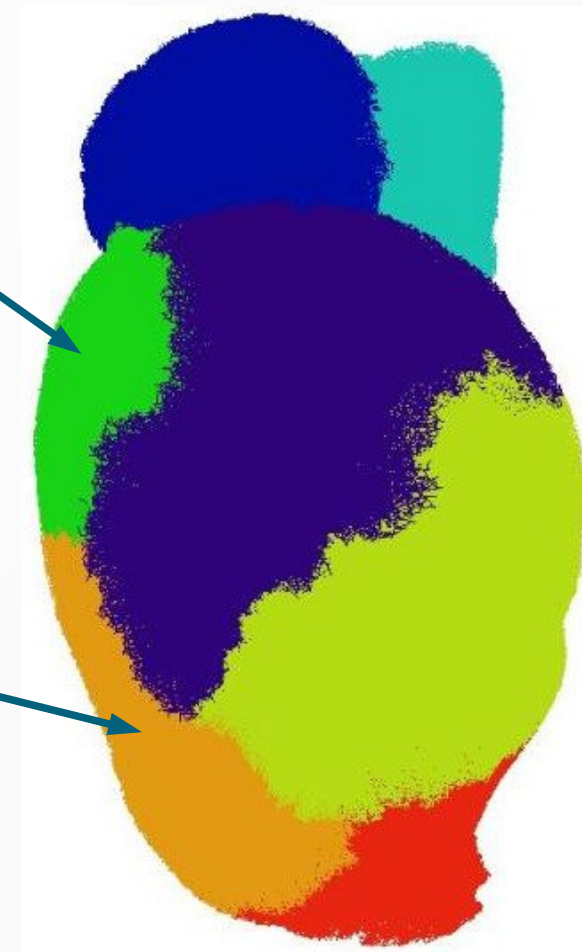

PhD Marion Giraud IMFT

Benchmarks

Efficiency of graph partitioning

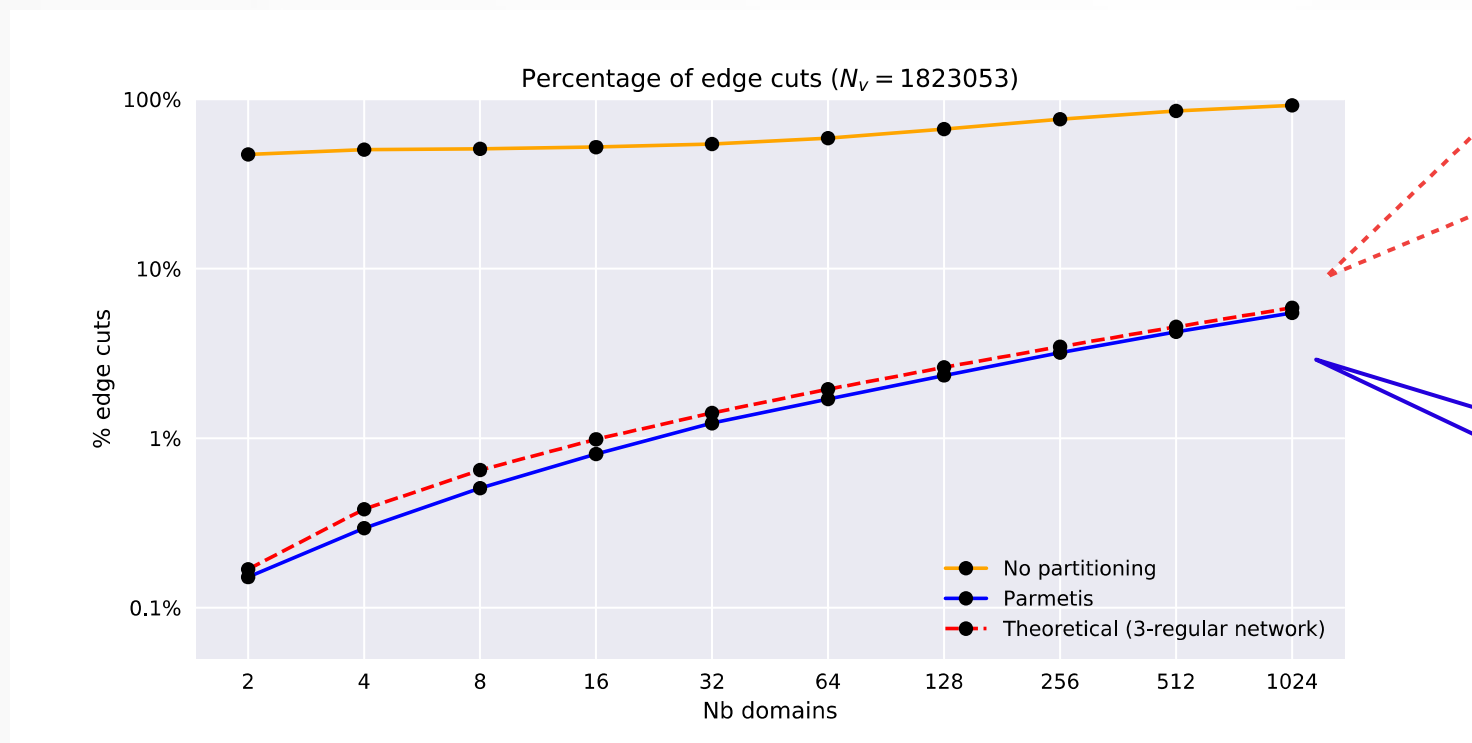

Lower is better

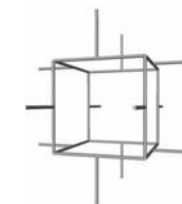

3-regular
Synthetic network

$$ncut \sim O(N_d^{1/3} \times N_v^{2/3})$$



1.8M vertex network
(Kirst 2020 CU)

Benchmarks

MPI CPU scaling for Flow Solver

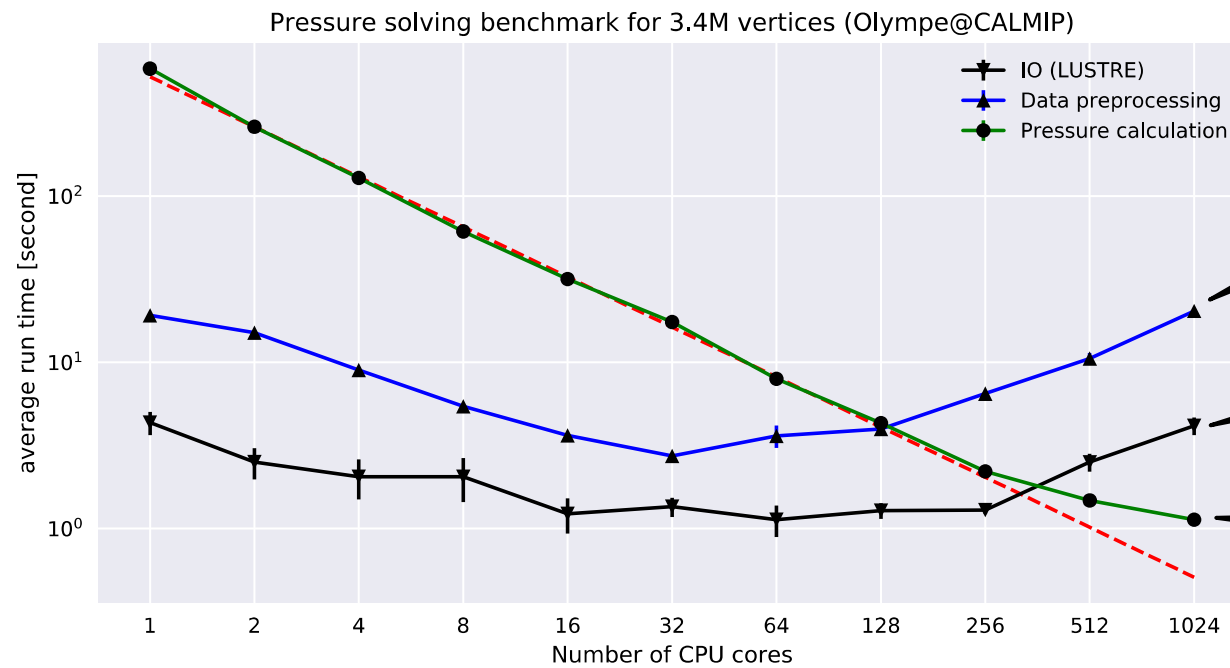

Partitioning
and pre/post processing
MPI communication dominant
run once

File system access
run once

Flow calculation
CPU dominated
run many

Lower is better

Benchmarks

MPI peak memory scaling for 1 process

Profiling tool: `valgrind --tool=massif`

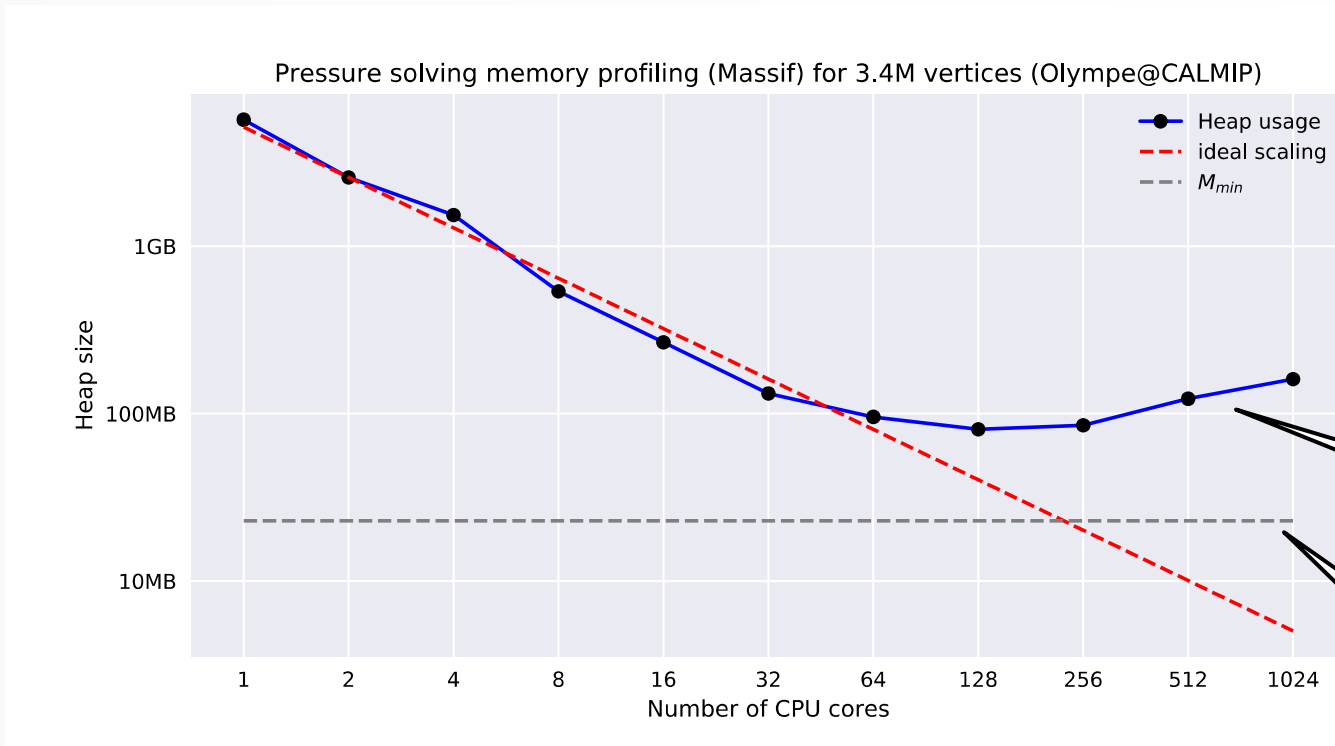

Lower is better



`ms_print massif.out`

Memory excess
Dominated by
Parmetis MPI buffers

*Minimum
Process size*

Results

Full brain pressure and flow rate calculation

- Half mouse brain
- Data source:
 - ICM (Kirst et al. 2020 CU)
 - HDF5 File size: 507MB
 - Nb vertices: 3.4M
 - Nb edges: 4.7M
- Calculation
 - Olympe@CALMIP
 - ~10 minutes
 - one process
- Visualization
 - Avizo

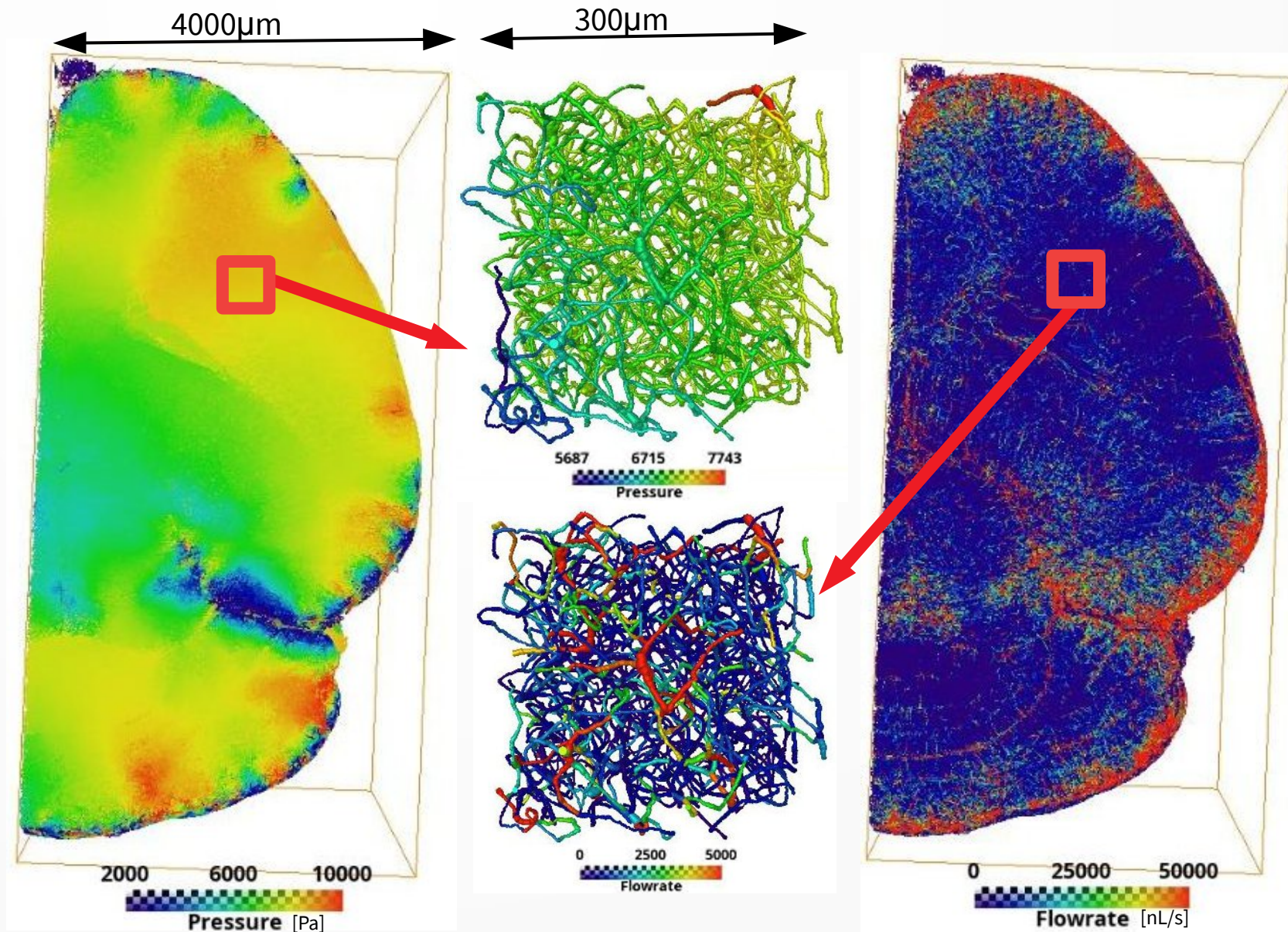

Issues

Technical

- PETSC installation & config
- Direct use of HDF5 instead of PETSc wrapping
- MPI is not very well suited for graph manipulation
 - Graph structure requires to call various mixtures of `Mpi_Alltoall()` and `Mpi_Alltoallv()`
 - Average nb of connected domains is 13 which may require specific optimizations
- Intel ICC18 compiler (`std::shared_ptr<std::array>`, etc.), ICC19 easier
- CMake steep learning curve, one has to use modern version
- C++ version of dependencies often not available or incomplete
Example: HDF5, PETSc, MPI, etc.

Other

- Semantic
 - Example: disambiguate UIDs versus global offset and local offset

Solver teamwork

Solver specifications

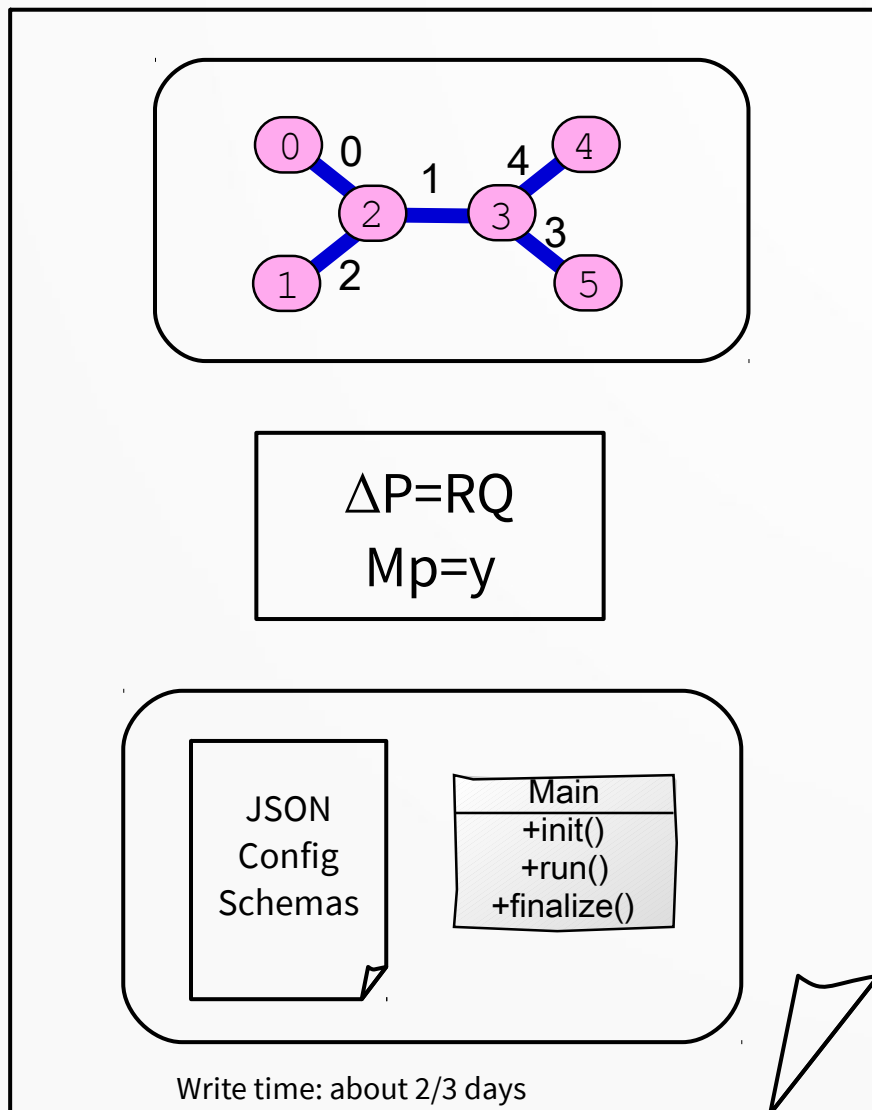

1) Scientific goal
Mesh definition

2) Numerical scheme
Algorithm

3) Code Specifications
Data, Object Model

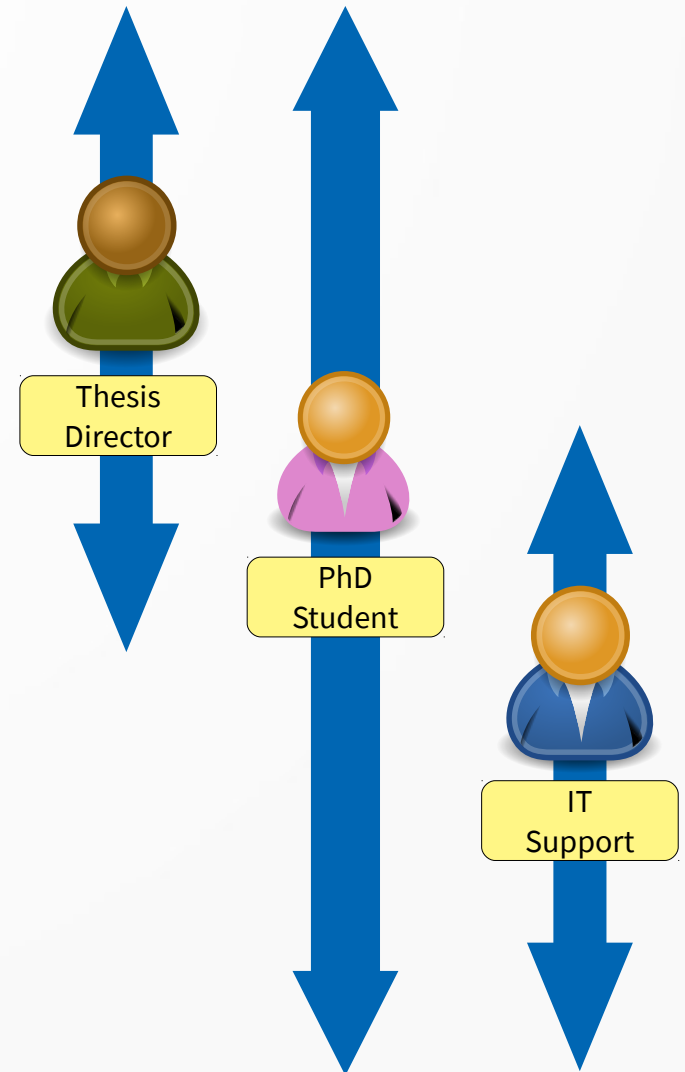

Software quality

Continuous integration

- Git versionning
- Wiki
- Runners
- unit tests



GitLab

Naming convention document

Schema validation

Documentation

- Latex manual
- Rich doxygen code snippets

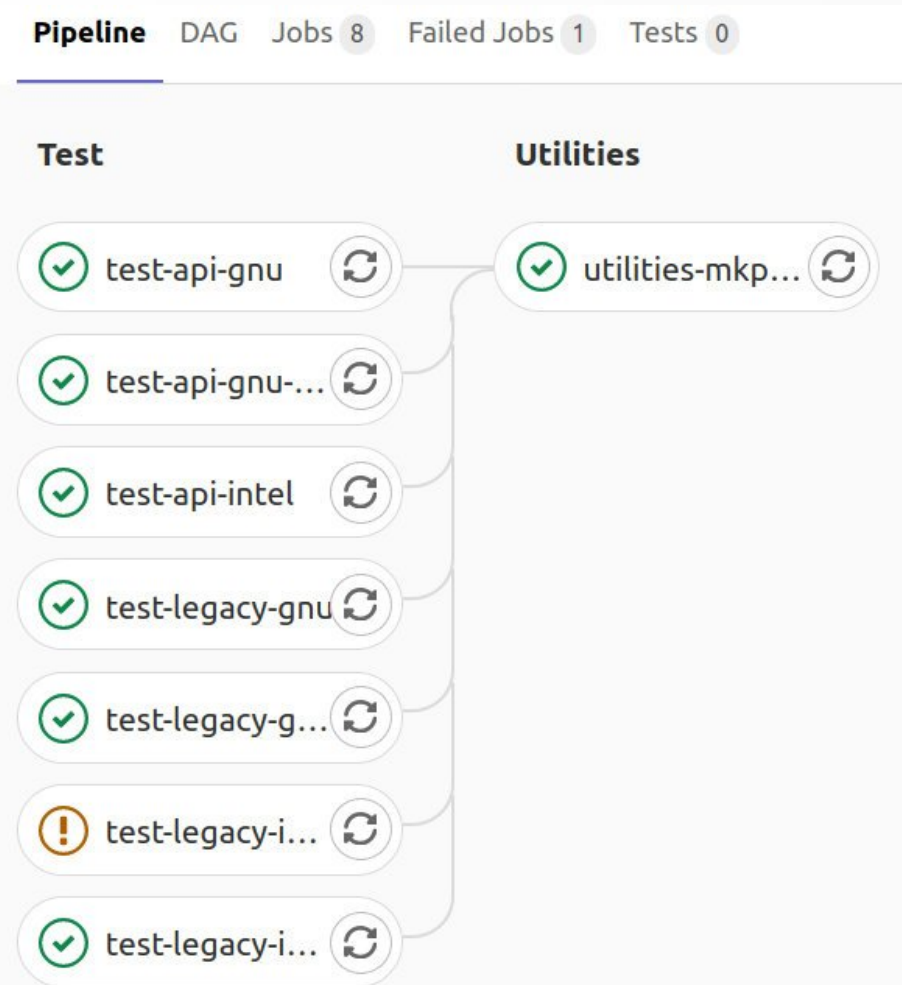

Scheduled Projects

- Solver: *BrainPulse*
 - Solver for blood pulsatility
 - Project lead: Alexandra VALLET (univ. oslo)
- Solver: *BioGrow*
 - Simulation of bacterial growth
 - Project lead: Jean-Daniel Julien
- Solver: *PhaseSeparation*
 - Calculation of blood cells concentration in plasma
 - Initial author: Maxime Berg
 - Porting to VITAE API V2: Maxime Pigou
- Solver: *MassTransport*
 - Simulation of solute transport into blood
 - Initial author: Maxime Berg
 - Porting to VITAE API V2: Alexandre Sauv 

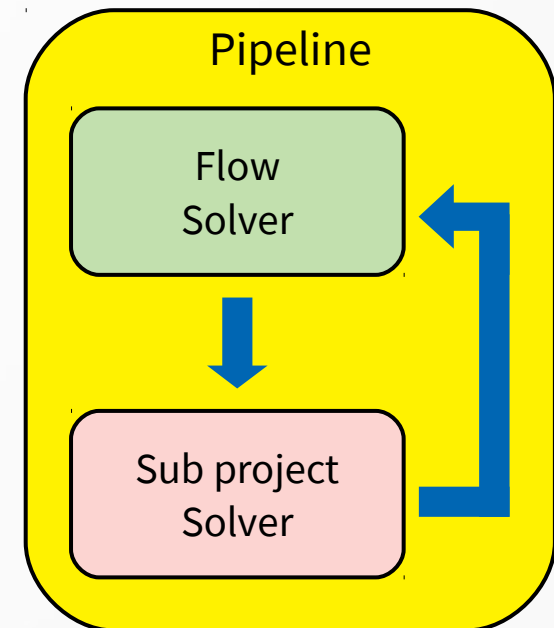
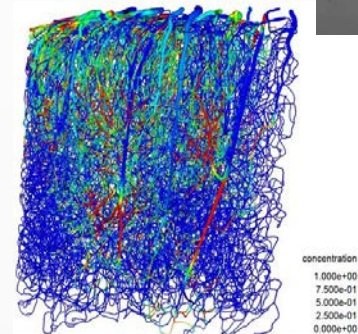
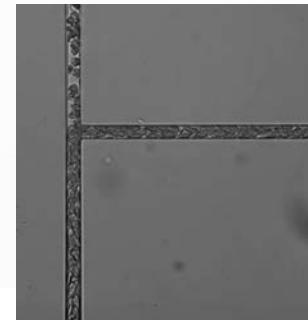
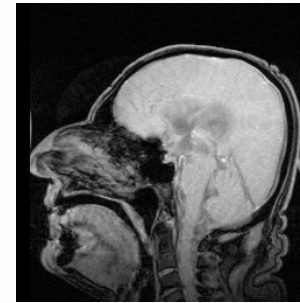
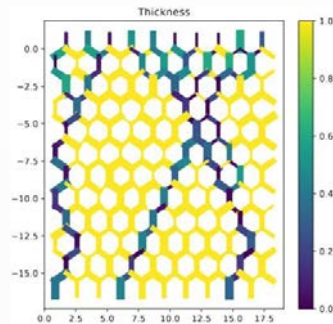

depth 2
iterative solvers

Evolutions

Technical

- Improve flow solver convergency time (*PETSc* KSP methods)
- Improve partitioning scaling (Example: test *PT-SCOTCH*)

Data exploitation

- New vascular networks from various collaborations
- Reduction of full brain results

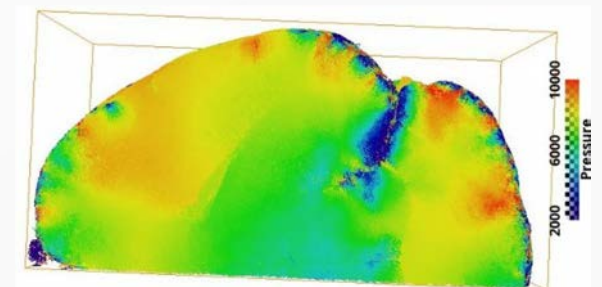
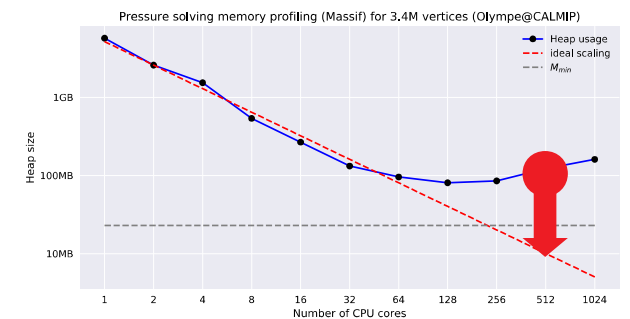
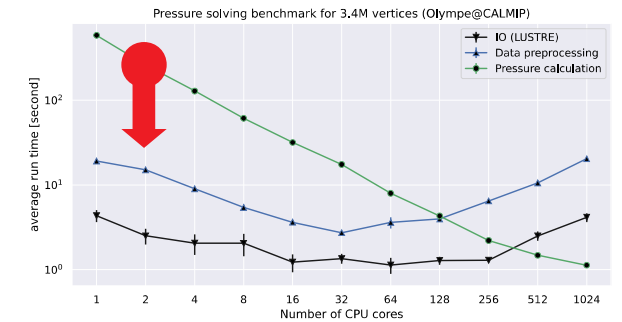

Questions

