



**HAL**  
open science

## A High-Throughput Experimental Approach to Screening Gas Sorption by Liquids and Solids

J. Mark Young, Sam H Mccalmont, Sophie Fourmentin, Panagiotis Manesiotis, John D Holbrey, Leila Moura

► **To cite this version:**

J. Mark Young, Sam H Mccalmont, Sophie Fourmentin, Panagiotis Manesiotis, John D Holbrey, et al.. A High-Throughput Experimental Approach to Screening Gas Sorption by Liquids and Solids. ACS Sustainable Chemistry & Engineering, 2023, 11 (50), pp.17787-17796. 10.1021/acssuschemeng.3c05901 . hal-04332289v1

**HAL Id: hal-04332289**

**<https://hal.science/hal-04332289v1>**

Submitted on 8 Dec 2023 (v1), last revised 19 Dec 2023 (v2)

**HAL** is a multi-disciplinary open access archive for the deposit and dissemination of scientific research documents, whether they are published or not. The documents may come from teaching and research institutions in France or abroad, or from public or private research centers.

L'archive ouverte pluridisciplinaire **HAL**, est destinée au dépôt et à la diffusion de documents scientifiques de niveau recherche, publiés ou non, émanant des établissements d'enseignement et de recherche français ou étrangers, des laboratoires publics ou privés.



Distributed under a Creative Commons Attribution 4.0 International License

# A High-Throughput Experimental Approach to Screening Gas Sorption by Liquids and Solids

J. Mark Young, Sam H. McCalmont, Sophie Fourmentin, Panagiotis Manesiotis, John D. Holbrey, and Leila Moura\*



Cite This: <https://doi.org/10.1021/acssuschemeng.3c05901>



Read Online

ACCESS |

 Metrics & More

 Article Recommendations

 Supporting Information

**ABSTRACT:** High-precision measurement of gas uptake from single or mixed feeds in solid and liquid sorbents traditionally requires time-consuming experimental procedures and/or complex and costly equipment. A simple and cost-effective headspace gas chromatography (HS-GC) approach for the fast, universal experimental screening of sorbents for gas uptake and/or determination of their real gas separation selectivity has been developed and is demonstrated for pressures up to 2500 mbar and temperatures above 30 °C. This method allows screening of solids and both volatile and nonvolatile liquid materials, physisorbents, and chemisorbents using both single and mixed permanent gases that can include CO<sub>2</sub>, CH<sub>4</sub>, H<sub>2</sub>, and NH<sub>3</sub>, for gas uptakes as low as 0.04 mmol or 1.8 mg of CO<sub>2</sub>. We estimate that this method allows for the screening of at least 30–96 sorbents (in triplicate) or 90–264 sorbents (singles) per day, representing at least a 90–3000 times reduction in the time required for equivalent analysis.

**KEYWORDS:** Gas uptake, Gas solubility, Gas separation, Gas capture, High-throughput screening, CO<sub>2</sub>, CH<sub>4</sub>, Ethylene

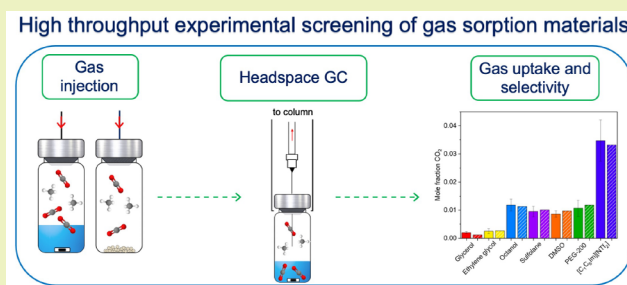

## INTRODUCTION

Gas capture and separation research holds significant importance due to its contribution to the development of technologies related to energy security and efficiency, climate change mitigation, and the integration of renewable energies. To do this, knowledge of multicomponent phase equilibria is crucial to design separation processes and equipment, perform catalytic reactions, and effective gas capture and storage. The current interest in developing CO<sub>2</sub>, CH<sub>4</sub>, H<sub>2</sub>, and NH<sub>3</sub> capture, transport, conversion, and/or storage applications using materials such as microporous solids, ionic liquids (ILs), deep eutectic solvents (DES), and porous liquids (PLs) has led to a steady increase in publications on gas–liquid and solid phase equilibria.<sup>1–5</sup> However, progress is limited by the lack of experimental screening methods that can assess a large number of samples quickly.

A variety of methods have been developed to address the challenges associated with the measurement of vapor–liquid equilibria (VLE).<sup>6</sup> The most popular of these methods are either synthetic, where the properties of a precisely known mixture are investigated or analytical, where compositions of equilibrium phases are determined.<sup>6</sup>

Examples of synthetic methods include volumetric and bubble point analyses (for liquids). Volumetric techniques measure the volume, or associated pressure drop, of sorption of a gas by a known amount of sorbent.<sup>7</sup> The bubble point technique determined the temperature/pressure points at

which bubbles initially form from a gas saturated liquid.<sup>8</sup> Such techniques require relatively simple equipment and have potential for miniaturization; however, the precision required for the preparation of the mixtures and the determination of additional properties required for sorption calculations (e.g., phase densities) can be challenging. Additionally, there is less information that can be directly obtained from these measurements in comparison with analytical techniques, and so synthetic methods are most useful for binary systems.<sup>6</sup>

Analytical methods include gravimetric (microbalance or bubbling/weighing), NMR and (inverse) gas chromatography.<sup>9</sup> Gravimetric methods are commonly applied to solids and low vapor pressure liquids, the simplest approach being to weigh the sorbent before and after contact with gas samples.<sup>10</sup> Gravimetric microbalances require only very small sample sizes to make accurate measurement of solubility and diffusivity simultaneously for absorption and desorption isotherms.<sup>7,11,12</sup> NMR has also been used to determine gas uptake by pressurizing the sorbent with the desired gas in a high-pressure NMR tube. Although affording less accurate results, an

**Received:** September 14, 2023

**Revised:** November 14, 2023

**Accepted:** November 14, 2023

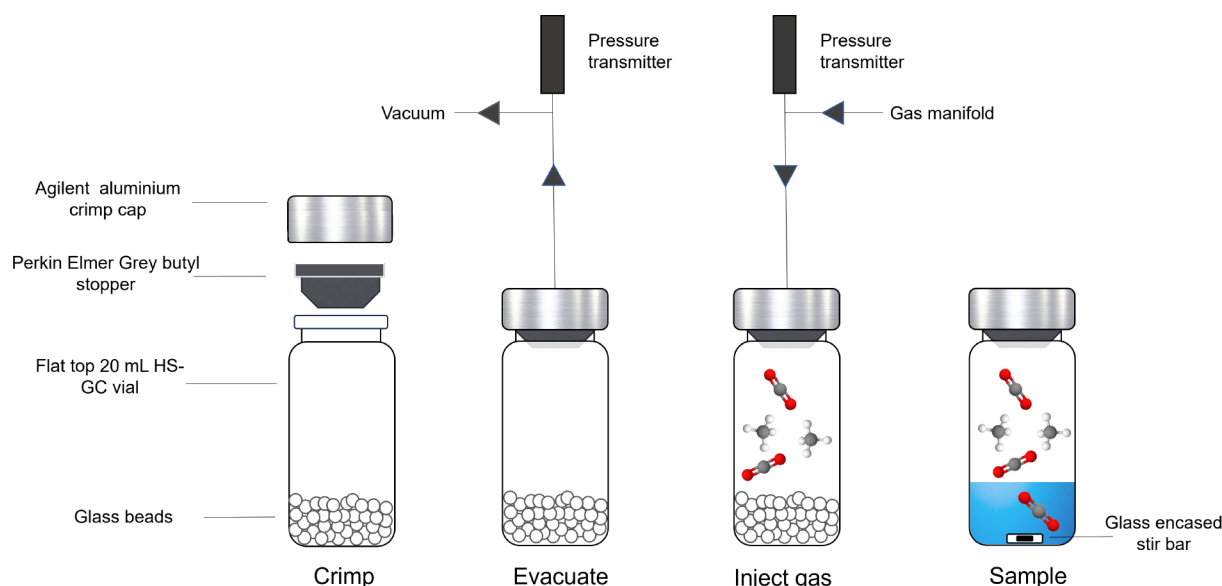

**Figure 1.** Summary of the sample preparation process for vials with glass beads or with liquid sorbents in headspace gas chromatography (HS-GC) for calibration curves or gas uptake experiments, respectively. This includes the method for measuring the pressure in the vial with a pressure transmitter.

advantage of this technique is that additional structural or reaction information can be obtained.<sup>13</sup> Gas and gas–liquid chromatography (GC and GLC) can be used to determine infinite dilution activity coefficients of volatile liquids or gases in low volatility liquid sorbents coated on a stationary gas chromatography phase.<sup>14</sup> Retention times are correlated with the infinite dilution activity coefficients of the solutes and solubilities in the form of Henry's Law constants and thermodynamic properties of solvation have been derived.<sup>15,16</sup> Typical difficulties associated with analytical methods are related to the accurate determination of the composition of the phases in equilibrium, for example, the need to add calibration data or account for buoyancy effects.

The majority of studies in the relevant literature are devoted to single gas uptake and assume ideal mixing and selectivities for the mixed gas separation. While this is a good approximation for ideal systems or when the solubility/uptake of the gas is low, for complex, high capacity, or reactive systems, experimental data for mixed gas separation becomes more critical, particularly in view of commercial applications.

Combined methods have been developed to study multi-component gas mixtures, for example, using a volumetric or gravimetric technique associated with a single qualitative GC analysis of the headspace. This still involves, however, the *in situ* measurement of one system at the time after equilibrium is reached and generates the disturbance of said equilibrium. Naturally it then requires longer or a larger number of measurements.<sup>17,18</sup>

Here we describe a new method that combines the pressure drop technique on samples contained in pressurized headspace GC (HS-GC) vials (between 500 and 2500 mbar) with quantitative GC analysis of the equilibrated headspace.

Simple sample preparation and loading, simultaneous equilibration of a large number of samples, and straightforward quantitative headspace gas analysis allows rapid streamlining compared to typical solubility or gas-uptake measurements by both solid and liquids sorbents across a range of moderate temperatures and pressures, with either pure gases or gas mixtures.

The universality of this methodology has been demonstrated by benchmarking with single and mixed CO<sub>2</sub>, CH<sub>4</sub>, C<sub>2</sub>H<sub>6</sub>, and C<sub>2</sub>H<sub>4</sub> gases and a variety of solid (molecular sieves 3 and 4 Å, and zeolite RHO) and liquid sorbents including organic solvents (glycerol, 1-octanol, dimethyl sulfoxide, sulfolane, ethylene glycol, and polyethylene glycol 200), aqueous monoethanolamine, ionic liquids with and without added silver salts, and a type-III porous liquid (zeolite RHO in Genosorb).

To our knowledge, this is the first fast experimental screening method available for determining gas uptake/solubility and real separation selectivity and for such a variety of sorbents and without disturbing or manipulating the sorbent.

## EXPERIMENTAL SECTION

**Materials.** Dimethyl sulfoxide (DMSO, purity 99.9%), polyethylene glycol 200 (PEG200), glycerol (anhydrous for synthesis), ethylene glycol (purity 99%), 1-octanol (purity 99%), and sulfolane (purity 99%) were used as purchased from Sigma-Aldrich. Molecular sieves types 3 and 4 Å were purchased from Thermo scientific and were activated in a vacuum oven overnight at 150 °C. Zeolite RHO and zeolite RHO in Genosorb 1753 at 25 wt % (porous liquid) were kindly provided by Porous Liquid Technologies. Zeolite RHO was activated overnight at 200 °C under vacuum. 1-Methylimidazole (purity of 99%) was purchased from Doug Discovery, 1-chlorobutane (purity of 99.5%), silver nitrate (purity of 99%), and sodium hydroxide (purity of 97%) were purchased from Sigma-Aldrich and lithium bis(trifluoromethanesulfonyl)imide (Li[NTf<sub>2</sub>]) was purchased from 3M (noted as “highly pure”). The aqueous monoethanolamine (MEA) solution was made by mixing deionized water with MEA at a concentration of 30 wt % in MEA. Ionic liquids, 1-butyl-3-methylimidazolium chloride ([C<sub>4</sub>C<sub>1</sub>Im]Cl), bis(trifluoromethanesulfonyl)imide ([C<sub>4</sub>C<sub>1</sub>Im][NTf<sub>2</sub>]), and 1-hexyl-3-methylimidazolium bis(trifluoromethanesulfonyl)imide ([C<sub>6</sub>C<sub>1</sub>Im][NTf<sub>2</sub>]), were prepared in-house as described in Supporting Information. The silver salt mixture with [C<sub>4</sub>C<sub>1</sub>Im][NTf<sub>2</sub>] contained 0.25 mol L<sup>-1</sup> of Ag[NTf<sub>2</sub>]. The water content of the sorbent materials (when relevant) is reported in Supporting Information. Carbon dioxide (CO<sub>2</sub>), methane (CH<sub>4</sub>), ethane (C<sub>2</sub>H<sub>6</sub>), ethylene (C<sub>2</sub>H<sub>4</sub>),

and 1:1 molar mixtures of CO<sub>2</sub>/CH<sub>4</sub>, and C<sub>2</sub>H<sub>6</sub>/C<sub>2</sub>H<sub>4</sub> (all 99.95% purity) were supplied by BOC and used as received.

**Headspace Gas Analysis.** Gas analysis was carried out using a PerkinElmer Clarus 500 gas chromatograph (GC) attached to a Turbomatrix 40 headspace (HS) autosampler using helium as a carrier and a flame ionization detector (FID) equipped with a methanizer using a nickel catalyst. The HS autosampler oven was set to equilibrate samples for 2 h at 35 °C (308 K) as the lowest possible temperature for this particular piece of equipment, but equilibration temperature can be easily modified. The method included a high pressure injection mode with a 40 psi injection for 2 min and a column pressure of 15 psi withdraw time of sample is 6 s withdraw time before the vial was vented. The needle transfer and line temperatures were set to 50 °C. The GC injector temperature was set to 50 °C, the oven to 70 °C and the FID detector and methanizer set to 350 °C with an H<sub>2</sub> flow of 45 mL/min. The carrier gas (helium) pressure within the column was set to 12.5 psig and has a split flow of 10 mL/min. In all experiments the GC column used was an Agilent J&W CP-Silica PLOT with a nominal geometry of 15 m × 0.32 μm i.d. × 4 μm d.f. Characteristic chromatographs with retention times for all gases are included in the Supporting Information. PerkinElmer 20 mL crimp CTC headspace vials (rated to 5.17 bar) and gray butyl stoppers (part number B0038137) were used for all experiments due to their superior sealing capabilities, including resealing after being pierced with 23S or 20 gauge point style 2 Hamilton luer lock needles and maintaining pressures up to 2.5 bar over 2 weeks.

**Method Description.** The first step of the method was to produce a calibration curve corresponding to a linear response of the detector to a range of pressures in the samples vials. To do this, a series of closed HS-GC vials at a variety of gas pressures were produced, in triplicate, either empty or containing predetermined volumes of glass beads (see Figure 1). The occupied volume (if any) in the calibration vials was set to ensure consistency in the results for sorbent samples occupying a large portion of the space. The glass beads served this purpose when needed, as a nonsorbing material. The HS-GC response to each gas was measured between pressures ranging from approximately 500 to 4000 mbar at 308 K.

Then, HS-GC vials containing a similar volume of sorbent samples as the calibration curve were produced and pressurized with the same gases at the same range of pressures. Air or water sensitive samples can be easily prepared in a glove box or bag under a controlled atmosphere and used with this method. Samples can be speedily produced, in triplicate and in large quantities, and left to equilibrate *ex situ*, affording this method another one of its advantages over traditional techniques. After equilibration, the detector response to the headspace gas samples can be correlated with the gas' pressure in the vial's free volume, and the gas uptake by the sorbent can be thus calculated.

The method for sample or calibration vial preparation can be divided in 3 steps: pressurization, equilibration, and HS-GC measurement. The pressurization process is summarized in Figure 1. The vials' headspace is first evacuated of any gases by applying vacuum through a needle piercing the gray septa and connected to a gas/vacuum line (see Figure 2). Then the vial is pressurized with the gas(es) and pressures of choice, which is accurately measured. The vials are then removed from the gas line and left to equilibrate *ex situ* at the required temperature. After equilibration, the HS-GC response measurement can be performed.

The sample amount/volume was optimized for the system of choice beforehand. This means that the amount of sorbent should capture a sufficiently large amount of gas from the headspace in comparison with the calibration curve at the same initial pressure, to produce reliable results above the uncertainty level of each data set. The optimal amount of sorbent was quickly determined by testing a range of quantities. For the systems chosen here, sample amounts between 3 and 10 mL for liquids were used. For example, for CO<sub>2</sub> experiments with liquid physisorbents, approximately 4.8 mL of sample was used, while 9.8 mL was necessary for CH<sub>4</sub> measurements. This difference is due to the large difference in solubility in the adsorbents tested (see Figure 4 and Supporting Information for

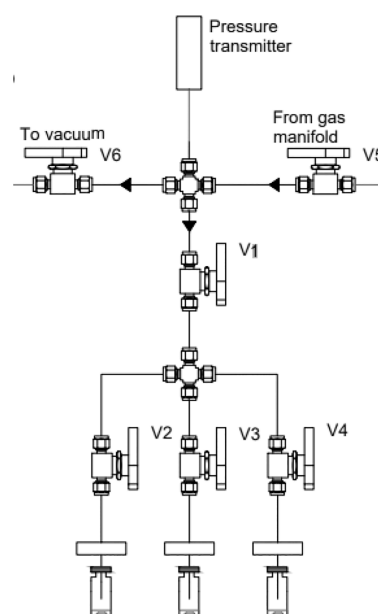

**Figure 2.** Schematic of the “trident” stainless-steel gas system setup used to produce three identical samples simultaneously, at the same initial gas pressure. V1–V6 represent Swagelok ball valves. The needles are represented piercing three sealed headspace gas chromatograph vials through gray butyl stoppers.

comparison). The porous solid sorbents used presented substantially higher gas uptake capacities per mass than the liquids; therefore, only approximately 0.5 g of solid was needed. A glass encased stir bar of approximately 0.2 mL was included in all liquid samples to promote faster equilibration times.

The quantity of gas sorbed is calculated using eq 1 from the difference between a pressure–volume–temperature (*pVT*) measurement and the GC peak area measurement. First, the amount of gas introduced in the vial,  $n_g^{\text{tot}}$ , is determined from the measurement of its pressure and estimated room temperature (initial pressure and temperature,  $p_{\text{ini}}$  and  $T_{\text{ini}}$ , respectively), in the predetermined vial volume,  $V_{\text{vial}}$ . This volume is obtained by measurement of the weight of distilled water filling a model vial, minus the volume of sorbent (if liquid), the volume of the glass encased stir bar, or glass beads present. For solid sorbents, the occupying volume was considered negligible.

$$n_g^{\text{tot}} = \frac{p_{\text{ini}}(V_{\text{ini}})}{(p_{\text{ini}}, T_{\text{ini}})RT_{\text{ini}}} \quad (1)$$

Deviations from ideal behavior for the gases were considered by the addition of compressibility factor to eq 1, however, the corrections were much smaller than the uncertainty associated with the measurements, even at the highest pressures, and so were neglected.

The GC sampling and measurement is performed after thermodynamic equilibrium is reached between the gas and the known quantity of predegassed sorbent. The amount of gas remaining in the headspace of the vial,  $n_g^{\text{HS}}$ , is calculated as

$$n_g^{\text{HS}} = \frac{p_{\text{eq}}(V_{\text{tot}} - V_{\text{vial}})}{(p_{\text{eq}}, T_{\text{eq}})RT_{\text{eq}}} \quad (2)$$

where  $p_{\text{eq}}$  and  $T_{\text{eq}}$  are the pressure and temperature at equilibrium. We considered that the volume of the liquid phase does not change after gas uptake and that the contribution to the partial pressure from the liquid sorbents was negligible at the temperatures considered. This means that the amount of sorbent,  $n_{\text{sorb}}$ , remains constant. These approximations are estimated to have a negligible effect on the accuracy of the gas absorption measurements within our estimated uncertainty levels.

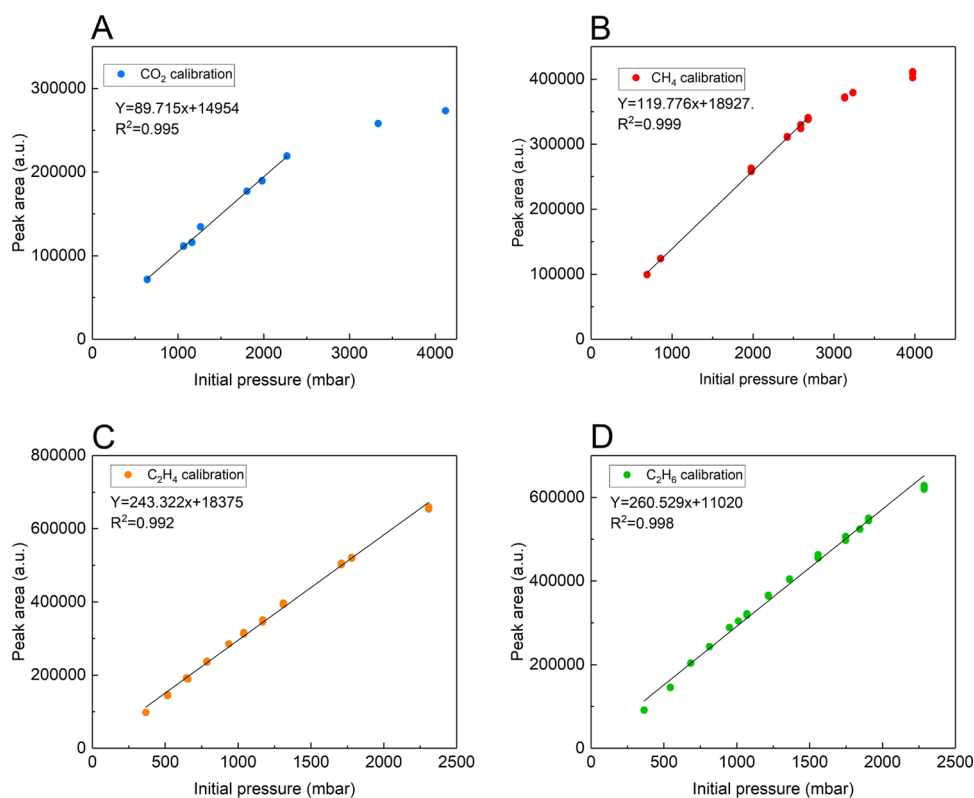

**Figure 3.** Response calibration profile for GC peak area to changes in initial gas partial pressure,  $p_{ini}$ , between 500–4000 mbar at 308 K for carbon dioxide (A, blue symbols, top left), methane (B, red symbols, top right), (C, orange symbols, bottom left), and ethane (D, green symbols, bottom right), with HS-GC vial occupied volume by glass beads of 5, 5, 3, and 3 mL, respectively. All data points were obtained in triplicate.

The pressure at equilibrium is estimated from the corresponding GC peak area, using the instrument response calibration curve as reference. The amount of gaseous solute sorbed by the sample,  $n_g^{sorb}$ , can then be determined from

$$n_g^{sorb} = n_g^{tot} - n_g^{HS} \quad (3)$$

For mixed gas solubility measurements, all pressures expressed correspond to partial pressures of the specified gas. In these cases, the equilibrium pressure,  $p_{eq}$  is determined by taking into account the total pressure obtained via HS-GC results and the molar proportion of the gas from the peak area fraction.

Gas solubility was expressed as the solute mole fraction ( $x_{gas}$ ) or sorbent capacity ( $C_{gas}$ ), calculated from the amount of gaseous solute absorbed by the sorbent, from eqs 4 and 5, respectively:

$$x_{gas} = \frac{n_g^{sorb}}{n_g^{sorb} + n_{sorb}} \quad (4)$$

The sorbent capacity is given by eq 5.

$$C_{gas} = \frac{m_g^{sorb}}{m_{sorb}} \quad (5)$$

where  $m_g^{sorb}$  is the mass of gas sorbed by the sorbent and  $m_{sorb}$  is the mass of sorbent.

For two gases (designated 1 and 2) the ideal gas separation selectivity ( $\alpha_i$ ) of a sorbent is given by the ratio of their respective solubilities, as exemplified in eq 6 for mole fraction solubilities

$$\alpha_i = \frac{x_1}{x_2} \quad (6)$$

or by the same mol/mass fraction ratio at the same equilibrium partial pressure and temperature. Real gas separation selectivity  $\alpha_r$  of the sorbents is directly determined from the gases' relative solubility (here

in mole fraction) in each sorbent via HS-GC mixed gas experiments, performed as described above and with a corresponding mixed gas calibration curve.

**Sample Pressurization.** HS-GC vials were loaded with a known amount of sorbent or glass beads, sealed with an autocrimper using a stopper and an aluminum crimp cap, placed on the “trident” gas system described in Figure 2, and purged under vacuum through the system's needles for either 3 or 15 min depending on the internal diameter of the needle used. A trio of closed vials can be placed in the trident and pressurized with the chosen gas/gas mixture simultaneously. This produces 3 vials at the same pressure, and a triplicate measurement.

The stainless-steel “trident” gas system was constructed to expedite sample preparation and is shown schematically in Figure 2. It consists of three male Luer lock fittings to 1/4 in. to 18 in. NPT thread fitting adapters (TSD931–1418MSS) supplied by Adhesive Dispensing. These were welded to a Swagelok tube fitting female connector, 1/4 in. tube OD  $\times$  1/4 in. female NPT to form a gastight seal. To each of the luer lock side a 10.5 mm  $\times$  20 G or a 51 mm  $\times$  23S G male luer lock needle in stainless steel with point style 2 was added, leaving a gastight seal. The internal diameter of the injection needles was selected to maximize the rate of gas flow in and out of the vials to minimize the time required to obtain the “initial pressure” measurement,  $p_{ini}$  (see eq 1), without generating leaks by compromising the integrity of the pierced septa. The 1/4 in. connection from the Swagelok adaptor was then fitted to the gas system via 1/4 in. pipe. Each trident head has its own ball valve (Swagelok SS-42GS4). The system is connected to a vacuum pump and gas regulators and the corresponding cylinders.

The pressure of the system was monitored by a Keller Pressure Series 33X pressure transmitter, operating between 0 and 6 bar absolute and with a precision of 0.001 bar. The bulk of the remainder of the system is built with Swagelok parts. This includes pipework (SS-T4-S-035–6ME, 1/4 in. OD  $\times$  0.035 in. wall thickness) and ball valves (SS-42GS4).

## RESULTS AND DISCUSSION

In the first instance, we produced calibration curves for CO<sub>2</sub>, CH<sub>4</sub>, C<sub>2</sub>H<sub>4</sub>, and C<sub>2</sub>H<sub>6</sub> and two of their mixtures, CO<sub>2</sub>/CH<sub>4</sub> and C<sub>2</sub>H<sub>4</sub>/C<sub>2</sub>H<sub>6</sub> (see data in [Supporting Information](#)). These correlated the pressure in the HS-GC vials to an integrated GC peak area. The calibrations were obtained for a variety of free vial volumes, between empty vials and vials occupied with 10 mL of glass beads, to match the volumes occupied by different types of sorbent samples. The HS-GC response to each gas was measured between pressures ranging from approximately 500 mbar to 4000 mbar at 308 K. A linear response range was obtained for pressures up to 2500 mbar and this correlation was used for the solubility measurements. A wide variety of gases (and gas mixtures) and sorbent materials was tested, from liquids to solids, physisorbents to chemisorbents, to demonstrate the versatility of the method.

**Detector Response and Calibration.** Empty vials or vials containing glass beads were filled with pure gas or a mixture of gases at a range of pressures between 500 and 4000 mbar, and their corresponding peak areas were measured via HS-GC. Each measurement was conducted in triplicate by loading three equivalent but independent vials on the “trident” gas system. Some of the GC integrated peak areas as a function of the initial gas pressure applied to the vials for CO<sub>2</sub>, CH<sub>4</sub>, C<sub>2</sub>H<sub>4</sub>, and C<sub>2</sub>H<sub>6</sub> gases are shown in [Figure 3](#). All raw data can be found in the [Supporting Information](#). Reasonable linearity was obtained for all gases and glass bead volumes up to a pressure of 2500 mbar, with *R*<sup>2</sup> values of greater than 0.99. Linear correlation fits, correlation coefficients (*R*<sup>2</sup>) and standard deviations for each system along with measurement repeatability assessments are reported in the [Supporting Information](#). This upper pressure range restriction is likely due to equipment limitations and could be extended if needed with different equipment and/or changes of the HS-GC method parameters.

We observed that the calibration curves for the same gas in vials with different free volumes presented small but consistent peak area differences. For example there was a 14% difference in the CO<sub>2</sub> calibration peak area when using 10 mL of glass beads when compared to using empty vials. For this reason, we have measured a range of calibration curves and use the closest one to the volume of sorbent for the required calculations. From these results we can also establish that small variations in liquid sample volume versus bead volume do lead to peak area variations, but we estimated these to be within the method's uncertainty. For solid sorbents, the sample volumes were so small that the corresponding calibration curves used for the calculations were measured by using empty HS-GC vials.

**Gas Uptake for Pure Gases.** Gas uptake into a series of sorbents was examined using the screening method developed, combining pressurization of gas over sorbents in HS-GC vials for pressures from 500–2500 mbar, and at 308 K, with direct sampling and gas analysis to determine partial pressures and compositions of the remaining, nonsorbed, gas.

A range of industrially and environmentally relevant permanent gases, CO<sub>2</sub>, CH<sub>4</sub>, C<sub>2</sub>H<sub>4</sub>, and C<sub>2</sub>H<sub>6</sub> have been examined, in addition to two 1:1 mol gas mixtures, CO<sub>2</sub>/CH<sub>4</sub> and C<sub>2</sub>H<sub>4</sub>/C<sub>2</sub>H<sub>6</sub>, to illustrate the potential to evaluate real gas separation selectivity  $\alpha_r$ . Gas sorption was screened using both solid and liquid sorbents that can take up specific gases through either chemisorption or physisorption mechanisms,

demonstrating the broad applicability of the methodology developed.

For materials with fast sorption kinetics such as porous solid sorbents and the aqueous MEA solution, the 20 G needle was used. In these cases 3 min of vacuum was applied. With volatile liquids, for example, aqueous MEA, the liquid was frozen using liquid nitrogen prior to evacuation and the weight of the sample after evacuation checked to ensure no significant sorbent loss. The contribution of the liquid to the final partial pressure of the headspace was estimated to be not significant within our estimated uncertainty. However, it is possible to take into account this contribution in the method's calculations when necessary. For low volatility liquid sorbents with high viscosities, such as ionic liquids, samples were initially kept under vacuum for up to 15 min to ensure thorough initial degassing that can be limited by mass transport.

After purging and evacuation, the vials containing sorbent are pressurized with the selected gas or gas mixtures to an “initial” pressure ( $p_{ini}$ ) measured by the pressure transmitter (see [Figures 1](#) and [2](#)). After the pressure in the vials stabilizes (15–50 s depending on the needle), they are immediately removed from the gas system.

For porous solid and chemisorbent materials (such as aqueous MEA), gas uptake kinetics are typically more rapid than those for liquid physisorbents, making it more difficult to estimate an “initial pressure” of the measurement vials. The combination of the right needle internal diameter and freezing of the liquid minimizes these difficulties. Furthermore, we compared the pressure obtained in calibration vials with the estimated pressure obtained in these samples in the exact same conditions, and the pressure variability falls within the method's usual range.

As the samples are equilibrated *ex situ* and not monitored during this period, it was crucial to determine the minimum equilibration time to ensure precise, consistent, and reproducible results. This was determined by producing samples in triplicate with periodic determination of the headspace peak area until a constant value was reached, *i.e.*, thermodynamic equilibrium was reached. For the materials described here, equilibration times varied between a few minutes and 5 days.

After measurement, sorbents with negligible volatility (solids and ionic liquids) could be regenerated by heating overnight at 40 °C under reduced pressure (100 mbar) in vented vials. Full regeneration was demonstrated by repeat gas loading with equivalent gas uptakes in subsequent measurements within the expected uncertainty.

We initially screened CO<sub>2</sub> and CH<sub>4</sub> uptake in a range of sorbents, along with C<sub>2</sub>H<sub>4</sub>/C<sub>2</sub>H<sub>6</sub> in a chemisorbent ionic liquid to validate the method. We chose six representatives of organic solvents: dimethyl sulfoxide, polyethylene glycol 200, glycerol, ethylene glycol, octanol, and sulfolane; two ionic liquids: [C<sub>4</sub>C<sub>1</sub>Im][NTf<sub>2</sub>] and [C<sub>6</sub>C<sub>1</sub>Im][NTf<sub>2</sub>]; a porous liquid (PL) formed by combination of Genosorb 1753 with 30 wt % zeolite RHO: two chemisorbent liquids: [C<sub>4</sub>C<sub>1</sub>Im][NTf<sub>2</sub>] containing 0.25 mol L<sup>-1</sup> Ag[NTf<sub>2</sub>], IL<sub>Ag</sub> (offering complexation to C<sub>2</sub>H<sub>4</sub>), 30 wt % aqueous methanolamine, MEA (a CO<sub>2</sub> chemisorbent), and solid 3 and 4 Å molecular sieves (MS3 and MS4, respectively) and zeolite RHO (PS) were investigated.

In this section, we present and discuss some of the CO<sub>2</sub> uptake measurements for the organic solvents and ionic liquid (see [Figure 4](#)). All data and remaining plots for other sorbents can be found in the [Supporting Information](#).



diverges from our data. However, the authors do not report the uncertainty associated with their measurements or the water content of the ionic liquid. It is also worth mentioning that these results were obtained from GC across an IL-packed column, while all the other referenced works are based in less intrusive volumetric or gravimetric techniques.

CO<sub>2</sub> uptake was then examined with high capacity solid sorbents (zeolite RHO and 4 Å molecular sieves), the porous liquid (zeolite RHO 25 wt % in Genosorb 1753) and chemisorbant 30 wt % aqueous monoethanolamine (MEA). The results and literature data taken under comparable conditions<sup>34</sup> are shown in Figure 6 shown as uptake capacities.

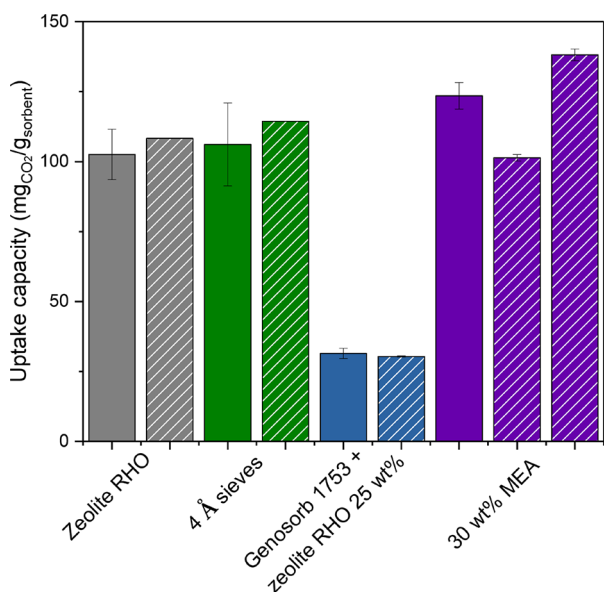

**Figure 6.** CO<sub>2</sub> sorption results, in mg of gas per g of sorbent, obtained from HS-GC method at 308 K (solid bars) and those published in the literature at 303 K (striped bars), at 1000 mbar, for selected solid sorbents,<sup>30</sup> a porous liquid,<sup>31</sup> and a 30% weight monoethanolamine aqueous solution (MEA).<sup>32,33</sup> Measurements were obtained with approximately 0.5 g of solid sorbents and 1 mL of liquid sorbents. Empty vials were used for the calibration curves. Error bars represent the average absolute deviation of the fit of the corresponding data.

A high uptake capacity for CO<sub>2</sub> was recorded for 30 wt % aqueous MEA (125 mg<sub>CO<sub>2</sub></sub>/g<sub>sorbent</sub>) which is intermediate between the various values reported in the literature.<sup>32,33</sup> High gas uptakes with zeolite RHO and 4 Å molecular sieves obtained were also consistent with reported values,<sup>30</sup> as were the results with the porous liquid (Genosorb 1753+zeolite RHO)<sup>31</sup> with capacity of approximately a quarter of that from the corresponding bulk zeolite which is consistent with gas absorption into the zeolite structure rather than in the polyethylene glycol dialkyl ether supporting liquid.

**Determination of Real Gas Selectivity.** An advantage of using HS-GC as a quantification method is that it allows for the separation and identification of multiple components in the headspace sample, something that is not frequently found in the relevant literature. Mixtures of gases can be used for the direct determination of the ability of a sorbent to capture specific gases from mixtures or in the presence of contaminants representing more realistic gas capture conditions. This is particularly important for systems where the competitive nature of gas sorption may lead to a selectivity different from that of the calculated ideal. Selectivity in gas mixtures was

examined for two exemplar systems of interest, CO<sub>2</sub> and CH<sub>4</sub> and C<sub>2</sub>H<sub>4</sub> and C<sub>2</sub>H<sub>6</sub>, using sulfolane and a silver salt containing ionic liquid, respectively, to demonstrate applicability for a range of gas separation challenges.

In Figure 7, we can see the data obtained for the CO<sub>2</sub> uptake capacity with sulfolane, with both pure CO<sub>2</sub> and its 1:1 molar

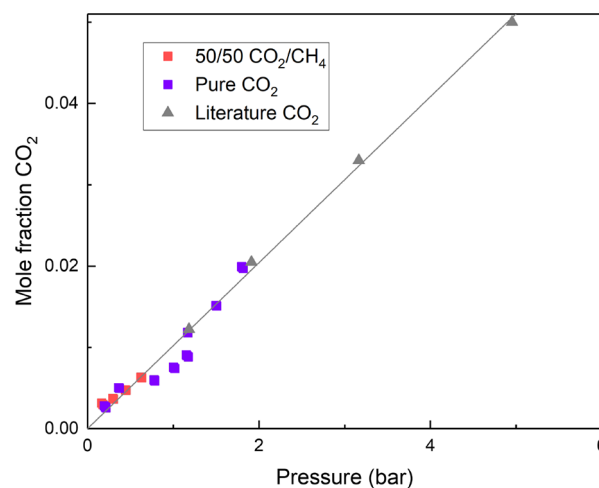

**Figure 7.** CO<sub>2</sub> mole fraction solubility in sulfolane at pressures between 1 and 5 bar. Results from this work (square symbols) obtained with pure CO<sub>2</sub> (purple) and 1:1 molar CO<sub>2</sub>/CH<sub>4</sub> gas mixture (red) are represented along with the literature (gray triangles - pure CO<sub>2</sub>).<sup>20</sup> Results obtained using the screening method were carried out at partial pressures of CO<sub>2</sub> between 200 and 2000 mbar at 308 K using 5 mL of HS-GC occupied volume. Literature results at 303 K.

mixture with CH<sub>4</sub>. These results are compared with the literature data for pure CO<sub>2</sub> uptake.<sup>20</sup>

We observe that as expected for a physisorbant such as sulfolane, the impact of using a gas mixture instead of a pure gas steam is minimal, particularly at such low pressures. Similar experiments were carried to determine the C<sub>2</sub>H<sub>4</sub> and C<sub>2</sub>H<sub>6</sub> pure and mixed gas solubility in [C<sub>4</sub>C<sub>1</sub>Im][NTf<sub>2</sub>] ionic liquid containing 0.25 mol L<sup>-1</sup> concentration of Ag[NTf<sub>2</sub>]. The results are presented in Figure 8 for a range of pressures. As expected, since the major source of ethylene uptake capacity is through complexation with silver, there is no competitive mechanism for the absorption, leading to almost identical uptake capacities for both gases in both cases.

We then compared these results with the absorption of the pure gases in the ionic liquid before the silver addition (Figure 9) at 1000 mbar and 308 K. The results show similar and relatively low absorption of both gases in the pure ionic liquid, and a 5-fold increase in ethylene uptake, and selectivity from approximately 1.3 to 8.2 upon addition of silver salt to the sorbent. These results are in good agreement with literature where ideal selectivity values increased by almost 8-fold, from approximately 1.37 to 10.7 for the same chemisorbant ionic liquid at the same silver salt concentration and 560 mbar ethylene pressure at 303 K.<sup>35</sup>

The real selectivity obtained, 9.2, is close to the ideal selectivity described in the literature and those obtained from our own results, as expected for these systems in mild conditions.

**Sources of Error and Method Limitations.** Several possible sources of error were identified in association with the



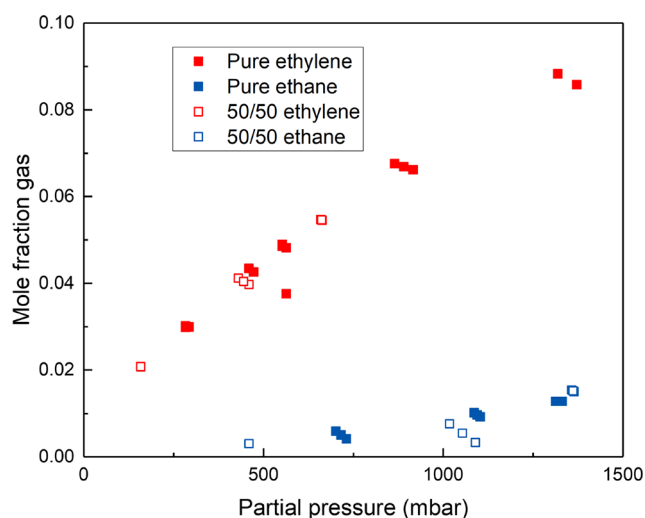

**Figure 8.** Ethylene,  $C_2H_4$  (red squares), and ethane  $C_2H_6$  (blue squares) mole fraction solubility in the ionic liquid  $[C_4C_1Im][NTf_2]$  containing  $0.25 \text{ mol L}^{-1}$  concentration of  $Ag[NTf_2]$  at pressures/partial pressures between 200 mbar and 1500 mbar obtained using the HS-GC method, at 308 K. Measurements were carried out using both pure gases (solid symbols) and 50/50 mixed gases (empty symbols). All measurements were performed using 3 mL of HS-GC vial occupied volume.

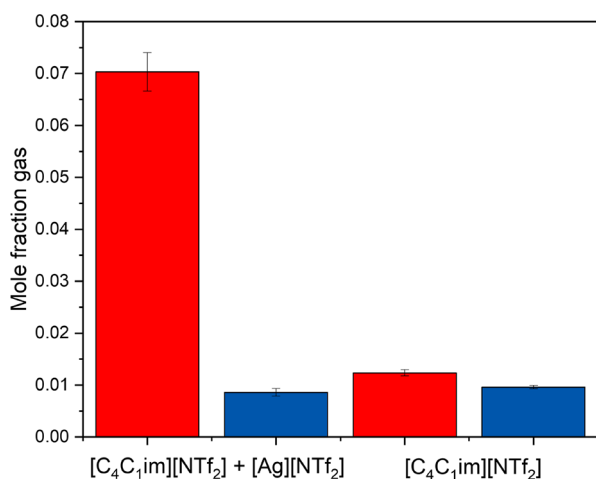

**Figure 9.**  $C_2H_6$  (blue bars) and  $C_2H_4$  (red bars) pure gas absorption results, in gas mole fraction, obtained from the HS-GC screening method at 308 K (solid bars) at 1000 mbar, for pure  $[C_4C_1Im][NTf_2]$  (right), and for  $[C_4C_1Im][NTf_2] + Ag[NTf_2]$  (left) for a silver concentration of  $0.25 \text{ mol L}^{-1}$ . Measurements/calibration were performed using 3 mL of sorbent/glass beads. Error bars represent the average absolute deviation of the fit of the corresponding data.

method. The most relevant is likely the temperature control. As the samples vials are being pressurized, they are conditioned at room temperature, which is subject to variation. After equilibration at controlled temperature, the vials are transferred to the HS-GC at room temperature and equilibrated again in the HS-GC oven (with no stirring) at controlled temperature for 2 h. These temperature variations justify, at least in part, both the dispersion and deviation of our measures relative to those in the known literature. As expected, the dispersion of the data in the calibration curve and isotherms leads to error propagation within our calculations. Other smaller sources of error can come from variations in the HS-

GC vial volume and variations in the glass beads and stir bar volumes.

The level of uncertainty that we report is sufficient for a clear comparison and ranking even between materials within the same range of gas solubilities. The goal of this screening method is to streamline the selection and testing of materials for gas capture and separation, saving resources and research time. It was not designed to produce high accuracy results, and although implementing further steps to increase its precision and accuracy could be taken, it would certainly negatively affect its throughput.

We estimate that the minimum pressure variation in the HS-GC vials that can be used with this method should be above 65–70 mbar, corresponding to the uptake of approximately a minimum of 0.04 mmol or 1.8 mg of  $CO_2$ . For the ionic liquid  $[C_6C_1Im][NTf_2]$ , as an example, this corresponds to a lower mole fraction of 0.0027. This estimation is based on the minimum pressure difference needed between the calibration curve and measurement to obtain a reliable and reproducible result, above the corresponding average absolute deviations.

The results obtained with the least amount of uncertainty were, as expected, for materials with high gas uptake, since a larger difference between the calibration curve and the measurement leads to a more reliable result. For materials with low gas uptake, we recommend increasing the amount of sorbent, increasing the initial gas pressure, and/or miniaturizing the procedure with 10 mL HS-GC vials.

Since this method is based on HS-GC it shares its limitations. Certain gases or mixtures might be too complex to analyze, notoriously mixtures with  $SO_2$ , other very reactive gases, or impurities that may react with GC internal parts or that easily degrade at the GC internal temperatures. Some gas mixtures may call for the use of 2 columns or a variety of GC detectors. However, the usual GC detectors present wide gas detection range and detection limits well below the concentrations used in this method.

Although the HS-GC vials used here are rated for 5 bar, for safety reasons, we do not recommend using pressures well above atmospheric if not necessary and never with nonspecked vials. The transportation of glass vials under the higher pressure range, particularly containing glass beads, should be done with particular care.

**Advantages and Benefits.** Traditional gravimetric or volumetric methods or even a Brunauer–Emmett–Teller (BET) analysis requires between 1 day and 1 week per measurement per sample. As in the methods above, the slow step in this method remains the equilibration time of the gas with the sorbent, representing a few minutes for some microporous solids up to 5 days with viscous ionic liquids. However, by offering *ex situ* equilibration, we bypass this challenge, allowing for the production of one set of triplicate samples every 5–15 min. This means that a long equilibration time for one sample does not impact the production or analysis of others.

Considering the 3–15 min of vacuum applied before the sample pressurization and 1 min of pressurization, we can produce between 30 and 96 triplicate samples per day, the lower limitation being the slow vacuum stage that was expedited with the wider trident needles. If only single measurements are required, then between 90 and 264 different sorbents can be tested in the same amount of time. This estimate takes into account the 2 h equilibration time in the GC oven and a 5 min GC analysis run. From this we estimate a

90–3000 times reduction in the time required for equivalent analysis.

An additional benefit is that the method is adaptable to a range of uptake capacities and a wide variety of materials, solids and liquids, volatile and nonvolatile, and chemisorbent and physisorbent.

We can simultaneously and directly screen the sorbents for their gas separation ability by using gas mixtures. This is highly relevant for materials that, for example, contain metal sites that may interact with different gases in the mixture, such as MOFs and many porous liquids or other chemisorbent materials.

Finally, one additional benefit of this method is that it does not require specialized equipment, since a HS-GC is frequently present in research and industrial laboratories, opening the screening of materials for gas uptake and separation for a wide range of research(ers).

## CONCLUSIONS

We have developed a high-throughput gas uptake screening approach suitable for liquid and solid sorbents that is based on headspace gas chromatography. We have proven that this universal method can be applied with pure and mixed gas feeds for fast, universal experimental screening of gas uptake and determination of real gas separation selectivities across a range of pressures and temperatures. This method allows for screening of both solid and liquid materials, volatile or nonvolatile, physisorbent or chemisorbent, combined with pure or mixed gas streams. As an example, we can adequately detect CO<sub>2</sub> sorption for a minimum gas uptake of 0.0027 in mole fraction in [C<sub>6</sub>C<sub>1</sub>Im][NTf<sub>2</sub>]. This universal method is also adaptable to a wide range of gas uptake capacities, and although the slowest step in the process remains the equilibration, the ability to “number up” samples for off-line equilibration overcomes this restriction, allowing for the screening of up to 264 different sorbents per day. Other gases of relevance can be studied using this technique, such as NH<sub>3</sub>, H<sub>2</sub>, and SO<sub>2</sub>, although some may require more specialized gas chromatography analytics than a standard FID detector. For example, we have extended this experimental methodology to H<sub>2</sub> quantification, which should soon follow this publication.

## ASSOCIATED CONTENT

### Supporting Information

The Supporting Information is available free of charge at <https://pubs.acs.org/doi/10.1021/acssuschemeng.3c05901>.

Experimental data on gas sorption measurements, HS-GC calibration curves and characterization data (PDF)

## AUTHOR INFORMATION

### Corresponding Author

Leila Moura – QUILL Research Centre, Queen's University Belfast, School of Chemistry and Chemical Engineering, David Keir Building, Belfast BT9 5AG, United Kingdom; [orcid.org/0000-0002-7938-5892](https://orcid.org/0000-0002-7938-5892); Email: [l.moura@qub.ac.uk](mailto:l.moura@qub.ac.uk)

### Authors

J. Mark Young – QUILL Research Centre, Queen's University Belfast, School of Chemistry and Chemical Engineering, David Keir Building, Belfast BT9 5AG, United Kingdom; [orcid.org/0000-0002-3757-453X](https://orcid.org/0000-0002-3757-453X)

Sam H. McCalmont – QUILL Research Centre, Queen's University Belfast, School of Chemistry and Chemical Engineering, David Keir Building, Belfast BT9 5AG, United Kingdom; [orcid.org/0000-0002-9744-9642](https://orcid.org/0000-0002-9744-9642)

Sophie Fourmentin – Unité de Chimie Environnementale et Interactions sur le Vivant (UCEIV), EA 4492, Condorcet FR CNRS 3417, Université du Littoral-Côte d'Opale, 59140 Dunkerque, France; [orcid.org/0000-0002-4334-0051](https://orcid.org/0000-0002-4334-0051)

Panagiotis Manesiotes – Queen's University Belfast, School of Chemistry and Chemical Engineering, David Keir Building, Belfast BT9 5AG, United Kingdom; [orcid.org/0000-0001-6107-8782](https://orcid.org/0000-0001-6107-8782)

John D. Holbrey – QUILL Research Centre, Queen's University Belfast, School of Chemistry and Chemical Engineering, David Keir Building, Belfast BT9 5AG, United Kingdom; [orcid.org/0000-0002-3084-8438](https://orcid.org/0000-0002-3084-8438)

Complete contact information is available at:

<https://pubs.acs.org/10.1021/acssuschemeng.3c05901>

## Notes

The authors declare no competing financial interest.

## ACKNOWLEDGMENTS

The authors thank Professor Stuart James (QUB), Professor Gosia Swadźba-Kwaśny (QUILL, QUB) and Dr. Peter Klusener (SHELL) for their support and feedback on experiments and manuscript. The authors acknowledge the support and materials supplied by QUILL, Dr. Beibei Lai (QUB), and Porous Liquids Technologies towards this project. L.M. acknowledges the support from the Royal Academy of Engineering in the form of the Research Fellowship RF\0201718\17111. J.M.Y. thanks the EPSRC for his Standard Research Studentship ref 2442987. S.McC. thanks the EPSRC for his Standard Research Studentship ref 2374580. The authors acknowledge the Royal Society and the Royal Society of Chemistry for financial support in the form of a Royal Society Research Grants, grant code RGS\R1\211263, a Royal Society of Chemistry Research Fund grant, code R20-9067 and the Alliance Hubert Curien programme grants 815546116 and 47838XD. Finally the authors thank Agilent engineers Bryan White and Michael Crean for help with troubleshooting on the method development and sanity check on the HS-GC equipment.

## REFERENCES

- (1) Fu, D.; Davis, M. E. Carbon dioxide capture with zeotype materials. *Chem. Soc. Rev.* **2022**, *51*, 9340–9370.
- (2) Jia, T.; Gu, Y.; Li, F. Progress and potential of metal-organic frameworks (MOFs) for gas storage and separation: A review. *J. Environ. Chem. Eng.* **2022**, *10*, 108300.
- (3) Li, G.; Chen, K.; Lei, Z.; Wei, Z. Condensable Gases Capture with Ionic Liquids. *Chem. Rev.* **2023**, *123*, 10258–10301.
- (4) Moura, L.; Kollau, L.; Costa Gomes, M. In *Deep Eutectic Solvents for Medicine, Gas Solubilization and Extraction of Natural Substances*; Fourmentin, S., Costa Gomes, M., Lichtfouse, E., Eds.; Springer International Publishing, 2021; pp 131–155.
- (5) Egleston, B. D.; Mroz, A.; Jelfs, K. E.; Greenaway, R. L. Porous liquids – the future is looking emptier. *Chem. Sci.* **2022**, *13*, 5042–5054.
- (6) Dohrn, R.; Fonseca, J. M.; Peper, S. Experimental Methods for Phase Equilibria at High Pressures. *Annu. Rev. Chem. Biomol. Eng.* **2012**, *3*, 343–367.
- (7) McCalmont, S. H.; Vaz, I. C. M.; Oorts, H.; Gong, Z.; Moura, L.; Costa Gomes, M. Insights into the Absorption of Hydrocarbon Gases

- in Phosphorus-Containing Ionic Liquids. *J. Phys. Chem. B* **2023**, *127*, 3402–3415.
- (8) Yim, J.-H.; Song, H. N.; Yoo, K.-P.; Lim, J. S. Measurement of CO<sub>2</sub> Solubility in Ionic Liquids: [BMP][Tf<sub>2</sub>N] and [BMP][MeSO<sub>4</sub>] by Measuring Bubble-Point Pressure. *J. Chem. Eng. Data* **2011**, *56*, 1197–1203.
- (9) Shiflett, M. B.; Maginn, E. J. The solubility of gases in ionic liquids. *AIChE J.* **2017**, *63*, 4722–4737.
- (10) Huang, J.; Riisager, A.; Berg, R. W.; Fehrmann, R. Tuning ionic liquids for high gas solubility and reversible gas sorption. *J. Mol. Catal. A: Chem.* **2008**, *279*, 170–176.
- (11) Song, T.; Lubben, M. J.; Brennecke, J. F. Solubility of argon, krypton and xenon in ionic liquids. *Fluid Phase Equilib.* **2020**, *504*, 112334.
- (12) Lin, R.-B.; Wu, H.; Li, L.; Tang, X.-L.; Li, Z.; Gao, J.; Cui, H.; Zhou, W.; Chen, B. Boosting Ethane/Ethylene Separation within Isoreticular Ultramicroporous Metal–Organic Frameworks. *J. Am. Chem. Soc.* **2018**, *140*, 12940–12946.
- (13) Corvo, M. C.; Sardinha, J.; Menezes, S. C.; Einloft, S.; Seferin, M.; Dupont, J.; Casimiro, T.; Cabrita, E. J. Solvation of Carbon Dioxide in [C<sub>4</sub>mim][BF<sub>4</sub>] and [C<sub>4</sub>mim][PF<sub>6</sub>] Ionic Liquids Revealed by High-Pressure NMR Spectroscopy. *Angew. Chem.* **2013**, *125*, 13262–13265.
- (14) Heintz, A.; Kulikov, D. V.; Verevkin, S. P. Thermodynamic Properties of Mixtures Containing Ionic Liquids. 1. Activity Coefficients at Infinite Dilution of Alkanes, Alkenes, and Alkylbenzenes in 4-Methyl-n-butylpyridinium Tetrafluoroborate Using Gas Liquid Chromatography. *J. Chem. Eng. Data* **2001**, *46*, 1526–1529.
- (15) Zhang, J.; Zhang, Q.; Qiao, B.; Deng, Y. Solubilities of the Gaseous and Liquid Solutes and Their Thermodynamics of Solubilization in the Novel Room-Temperature Ionic Liquids at Infinite Dilution by Gas Chromatography. *J. Chem. Eng. Data* **2007**, *52*, 2277–2283.
- (16) Bourland, K. R.; Morales-Collazo, O.; Brennecke, J. F. Inverse Gas Chromatography as a Screening Technique for Henry's Law Constants of Gases in Ionic Liquids. *J. Chem. Eng. Data* **2022**, *67*, 385–392.
- (17) Shaahmadi, F.; Hashemi Shahraki, B.; Farhadi, A. The CO<sub>2</sub>/CH<sub>4</sub> gas mixture solubility in ionic liquids [Bmim][Ac], [Bmim]-[BF<sub>4</sub>] and their binary mixtures. *J. Chem. Thermodynamics* **2020**, *141*, 105922.
- (18) Shiflett, M. B.; Yokozeki, A. Separation of Carbon Dioxide and Sulfur Dioxide Using Room-Temperature Ionic Liquid [bmim]-[MeSO<sub>4</sub>]. *Energy Fuels* **2010**, *24*, 1001–1008.
- (19) Kordikowski, A.; Schenk, A.; Van Nielen, R.; Peters, C. Volume expansions and vapor-liquid equilibria of binary mixtures of a variety of polar solvents and certain near-critical solvents. *J. Supercrit. Fluids* **1995**, *8*, 205–216.
- (20) Jalili, A. H.; Shokouhi, M.; Samani, F.; Hosseini-Jenab, M. Measuring the solubility of CO<sub>2</sub> and H<sub>2</sub>S in sulfolane and the density and viscosity of saturated liquid binary mixtures of (sulfolane+CO<sub>2</sub>) and (sulfolane+H<sub>2</sub>S). *J. Chem. Thermodynamics* **2015**, *85*, 13–25.
- (21) Fogg, P. G. In *Carbon Dioxide in Non-Aqueous Solvents at Pressures less than 200 kPa*; Fogg, P. G., Ed.; Pergamon Press, 1992.
- (22) Nunes, A. V.M.; Carrera, G. V.S.M.; Najdanovic-Visak, V.; Nunes da Ponte, M. Solubility of CO<sub>2</sub> in glycerol at high pressures. *Fluid Phase Equilib.* **2013**, *358*, 105–107.
- (23) Li, J.; Ye, Y.; Chen, L.; Qi, Z. Solubilities of CO<sub>2</sub> in Poly(ethylene glycols) from (303.15 to 333.15) K. *J. Chem. Eng. Data* **2012**, *57*, 610–616.
- (24) Böttger, A.; Pérez-Salado Kamps, Á.; Maurer, G. An experimental investigation on the solubility of methane in 1-octanol and n-dodecane at ambient temperatures. *Fluid Phase Equilib.* **2016**, *427*, 566–574.
- (25) Kumelan, J.; Pérez-Salado Kamps, Á.; Tuma, D.; Maurer, G. Solubility of the single gases methane and xenon in the ionic liquid [hmim][Tf<sub>2</sub>N]. *Ind. Eng. Chem. Res.* **2007**, *46*, 8236–8240.
- (26) Galvão, A.; Francesconi, A. Solubility of methane and carbon dioxide in ethylene glycol at pressures up to 14 MPa and temperatures ranging from (303 to 423) K. *J. Chem. Thermodynamics* **2010**, *42*, 684–688.
- (27) Costa Gomes, M. F. Low-pressure solubility and thermodynamics of solvation of carbon dioxide, ethane, and hydrogen in 1-hexyl-3-methylimidazolium bis(trifluoromethylsulfonyl) amide between temperatures of 283 K and 343 K. *J. Chem. Eng. Data* **2007**, *52*, 472–475.
- (28) Décultot, M.; Ledoux, A.; Fournier-Salaün, M.-C.; Estel, L. Solubility of CO<sub>2</sub> in methanol, ethanol, 1, 2-propanediol and glycerol from 283.15 K to 373.15 K and up to 6.0 MPa. *J. Chem. Thermodynamics* **2019**, *138*, 67–77.
- (29) Zhang, J.; Zhang, Q.; Qiao, B.; Deng, Y. Solubilities of the Gaseous and Liquid Solutes and Their Thermodynamics of Solubilization in the Novel Room-Temperature Ionic Liquids at Infinite Dilution by Gas Chromatography. *J. Chem. Eng. Data* **2007**, *52*, 2277–2283.
- (30) Siriwardane, R. V.; Shen, M.-S.; Fisher, E. P.; Poston, J. A. Adsorption of CO<sub>2</sub> on molecular sieves and activated carbon. *Energy Fuels* **2001**, *15*, 279–284.
- (31) Tsang, M. Y.; Convery, J. P.; Lai, B.; Cahir, J.; Erbay, Y.; Rooney, D.; Murrer, B.; James, S. L. Porous liquids as solvents for the economical separation of carbon dioxide from methane. *Mater. Today* **2022**, *60*, 9–16.
- (32) Kim, Y. E.; Lim, J. A.; Jeong, S. K.; Yoon, Y. I.; Bae, S. T.; Nam, S. C. Comparison of carbon dioxide absorption in aqueous MEA, DEA, TEA, and AMP solutions. *Bull. Korean Chem. Soc.* **2013**, *34*, 783–787.
- (33) Tong, D.; Trusler, J. M.; Maitland, G. C.; Gibbins, J.; Fennell, P. S. Solubility of carbon dioxide in aqueous solution of monoethanolamine or 2-amino-2-methyl-1-propanol: Experimental measurements and modelling. *Int. J. Greenhouse Gas Control* **2012**, *6*, 37–47.
- (34) Lv, B.; Guo, B.; Zhou, Z.; Jing, G. Mechanisms of CO<sub>2</sub> capture into monoethanolamine solution with different CO<sub>2</sub> loading during the absorption/desorption processes. *Environ. Sci. Technol.* **2015**, *49*, 10728–10735.
- (35) Xing, H.; Zhao, X.; Li, R.; Yang, Q.; Su, B.; Bao, Z.; Yang, Y.; Ren, Q. Improved efficiency of ethylene/ethane separation using a symmetrical dual nitrile-functionalized ionic liquid. *ACS Sus. Chem. Eng.* **2013**, *1*, 1357–1363.