

3D-AFM: A new technique for the characterization of solid/liquid interfaces

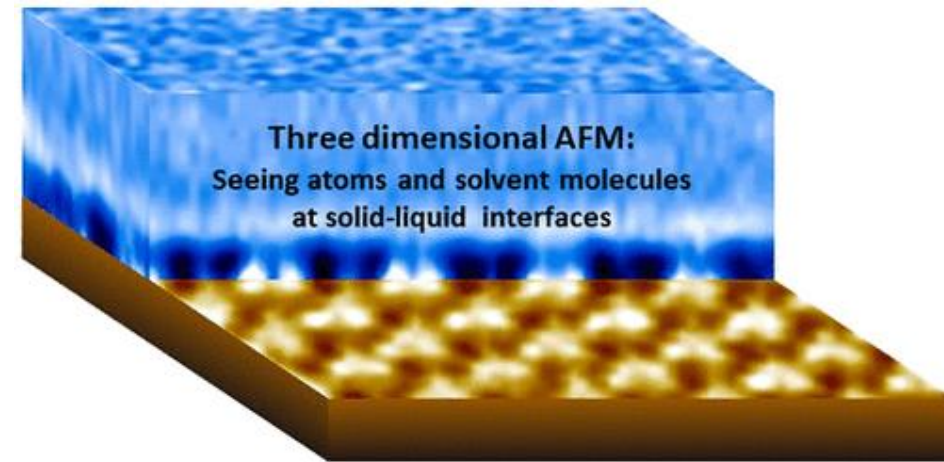
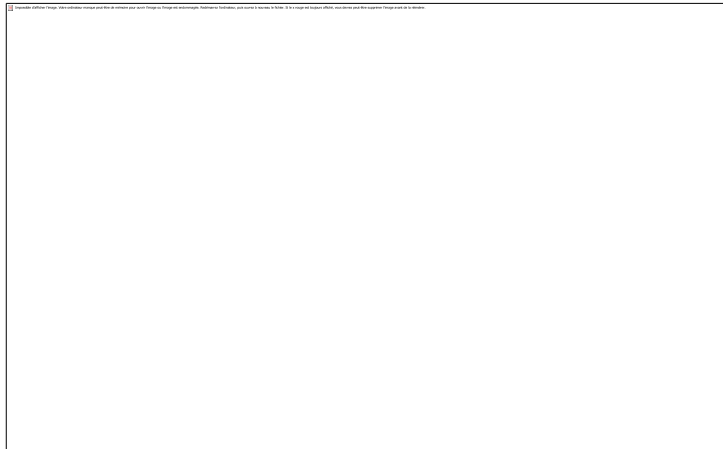

Takeshi Fukuma and Ricardo Garcia *ACS Nano* **2018** 12 (12), 11785-11797

Presented by Dahlia SAAD

Directed by Prof Magali PHANER-GOUTORBE (INL) & Dr Frederic DUBREUIL (LTDS)

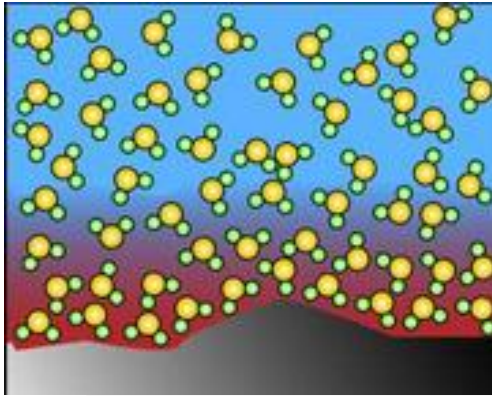

bulk liquid

Liquid molecules

interfacial liquid

solid

- Thin film growth in the liquid phase
- Catalysis reactions
- Bio recognitions on biosensors
- Movements of molecules
- Tribology

Voitchovsky, Kison & Ricci, Maria. (2012). Proceedings of SPIE. 8232. 14

1D-AFM or Force spectroscopy

Point by Point force curves

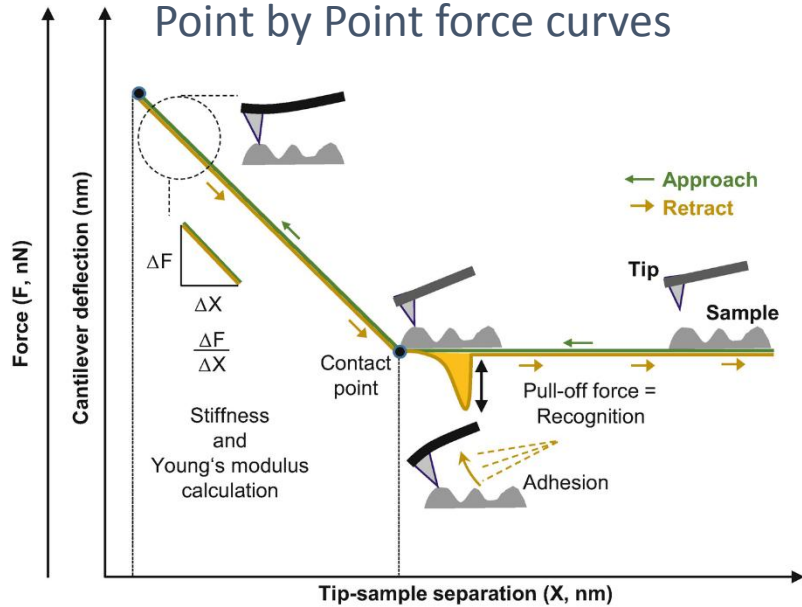

Liashkovich, I., Rosso, G., Shahin, V. (2022). In: Goldberg, M.W. (eds) The Nuclear Pore Complex. Methods in Molecular Biology, vol 2502. Humana, New York, NY.

3D-AFM

3D force maps

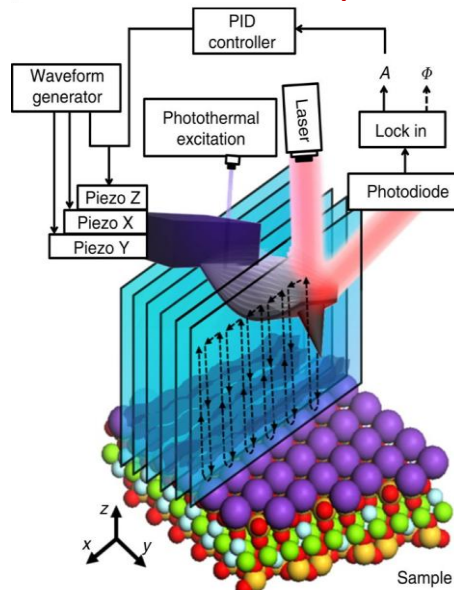

Martin-Jimenez, D. et al. Nat. Commun. 7:12164

2D-AFM or Imaging

Topography & material properties

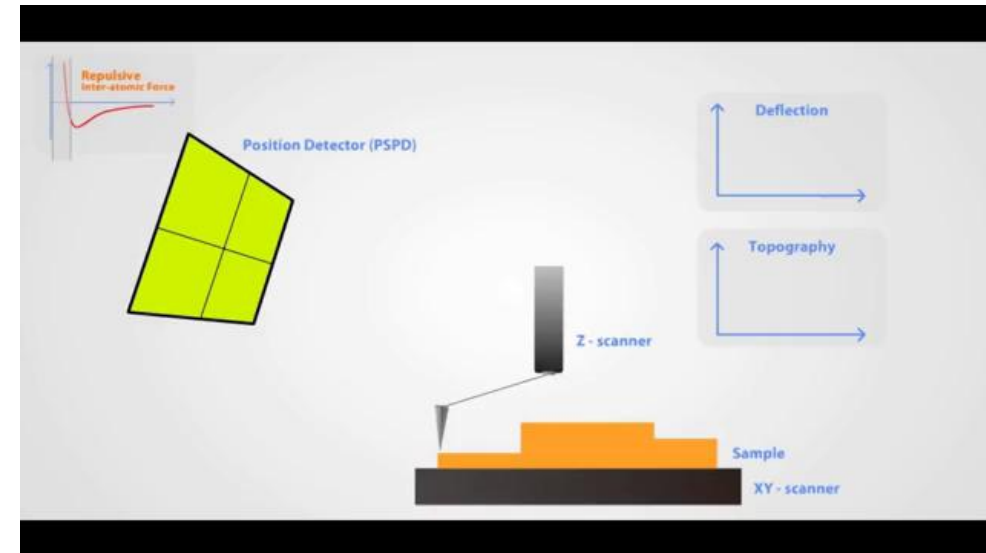

Reproduced from Nisenet, 2017

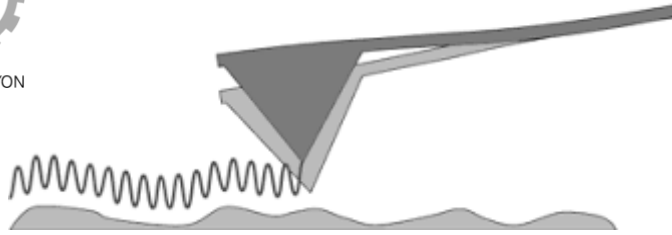

2D-AFM

Dynamic Mode

Excited cantilever

Contact Mode

Static cantilever

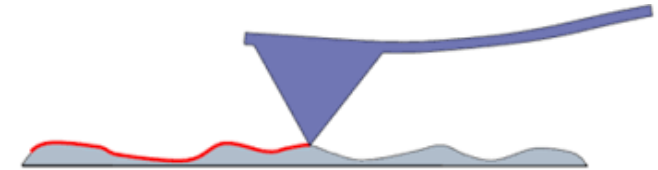

Amplitude Modulation-AFM

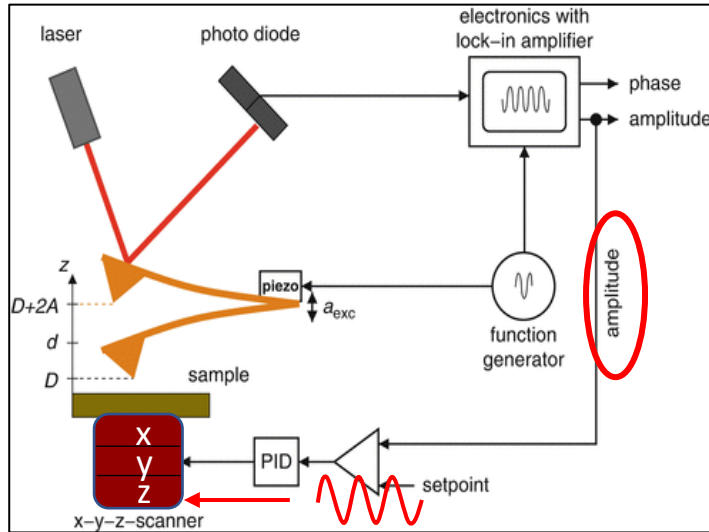

Hölscher, H. (2012). AFM, Tapping Mode. In: Bhushan, B. (eds) Encyclopedia of Nanotechnology. Springer, Dordrecht. [modified]

Frequency Modulation-AFM

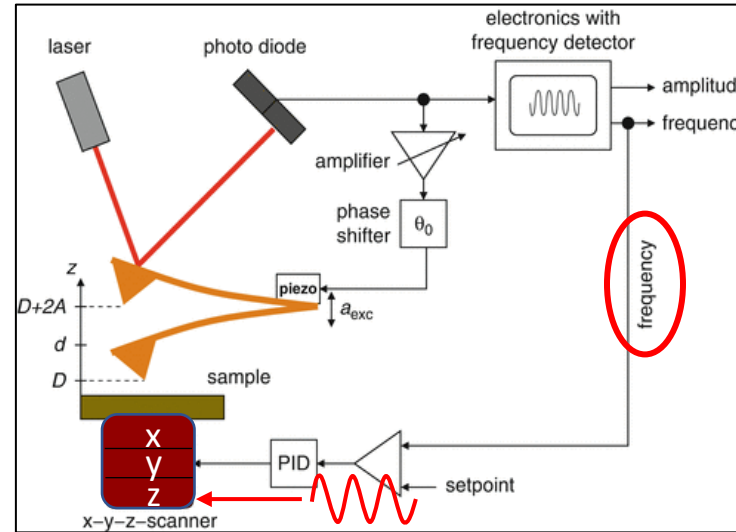

Hölscher, H. (2012). AFM, Non-contact Mode. In: Bhushan, B. (eds) Encyclopedia of Nanotechnology. Springer, Dordrecht [modified]

Bimodal-AFM

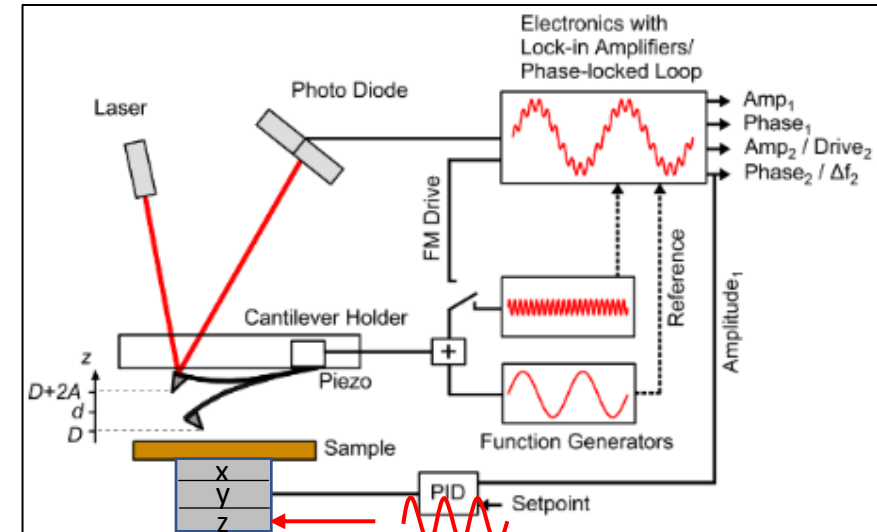

Beilstein J. Nanotechnol. 2013, 4, 198–207

3D-AFM

- Feedback loop system same as 2D-AFM
- External sinusoidal signal on z piezo faster than the feedback bandwidth

3D images of Interfaces



Force volume mapping

- Slow scanning speed
- Resolution
- Drift during scan

- $\Delta f/d$ curves at different (xy) positions
- 2D (xy) images at different z offsets



Calcite-water interface

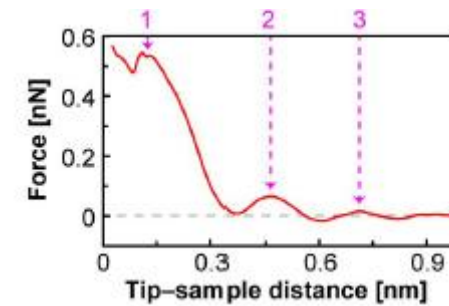
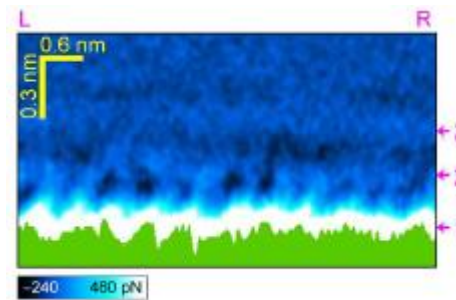
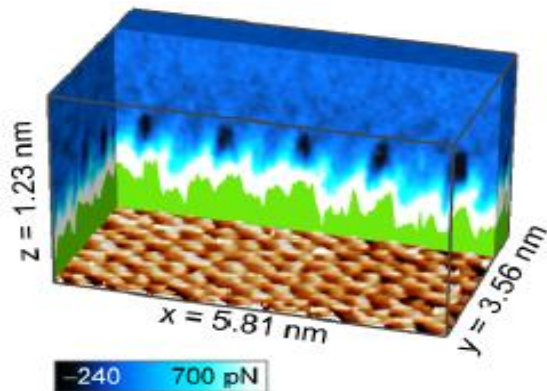

3D images of Interfaces

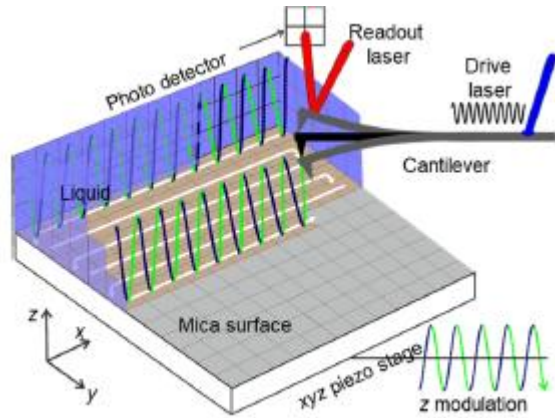

J. Hernández-Muñoz, M. R. Uhlig, S. Benaglia, E. Chacón, P. Tarazona, and R. Garcia
The Journal of Physical Chemistry C **2020** 124 (48), 26296-26303



3D-AFM

Fast scanning speed

Higher resolution

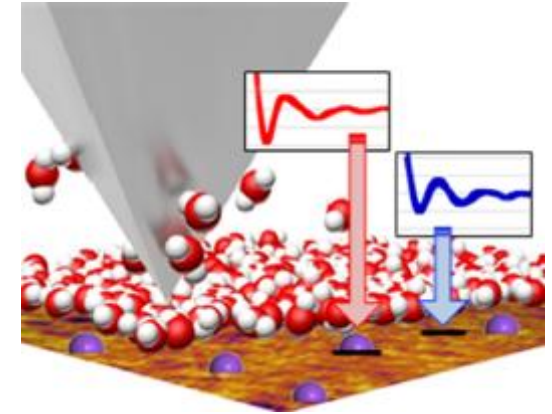

Daniel Martin-Jimenez and Ricardo Garcia
The Journal of Physical Chemistry Letters **2017** 8 (23), 5707-5711

Mica-KCl interface

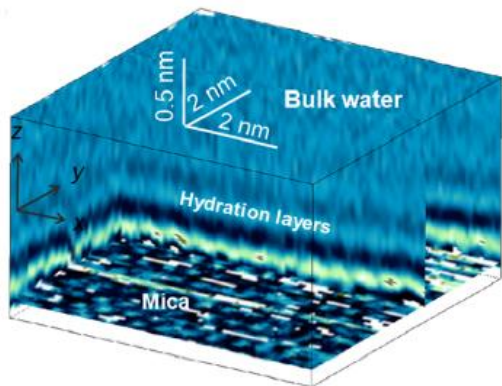

Mica-KCl interface

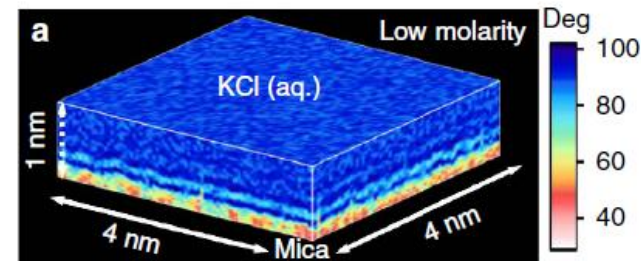
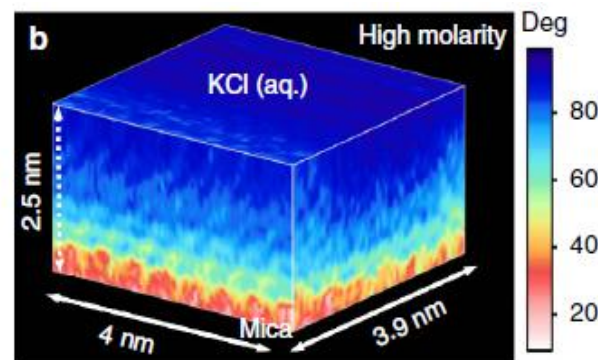

Graphite-water interface

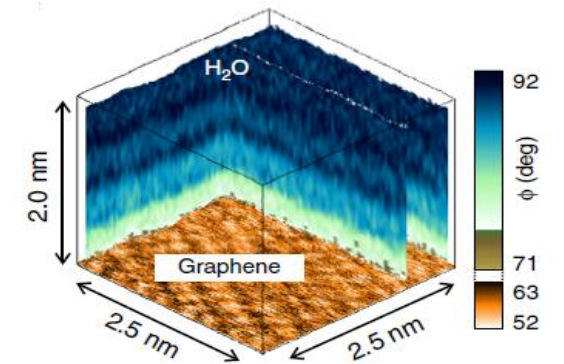

Uhlig, M.R., Martin-Jimenez, D. & Garcia, R.
 (2019) *Nat Commun* **10**, 2606

Complicated interfaces

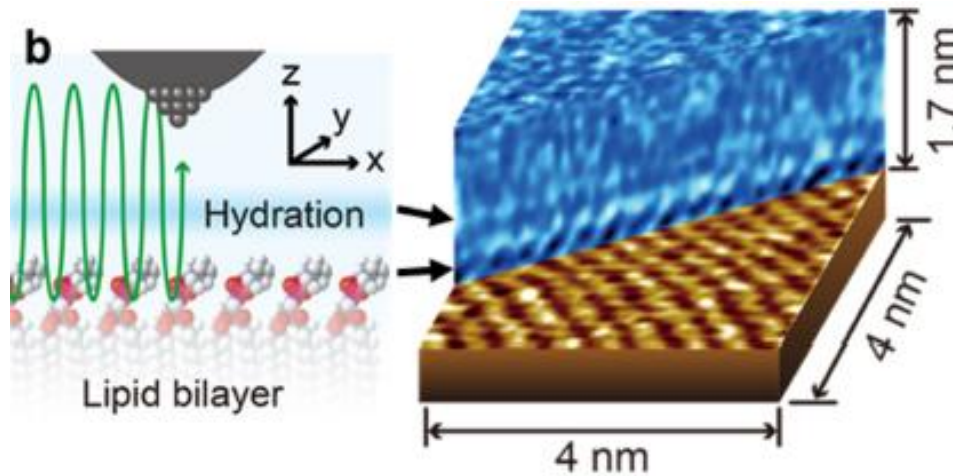

Asakawa *et al.* (2012). ASCNano vol. 6. no. 10. 9013-9020

Objective

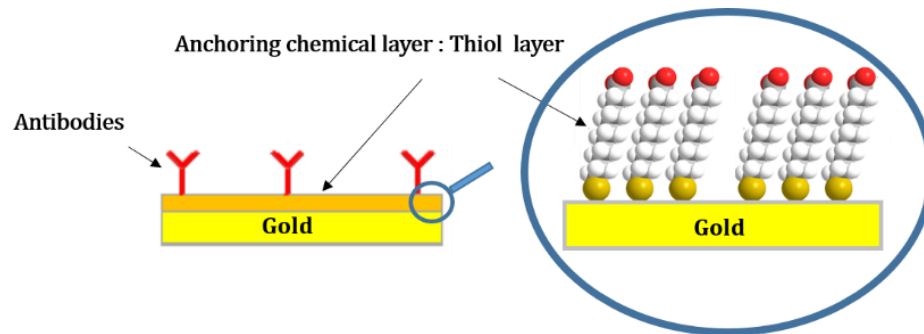

Liquid/Organic layer/Solid

Biosensors (INL)

Tribology (LTDS)

Samples

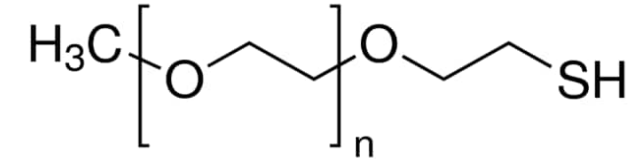
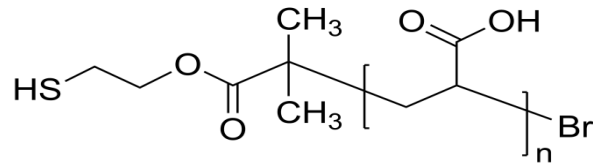

Poly(acrylic acid), (α -thiol, ω -bromo)-terminated

PAA

Mn = 2000

Mw = 2600

Poly(ethylene glycol) methyl ether thiol

PEG/PEO

$\text{CH}_3\text{O}(\text{CH}_2\text{CH}_2\text{O})_n\text{CH}_2\text{CH}_2\text{SH}$

Average Mn = 2000

C = 1,5 g/L
4 hours deposition

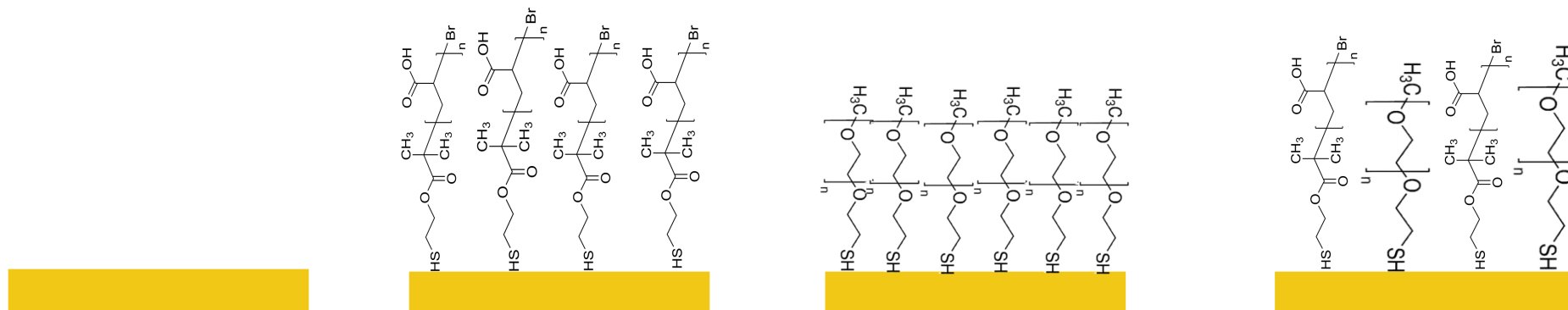

Gold

Pure PAA

Pure PEO

50/50 PAA/PEO



ÉCOLE CENTRALE LYON

Force curves in pure water

Simple force curve
Set point = 0,2 V

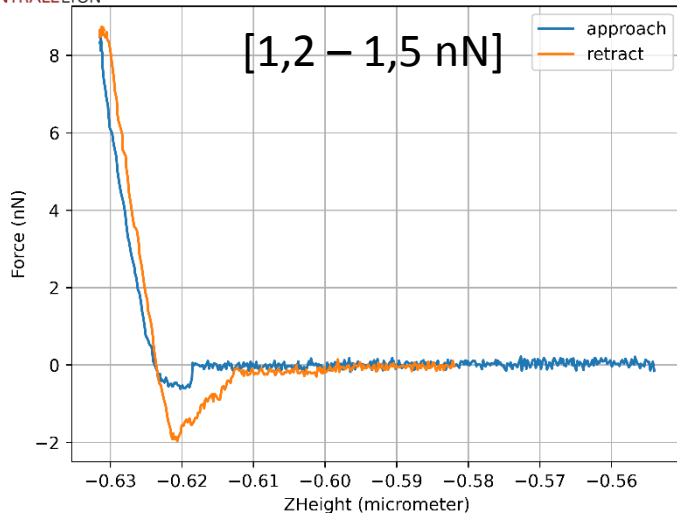

Gold

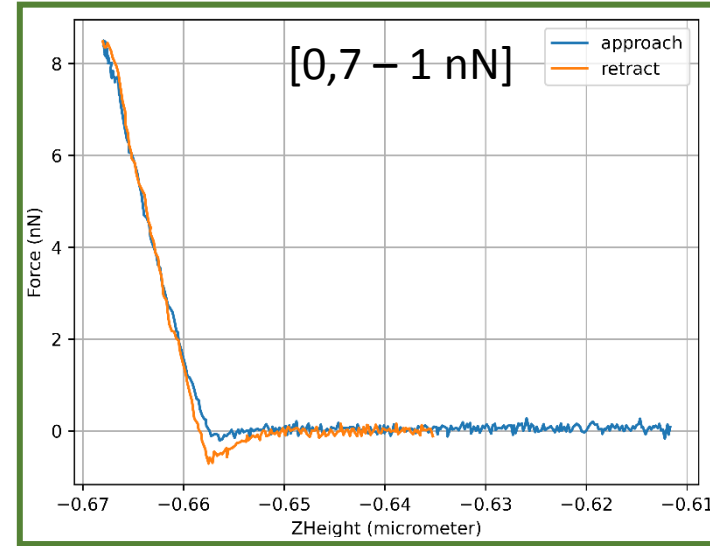

Pure PAA

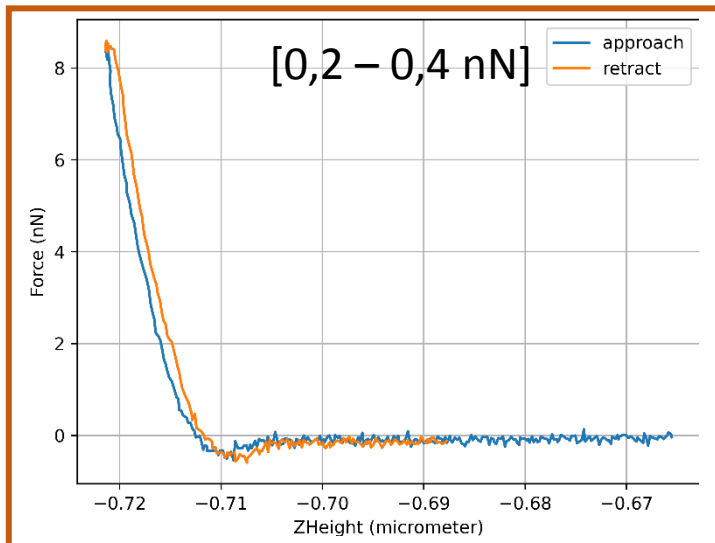
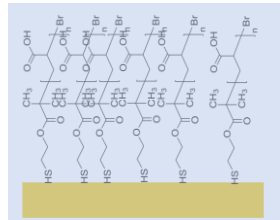

Pure PEO

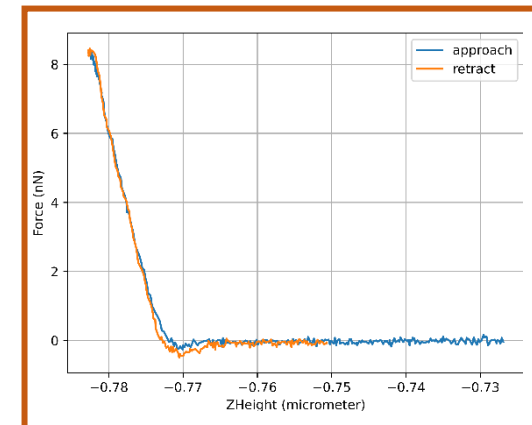
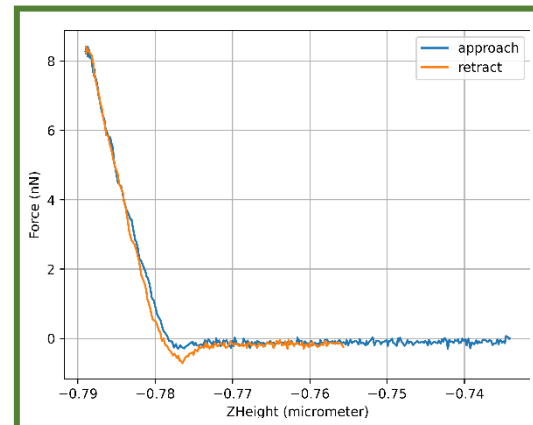
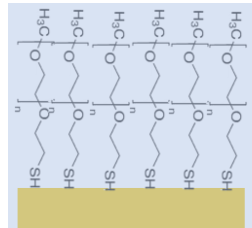

50/50 PEO/PAA

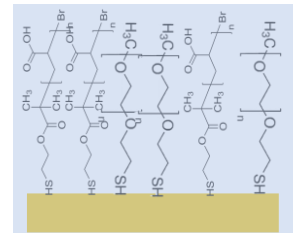

- Implement 3D-AFM in our AFM

3D-AFM measurements

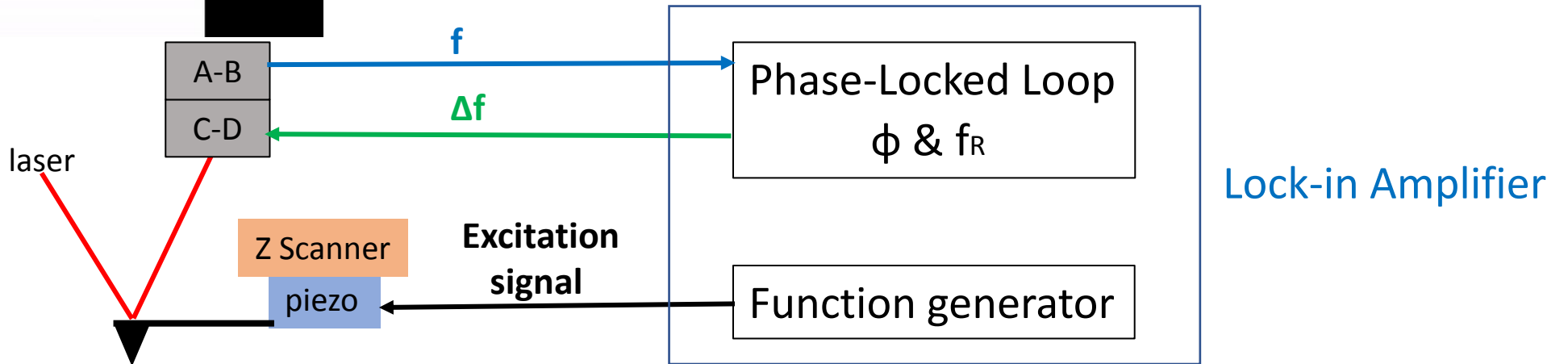
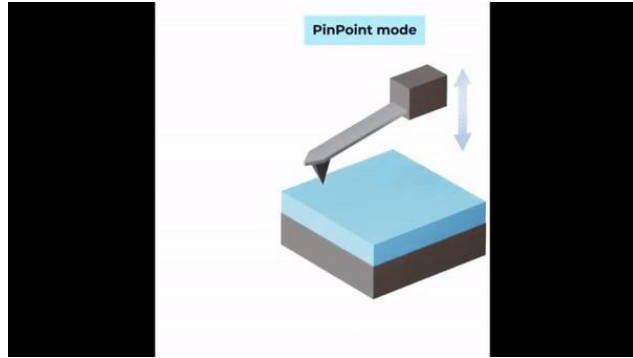

$\Delta f \rightarrow \Delta F \rightarrow 3D \text{ force maps}$

$$F(z) = 2k \int_z^\infty \left(1 + \frac{a^{1/2}}{8\sqrt{\pi(t-z)}} \right) \Omega(t) - \frac{a^{3/2}}{\sqrt{2(t-z)}} \frac{d\Omega(t)}{dt} dt$$

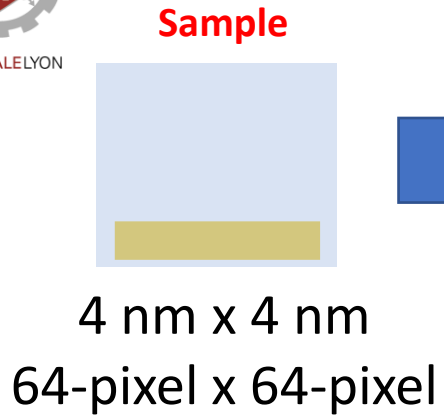

3D-AFM measurements

1 Δf curve/pixel
 \approx 500 points/curve

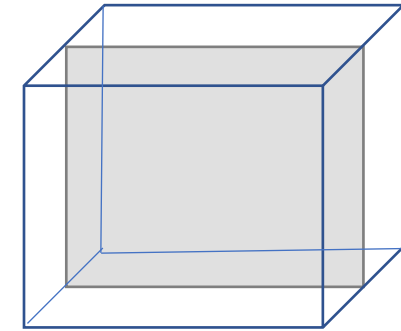

3D Δf map

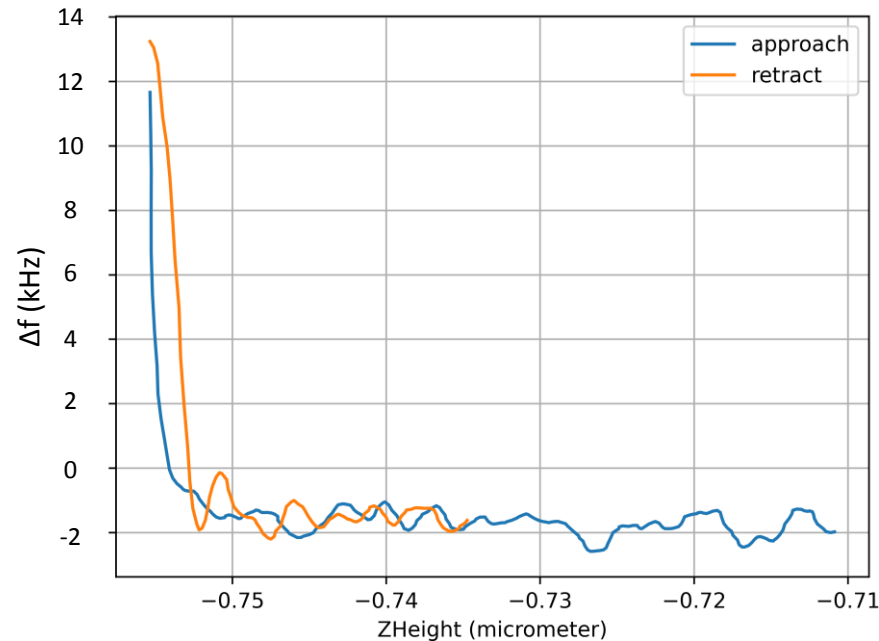
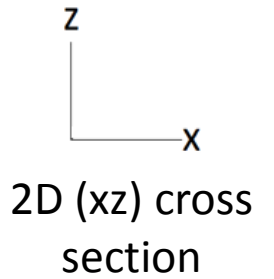

Gold



ÉCOLE CENTRALE LYON

3D-AFM measurements in 0,01M PBS

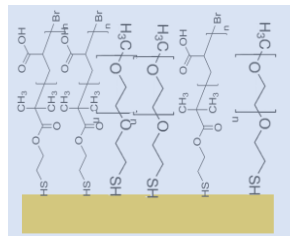
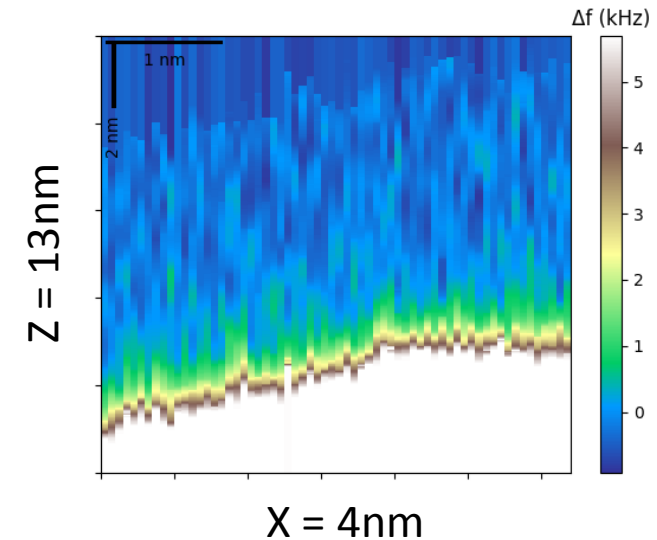
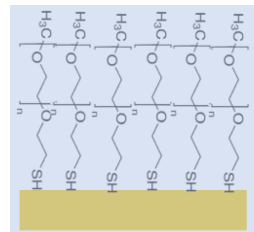
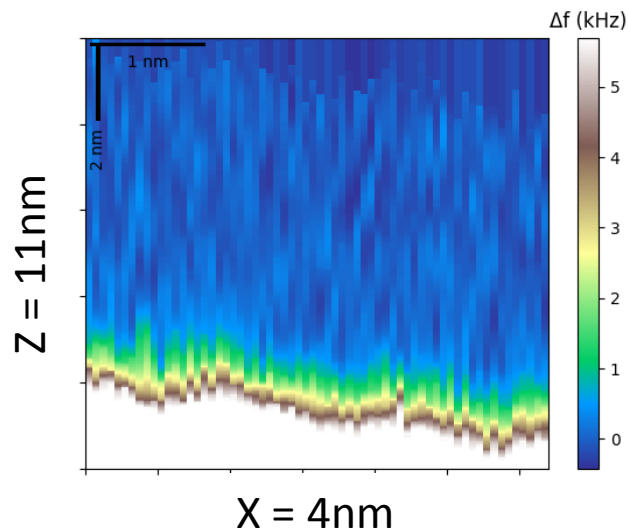
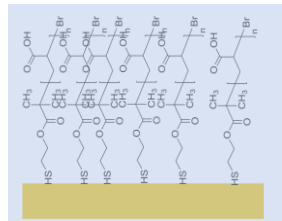
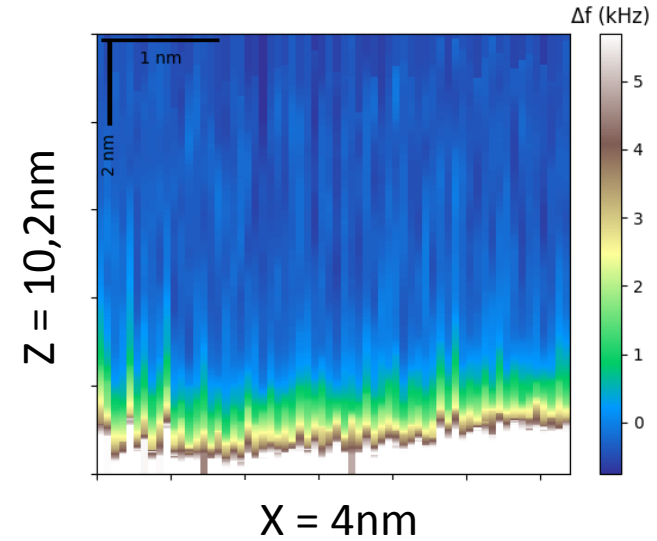
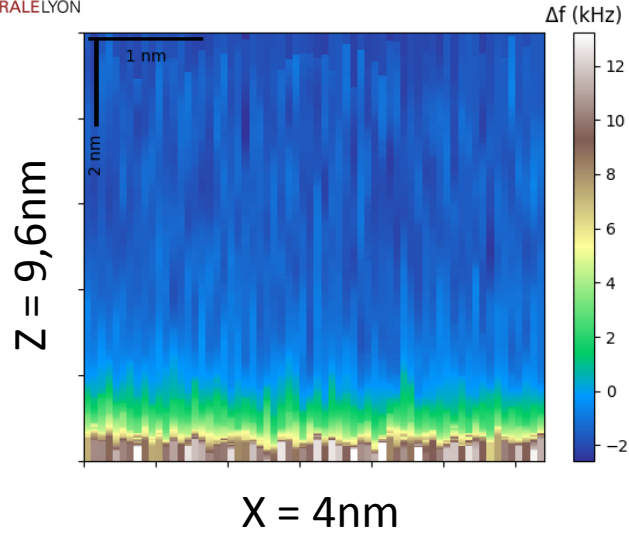

Conclusion

1. 3D-AFM for interfacial characterization
2. Imaging few nanometers above the surface
3. Visualization of hydration layers, adsorbed ions and mobile polymer extremities



Mica-KCl interface

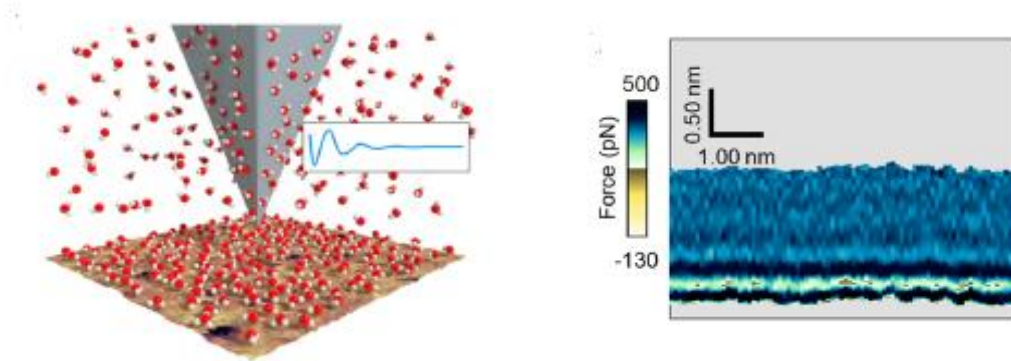

Mica-octane interface

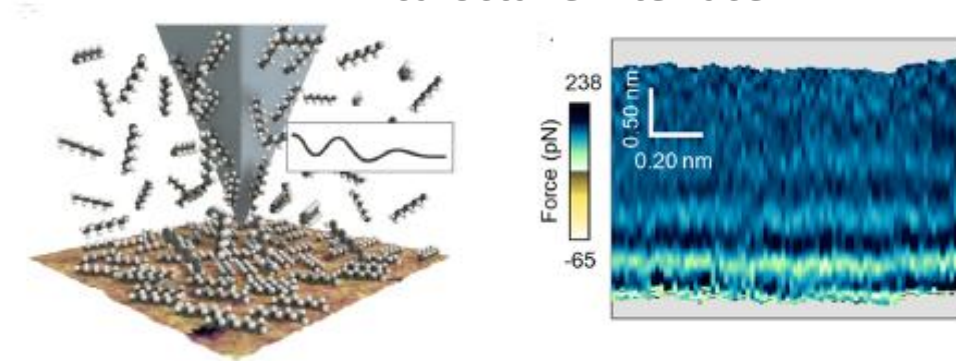

Thank you for
your
attention!!

Additional slides

Criteria for choosing the curves

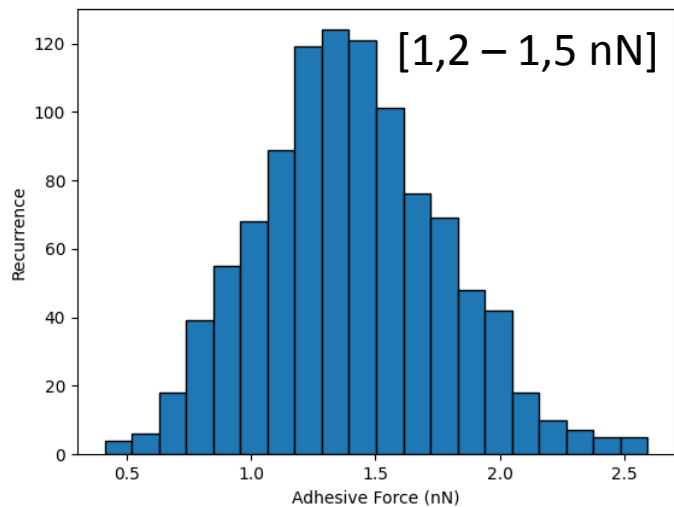

Gold

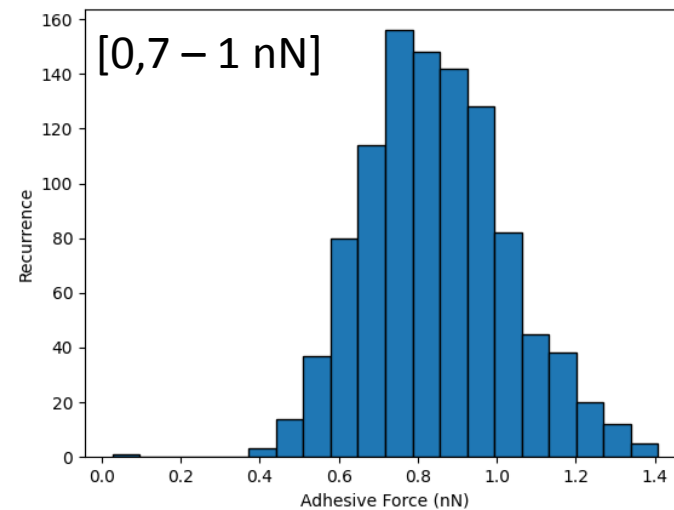

Pure PAA

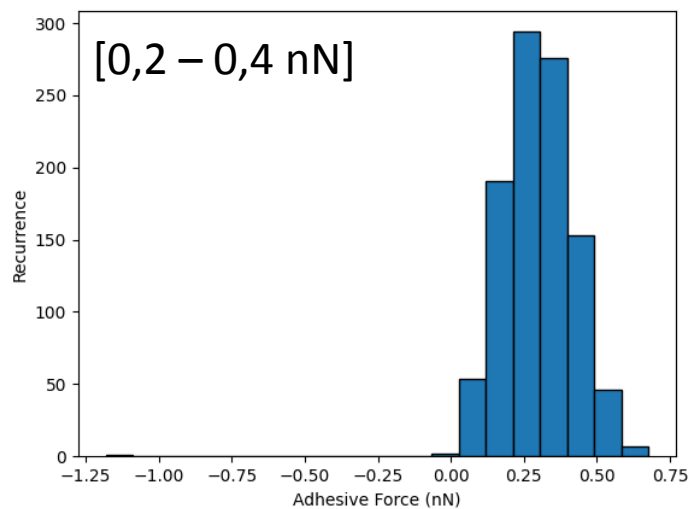
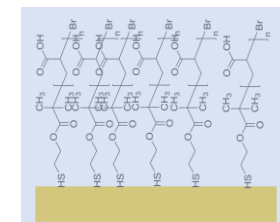

Pure PEO

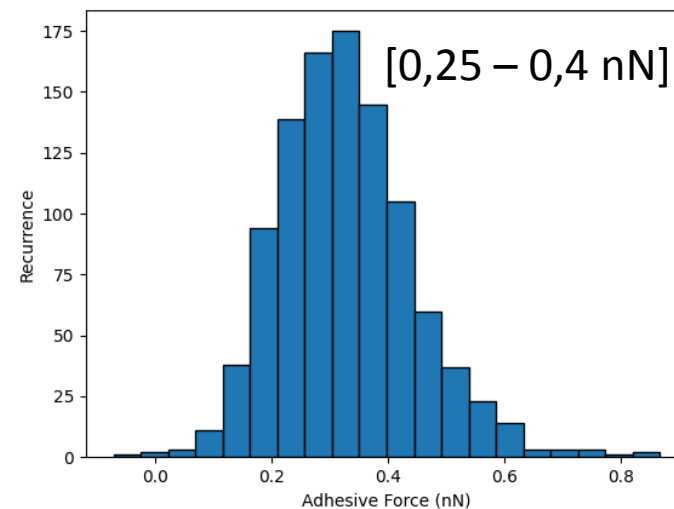
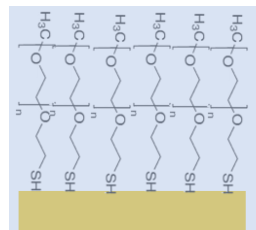

50/50 PEO/PAA

