



HAL
open science

Cuprous ions influence on the biocorrosion of a carbon steel in the presence of Sulphate Reducing Bacteria marine biofilm

Souad Belkaid, Dalila Mansour, Farida Laadjal Salah, Abdeltif Amrane

► To cite this version:

Souad Belkaid, Dalila Mansour, Farida Laadjal Salah, Abdeltif Amrane. Cuprous ions influence on the biocorrosion of a carbon steel in the presence of Sulphate Reducing Bacteria marine biofilm. *Regional Studies in Marine Science*, 2024, 69, pp.103307. 10.1016/j.rsma.2023.103307. hal-04327430

HAL Id: hal-04327430

<https://hal.science/hal-04327430v1>

Submitted on 2 Feb 2024

HAL is a multi-disciplinary open access archive for the deposit and dissemination of scientific research documents, whether they are published or not. The documents may come from teaching and research institutions in France or abroad, or from public or private research centers.

L'archive ouverte pluridisciplinaire **HAL**, est destinée au dépôt et à la diffusion de documents scientifiques de niveau recherche, publiés ou non, émanant des établissements d'enseignement et de recherche français ou étrangers, des laboratoires publics ou privés.

Cuprous ions influence on the biocorrosion of a carbon steel in the presence of Sulphate Reducing Bacteria marine biofilm

Souad Belkaid^a, Dalila Mansour^b, Farida Laadjal Salah^c, Abdeltif Amrane^d

^a*Department of Chemistry, Faculty of Sciences, M'Hamed Bougara University.*

Avenue de l'Indépendance, Boumerdes, Algeria. E-mail: s.belkaid@univ-boumerdes.dz

^b*Corrosion laboratory, Laboratories-Sonatrach Division.*

Avenue 1er novembre, Boumerdes, Algeria. E-mail: d.mansour@hotmail.fr

^c*Sonatrach General Directorate. Djenane El Malik Hydra, Algiers, Algéria*

E-mail: farida.laadjaladjal@sonatrach.dz

^d*Univ Rennes, École Nationale Supérieure de Chimie de Rennes, CNRS, ISCR (Institut des Sciences Chimiques de Rennes) – UMR 6226, F-35000 Rennes, France*

Corresponding authors: Souad Belkaid (belkaid_so@yahoo.fr); Abdeltif Amrane (abdeltif.amrane@univ-rennes1.fr)

Abstract:

The influence of marine sulphate reducing bacteria (SRB) biofilm on naval carbon steel corrosion in seawater was studied in the presence or not of cuprous ions as polluting agent. **The optical density measurement showed that a concentration of 15 mg L⁻¹ in cuprous ions can cause a significant slowdown in the proliferation of planktonic bacteria. However, electrochemical impedance results indicated that there was still bacterial activity on the metal substrate. Indeed, biofilm was grown on the surface of material in seawater containing SRB. Initially, an increase in the charge transfer resistance values due to the iron sulphide layer formed by the bacteria precipitation reactions was recorded during growth phase. This film acts as a barrier, preventing further oxidation of the underlying metal; then, the localized breakdown of iron sulphide layer generates an acceleration of corrosion.** Similar behaviour occurs in the presence of sulphate reducing bacteria flora with 15 mg L⁻¹ cuprous ions. In order to protect themselves **when the seawater media containing toxic metals**, sulphate reducing bacteria embed into clusters and **increase** the production of extracellular polymeric substances on materials. **Sulphur was present on specimens in both cases and EDS spectra revealed the formation of iron sulphide. After the removal of biofilm, carbon steel surfaces exhibited a plenty of micropits scattered on the entire surface compared to the surface immersed in the seawater without bacteria.**

Keywords: Carbon steel, Seawater, Biofilm, Sulphate Reducing Bacteria, Cuprous ions.

1. Introduction

Since a long time, corrosion was generally associated with the presence of oxygen. In 1934, Von Wolzogen Kuhr and van der Vlugt [1] have suggested that corrosion took place in oxygen-free environments and anaerobic bacteria were responsible for it. Since then, some researches were devoted to this field. In 1980s and 1990s, the impact of microorganisms in corrosion problems has attracted the interest of many industries, such as gas and oil sector, and consequently incited further studies with accuracy advances in microbiological identification process and electrochemical techniques.

It is established now that sulphate reducing bacteria (SRB) is one of the most relevant groups of bacteria in the corrosion processes of materials. These anaerobic bacteria use the sulphate as a final electron acceptor in metabolism. The sulphate reduction is indicated by the production of sulphide which is an oxidizing agent for different metals. Extensive works explaining the mechanism have been reported: precipitation of iron sulphide which catalyses proton reduction into molecular hydrogen and acts as a cathode in a galvanic couple with metallic iron [2], possible production of corrosive phosphides PH_3 that enhances the dissolution of metal under anaerobic conditions and leads to the formation of iron phosphide (Fe_2P or $\text{Fe}_3(\text{PO}_4)_2$) [3], differential cell related to pH difference [4], metal ion complexation by extra cellular polymer substances (EPS) [5] and local acidification derived from bacterial metabolites secretion of H_2S or NH_3 [6]. Furthermore, recent works [7, 8] suggested that certain enzymes facilitate the electron uptake in extracellular matrix which could also accelerate the corrosion.

Heavy metals are ubiquitous and are persistent environmental pollutants; they are introduced into the environment through anthropogenic and agricultural activities, such as mining and associated industries, fertilizers and pesticides applied in soil cultivation as well as through other sources of technological waste [9]. In seawater, certain heavy metals are necessary for enzymatic functions and bacterial growth [10], but they can form toxic compounds which are too dangerous for biological functions at higher concentration [11]. Copper is used by cells in small quantities in cellular enzymes (cytochrome c oxidase) [12]. However, level of copper accumulated in some environments such as coastal seawaters is found considerably higher than the standard concentration, due to its large use in industry, agriculture and marine paints [13].

To survive under heavy metal stressed conditions, bacteria have evolved several types of mechanisms to tolerate the uptake of heavy metal ions. Various adaptation mechanisms have been reported in many researches: metal sorption and mineralization, reduction of a metal to less toxic species by chelating agents, uptake and accumulation, biosynthesis of metal-binding proteins, extracellular precipitation, enzymatic oxidation or reduction to a less toxic form and efflux of heavy metals from the cell to genetic basis [14-16].

Lin and Olson [17] studied bacteria isolated from a water distribution system that underwent copper corrosion; they found that 62% of these bacteria are resistant to copper. Relatively, fewer studies have been devoted to the influence of this heavy metal on the sulphate-reducing bacteria and its role in accelerating the metals corrosion.

In this study, we sought to assess the effects of copper toxicity on sulphate reducing bacteria. The correlations among SRB, simulated seawater condition and corrosion behaviour of carbon steel were studied with and without cuprous ions (Cu^+). The bacterial cell concentration was estimated from the optical density of

the suspension at 580 nm during the growing process of SRB and the corrosion rate of “BV grade A” carbon steel was investigated by the electrochemical impedance spectroscopy (EIS). This study was completed by Scanning Electronic Spectroscopy (SEM) observations of the SRB biofilm and the steel surface.

2. Materials and methods

2.1. Test medium and carbon steel sample

The naval carbon steel BV-grade A was investigated in this study. This steel is widely used for offshore building; its nominal elemental composition was: Fe 98.66, Mn 0.83, Si 0.24, C 0.17, Cu 0.024 and S 0.0093. The sample was cut from the original plate with a thickness of 18 mm, mounted in a special holder and leaving a circular area of 0.785 cm². The surface of the working electrode was treated by mechanical polishing up to grade 1200 with a series of silicon carbide papers, rinsed with distilled water, degreased in acetone followed by sterilizing in 70 % ethanol and immediately transferred into the test medium. The electrolytic medium used was a simulated sea water prepared according to ASTM D1141-90 norm. It had the following composition per liter of distilled water: 24.54g NaCl; 11.1g MgCl₂.6H₂O; 4.09g Na₂SO₄; 1.16g CaCl₂; 0.69g KCl; 0.2g NaHCO₃; 0.1g KBr; 0.027g H₃BO₃; 2.1g SrCl₂.6H₂O and 0.003g NaF.

2.2. SRB cultivation and influence of copper concentration

The sulphate-reducing consortium used in this study was isolated from coastal seawater in estuarine Algerian region. The consortium was isolated in API RP 38 medium containing per liter of distilled water: 4.0ml C₃H₅NaO₃ (sodium lactate 60 to 70 %); 1.0 g yeast extract; 0.1g C₆H₈O₆ (ascorbic acid); 0.2g MgSO₄.7 H₂O; 0.01g K₂HPO₄; 0.2g Fe (SO₄)₂NH₄.6H₂O; 25g NaCl. The pH medium was adjusted to 7.4. The medium was distributed in 9ml amounts into a series of 15ml capacity test tubes, each one containing iron degreased nail. Test tubes were degassed with nitrogen gas and sterilized by autoclaving for 20min at 121°C and at a pressure of 1bar. SRB consortium was obtained by introducing 1ml of coastal seawater into each medium tube and incubating at 30°C until dark deposit obtained.

For optimizing the maximal toxic cuprous ion concentration on the SRB growth, seven batch marine SRB cultures were conducted in 250 ml Erlenmeyer flasks, which contained artificial seawater enriched by API RP 38 components except NaCl. Cuprous ions (from cuprous chloride) concentrations tested were: 0 mg L⁻¹, 5 mg L⁻¹, 10 mg L⁻¹, 15 mg L⁻¹, 20 mg L⁻¹, 25 mg L⁻¹ and 30 mg L⁻¹. These concentrations correspond to the extreme pollution conditions of the natural exposure of bacteria in metal polluted environments [18]. The natural concentrations variation depends principally on the meteorological conditions and the presence of mining waste and industrial effluents. Prior to the inoculation, medium was degassed with nitrogen gas and autoclaved. All containers were inoculated by 2% aliquot of 48 hours old SRB consortiums and incubated at 30°C for 14 days. The SRB densities in different batch cultures, were monitored by measuring the optical density (OD) at a wavelength of 580nm (OD₅₈₀) with a UV- visible spectrophotometer (JASCO V-530 UV/VIS Spectrophotometer). Iron sulphide was beforehand removed by centrifugation at 1,000 g for 5 min.

2.3. Electrochemical measurements

Tests were performed using EIS technique to study the evolution of different electrochemical interfaces with the immersion time, considering three surface conditions (a) steel in sterile medium (b) steel in the presence of SRB and (c) steel in the presence of SRB with cuprous ions. Aliquot (about 2%) of 48 hours old SRB consortia were used in SRB tests conducted anaerobically at 30°C during 14 days. For this study, an electrochemical reactor with three electrodes was used providing anaerobic conditions: a saturated calomel electrode as a reference and a graphite rod as a counter electrode. Impedance measurements were carried out by SOLATRON SI 1255 frequency response analyser, at corrosion potential using a sinusoidal signal with amplitude of ± 10 mV, within a frequency range from 100 KHz to 0.001Hz, generated by EG&G 273A potentiostat.

2.4. Steel surface and SRB biofilm observation

In order to observe the state of the steel working electrode surface before and after SRB attack, OLYMPUS metallographic microscope was used. The marine biofilm of SRB formed on the BV grade A steel surface was visualized using a Jeol JSM-63 60 LV scanning electronic microscope.

3. Results and discussion

3.1. SRB growth and copper effect on metabolism

A blackening due to the dark deposit of metallic sulphide was obtained after incubation of the API RP 38 coastal seawater isolates. The SRB marine consortium produces iron sulphide which is the result of the metabolic reactions between iron and sulphate ions [19, 20]: The metabolism of these bacteria is characterized by the reduction of a terminal electron acceptor (sulphate) coupled with the oxidation of an electron donor, which is the most often an organic substance (lactate or acetate) or hydrogen:



In fact, due to the low redox potential of the sulphate ion, its reduction requires activation by ATP sulphurylase. It leads to adenosine phosphosulphate (APS) and pyrophosphate (PPi). APS is reduced to adenosine monophosphate (AMP) and sulphite, which is further reduced to hydrogen sulphide [21]. The hydrogen sulphides formed can be either in the form of H_2S , HS^- or S^{2-} depending on the pH of the medium.

In our study, lactate is used as an electron donor and carbon source by sulphate reducers. Sulphate reduction occurs concurrently with lactate oxidation. Lactate is oxidized either incompletely and converted into organic acids, usually acetic acid as confirmed by several studies [22, 23]:

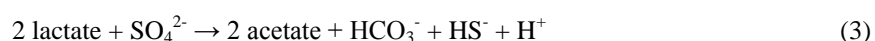

or completely to form carbon dioxide:

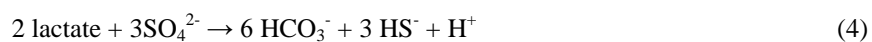

The temporal variation of pH in the batch reactor without cuprous ions is presented in Fig.1. The pH decreased from 7.45 to 6.72 during the exponential phase of growth when the number of SRB reached its maximum (2 days) and thereafter it increased throughout the death phase. In fact, sulphate-reducing bacteria (SRB) growth modify the acid-base properties of the medium. The excretion of metabolic products such as acetic acid, CO₂ and H₂S tends to acidify it, especially in the first two days of incubation corresponding to the exponential phase, as mentioned by Kuang et al. [24]. While on the contrary, sulphide and bicarbonate are produced as sulphate is reduced in the presence of a suitable carbon source (eq.3 and 4). The bicarbonate alkalinity neutralizes acidity while dissolved metals are precipitated by the sulphide and the production of acidic product is stabilized in the later phase.

However, pH measurements tend to be reported for the bulk environment, which may not reflect the conditions under the biofilm. The biological metabolism occurs at different locations under the biofilm formed on metallic substrate and leads to differential environmental properties [25].

The growth of SRB in enriched seawater culture in the presence of increasing concentrations of cuprous ions was analyzed and presented in Fig.2. Four distinctive metabolic compartments of SRB towards the presence of Cu⁺ ions can be illustrated:

- Control: in the absence of cuprous ions, no lag phase occurring and the OD₅₈₀ value increased exponentially to about 1.08 after 1 day of incubation. After, OD₅₈₀ decreased with the incubation time, indicating a reduction in the number of bacteria in the reactor, due probably to the lack of an external carbon source, as it was essentially consumed in the first two days. Furthermore, it has reported that the growth of sulphurogenic bacteria may be limited by the inhibitory effect exerted by metabolic products and in particular by H₂S [26]. This compound would act as an energy decoupling when crossing the cell membrane by passive diffusion [27]. According to Utgikar et al. [28], the produced sulphides react and precipitate the Fe²⁺ ions from the culture medium. As a result, bacterial growth may in some cases be severely limited by the availability of Fe²⁺ ions. Furthermore, the formed metal sulphides act as barriers preventing the access of the reactants (sulphate, organic matter) to the necessary enzymes.
- Cu⁺ concentrations of 5 and 10 mg L⁻¹: as the added concentration of Cu⁺ increased, the growth of SRB cultures decreased and a significant lag phase was observed whose duration increased with the concentration. There was even light OD₅₈₀ reduction value, due to the reduction of cells activity. SRB metabolic processes take time to adapt their molecules and enzymes to the new formulation medium. It is clear that Cu⁺ ions are inhibitors for SRB growth, but the tested concentrations are not so fatal on cells, as shown from the growth observed after lag phase.
- Cu⁺ concentration of 15 mg L⁻¹: inhibitor effect of Cu⁺ ions on SRB growth was very significant, as shown from the OD₅₈₀ decrease, from its initial value (about 0.2) to 0.1 after nine days. This period represents in fact, the time taken by cells to defend against cuprous ions toxicity and to establish the biochemical mechanisms for their resistance. After that, the growth resumption was similar to that observed at lower concentrations.

■ Cu^+ concentration of 20, 25 and 30 mg L^{-1} : these copper concentrations are very toxic, as indicated by the OD_{580} decrease from its initial value to zero. Consequently, 20 mg L^{-1} of copper ions can be considered as the minimum lethal concentration on the metabolism of SRB cells in the considered conditions; and 15 mg L^{-1} seems to be a critical threshold concentration above which growth is completely inhibited.

Thus, high concentrations of dissolved cuprous ions have a negative effect on bacterial growth, and cause a reduction of sulphate removal rates in SRB. Similar behaviour has been reported by other researchers studying different bacterial strains in the presence of copper ions as toxic heavy metal: Jin et al. [29] exhibited that 0.8 mg L^{-1} copper did not have inhibitory effects on sulphate-reducing bacteria growth. At 8 mg L^{-1} copper, activity in SRB consortia was significantly inhibited. When the dissolved copper concentration was 30 mg L^{-1} , sulphidogenic activity was completely inhibited. In other conditions [30], SRB growth and sulphate reduction could be possible between 100 and 1500 mg L^{-1} of initial copper concentration.

Certainly, the potential copper toxicity depends on the type of bacteria or the exposed microbial community and also on the nutrients in medium, temperature, pH, concentration of chelating agents, concentration of inorganic anions and competition from other cations [31-33]. The critical threshold concentration can range from few $\text{mg}\cdot\text{L}^{-1}$ to over a thousand $\text{mg}\cdot\text{L}^{-1}$ [30].

In studied conditions, the results show that SRB tolerate concentrations up to 15 mg L^{-1} in the aqueous phase. The mechanisms for tolerance of high concentrations may be associated with processes of surface adsorption and biofilm formation, among others. Recent studies had focused on heavy metal tolerance [34, 35]. These results suggest a stronger tolerance of copper ions on surface adhesion and biofilm formation compared to planktonic cells. The cell adhesion would increase in the presence of sub-lethal heavy metal concentrations. Bacteria survival in mature biofilms revealed an important role of biofilms in metal immobilization and sequestration processes in metal-polluted environments [34].

3.2. Electrochemical impedance measurements

The impedance spectra of a BV grade A carbon steel sample exposed to the sterile nutrient-rich seawater for 0, 24, 48, 96, 192 and 250 hours are shown in Fig. 3. The Nyquist plots reveal that the diameter of the impedance spectra increased considerably with time. This behavior represents the change in the charge transfer resistance (R_{ct}) that describes the evolution of the anodic reaction controlled by the charge transfer process [36]. The corrosion rate became lower with the exposure time which can be attributed to the formation of a protective layer increasingly more compact and/or thick. The Bode phase angle plots (Fig. 3-b) are slightly flattened, which suggests that there are two small juxtaposed maxima without separation by a lower phase angle domain. The formation of these maxima is better identified for the initial stage of incubation indicating the presence of two time-constants. According to Edgar et al. [37], the presence of two collapsed time constants may be due to the fact that different stages of the corrosion process may have similar relaxation times. For this reason, the presence of two simultaneous phenomena can be suggested to explain the carbon steel impedance response in sterile nutrient-rich medium.

The presence of two semi-circle in the Nyquist diagrams, or two peaks maxima in the bode phase angle plots, can be attributed to the formation of a conditioning layer on the metal surface as well as the corrosion

products layer [36]. The outer conditioning layer results from the instantaneous precipitation of various species like chlorides, phosphates and organic compounds, which exist in seawater and culture medium composition. The adsorption of these macromolecules is the first stage of biofilm formation and it consists of instantaneous attraction implying modification of the surface state as surface tension, free energy of surface, polarity....

To describe the impedance response of this corrosion phenomenon, results were fitted to a circuit presented in Figure 4 using the nonlinear least-square method in Zview software. It should be pointed out that the impedance spectra described above show semi-circles with the centre below the x-axis, commonly related to the heterogeneous nature of the solid surface or by the dispersion of some physical properties values of the system [38]. Consequently, a constant phase element (Q) justifying this phenomenon is considered as a substitute for an ideal capacitor.

Here R_e is the solution resistance, R_{ct} is the resistance associated with the charge transfer process. Q_{ct} is the non-ideal double layer capacitance used in order to consider the roughness of the interface. The terms Q_o and R_o are the parameters related to the outer layer of organic/ inorganic compounds formed at the interface.

Table 1 shows the obtained electrical parameters values. The presence of an inhomogeneous surface is confirmed by CPE exponent parameter values ($n < 1$) related to a non-ideal behaviour of a capacitor. Both resistances values R_{in} and R_o increased as a function of the immersion time. This indicates the protectiveness of oxides layer jointly with conditioning layer whose thickness and/or dielectric nature is being modified.

Capacitance values associated to the inner and outer layers are calculated by the following relationship according to Brug et al. [39]:

$$C_{eq} = (QR_{ct})^{1/n} / R_{ct} \quad (3)$$

Conditioning layer capacitance C_o values fluctuated in a narrow range from 81 to 150 $\mu\text{F}/\text{cm}^2$. This result indicates that conditioning layer porosity remained unchanged. On the contrary, charge transfer capacitance C_{ct} decreased continuously from 523 to 268 $\mu\text{F}/\text{cm}^2$, indicating a progressively lower permittivity and an increase of corrosion products layer thickness, which confirms a slower attack of the steel with the exposure time [40].

Figure 5 shows impedance plots obtained for BV grade A surface in the presence of SRB culture at 0, 48, 96, 216, 240 and 326 hours. Generally, it can be observed that impedance diameters were smaller than those obtained in the absence of sulphate reducing bacteria. An acceleration of the corrosion process in the presence of SRB was manifested on the metallic surface. Indeed, semicircles obtained at immersion times of 0 and 48 h show an irregular response characterized by an extension of the plot beyond a shape of a semicircle. This behaviour can be associated with the presence of two time-constants, corresponding to the oxides layer and conditioning layer formation as was said before.

The exceptional behaviour is that obtained at 96h of immersion where a straight line is established for all the frequency range. The existence of such behaviour had previously been considered by some investigators [41]. According to Skale et al. [42], this behaviour can be correlated with the formation of a passive film with high performance and excellent barrier properties. Such blocking surface is generally obtained by coated substrates [43].

In this context, several authors demonstrated that iron sulphides due to the steel/surface modification as a consequence of SRB biofilm formation and bacteria activities, can reduce rather than accelerate the corrosion of iron by impeding the diffusion of oxidized iron (Fe^{2+}) from the metal surface to the bulk liquid. They may, at least temporarily, lead to the protection of iron against corrosion [2, 28, 44]. This is explained by the formation of tightly adherent FeS passive layer on the metal surface. Mackinawite (FeS), greigite (Fe_3S_4) [45], Pyrite (FeS_2) and pyrrhotite ($\text{Fe}_{(1-x)}\text{S}$) [46] may be the main forms of iron sulphides.

At this stage, charge transfer resistance R_{ct} is extremely high. For this reason, electric element corresponding to this parameter can be eliminated from the electric circuit of Fig. 4, leading to the electric circuit presented in Fig. 6-a.

In Figure 5-a, the formation of semicircle in Nyquist plot for 216, 240 and 326 h of immersion can be associated with the presence of a single time constant, corresponding to charge transfer reaction with formation of corrosion products (iron oxides mixed with iron sulphides). However, in biotic environments, the sulphide films are unsteady. They are interrupted by bacterial metabolic activity, such as acetic acid production. The presence of acetic acid has recently been suggested to inhibit the protectiveness of iron sulphide corrosion products [47]. Therefore, with the proliferation of the SRB and metabolic products, this film decomposed and degraded to other polysulphide products [36, 47]. Subsequently, this broken iron sulphides layer, give corrosive conditions of hydrogen sulphide generated by SRB in biofilm. It acts also as a cathode in a galvanic couple with metallic iron which often leads to localized corrosion. In this stage, the conditioning layer formed by the organic compounds in addition to other species, can be consumed or destroyed by the bacterial biofilm. Equivalent circuit shown in Fig. 6-b describe impedance diagrams obtained in these cases. R_{ct} , Q_{ct} are the parameters related to charge transfer reactions under the unique layer formed by a mixture of oxides iron, sulphides irons and biofilm. This analysis tends to propose an oxidation mechanism of the interface in the presence of SRB biofilm.

Table 2 shows the electric parameters of the equivalent circuit presented in figures 4 and 6. These parameters are obtained from the best fitting of the experimental impedance diagrams of the carbon steel immersed in nutrient-rich simulated seawater, in the presence of SRB.

Conditioning layer resistance R_o in the presence of sulphate reducing bacteria remained relatively constant but its capacitance C_o increased from $121 \mu\text{F cm}^{-2}$ initially to $11724 \mu\text{F cm}^{-2}$ after 96 h of immersion. This result indicates that this layer became more porous before its disappearance at 216 h.

Charge transfer resistance R_{ct} increased from 8 to $31 \text{ K}\Omega \text{ cm}^2$ for the first 48 h and reached extremely high values at 96 h, before decreasing significantly to $1 \text{ K}\Omega \text{ cm}^2$ at 326 h of immersion which can be attributed to the corrosion process activation due to the presence of SRB biofilm. Therefore, biofilm formation leads to surface modification since the capacitance values C_{ct} increased to about 80 mF.cm^{-2} , indicating the formation of iron oxides and sulphides whose morphologies are porous as it was previously mentioned.

Figure 7 shows the respective Nyquist and Bode spectra of BV grade A in the SRB inoculated nutrient-rich simulated seawater in the presence of Cu^+ ions at 15 mg L^{-1} . As can be seen in the Nyquist plots, the behaviour obtained for this interface is similar to that obtained without Cu^+ ions. Therefore, the SRB affect the behaviour even in the presence of Cu^+ ions at this concentration. It is worth noting that a straight line attributed to the formation of passive irons sulphides layer was also obtained at 96 and 168 h. Thereafter, a change in

complex plots with a semicircle was observed, when the sample was immersed for 192 and 240 h, corresponding to a single time constant with charge transfer mechanism. Furthermore, the SRB biofilm presence acts on carbon steel behaviour with Cu^+ ions, although the optic density evolution of planktonic bacteria shows a stunted growth until 9 days of immersion.

The results indicate that the corrosion behaviour of the steel does not depend on the number of the active SRB, but on the accumulation of the metabolism products of SRB. Microbes in marine biofilms aggregate into clusters and increase the production of extracellular polymeric substances (EPS), by over 100% in some cases, when the seawater media containing toxic metals and chemicals [34]. While heavy metals can inhibit planktonic SRB growth, some enzymes could be involved in the oxidation of periplasmic Cu(I) to less toxic Cu(II) [48] and sulphides products which are produced biologically during sulphate reduction by SRB, and could precipitate Cu(II) ions as CuS [49]. This decreases or even eliminates the toxicity of the cuprous heavy metals toward SRB.

The impedance spectra obtained after different exposure periods are analysed and fitted according to circuits previously proposed: Fig. 4 is considered to fit results corresponding to 0h, when a layer of organic and inorganic compounds as well as the activation control process attributed to the formation of a second layer of corrosion products is suggested. Fig. 6-a gives the best fitting of diagrams obtained at 96 and 168 h, and Fig.6-b is considered to discuss steel oxidation mechanism in the presence of the biofilm. The main results of the fitting procedure are presented in table 3.

Conditioning layer resistance R_o values increased from 0.596 to 2.44 $\text{K}\Omega \text{ cm}^2$ and capacitance C_o values from 0.324 to 19.14 mF cm^{-2} corresponding to a porous film. The porosity of this layer may be favoured by biofilm adhesion. Thereafter, it is considered that there is also formation of an iron sulphides film as a consequence of biofilm metabolism. Therefore, R_{ct} reached high values at 96 and 198 h and once again decreased to achieve a value close to that obtained in the absence of Cu^+ after 240 h of immersion.

3.3. Linear polarisation

Linear polarisation measurements can be used to calculate corrosion parameters such as the polarisation resistance (R_p) which, according to Stern and Geary's relationship, is inversely proportional to the corrosion current. Figure 8 shows the evolution of the polarisation resistance of the carbon steel in sterile and SRB inoculated mediums in the presence of 15 and 20 mg/L cuprous ions. There is a good concordance between these results and those obtained by the EIS method. In sterile seawater, R_p increases generally with time indicating that a stable layer of oxides protects the metal from corrosion. Probably, its thickness increases with the increasing of the immersion time. In SRB inoculated seawater in the presence or not of 15 mg.L^{-1} cuprous ions, R_p shows the same behaviour in both cases with a shift of several hours related to lag phase observed in the presence of toxic metallic ions. Bacteria increase the polarisation resistance during the first time related to proliferation stage and consequently iron sulphur formation. Then, R_p decreases continually and causes a severe damage such as pitting corrosion accompanied by breakdown and a degradation of the protective properties of the film. In the presence of 20 mg/L Cu^+ , no effect of SRB was recorded and the steel shows similar behaviour to that obtained in sterile environment.

3.4. Biofilm and pitting corrosion observations

Scanning electron images of the substrate immersed in simulated seawater with SRB biofilm show the wealth of the isolated consortium (Figure 9-a). Different cellular forms covering the masses of extra polymeric substances (EPS) synthesized by SRB are observed. An enlargement of the mass of the SRB cells (Figure 9-b) show a large diversity: straight and incurved rods, cocci, vibrio and bacillus; these cellular agglomerates are surrounded by EPS layer. The synthesis of EPS by SRB leads to multistage structure; its porosity and heterogeneity are well revealed. This extra cellular matrix conducts to the maturation and the structuring of the biofilm which is the principal resistant form for bacterial communities against aggressive environments [34]. Several organic compounds can exist in EPS matrix e.g. cellulose, alginates, proteins, lipids, nucleic acids, polysaccharides and extracellular DNA [50]. Further, the iron sulphides accumulated on the metal surface can be observed on the steel surface (Fig. 9-c).

Biofilm in the presence of 15 Cu^+ is shown in Figure 10-a. Bacteria in exopolymeric substances (EPS) can be observed with the remarkable disappearance of certain forms, notably the vibrio form in the presence of 15 mg/L Cu^+ . The coccoid form seems to be the most resistant and the most adaptable form to the presence of metal ions. In this context, Cabrera's results [51] showed that *D. vulgaris* is more sensitive to copper concentration than *Desulfovibrio sp.* The difference in behaviours is due to natural tolerance to toxic substances. However, 20 mg/L causes almost complete inhibition of the bacteria (fig.10-b).

The SEM technique is often coupled with energy dispersive spectroscopy (EDS) and has been used to evaluate the chemical composition of products on the steel surface. The EDS analysis of surface biofilm without copper ions (Fig. 9-b), shows that the main elements are Fe and O. Other minor elements are present, namely S, Na, Cl, and Ca. They probably arise from bacterial metabolism and seawater. It can be seen that oxygen is present in the surface layer with a large amount justified by a precipitation of solid ferric hydroxide $\text{Fe}(\text{OH})_3$ as corrosion product [52] jointly with iron sulphides compounds. In 15 mg/L cuprous ions, EDS spectra analysis (Fig. 10) carried out on extracellular polymeric substances shows that the oxygen and iron peaks remain considerably higher relatively to the sample immersed in SRB seawater. These peaks suggest probably that EPS develop conjointly with corrosion product to form a mixture as it was explained in physical model in Fig.6-b. It is important to point out that in this case, there is always a peak corresponding to the S element which indicates the presence of bacterial metabolic activity. In fig. 10, the elements Fe and O also showed a higher percentage in the presence of 20 mg/L cuprous ions with a notable absence of sulphur element.

After the removal of the biofilm, steel surface appeared rough as illustrated by Figure 11. Numerous micro-pits dispersed irregularly on the whole surface are observed on the steel immersed in non-sterile medium in the presence or not of 15 mg/L Cu^+ , confirming the results obtained by electrochemical techniques. On this subject, many authors [36, 41] explain the alteration of the metal in the presence of biofilm and show that a localized corrosion manifested by deeper pitting in comparison with abiotic controls is always sustained by bacterial colonies and accompanied by a deposit of FeS .

4. Conclusion

Corrosion of SRB marine biofilm on the carbon steel in simulated seawater was examined in the presence and absence of cuprous ions. At first, an optimization of toxic cuprous ions concentration on SRB

growth was carried out. Sulphate reducing bacteria (mixed SRB) can tolerate copper concentrations up to 15 mg L⁻¹, with adaptation phases varying from 2 to 9 days. From 20 mg L⁻¹, no growth was recorded throughout the trial period (14 days). So, the lethal concentration for these bacteria is between 15 and 20 mg L⁻¹.

The behaviour of SRB biofilm towards BV grade A steel was studied by electrochemical impedance spectroscopy, in three media. The first one was sterile nutrient-rich simulated seawater; the second and the third media were SRB inoculated nutrient-rich seawater in the absence and presence of copper ions at 15 mg L⁻¹, respectively. The steel immersed in the simulated and sterilized seawater became very passive with respect to corrosion due to the oxide layer formed on the surface. Resistance and capacitance values show that this layer became more protective by increasing its thickness and modifying its dielectric properties. The impedance diagrams and **linear polarisation plots** of the steel immersed in the inoculated seawaters show that the presence of 15 mg L⁻¹ of Cu⁺ did not have a significant influence on steel resistance. Carbon steel exhibited similar behaviour in both cases, namely in the presence and absence of Cu⁺. The biofilm acted unfavourably against corrosion, although the absorbance measurements showed a latency phase of 9 days at this copper concentration. **The cell adhesion would increase in the presence of sub-lethal heavy metal concentrations** to develop a means of protection against ion toxicity. Consequently, in heavy metals polluted coasts Sulphate Reducing Bacteria still remain a significant danger for biocorrosion.

References

- [1] Von Wolzogen Kuhr CAH, Van Der Vlugt IS. The graphitization of cast irons as an electrochemical process in anaerobic soils. *Water*, 18 (1934) pp. 134–147
- [2] Enning D, Garrelfs J Corrosion of iron by sulfate-reducing bacteria: New views of an old problem. *Appl Environ Microbiol*, 80 (2014) pp. 1226–1236. doi: 10.1128/AEM.02848-13
- [3] Iverson WP. Possible source of phosphorous compound produced by sulfate-reducing bacteria that cause anaerobic corrosion of iron. *Mater. Perform.* (1998) 37:46-49
- [4] Gu T, Galicia B. Can acid producing bacteria be responsible for very fast MIC pitting? In Proceedings of the Corrosion, Salt Lake City, UT, USA, 11–15 March, (2012) Paper No 1214
- [5] Hao L, Li J, Kappler A, Obsta M. Mapping of Heavy Metal Ion Sorption to Cell-Extracellular Polymeric Substance-Mineral Aggregates by Using Metal-Selective Fluorescent Probes and Confocal Laser Scanning. *Appl Environ Microbiol*, 79 (2013) pp. 6524–6534. doi: 10.1128/AEM.02454-13
- [6] Ogawa A, Takakura K, Hirai N, Kanematsu H, Kuroda D, Kougo T, Sano K, Terada S. Biofilm formation plays a crucial rule in the initial step of carbon steel corrosion in air and water Environments. *Materials*, 13 (2020) pp. 923–945. <https://doi.org/10.3390/ma13040923>
- [7] Tremblay PL, Angenent LT, Zhang T. Extracellular Electron Uptake: Among Autotrophs and Mediated by Surfaces. *Trends Biotechnol*, 35 (2017) pp. 360–371. <http://dx.doi.org/10.1016/j.tibtech.2016.10.004>
- [8] Deutzmann JS, Sahin M, Spormann AM. Extracellular enzymes facilitate electron uptake in biocorrosion and bioelectrosynthesis. *mBio*, 6(2) (2015) e00496–15. <https://doi.org/10.1128/mBio.00496-15>
- [9] Hasan MR, Khan MZH, Khan M, Aktar S, Rahman M, Hossain F, Hasan ASMM. Heavy metals distribution and contamination in surface water of the Bay of Bengal coast. *Cogent Environ Sci*, 2 (2016) pp. 1–12. <https://doi.org/10.1080/23311843.2016.1140001>
- [10] Ali H, Khan E, Ilahi I. Environmental Chemistry and Ecotoxicology of Hazardous Heavy Metals: Environmental Persistence, Toxicity, and Bioaccumulation. *J Chem*, (2019) pp. 1–14. <https://doi.org/10.1155/2019/6730305>
- [11] Storelli MM, Storelli A, D’daabbo R, Morano C, Bruno R, Marcotrigiano GO. Trace elements in loggerhead turtles (*Caretta caretta*) from the Eastern Mediterranean; Overview and evaluation. *Environ Pollut* 135 (2005) pp. 163–170. <https://doi.org/10.1016/j.envpol.2004.09.005>
- [12] Messerschmidt A. Copper Metalloenzymes. *Compreh Nat Prod II*, 8 (2010) pp. 489–545. doi:10.1016/B978-008045382-8.00180-5
- [13] Suresh Kumara C, Jaikumarb M, Robin RS, Karthikeyanc P, Saravana Kumard C. Heavy metal concentration of sea water and marine organisms in Ennore Creek, southeast coast of India. *J Toxicol Health*, 103 (2013) pp. 192–201
- [14] Chen Y, Jiang Y, Huang H, Mou L, Ru J, Zhao J, and al. Long-term and high-concentration heavy-metal contamination strongly influences the microbiome and functional genes in Yellow River sediments. *Sci Total Environ*, 637-638 (2018) pp. 1400–1412. doi: 10.1016/j.scitotenv.2018.05.109
- [15] Roosa S, Wattiez R, Prygiel E, Lesven L, Billon G, Gillan DC. Bacterial metal resistance genes and metal bioavailability in contaminated sediments. *Environ Pollut*, 189 (2014) pp. 143–151. doi: 10.1016/j.envpol.2014.02.031
- [16] Dipu S, Kumar AA, Thanga SG. Effect of chelating agents in phytoremediation of heavy metals. *Remed J*, 22 (2012) pp. 133–146. <https://doi.org/10.1002/rem.21304>
- [17] Lin C, Olson BH. Occurrence of cop-like copper resistance genes among bacteria isolated from a water distribution system. *Can J Microbiol*, 41(2011) pp. 642–646. <https://doi.org/10.1139/m95-087>

- [18] Pereira F, Kerkar S, Krishnan KP. Bacterial response to dynamic metal concentrations in the surface sediments of a solar saltern (Goa, India). *Environ Monit Assess*, 185 (2013), pp. 3625–3636. doi: 10.1007/s10661-012-2814-7.
- [19] Enning D, Garrelfs J. Corrosion of iron by sulfate-reducing bacteria: new views of an old problem. *Appl Environ Microbiol*. 80(4) (2014) pp.1226-36. doi: 10.1128/AEM.02848-13.
- [20] Kakooei S, Che I, Ariwahjoedi B. Mechanisms of Microbiologically Influenced Corrosion: A Review. *World App Sci J*, 17 (2012) pp. 524–531
- [21] Dordevic D, Jancíková S, Vítězová M, Kushkevych I. Hydrogen sulfide toxicity in the gut environment: Meta-analysis of sulfate-reducing and lactic acid bacteria in inflammatory processes. *J Adv Res*, (2020) pp. 1–15. <https://doi.org/10.1016/j.jare.2020.03.003>
- [22] Oyekola OO, van Hille RP, Harrison STL. Study of anaerobic lactate metabolism under biosulfidogenic conditions, *Water Res* 4 (2009) pp.3345–3354. doi: 10.1016/j.watres.2008.11.044
- [23] Sakamoto I, Imaculada Maintinguer S, Sumiko Hirasawa J, Tallarico Adorno MA, Amâncio Varesche MB. Evaluation of microorganisms with sulfidogenic metabolic potential under anaerobic conditions. *Braz arch biol technol*, 55 (2012) pp.779–784. <https://doi.org/10.1590/S1516-89132012000500018>
- [24] Kuang F, Wang J, Yan L, Zhang D. Effects of sulfate-reducing bacteria on the corrosion behavior of carbon steel. *Electrochim Acta*, 52 (2007) pp. 6084–6088. doi: 10.1016/j.electacta.2007.03.041
- [25] Fulaz S, Hiebner D, Barros CHN, Devlin H, Vitale S, Quinn L, Casey E. Ratiometric Imaging of the in Situ pH Distribution of Biofilms by Use of Fluorescent Mesoporous Silica Nanosensors. *ACS Appl. Mater. Interfaces*, 11, 36 (2019) pp. 32679–32688. <https://doi.org/10.1021/acsami.9b09978>
- [26] Wu G, Wan F, Fu H, Li N, Gao H. A Matter of Timing: Contrasting Effects of Hydrogen Sulfide on Oxidative Stress Response in *Shewanella Oneidensis*. *J Bacteriol*, 197(2015) pp. 3563–3572. doi: 10.1128/JB.00603-15
- [27] Manilal VB, Litvin-scramm SB, Suidan MT. Effect of sulphidogenesis on acid-phase digestion of waste activated sludge. *Bioprocess*, 23(2000) pp. 595–597. <https://doi.org/10.1007/s004490000205>
- [28] Utgikar VP, Harmon SM, Chaudhary N, Tabak HH, Govind R, Haines JR. Inhibition of sulfate-reducing bacteria by metal sulfide formation in bioremediation of acid mine drainage. *Environ Toxicol*, 17 (2002) pp. 40–48. doi: 10.1002/tox.10031
- [29] Jin S, Drever JI, Colberg PJS. Effects of copper on sulfate reduction in bacterial consortia enriched from metal-contaminated and uncontaminated sediments. *Environ toxicol Chem*, 26(2) (2007) pp. 225–30. doi: 10.1897/06-190r.1
- [30] Podobas EI, Rożek A. Effect of copper upon the actions of sulphate-reducing bacteria isolated from soil contaminated by crude oil and heavy metals. *Environ Prot Nat Resour*, 4 (2015) pp. 20–25. <https://doi.org/10.1515/oszn-2015-0028>
- [31] Aljerf L, AlMasri N. A Gateway to Metal Resistance: Bacterial Response to Heavy Metal Toxicity in the Biological Environment. *Ann Adv Chem*, 2 (2018) pp. 032–044. <https://doi.org/10.29328/journal.aac.1001012>
- [32] Ismail M, Md Noor N, Yahaya N, Abu Bakar A, Mohd Ali KF, Abdullah A. Statistical Investigation on Anaerobic Sulphate-Reducing Bacteria Growth by Turbidity Method. *Inter J Biol Chem*, 9 (2015) pp. 178–187. doi: 10.1155/2015/178187
- [33] Serrano J, Leiva E. Removal of Arsenic Using Acid/Metal-Tolerant Sulfate Reducing Bacteria: A New Approach for Bioremediation of High-Arsenic Acid Mine Waters. *Water*, 9 (2019) pp. 994. <https://doi.org/10.3390/w9120994>
- [34] Völkel S, Fröls S, Pfeifer F. Heavy Metal Ion Stress on *Halobacterium salinarum* R1 Planktonic Cells and Biofilms. *Front Microbiol*, 9 (2018) pp. 3157. <https://doi.org/10.3389/fmicb.2018.03157>

- [35] Grujić S, Vasić S, Radojević I, Čomić L, Ostojić A. Comparison of the *Rhodotorula mucilaginosa* Biofilm and Planktonic Culture on Heavy Metal Susceptibility and Removal Potential. *Water, Air, & Soil Pollut*, 228 (2017) pp.73. DOI : 10.1007/s11270-017-3259-y
- [36] Al Abbas FM, Williamson C, Bholá SM, Spear JR, Olson DL, Mishra B, Kakpovbia A. Influence of sulfate reducing bacterial biofilm on corrosion behavior of low-alloy, high-strength steel (API-5L X80). *Int Biodeter Biodegr*, 78 (2013) pp. 34–42. <https://doi.org/10.1016/j.ibiod.2012.10.014>
- [37] Edgar JP, Cabrera-Sierra R, González I, Ramírez-Vives F. Influence of *Desulfovibrio* sp. Biofilm on SAE 1018 carbon steel corrosion in synthetic marine medium. *Corros*, 49 (2007) pp. 3580–3597. <https://doi.org/10.1016/j.corsci.2007.03.034>
- [38] Orazem ME, Tribollet B. Constant-phase element. In: *Electrochemical Impedance Spectroscopy*, 2nd ed, John Wiley & Sons (2017) pp. 383–409. ISBN: 978-1-118-52739-9
- [39] Brug GJ, van den Eeden ALG, Sluyters-Rehbach M, Sluyters JH. The analysis of electrode impedances complicated by the presence of a constant phase element. *J Electroanal Chem Interf Electrochem*, 176 (1984) pp. 275–295. DOI:10.1016/S0022-0728(84)80324-1
- [40] Paula MS, Gonçalves MMM, Rola MAC, Maciel DJ, Senna Lf, Lago DCB. Carbon steel corrosion induced by sulphate-reducing bacteria in artificial seawater: electrochemical and morphological characterizations. *Matéria (Rio J)* 21(4) (2016) pp. 987–995. <https://doi.org/10.1590/S1517-707620160004.0091>
- [41] Guan F, Zhai X, Duan J, Zhang M, Hou B. Influence of Sulfate-Reducing Bacteria on the Corrosion Behavior of High Strength Steel EQ70 under Cathodic Polarization. *PLoS One*, 11(9) (2016) e0162315. <https://doi.org/10.1371/journal.pone.0162315>
- [42] Skale S, Doleček V, Slemnik M. Substitution of the constant phase element by Warburg impedance for protective coatings. *Corros Sci*, 49 (2007) pp. 1045–1055. <https://doi.org/10.1016/j.corsci.2006.06.027>
- [43] Permeš S, Lau K, Duncan M. Characterization of Biofilm Formation and Coating Degradation by Electrochemical Impedance Spectroscopy. *Coatings*, 9(8) (2019) pp. 518. <https://doi.org/10.3390/coatings9080518>
- [44] Hansson EB, Odziemkowski MS, Gillham RW. Formation of poorly crystalline iron monosulfides: surface redox reactions on high purity iron, spectroelectrochemical studies. *Corros Sci*, 48 (2006) pp. 3767–3783. <http://dx.doi.org/10.1016/j.corsci.2006.03.010>
- [45] Picard A, Gartman A, Clarke DR, Girguis PR. Sulfate-reducing bacteria influence the nucleation and growth of mackinawite and greigite. *Geochim Cosmochim Acta*, 220 (2018) pp. 367–384. DOI: https://ui.adsabs.harvard.edu/link_gateway/2018GeCoA.220..367P/doi:10.1016/j.gca.2017.10.006
- [46] Balakrishnan A, Rani P. G, Maruthamuthu S, Parvathavarthini N, Muda UK. Corrosion characteristics of sulfate-reducing bacteria (SRB) and the role of molecular biology in SRB studies: an overview. *Corr. Reviews*. 28 (2016) <https://doi.org/10.1515/corrrev-2015-0055>
- [47] Singer M, Brown B, Camancho A, Nesić S. Combined Effect of Carbon Dioxide, Hydrogen Sulfide, and Acetic Acid on Bottom-of-the-Line Corrosion. *Corros*, 67 (2011) 015004–1 to 015004–16. <http://dx.doi.org/10.5006/1.3543715>
- [48] Bondarczuk K, Piotrowska-Seget Z. Molecular basis of active copper resistance mechanisms in Gram-negative bacteria. *Cell Biol Toxicol*, 29 (2013) pp. 397–405. DOI: 10.1007/s10565-013-9262-1
- [49] YuXing S, HongBin C, YuPing L, Yi Z. Effects of sulfide on sulfate reducing bacteria in response to Cu(II), Hg(II) and Cr(VI) toxicity. *Chinese Sci Bull*, 56 (2011) pp.862–868. <https://doi.org/10.1007/s11434-011-4397-z>

[50] Di Martino P. Extracellular polymeric substances, a key element in understanding biofilm phenotype. *AIMS Microbiol.* 4(2) (2018) pp. 274–288. doi: 10.3934/microbiol.2018.2.274

[51] Cabrera G, Perez R, Gomez JM, Abalos A, Cantero D, Toxic effects of dissolved heavy metals on *Desulfovibrio vulgaris* and *Desulfovibrio* sp. Strains. *J. of Hazardous Materials* 135 (2006) pp. 40-46. doi: 10.1016/j.jhazmat.2005.11.058

[52] Belkaid S, Laadjouzi M.A, Hamdani S. Effect of biofilm on naval steel corrosion in natural seawater. *J Solid State Electrochem* 15 (2011) pp.525–537. DOI 10.1007/s10008-010-1118-5

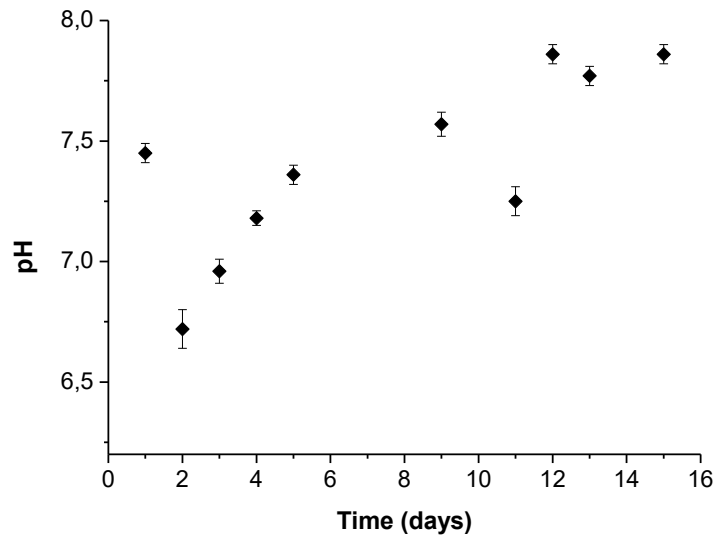

Fig.1 pH evolution in nutrient rich-simulated seawater inoculated with SRB without cuprous ions.

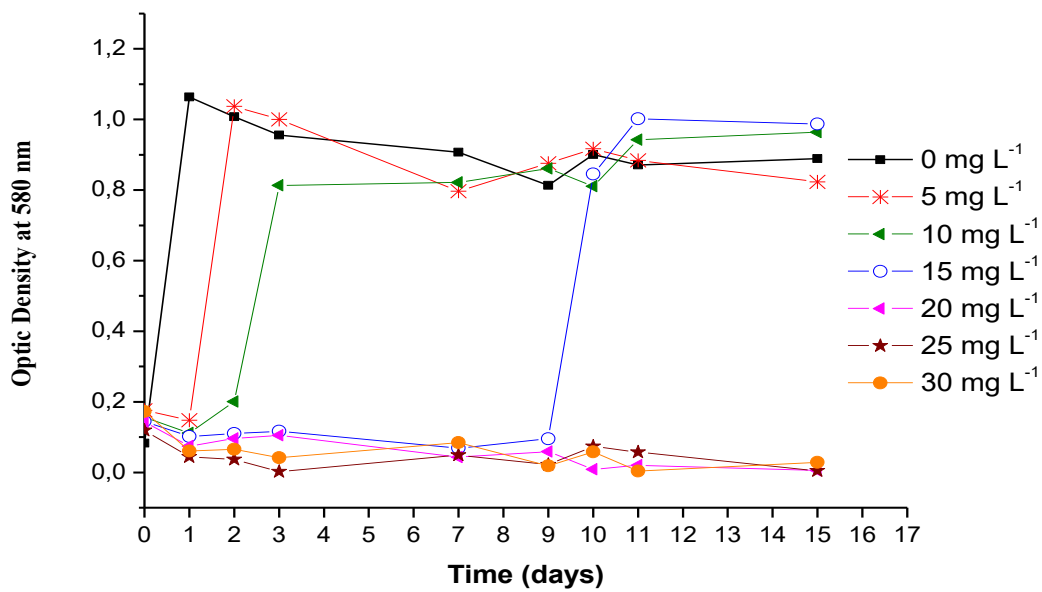

Fig. 2 Growth of sulphate-reducing bacteria consortium in nutrient rich-simulated seawater at increasing concentrations of Cuprous ions

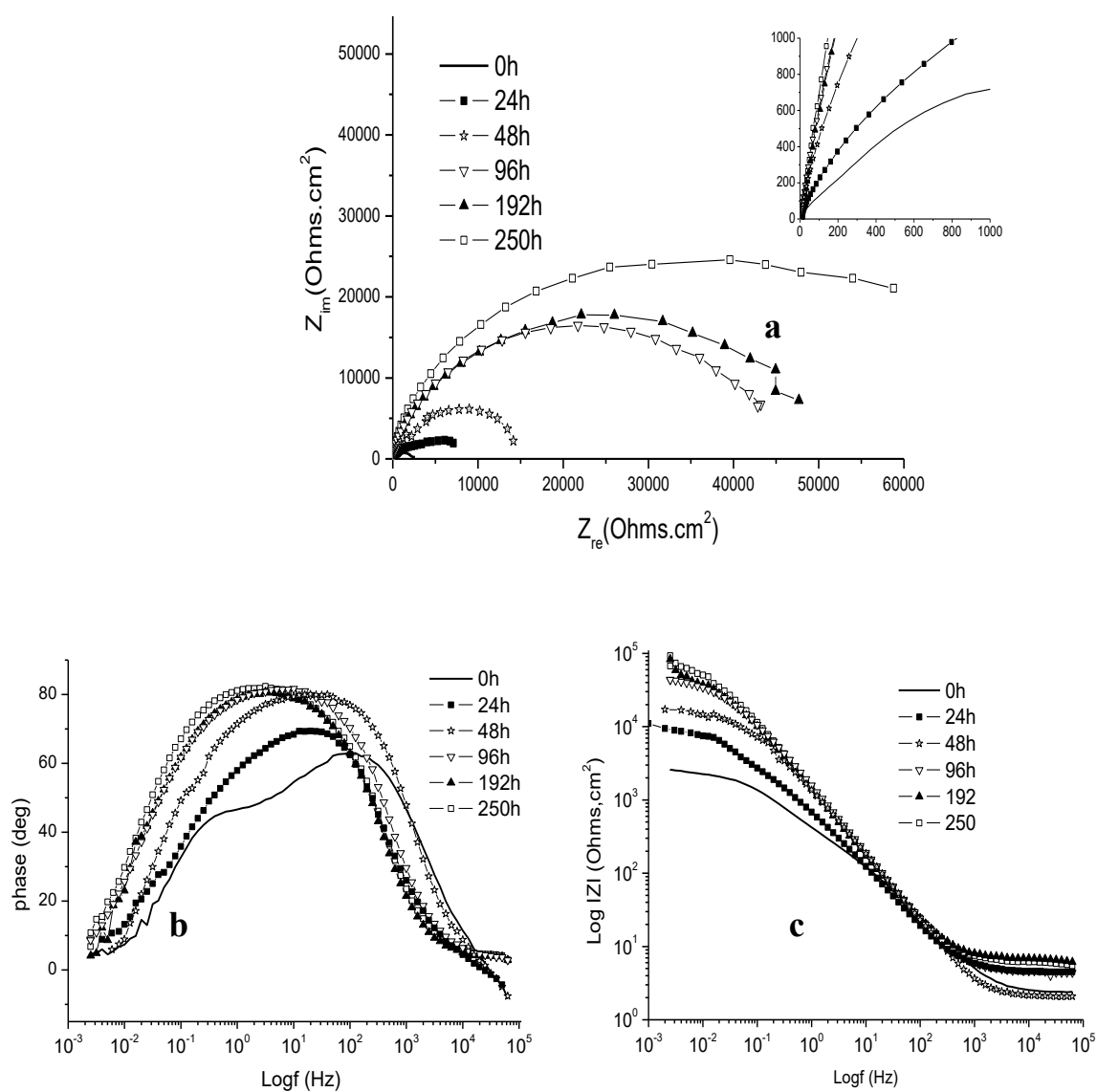

Fig. 3 Impedance plots of BV-grade A carbon steel in the sterile nutrient-rich simulated seawater for different exposure times: **a** Nyquist plots, **b** and **c** Bodes plots.

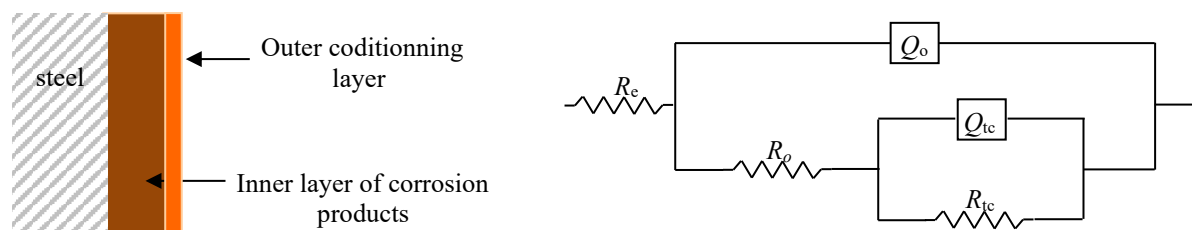

Fig. 4 Physical models and the corresponding equivalent circuit used for fitting the impedance spectra of carbon steel in the sterile medium: circuit ($R_c, (Q_o // (R_o, (Q_{ic} // R_{ic})))$).

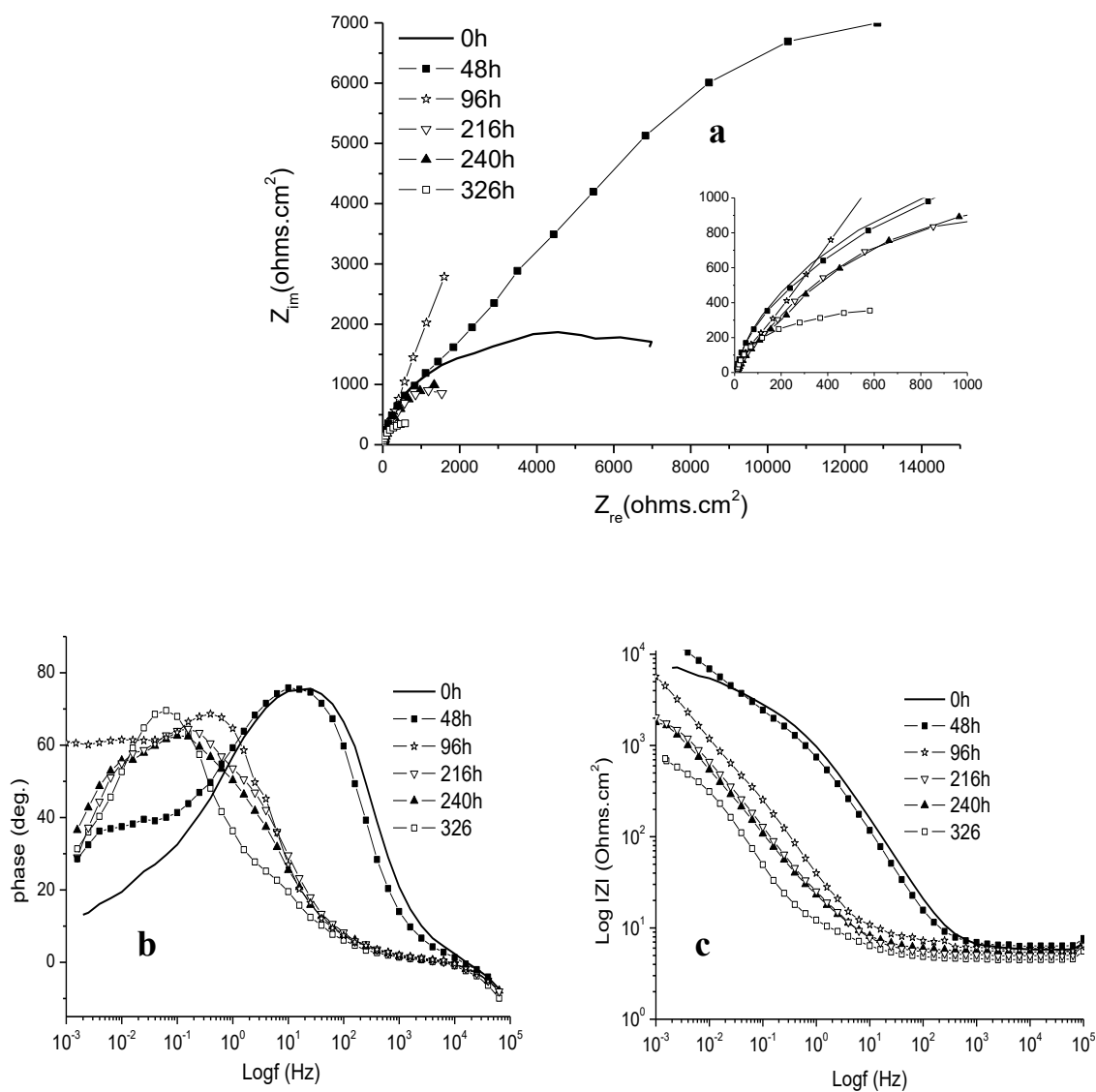

Fig. 5 Impedance plots of BV-grade A carbon steel in SRB inoculated medium in absence of Cu^+ ions:
a - Nyquist plots, **b** and **c** - Bodes plots.

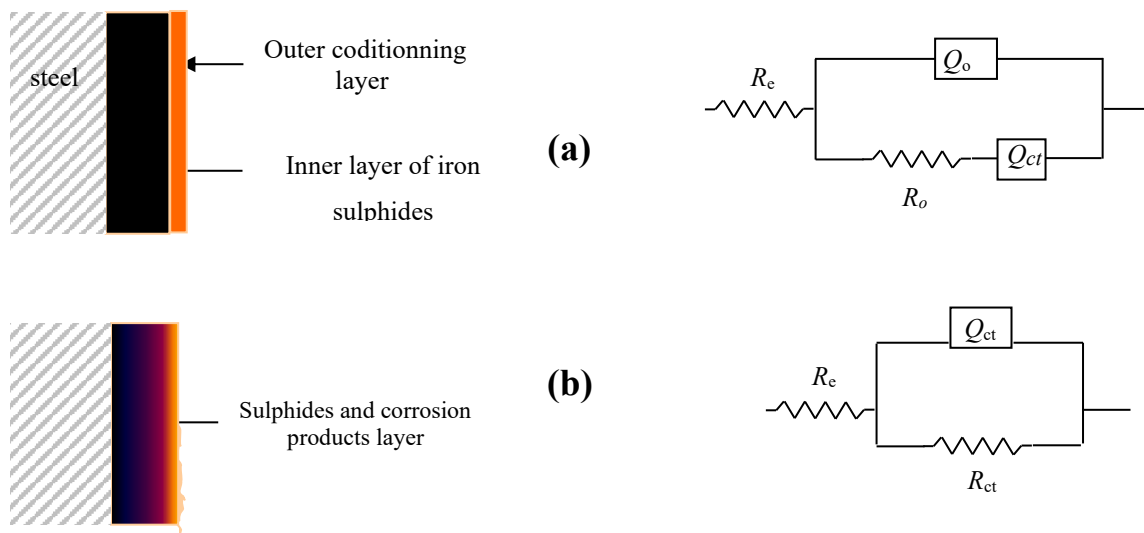

Fig. 6 Physical models and the corresponding equivalent circuits used for fitting the impedance spectra of carbon steel in SRB inoculated medium: **a** - circuit ($R_e, (Q_o // (R_o, Q_{ct}))$) and **b** - circuit ($R_e, (Q_o // Q_{ct})$)

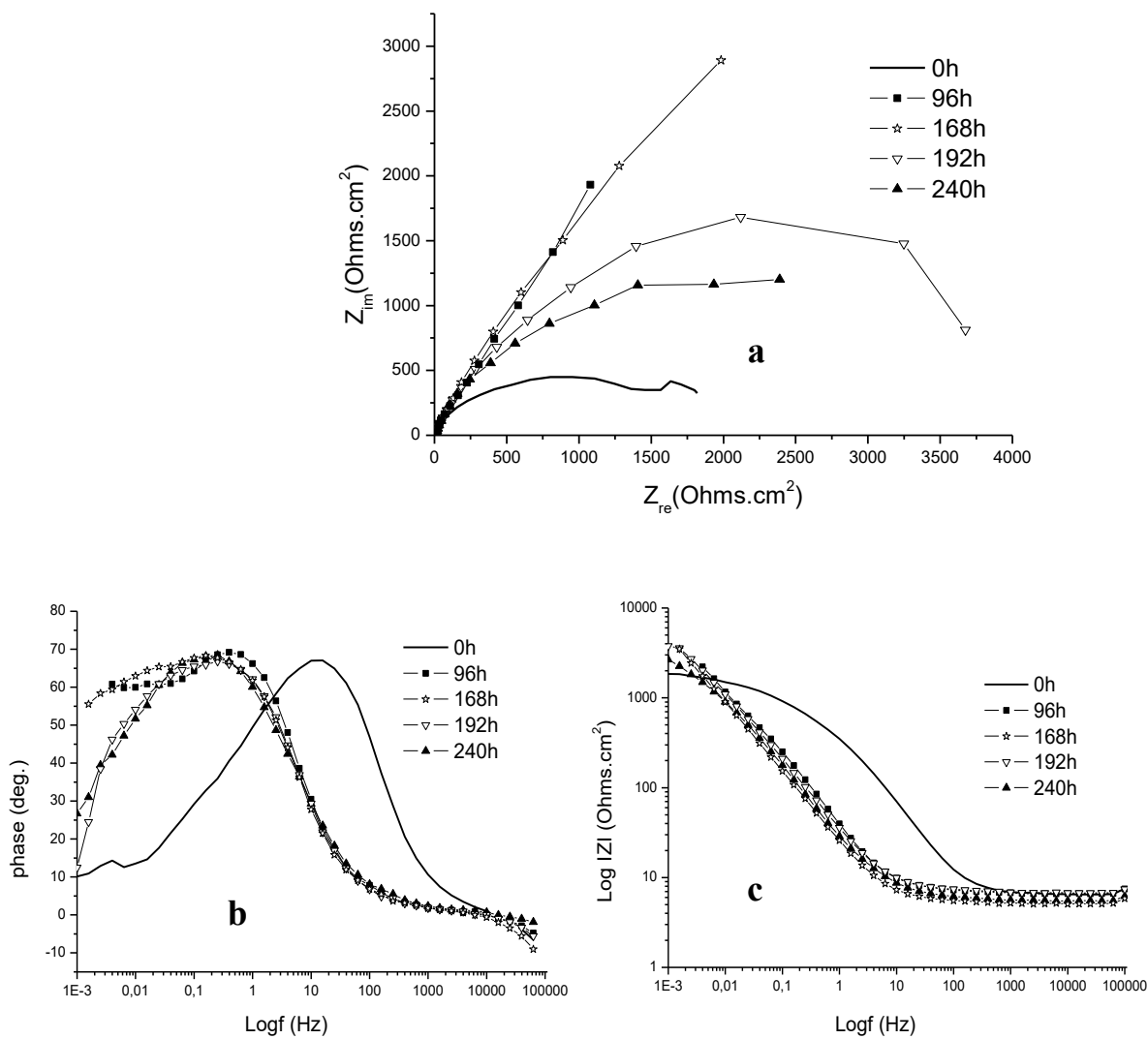

Fig. 7 Impedance plots of BV-grade A carbon steel in SRB inoculated medium in addition of Cu^+ ions at 15 ppm concentration: **a** Nyquist plots, **b** and **c** Bodes plots.

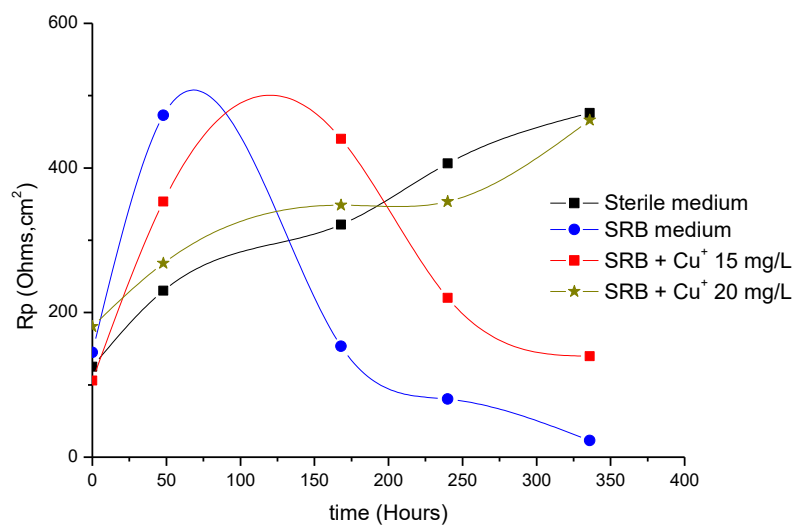
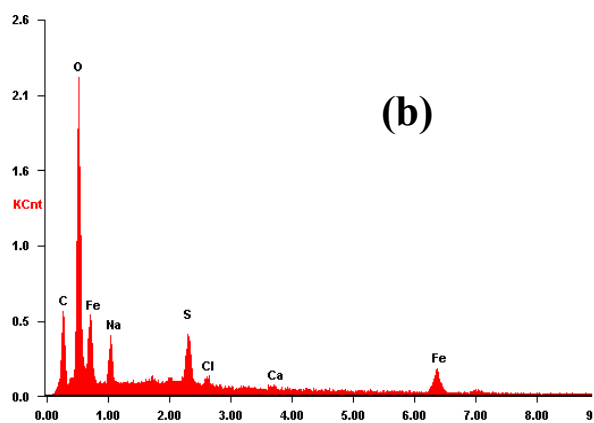
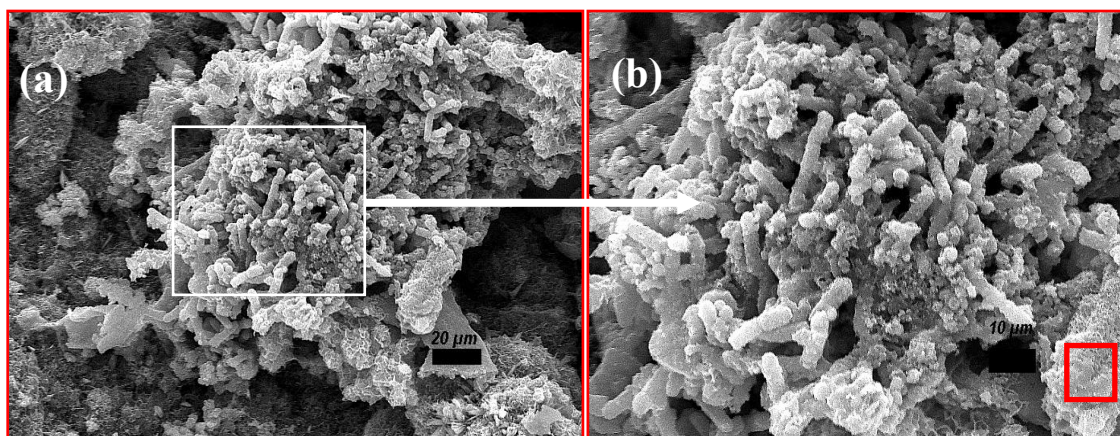

Fig.8 Polarisation resistance values of steel in different studied environments.



Element	C	O	Na	S	Cl	Ca	Fe
Atomi c%	28.28	44.64	03.67	03.88	00.89	00.54	18.10

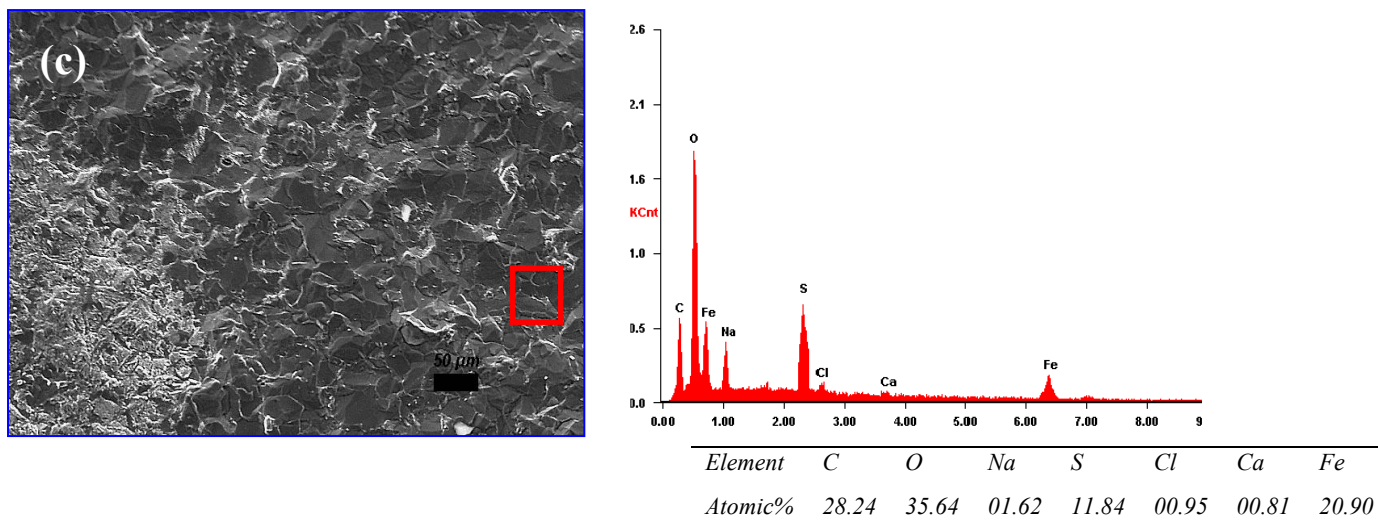
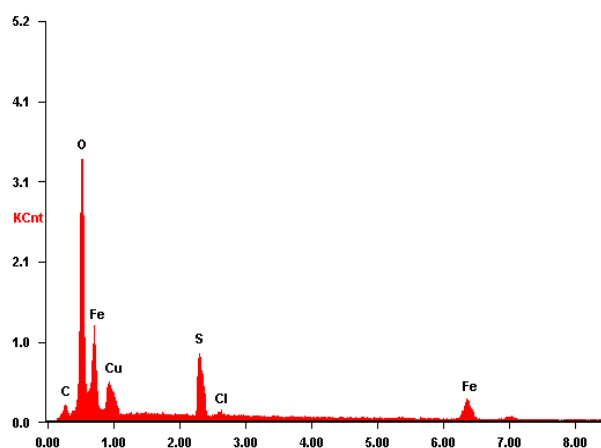
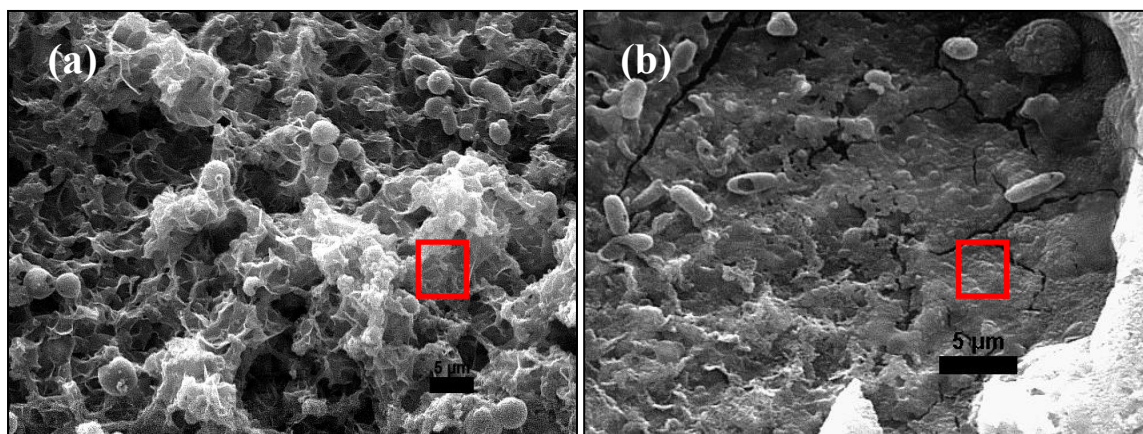
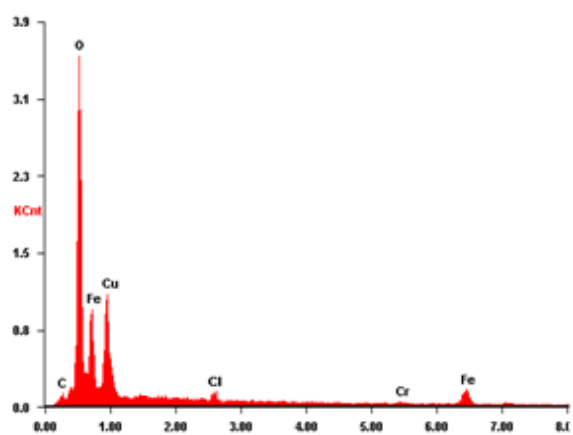

Fig. 9 Scanning electron microscopy and EDS analysis showing SRB marine biofilm structure: **a** – biofilm in EPS matrix, **b**- Enlargement of biofilm, **c**- sulphides iron layer.



Element	C	O	Cu	S	Cl	Fe
Atomi c%	12.67	45.32	04.43	10.97	00.80	25.81



Element	C	O	Cu	Cl	Cr	Fe
Atomi c%	05.56	64.72	09.86	01.38	00.80	17.68

Fig. 10 Scanning electron microscopy and EDS analysis showing SRB marine biofilm structure: **a** – SRB in the presence of 15 mg/L Cu^+ , **b**- SRB in presence of 20 mg/L Cu^+

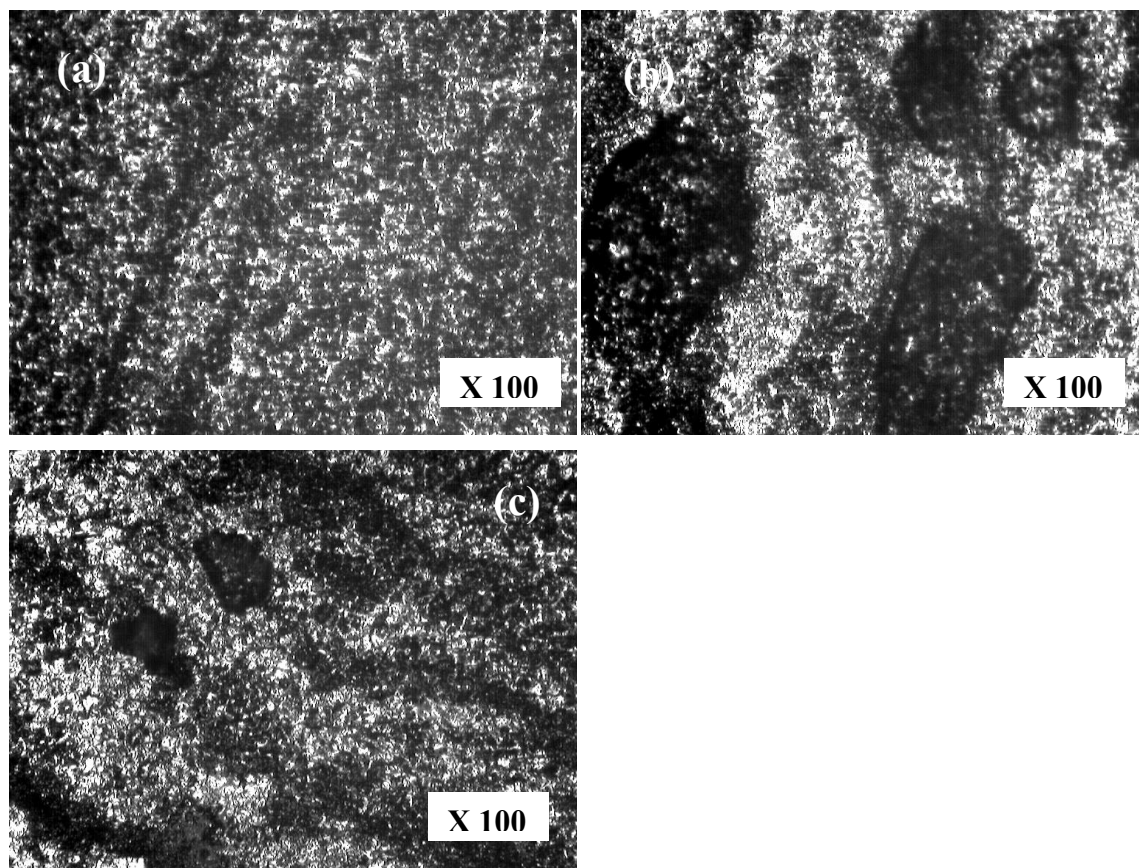

Fig. 11 Optic microscope images of the corroded surfaces after removal of the corrosion products layer in: **a** - sterile simulated seawater, **b** - simulated seawater inoculated by SRB. **c**- simulated seawater inoculated by SRB with 15 mg/L Cu^+ .

Time (hours)	0	24	48	96	192	250
Equivalent circuit	$(R_e, (Q_o // (R_o, (Q_{tc} // R_{tc}))))$					
R_e ($\Omega \text{ cm}^2$)	2.74	4.64	2.23	4.53	6.91	7.03
R_o ($\text{K}\Omega \text{ cm}^2$)	0.166	0.651	5.38	27.06	35.09	51.10
n_o	0.84	0.87	0.91	0.91	0.89	0.91
Q_o ($\Omega^{-1} \text{ cm}^{-2} \text{ s}^n$)	$1.63 \cdot 10^{-4}$	$1.99 \cdot 10^{-4}$	$1.20 \cdot 10^{-4}$	$1.20 \cdot 10^{-4}$	$1.36 \cdot 10^{-4}$	$1.25 \cdot 10^{-4}$
C_o ($\mu\text{F cm}^{-2}$)	81.95	146.63	114.97	134.82	164.97	150.16
R_{ct} ($\text{K}\Omega \text{ cm}^2$)	2.24	10.09	10.14	17.46	26.81	21.31
n_{ct}	0.70	0.58	0.75	0.80	0.80	0.86
Q_{ct} ($\Omega^{-1} \text{ cm}^{-2} \text{ s}^n$)	$4.99 \cdot 10^{-4}$	$2.71 \cdot 10^{-4}$	$1.27 \cdot 10^{-4}$	$2.62 \cdot 10^{-4}$	$2.43 \cdot 10^{-4}$	$2.1 \cdot 10^{-4}$
C_{ct} ($\mu\text{F cm}^{-2}$)	523.38	561.45	138.17	383.16	388.22	268.01

Table 1 Fitting parameters of impedance spectra of BV-grade A carbon steel in sterile medium using the electric circuit of Fig.4.

Time (hours)	0	48	96	216	240	326
Equivalent circuits	$(R_e, (Q_o // (R_o, (Q_{tc} // R_{tc}))))$		$(R_e, (Q_o // (R_o, Q_{ct})))$		$(R_e, (Q_o // Q_{ct}))$	
R_e ($\Omega \text{ cm}^2$)	5.54	5.72	6.15	5.15	5.66	4.79
R_o ($\text{K}\Omega \text{ cm}^2$)	1.567	1.570	2318	-	-	-
n_o	0.90	0.90	0.79	-	-	-
Q_o ($\Omega^{-1} \text{ cm}^{-2} \text{ s}^n$)	$1.47 \cdot 10^{-4}$	$2.04 \cdot 10^{-4}$	$5.86 \cdot 10^{-3}$	-	-	-
C_o ($\mu\text{F cm}^{-2}$)	121.81	259.62	11724.05	-	-	-
R_{ct} ($\text{K}\Omega \text{ cm}^2$)	8.268	31.21	-	2.764	3.030	1.095
n_{ct}	0.52	0.56	0.61	0.75	0.73	0.75
Q_{ct} ($\Omega^{-1} \text{ cm}^{-2} \text{ s}^n$)	$5.3 \cdot 10^{-4}$	$6.64 \cdot 10^{-4}$	$1.90 \cdot 10^{-3}$	$1.08 \cdot 10^{-2}$	$1.2 \cdot 10^{-2}$	$2.6 \cdot 10^{-2}$
C_{ct} (mF cm^{-2})	2.072	7.186	-	33.50	45.33	79.39

Table 2 Fitting parameters of impedance spectra of BV-grade A carbon steel in SRB inoculated medium without Cu^+ and using the electric circuits of Fig.4 and Fig.6

Time (hours)	0	96	168	192	240
Equivalent circuits	$(R_e, (Q_o // (R_o, (Q_{ic} // R_{ic}))))$	$(R_e, (Q_o // (R_o, Q_{ct})))$	$(R_e, (Q_o // Q_{ct}))$		
R_e (Ω cm ²)	6.26	6.58	5.21	6.89	5.70
R_o ($K\Omega$ cm ²)	0.596	1.690	2.444	-	-
n_o	0.85	0.82	0.81	-	-
Q_o (Ω^{-1} cm ⁻² s ⁿ)	$4.15 \cdot 10^{-4}$	$5.78 \cdot 10^{-3}$	$9.22 \cdot 10^{-3}$	-	-
C_o (mF cm ⁻²)	0.324	9.532	19.145	-	-
R_{ct} ($K\Omega$ cm ²)	1.459	-	-	4.530	3.081
n_{ct}	0.54	0.68	0.48	0.79	0.78
Q_{ct} (Ω^{-1} cm ⁻² s ⁿ)	$1.97 \cdot 10^{-3}$	$3.20 \cdot 10^{-3}$	$1.72 \cdot 10^{-2}$	$6.9 \cdot 10^{-3}$	$8.4 \cdot 10^{-3}$
C_{ct} (mF cm ⁻²)	4.842	-	-	17.228	24.846

Table 3 Fitting parameters of impedance spectra of BV-grade A carbon steel in SRB inoculated medium in presence of Cu⁺ ions at 15 ppm.