



HAL
open science

Design of Green IS for electric systems: An information flow perspective

Diego Cebreros, Jan Lepoutre, Yannick Perez

► **To cite this version:**

Diego Cebreros, Jan Lepoutre, Yannick Perez. Design of Green IS for electric systems: An information flow perspective. 2023. hal-04322910

HAL Id: hal-04322910

<https://hal.science/hal-04322910v1>

Preprint submitted on 5 Dec 2023

HAL is a multi-disciplinary open access archive for the deposit and dissemination of scientific research documents, whether they are published or not. The documents may come from teaching and research institutions in France or abroad, or from public or private research centers.

L'archive ouverte pluridisciplinaire **HAL**, est destinée au dépôt et à la diffusion de documents scientifiques de niveau recherche, publiés ou non, émanant des établissements d'enseignement et de recherche français ou étrangers, des laboratoires publics ou privés.

Design of Green IS for electric systems: An information flow perspective.

Diego Cebreros^{a,*,1}, Jan Lepoutre^{b,1}, Yannick Perez^{a,1}

^a *Chaire Armand Peugeot, Université Paris-Saclay, CentraleSupélec, Laboratoire de Génie Industriel, 91190, Gif-sur-Yvette, France*

^b *Chaire Armand Peugeot, ESSEC Business School, Management Department, Cergy, France*

Abstract:

This paper delves into the subdomain of Energy Informatics and aims to study the design of Green IS for electric systems. We contend that essential differences in the physical and economic characteristics between electric and other energy systems require special considerations in designing their IS. We develop an analytical framework to construct and evaluate Green IS information flow representation. We apply the analytical framework to a specific Green IS application: Vehicle-to-Grid (V2G), a socio-technical system enabling the use of Electric Vehicles (EVs) as energy storage. The study of V2G information flow unveils their design rules and the need for additional actor categories that have not been previously considered in energy informatics, highlighting new research directions in the design of Green IS for electricity systems.

Keywords: *Complexity; Design science research; Electric vehicles; Energy systems; Green Information Systems (Green IS); Information systems (IS); Vehicle-to-Grid (V2G); Wicked problems.*

*Corresponding author.

E-mail addresses: dcebreros@gmail.com (D. Cebreros), lepoutre@essec.edu (J. Lepoutre), yannick.perez@centralesupelec.fr (Y. Perez)

¹D. Cebreros, J. Lepoutre and Y. Perez benefit from the support of the Chair ‘PSA Peugeot Citroen Automobile: Hybrid technologies and Economy of Electromobility, so-called Armand Peugeot Chair’ led by CentraleSupélec and ESSEC business school and sponsored by Stellantis Group. The funding source was not involved in the writing of the report or the decision of submitting the article.

1. Introduction

The design and analysis of Green Information Systems (Green IS) is an important and emerging area of research (Watson, 2008; Watson et al., 2010; Dedrick, 2010; Malhotra & Hill, 2013; Gholami et al., 2016). Green IS assists in generating, exchanging, and analyzing information to improve economic and environmental sustainability (Dedrick, 2010). One domain where Green IS has been studied because it has been proven particularly relevant for ecological sustainability is their applications to energy systems' sustainability.

Energy informatics is a subdomain in Information Systems (IS) research that studies Green IS on energy systems (Watson et al., 2010). Its main objective is to study how Green IS can enable the optimal level of information for the stakeholders of an energy system (Watson et al., 2010). The underlying assumption that motivates this research domain is that if the correct information is available to the stakeholders of an energy system, it will improve its economic and environmental decision-making (Watson et al., 2010). In energy informatics, Watson et al. (2010) propose to analyze how an IS can integrate the optimal granularity of supply and demand data to increase the efficiency of an energy system. However, in IS, how an IS integrates supply and demand data is specified in design artifacts, which are the blueprints that define the work, organization, and resources required to support the exchange and analysis of information for a specific purpose (Chen & Nunamaker, 1991; Hevner et al., 2004). Therefore, if we want to know how to integrate the optimal granularity of supply and demand data, we need to be able to answer the following question: *How to design Green IS on energy systems?*

This research aims to study the design of Green IS for a sub-type of energy systems: electric systems. We justify our scope because we contend that essential differences in the physical and economic characteristics between electric and other energy systems require special considerations in designing their IS. Most notably, these differences are two: first, the transmission of electricity follows particular laws that require quick reactions from the system operator to balance supply with demand (the transmission of electricity follows Kirchoff laws of current, which implies that supply, demand, and losses need to be balanced according to the grid capacity to have efficient transmission of electricity), and second the creation of regulated power markets to exchange energy that has been design for large-centralized generation units. Furthermore, given the global efforts to decarbonize energy systems, several industries and systems are being electrified to take advantage of decarbonized energy sources such as solar or wind. Therefore, it is crucial to analyze how to maximize the potential value created by integrating Green IS into electric systems (Ketter et al., 2022, 2018).

We develop an analytical framework to construct and evaluate the representation of IS design artifacts. The framework relies on identifying information tasks and the actors performing them in scientific publications to build a standard representation of an IS information flow. We contend that the information flow provides us with several examples of how IS can aggregate and enable the optimal level of information for the stakeholders of an energy system (Watson et al., 2010). Then, we use the standard structure of the information flow to compare the design amongst publications, aiming to provide insights into the IS design process. Indeed, according to Hevner et al. (2004), there is an interplay between scientific knowledge influencing design artifacts and design artifacts affecting scientific knowledge. Thus, understanding the theoretical design assumptions is central to understanding how to design Green IS. To derive insights into the design of Green IS in electric systems, we apply the analytical framework to a specific Green IS application: Vehicle-to-Grid (V2G), a socio-technical system enabling the management of the energy demand and supply from Electric Vehicles (EVs). It is an interesting case to study because it challenges the current design of electric systems. Under V2G, the batteries in the EVs can be used as sources of electricity storage, allowing them to coordinate their charge with the supply of

electricity from renewable energies, but also to discharge them in times of lower intermittent renewable energy production, avoiding the production of electricity from fossil fuels (Kempton & Tomić, 2005; Lund & Kempton, 2008; Turton & Moura, 2008).

Our analysis of V2G shows that to design Green IS for electricity systems, two sets of actors need to be added to the ones considered in Watson's framework: prosumers and aggregators. Designing green V2G systems requires specifically integrating these types of actors. By analyzing the current V2G literature, we also find that the current literature has not paid attention to the information flows necessary to optimize green V2G. From this analysis, we can derive avenues for future research in Green IS for electricity systems, and therefore, Green IS, but also new design criteria for making V2G systems possible.

This paper is structured in six sections. In the next section, we describe the research framing Green IS's design for energy systems. Then, we explain why the design of electric systems requires special consideration and set the V2G application as an essential design problem after introducing the analytical framework and results from the V2G Green IS design analysis. Further, we discuss the analysis results and provide new research questions to further the research agenda on Green IS integration on electric systems—finally, the conclusions.

2. Design of Green IS for energy systems

In search of solving environmental challenges, the Green IS discipline orients its efforts to investigate the design and use of IS to facilitate sustainability transformation (Melville, 2010; Elliot, 2011; Gholami et al., 2016). In the case of energy systems, their environmental sustainability scope is far beyond a single organization and requires an understanding of the interdependencies between the system's performance and its environment (Watson et al., 2010). In their seminal work, Watson et al. (2010) define three relevant components in a Green IS on energy system: a *flow network* that are the transport components that support the distribution and consumption of energy – e.g., transmission grids for electricity or pipelines to transport biogas, gas, hydrogen, heat, etc; a *sensor network* which are distributed devices that reports the status of a physical item or environmental condition; and *sensitized objects* which are the physical good that a consumer owns or manages to exchange and control their data.

Watson et al. (2010) propose that IS be designed to enable and motivate environment-efficient solutions to an energy system's stakeholders: consumers, suppliers, and government. An IS should tie together all three components of a Green IS on an energy system and enable each stakeholder to receive the information to improve its environmental decision-making. From the interaction between the stakeholders and components, Watson et al. (2010) propose nine research questions that IS scholars should analyze to understand how an IS could optimally manage an energy system's supply and demand (Table 1).

Table 1

Watson et al. (2010) research question matrix.

| Stakeholders | Energy system components | | | Information System |
|--------------|--|---|--------------------|---|
| | Sensor Network | Flow Network | Sensitized objects | |
| Suppliers | What is the optimum level of information granularity of the sensor network to optimize a given flow network? | What information, and at what level of granularity, is required to optimize a given type of flow network? | | How can an information system integrate supply and demand data to increase energy efficiency? |

| Stakeholders | Energy system components | | | Information System |
|--------------|--|---|---|--|
| | Sensor Network | Flow Network | Sensitized objects | |
| Consumers | | | What information do consumers need about the usage of the objects they own to manage to increase their energy efficiency? | How can information systems be used to change social norms to increase energy efficiency? |
| Governments | What information granularity enables effective enforcement of energy policy? | <p>What government policies and regulations will impel flow network managers to make them more energy efficient?</p> <p>What government policies and regulations will impel flow network consumers to shift to more energy-efficient networks or radically reduce the energy consumption patterns of specific networks?</p> | | What data should be reported by an energy information system to inform governments' energy policies? |

Answering the research questions from Table 1 requires, as Watson et al. (2010) suggest, that IS scholars apply the principles of DSR to develop a deeper understanding of how IS should be designed to enable the optimal level of information to be aggregated for stakeholders. From an IS perspective, DSR is the framework to address the construction and evaluation of IS design artifacts: a blueprint that defines the work, organization, and resources required to support the exchange and analysis of information for a specific purpose (Chen & Nunamaker, 1991; Hevner et al., 2004).

Figure 1
Design as a three-cycle search process (Hevner, 2007)

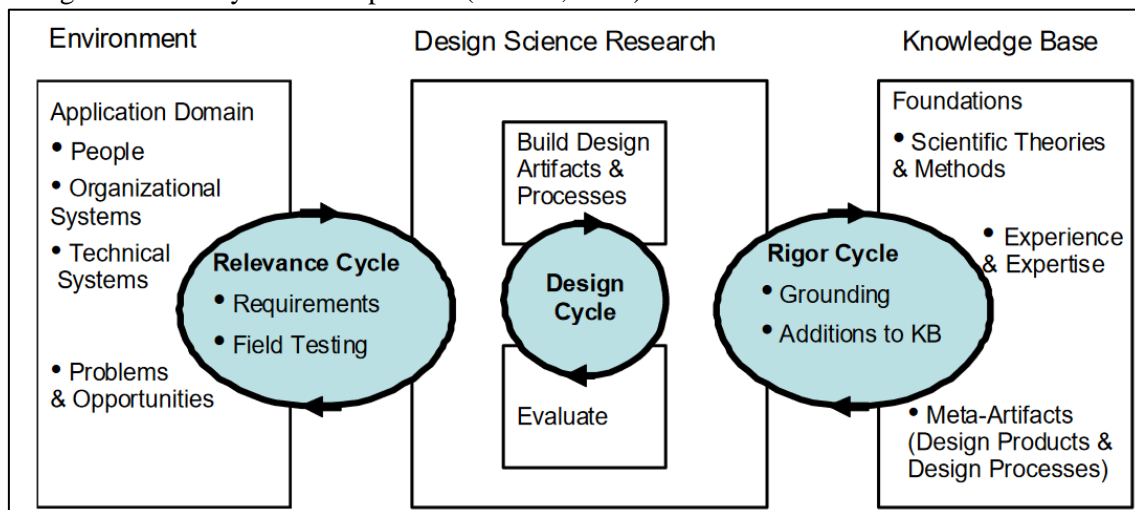

In their seminal work, Hevner et al. (2004; 2007) propose conceptualizing design as an inherently iterative search process that connects three types of cycles, as shown in Figure 1. Using DSR principles as a lens to respond to energy informatics research questions requires acknowledging that IS are purportedly created artifacts for a specified problem. In the case of energy informatics questions, the problem that Green IS proposes to solve is to improve energy systems' environmental sustainability. Therefore, answering energy informatics questions requires us to

understand the design process required to provide a more effective way to solve energy systems' current management, enabling more and better information.

3. Why do we need special considerations to design Green IS on electric systems?

We need special considerations to design Green IS on electric systems because specific technical and economic forces shape them. As Watson et al. (2010) suggest, considering external forces is essential to all energy systems on Green IS design. Therefore, our objective in this section is first to describe the technical and economic forces that differentiate electric systems from other energy systems. Then, we problematize the interaction between these forces by analyzing the application of Green IS on energy systems technologies.

3.1. Forces shaping electric systems

Figure 2 summarizes the main forces. Furthermore, we have organized them according to their relevance. We distinguish between the fundamental forces derived from the knowledge base of the physics of electricity systems and the economic forces derived from the solutions that economists, engineers, and policymakers have proposed to address the fundamental characteristics of electric systems design. The more fundamental the force, the more it might be relevant as a factor in Green IS design.

Figure 2

Forces affecting the design of electric systems (Authors).

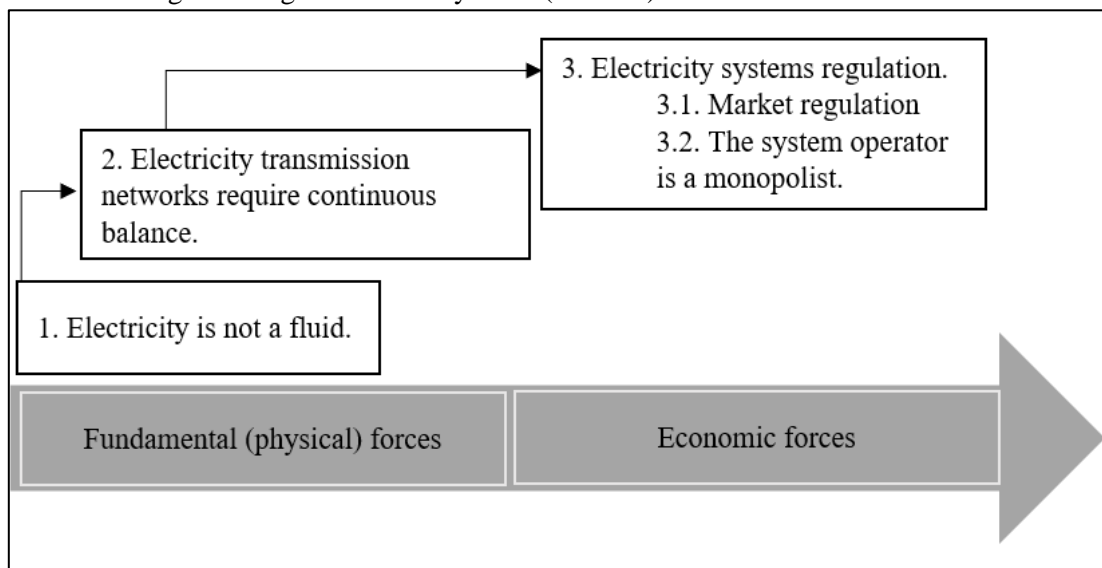

Shaping Force (SF) 1: Electricity is not a fluid. The Cambridge Dictionary defines electricity as “a form of energy that can be produced in several ways, and that provides power to devices that create light, heat, etc...”. In Ørsted transformative paper published in 1821 studying electromagnetism, he showed that the action of the force of an electric current in the magnet does not depend on the direction nor the substance but instead in the movement of charged particles (i.e., electric current) (Meyer, 1931). In contrast, most non-electric energy systems, such as those that transport gas or liquids, require the fluid to perform work, while on an electric system, work is done when a charge is moved in an electric field (Smythe, 1988). Therefore, in energy systems where the work depends on the fluid, the network flow is uni-directional, from upstream, where the fluid is pumped, to downstream, where the fluid is consumed, while in electric systems, the work can be both consume and produce in all parts of the electric systems, as long the current laws are respected.

SF 2: Electric transmission and distribution networks require continuous balance. Derived from SF 1, electricity can only be delivered by wires, and Kirchhoff's current laws govern the efficiency of transmitting electricity through wires (Sorokin et al., 2012). According to Kirchhoff's circuit laws, the algebraic sum of the power flow (all electric currents entering and exiting) in a network node must equal zero (Smythe, 1988). Therefore, the transmission and distribution networks require that electricity production is balanced with power consumption and losses.

SF 3: Electricity systems regulation. One must understand the liberalization reforms during the late 80s and early 90s to understand electric systems' organization today. The objective of liberalization for the electric industry was to ensure that prices reflect "*the efficient economic cost of supplying electricity and service quality attributes that reflect consumer valuations*" (Joskow, 2008). Before, electric systems were dominated by vertically integrated monopolies that had overall authority and control of the assets and information of electric systems. After the liberalization reforms, most electric systems were divided into four segments: Generation and Retail supply, where competition was introduced through power markets, and transmission and distribution, which were kept as natural monopolies. We will expand more on these two approaches below.

SF 3.1. Markets regulation. Separating the generation and retail as competitive segments relies on creating competitive wholesale power markets. These markets created through regulatory reforms enable retailers, which aggregate the demand from several consumers, to buy power at a marginal price (Joskow, 2008).

The ideal market regulations, from an economic point of view, are those that enable all products and services to be efficiently priced by the marketplace, which requires that their design follows some principles: time electricity prices are determined at a very granular temporal level; space, price should reflect how demand or costs differ across locations; carbon emissions and air pollutants should be priced (Newbery et al., 2018). Nevertheless, various political and institutional constraints exist around the market design application of these principles, which creates market failures in most power market designs (Newbery et al., 2018).

SF 3.2.: System operator is a monopolist. Because of SF2, the transmission and distribution of electricity have been reformed differently than the generation and retail segments, under the assumption that markets will not be able to provide as efficiently the service of balancing the electric grid and following Kirchhoff's current law. In particular, economists deemed that operating the network infrastructure requires rapid responses to unanticipated failures or changes in supply or demand to continue to meet the optimal network requirements (Joskow & Tirole, 2007). Therefore, Independent System Operators (ISO), Transmission System Operators (TSO), and Distribution System Operators (DSO) were endowed with a regulatory framework to act as responsible for the electric grid operation and coordinate the dispatch of energy that is derived from the auctions in power markets, only if it does not pose a risk to follow the physical constraints of the electric grids.

The forces shaping electric systems are currently design principles for exchanging and using information in electric systems. Indeed, information from the physical components of the electric grid is aggregated by the system operators, while information on demand and supply is aggregated in power markets. In this context, the uptake of information and communication technologies (ICT) on electric equipment and the reduction in costs of distributed energy resources (DER) such as rooftop solar panels and small battery storage might challenge these principles, enabling a decentralized operation of the electric grid and creating tension between the current paradigm on IS, and the adoption of new types of DER. For example, instead of centralized supply following demand, Green IS might simultaneously turn the electricity system into a more complex set of interactions driven by actors performing both supply and demand (Burger et al., 2019).

Consequently, for the design of Green IS on an electric system, we should ask ourselves how Green IS can harness the forces shaping an electric system and provide a more effective way to improve the sustainability of the system.

3.2. *V2G as a Green IS design problem*

Vehicle-to-Grid (V2G) has received interest from the industry, the academic literature, and governments as an essential technological solution that can address energy storage needs. Enabled by information communication technologies within the EV and electric grid – “smart grid”- it allows the coordination of the charge or discharge of several EVs, using their batteries as distributed sources of energy storage (Kempton & Tomić, 2005; Lund & Kempton, 2008; Turton & Moura, 2008). Suppose the coordination is done to achieve electric grid decarbonization. In that case, it might reduce the need to install additional battery energy storage systems and reduce greenhouse gas emissions while being economically attractive to EV users (Andreotti et al., 2012; Parag & Sovacool, 2016; Chandra Mouli et al., 2019; Zheng et al., 2019).

There is consensus among practitioners and within the academic literature that V2G complexity is one of the main issues as to why there is still no commercial business model that can deliver V2G at a large scale (Gschwendtner et al., 2021; Sovacool et al., 2020). The efforts to manage the complexity and develop new business models from the practitioners have occasioned several pilot programs developed by joint ventures. Indeed, there are currently more than 128 V2G pilot projects worldwide (V2G Data Hub, 2023).

The complexity of V2G is driven by the numerous stakeholders that might be involved in the V2G flow network, which consists of at least three interdependent components involved in the optimization: the electricity grid, the electric vehicle supply equipment (EVSE), and the EV. Different stakeholders control the components within V2G, which might influence the architecture, function, and goals of the IS that will enable the optimization of the energy system.

In Figure 3, we have laid out V2G complexity from a supply and demand perspective. From the supply side, IS should enable the grid system operator to manage the electricity grid according to the physical constraints given by the Kirchhoff law. Therefore, V2G requires that information on the state of EVs and the Electric Vehicle Supply Equipment (EVSE) be dynamically exchanged with the grid operator to guarantee the safe operation of the electricity grid. Indeed, given the distributed nature of EVs and individually little power compared to most generators in the electricity market, EVs can supply energy to the grid only through aggregation (Borne et al., 2018). Aggregation allows to “bulk” the energy from several EVs but imposes complexity that the IS needs to manage. It requires that the IS communicates the data sent from different types of EVs, potentially located at different places, connected to different types of EVSEs, with EV owners with several driving needs. From the demand side, the IS should enable EV users to react to the production of renewable while avoiding the creation of peaks in EV energy demand. Therefore, the IS needs to incentivize EV owners to spread their charge. Even more, the IS should consider that EV owners might charge at different places and with different types of use cases. EV owners might charge at home, in public EVSEs, or semi-public EVSEs. The EVSE might be operated by an operator that provides the charging service and will most probably manage the relationship directly with the EV users and affect the final price of electricity directly.

Figure 3
V2G as an energy supply and demand optimization problem

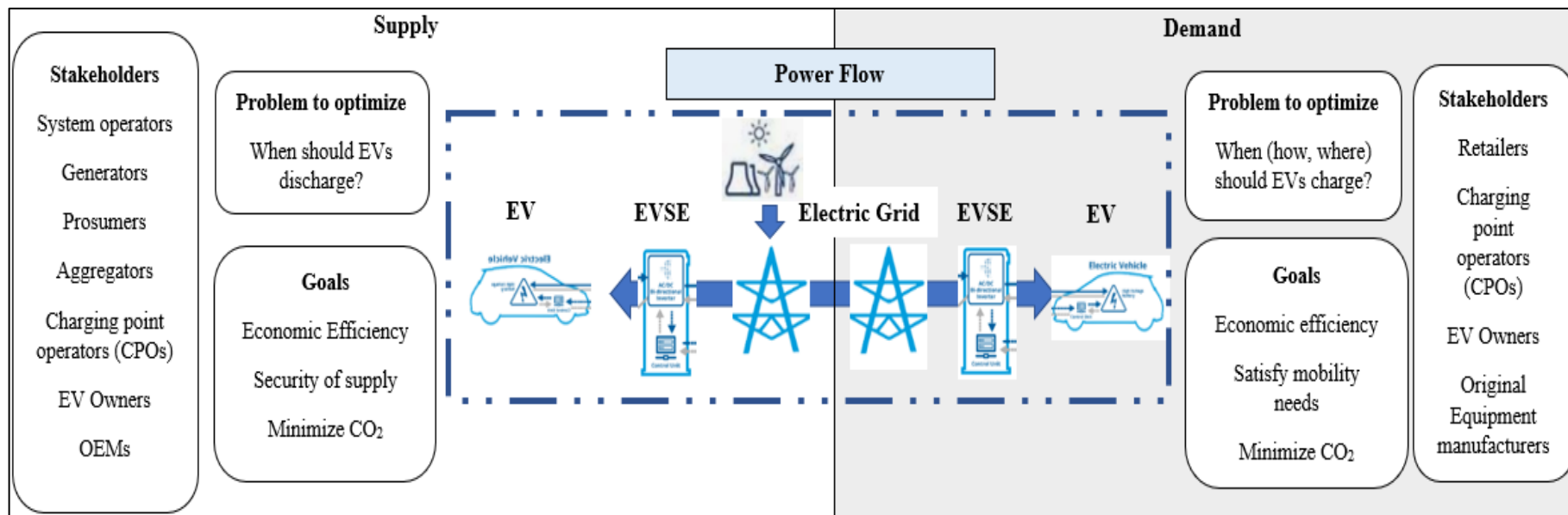

Furthermore, as Watson et al. (2010) suggest, an IS should tie together the three elements of an intelligent energy system – i.e., the power flow, the network of sensors, and sensitized objects, enabling stakeholders to exchange information. In Figure 4, we build a graphical representation of the interdependencies within the IS of V2G. It shows an interdependency between the information flow considered, which the stakeholders approve, and the outcome of the network flow optimization, affecting stakeholders' decisions to share information. This figure demonstrates many interdependent factors, making them seemingly impossible to solve. Thus, deciding what information is needed to include in the information flow and how to optimize the power network flow are interdependent choices. Even more, the optimization should provide value to all stakeholders involved. Otherwise, they might not participate in the information flow, making it even more challenging to address the complexity of environmental sustainability.

Figure 4

An example of how a Green IS ties together the components of an energy system. (Authors)

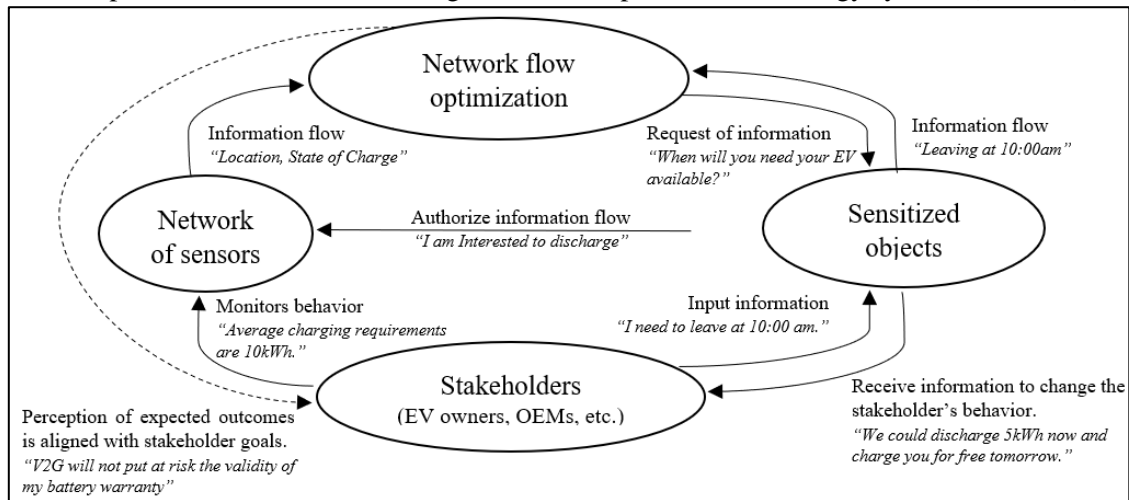

Given the several constraints imposed by the complexity of V2G, information gaps might severely limit its benefits. Indeed, V2G requires stakeholders to exchange information to internalize all the environmental and economic constraints in supply and demand. Therefore, Green IS design should be able to address this constraint. In the next section, we investigate the different alternatives the academic literature proposes to address this issue, focusing on its information flow.

4. Analyzing V2G information flow design

We are considering that Green IS design is an artifact (Simon, 1988) that, from an IS perspective, is a blueprint that defines the work, organization, and resources required to support the exchange and analysis of information for a specific purpose (Chen & Nunamaker, 1991; Hevner et al., 2004). We aim to analyze the information flow of V2G, identify how Green IS can close the information gaps, and manage the complexity of improving environmental sustainability while addressing the forces shaping the electric system. Therefore, in this section, we first present an analytical framework to build a standard definition of information flow that can be compared across different V2G designs. Then, we present the results from our analysis.

4.1. Analytical framework: Building a standard information flow

The analytical framework that we propose consists of four steps:

First, we focus on analyzing the V2G academic literature as, until now, it has been the primary source of rigor for V2G designers. Indeed, there is a scarcity of empirical knowledge or field

studies from large-scale commercial projects (V2G Data Hub, 2023). We aim to identify the V2G information flow on the articles published in the academic literature through systematic literature to have a representative sample of academic publications on V2G. We searched for article terms in two well-known scientific databases, Web of Science (WOS) and Scopus (Echchakoui, 2020). We considered only publications from academic articles published in index journals to guarantee consistency in the quality of the publications. We selected “Vehicle-to-Grid” and “Grid integrated vehicle.” as keywords of the search. Then, we used both databases’ options to export the metadata of the title, abstract, authors, and references from each article within the search.

Since our analysis requires us to read the articles thoroughly, we cluster them, and from each cluster, we select a sample of articles. To sample, we selected all the articles within the top 25 percentile from each cluster according to their relative share of citations and cluster centrality. To perform the clustering, we used a well-known algorithm typically used in systematic literature, bibliographic clustering² (Cobo et al., 2011; Kessler, 1963; Mas-Tur et al., 2021). Each cluster represents a sub-division of knowledge within V2G research.

However, because Scopus and WOS have different methodologies and consider different journals to calculate the citations of each publication, we could not join both databases and apply bibliographic coupling as if an article is in both databases, the algorithm will not be able to calculate their cluster, given that the article might have two different number of citations and weights in their link. To avoid this problem, we follow Echchakoui (2020) recommendations and only use one database, selecting the one that better fits our research’s scope and objectives according to the journals it considers.

Second, we standardize the definition of an information flow using a task-oriented approach. To do so, we identify within the academic publication how stakeholders interact to exchange information to optimize the V2G power flow. This approach identifies the stakeholders involved in V2G and their activities in the IS. We then use the stakeholder-task pairing to represent the information exchanges amongst actors as a network graph in which each node represents a stakeholder, and each link with its direction represents the IS’s information flow. The advantage of constructing the information flow using this approach is that it allows us to have a comparable artifact from which we can analyze the patterns of information flow design from several publications.

To build the network representation of the information flow, we used YEdGraph editor, an open-source software for network graph analysis. For each network, we apply a network analysis of weighted centrality using a “page rank” algorithm (Page et al., 1999). The network analysis helps quantify the position of each actor in the network based on the interdependencies of the information flow. The algorithm is already implemented in the open-source YEdGraph editor. The algorithm consists of two steps: First, it ranks the value for each node, assigning an initial default value. Then, it uses multiple iterations to propagate the rank of a node to its successors. The propagation of the rank is based on a matrix that defines how the page rank value will be propagated to the network nodes (Page, 1998). The matrix represents the system’s configuration by defining the number of outgoing and ingoing links for each node (Page, 1998). The iteration continues until the changes between iterations of the “page rank” value are below the specified precision or if the maximal number of iterations is reached (YWorks, 2021). The final page rank value is scaled by dividing the page ranks by the maximum value obtained by any actors who will get a page rank of 1 (YWorks, 2021).

² Bibliographic coupling is an algorithm that identifies clusters of publications with familiar references. It clusters articles based on comparing two indicators—the number of links, which defines the number of referenced publications two articles have in common, and—the total weight of links, which adds all the familiar references an article has within its links.

Finally, we compare the information flow to identify archetypes from patterns in the information flow. The archetypes should emerge from relevant dimensions of comparison and synthesize general rules or assumptions for V2G design. Archetypes should be mutually exclusive and explanatory but not overly prescriptive (Bocken et al., 2014). We use a decision tree as a classification algorithm to guarantee that the selection of dimensions is objective and reduce the classification's subjectivity.

4.2. Comparing the information flow of V2G

V2G has continuously attracted researchers' interest over the years. We found³ 2 667 publications in the Scopus search and 1 213 in WoS. Figure 5 shows the rapid increase of publications per year on the subject, evidence of its relevance.

Figure 5
Evolution of V2G publications.

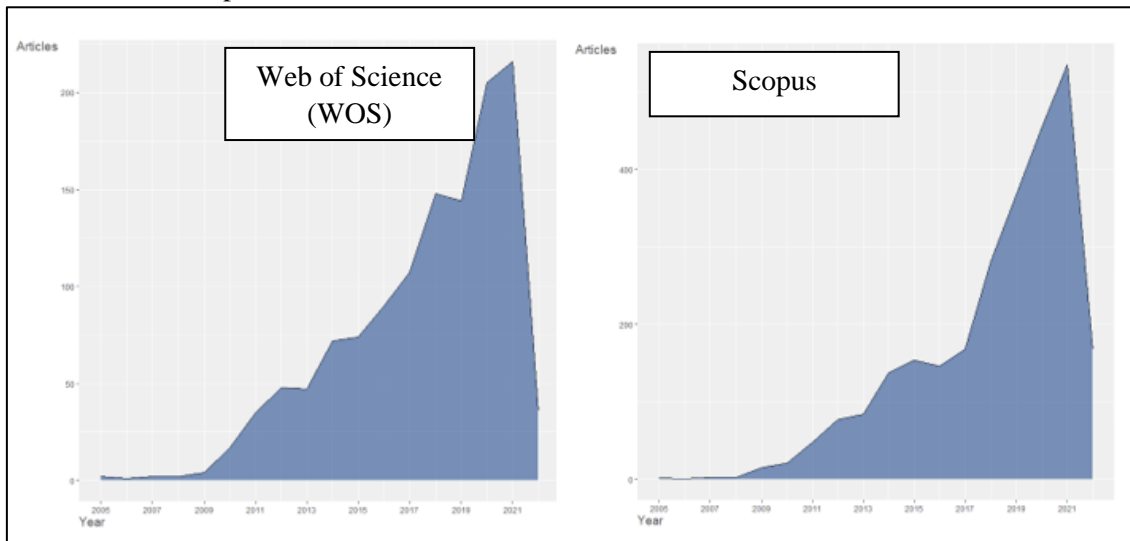

We selected WOS as the database to take our sample as the results better adjusted to our research question and sampling objectives. Figure 6 shows a co-occurrence analysis of the abstract and titles of the publications found in each database (Echchakoui, 2020). For Scopus, the analysis displays two main clusters of subjects: a red subject with common words such as gasoline, light vehicles, coal, and emission factor, and a blue group with terms such as car, electric power supply, and transport.

³ Search was performed on 25/03/2022.

Figure 6
Multi-criteria analysis (MCA) of text in the abstracts and titles from each publication.

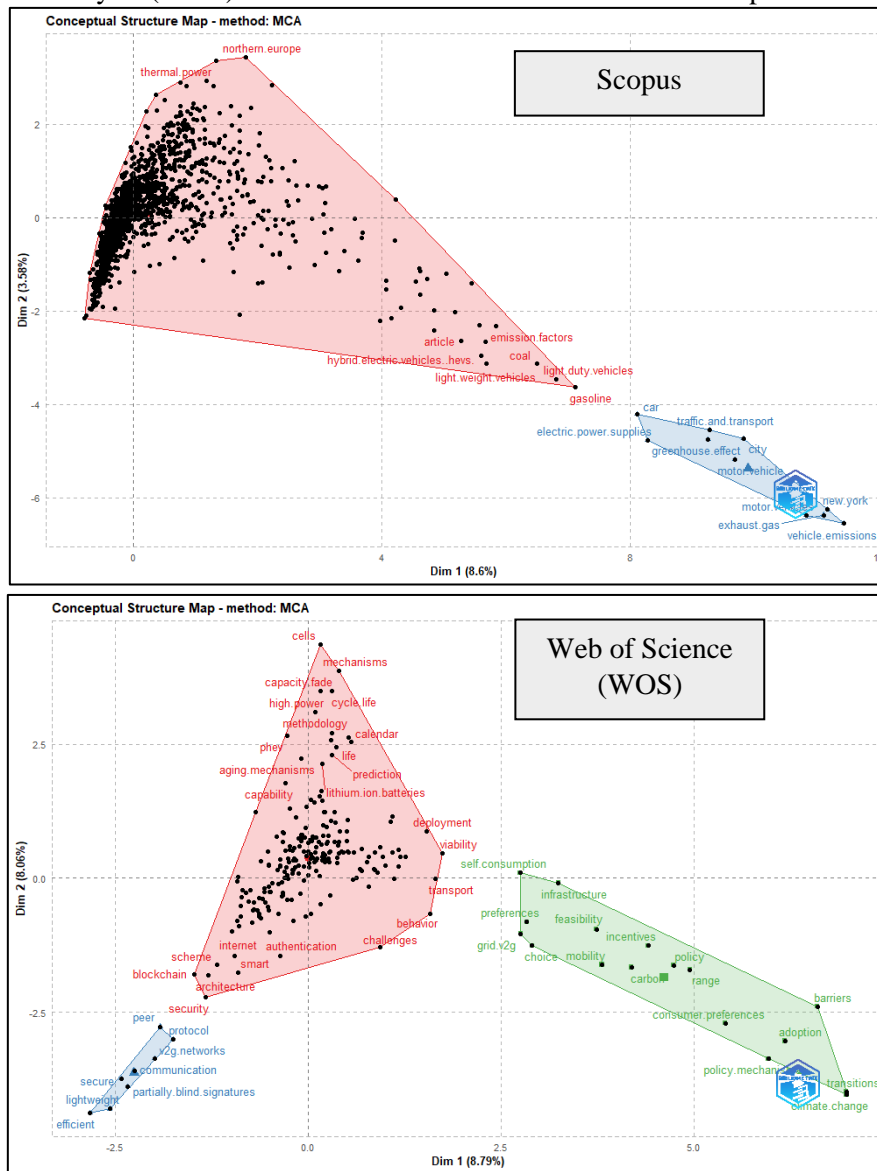

For WOS, the analysis displays three subjects: a blue subject with common words such as V2G networks and protocols, a green group with grid, V2G, and self-consumption, and a red subject with words such as architecture, transport, and capacity fade. The difference in the co-occurrence of words is because Scopus considers broader gray literature than WOS. Therefore, we selected WOS to focus the scope on rigorous academic journals, as the subjects seemed better defined and the subjects better target our research objective. Appendix A provides a detailed comparison of both databases' publications, journals, and leading authors.

We performed the bibliographic clustering analysis for the 1 213 WOS publications and selected the top 25 percentile of publications by relative citations and cluster centrality. Figure 7 shows the bibliographic clustering graphically; each color represents a cluster, and there are nine clusters in total; the cluster size represents the number of citations for each publication (below, we analyze the clusters according to their contribution to the integration of Green IS on energy systems). Appendix B details the selection process, showing the publications considered in each cluster and the selection process.

Figure 7
Clusters of V2G publications in WOS.

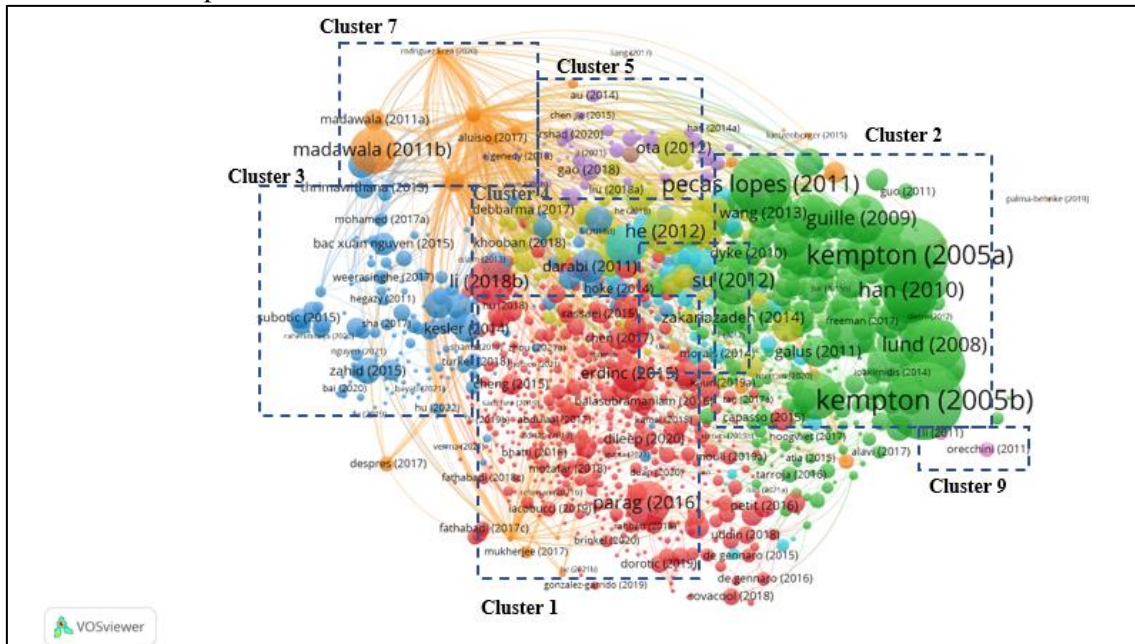

From the 1,273 publications, we selected 150 publications to analyze in detail, given that they were in the 25% top percentile of each cluster. The publications came from different types of journals, but engineering journals mostly dominated it. Each publication was read in detail to identify its information flow. However, in 97 of 150 publications, the underlying assumptions of how the components of the IS work together might be silent. Figure 8 shows the distribution of the top ten journals within the sample and the percentage of publications in which they conceptualize an information flow. Almost 70% of the publications analyzed have barely developed how the information is exchanged in their research.

Figure 8
Presence of information flow on publications by journals

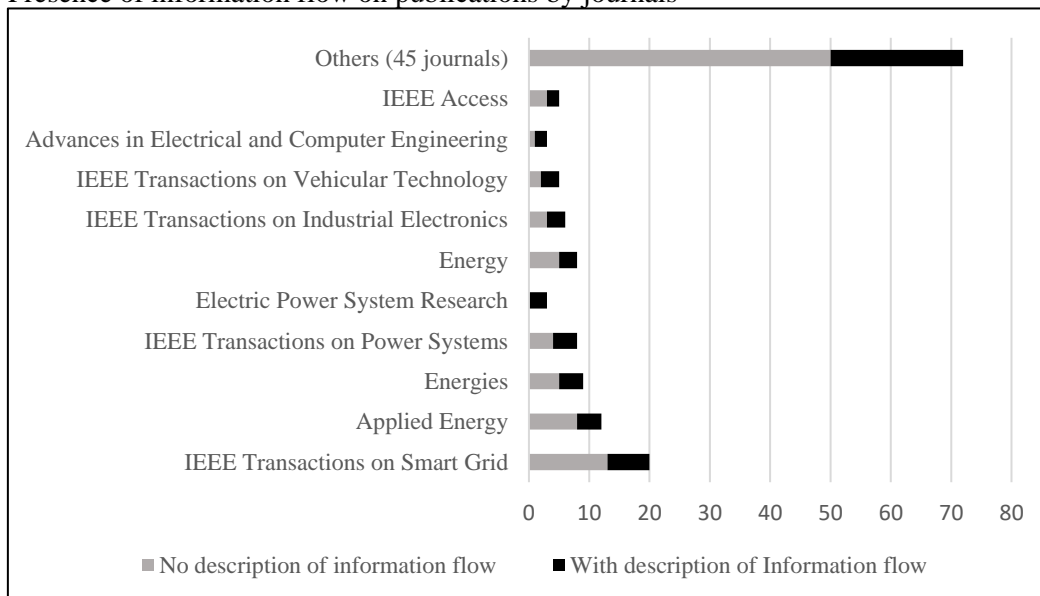

We systematized the actors-task relationships of the 53 publications to conceptualize the different information flow designs. Table 2 shows an example of the systematization resulting from one

publication. Appendix D shows all the details of the “actor-task” relationships used for each information flow.

Table 2

Example of Information flow, as an ‘Actor-task’ description. Publication: Chandra Mouli et al., (2019)

| Stake holder | Task | Articles citations - Design specification. |
|--------------|---|--|
| EV | A-1. Monitoring | <i>"The efficiency of the EV battery for charging and discharging is either obtained from the EV or stored in a database within the EMS for different EVs." (p.1316);</i> |
| EV user | A-2. Inputs preferences | <i>"The EV owners inform the EMS about their expected departure time T_{dv} and charging energy demand d_v." (p. 1316). "The users can enter the maximum and minimum charging and discharging power, respectively. By setting it to a non-zero value, the users can choose to participate in V2G services."</i> |
| EV user | A-3. Communicates, personal data, technical or economic constraints | <i>"The user links to the EMS, and the EMS instructs the user on which EV-PV charger he/she must connect to, based on two 'acceptance criteria'. 'The first criteria is that the energy demand and parking time, of all the EVs connected to one EV-PV charger, must be within the power limits of the charger. The second criteria is that the arrival SOC of the vehicle must be above the minimum SOC set by the user. "</i> |
| CPO | B-1. Provides communication infrastructure | <i>"The user links to the EMS, and the EMS instructs the user on which EV-PV charger he/she must connect to, based on two 'acceptance criteria'. 'The first criteria is that the energy demand and parking time, of all the EVs connected to one EV-PV charger, must be within the power limits of the charger. The second criteria is that the arrival SOC of the vehicle must be above the minimum SOC set by the user. "</i> |
| CPO | B-2. Software or digital application provider | <i>"The user links to the EMS, and the EMS instructs the user on which EV-PV charger he/she must connect to, based on two 'acceptance criteria'. 'The first criteria is that the energy demand and parking time, of all the EVs connected to one EV-PV charger, must be within the power limits of the charger. The second criteria is that the arrival SOC of the vehicle must be above the minimum SOC set by the user. "</i> |
| CPO | C-1. Aggregate data | <i>"Following the formulation in [15] and [16], an Energy Services Company (ESCO) company acts as an intermediary between the wholesale market operated by the Independent System Operator (ISO) and the EV end-users." (p. 1315)</i> |
| ISO | C-1. Aggregate data | <i>"Following the formulation in [15] and [16], an Energy Services Company (ESCO) company acts as an intermediary between the wholesale market operated by the Independent System Operator (ISO) and the EV end-users." (p. 1315)</i> |
| CPO | C-4. Forecast data | <i>"The EMS uses solar forecast information as an input to predict the PV variation." (p.1318)</i> |
| CPO | D-1. Optimize charging strategy | <i>"The ESCo operates at the workplace where employees drive to the office with an EV, and the building has overhead PV installation or a solar carport. The motive of the ESCo is to schedule the charging of the EV and feeding of PV power to the grid so that EV charging costs are lowered, regulation services are offered to the ISO, and at the same time, the income from PV is increased. "(p. 1315). "The ESCo is a price taker and does not influence the market clearing prices. It uses the settlement point prices for trading power in the market and reserve capacity prices for offering up and down-regulation services." (p.1317)</i> |
| CPO | E-1. Controls charge/discharge | <i>"The ESCo uses the EMS to control the solar-powered EV car park for energy trading with the grid" (Chandra Mouli et al., 2019, p. 1317)</i> |

Table 3 shows the different actors involved in the identified information flow. We can differentiate three brackets. First, a bracket between 60% and 50% of participation includes EV users, a third-party load aggregator, and the EV itself. The main difference that must be noted between an EV user and an EV is that an EV user implies that a human is participating in the information exchange. At the same time, an EV is the vehicle part of the information flow. In the case of the load aggregator, this is an actor whose sole purpose is to aggregate information; we will see in Table 4 that several actors might perform this role. The second bracket is between 40% and 30% of participation, in which we have the DSO and ISO, both system operators that have been considered primarily because of their role in the management of the electric grid. Finally, the third bracket shows a diversity of actors whose relative presence spread from 10% to 2%, and they are typically associated with an information flow that aims to describe a specific r V2G use case.

Table 3
Types of stakeholders identified in the information flow.

| Type | Actor | Relative frequency |
|--------------------------|--------------------------------------|--------------------|
| Mobility | EV user | 60% |
| Third-party | Load aggregator | 55% |
| Mobility | EV | 51% |
| System operator | DSO | 40% |
| System operator | ISO | 30% |
| Infrastructure operation | Parking operator | 9% |
| Infrastructure operation | Charging Point Operator (CPO) | 9% |
| Infrastructure operation | Public EVSE | 8% |
| Infrastructure operation | Home Energy Management System (HEMS) | 6% |
| Mobility | Fleet operator | 6% |
| System operator | MGO | 6% |
| System operator | TSO | 6% |
| Market operator | Wholesale market operator | 6% |
| Third-party | Digital application operator | 6% |
| Mobility | EV or fleet operators | 4% |
| Third-party | Certifier | 4% |
| Utilities | Generator | 4% |
| Retailer | Retailer | 2% |
| Third-party | Insurance provider | 2% |
| Third-party | Information provider | 2% |

Table 4 summarizes the complete list of tasks performed by the actors in the information flow organized according to their relative frequency. Our analysis shows that almost all information flows require at least three tasks: aggregate data, optimize the charging discharge strategy, and perform real-time charge control. These three tasks were present in more than 90% of the information flow analyzed. These tasks are followed by input preference, which requires the EV owner to communicate with the controller, sending them information about their itinerary to charge or discharge the EV. Furthermore, several tasks are related to optimizing the network operation or performing electricity and power trading operations. However, these are present in less than 60% of information flow.

Table 4
Tasks performed by stakeholders

| Type | Tasks | Relative frequency |
|------------------------------------|--|--------------------|
| Data management and transformation | C-1. Aggregates data. Combines and edits data from different sources. | 96% |
| Optimization | D-1. Optimize charging strategy—computation of the optimal charge/discharge schedule for the EV. | 92% |
| Power flow control | E-1. Control charge/discharge: Real-time control of the charge/discharge schedule implementation | 92% |
| Manage sensitized objects | A-2. Input preferences. EV owners' preferences affect the charge and discharge process in real-time. | 72% |
| Optimization | D-3. Optimize network operation: Manages and computes the optimal operation of the network infrastructure. | 57% |
| Manage sensitized objects | A-3. Communicates personal data and technical or economic constraints. | 49% |
| Optimization | D-4. Optimize electricity and power trading operations: Operates in the electric market and might be responsible for the contracts for electricity supply or computes bidding optimization. | 49% |
| Communication provider | B-1. Provides communication infrastructure: Provides the physical infrastructure of communication required for V2G. | 36% |
| Manage sensitized objects | A-1. Sensoring. The task of sensing physical parameters. | 28% |
| Communication provider | B-2. Software or digital application provider: Provide the digital layer and user experience design that allows users to interact with other actors. | 13% |
| Data management and transformation | C-2. Data validation. Validation of actors' identification. | 6% |
| Optimization | D-2. Optimize routing and navigation of EVs: Computes the optimal route and energy demand according to the EV user's needs. | 4% |
| Optimization | D-5. Optimize insurance for V2G: Reduces the risk for EV users and market operators when there is no information for a precise estimation of recharging prices, available energy, or power capacity. | 2% |

Figure 9 shows the 53 information flows identified in the publications as a network graph. Each node represents an actor, while each link exchanges information. The links are directed based on the description of each actor's tasks, as shown in the example from Table 4. For each information flow, we have two networks. The first network combines yellow and red. The red color defines the actor who performs the power flow control. The second network graph shows the network analysis. The darker the blue in a node, the higher the page rank (maximum value is 1), and the stakeholders in the information flow are more important.

Figure 9
V2G Information flow

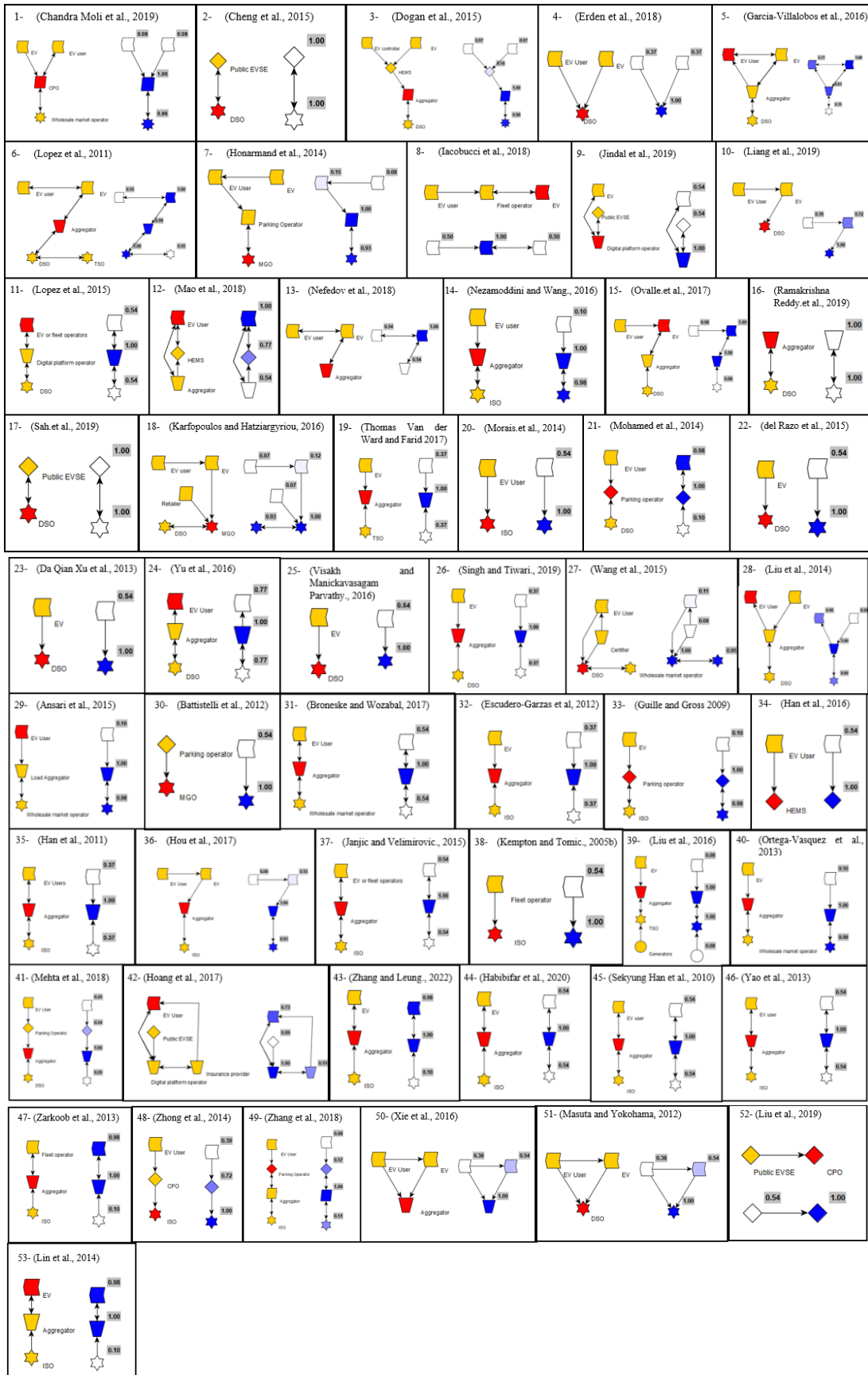

At first sight, it is visible from Figure 9 that they are significantly different in the design of the information flows conceived for V2G. Indeed, the design has different shapes; some information flows are linear, while others have a “Z” or a “Y” shape. Nevertheless, just from the shape of the information flow, we can say very little about how the design of the information flow might have implications for the energy informatics questions. Therefore, in Table 5, we have selected three dimensions of comparison rooted in the questions proposed by the research framework on energy informatics. The three questions are salient characteristics we can quickly identify from the information flow and are related to their design. Using the questions and analyzing the information flow, we identified design patterns on how the information flow has been designed in the academic literature.

Table 5
Dimensions of comparison for the information flow

| Watson et al. (2010) research questions | Design pattern of information flow |
|---|---|
| <p style="text-align: center;">IS</p> <p style="text-align: center;"><i>How can an information system integrate supply and demand data to increase energy efficiency?</i></p> | <p>According to the actor who controls the power flow, the information flow might be classified as follows:</p> <ul style="list-style-type: none"> • Centralized control: A centralized system is one in which one actor, different from the EV or EV user, is responsible for sending the signal of control. • Decentralized control: A decentralized system is one in which no central actor controls the EV; instead, the control is within the EV users or Fleet Operators to decide when the EV is charged or discharged. |
| <p style="text-align: center;">Flow Network</p> <p style="text-align: center;"><i>What information, and at what level of granularity, is required to optimize a given type of flow network?</i></p> | <p>According to the participation of mobility stakeholders in the information flow, this might be classified as:</p> <ul style="list-style-type: none"> • Requires information from mobility needs. Information is crucial in improving V2G reliability since EVs might have unexpected departures, as their primary use is for mobility. If an IS has mobility information, an actor within the mobility type category provides information. • Do not require information from mobility needs. |
| <p style="text-align: center;">Sensitized objects.</p> <p style="text-align: center;"><i>What information do consumers need about using their own or managing objects to increase energy efficiency?</i></p> | <p>According to the channel that EV owners or users have to communicate with the controller, the information flow might be classified as follows:</p> <ul style="list-style-type: none"> • EV or EVSE as the main interphase: An indirect relationship through the subscription of their EVs or EVSE. The object directly communicates with the central actor or controller indirectly. • EV owner or EV user as primary reference: The EV user directly relates to the power network controller, communicating directly from their cell phone. |

With the dimension of Table 5, we built a decision tree that we display in Figure 10. Each decision node provides a hierarchical dimension to classify the information flows, and each terminal node is an exclusive archetype. The decision tree allows us to classify each of the fifty-three information flows into only one design archetype, allowing for traceability in the classification. Appendix E shows the final classification of each information flow into an archetype.

Figure 10

Decision tree to classify the information flow into archetypes according to their design patterns

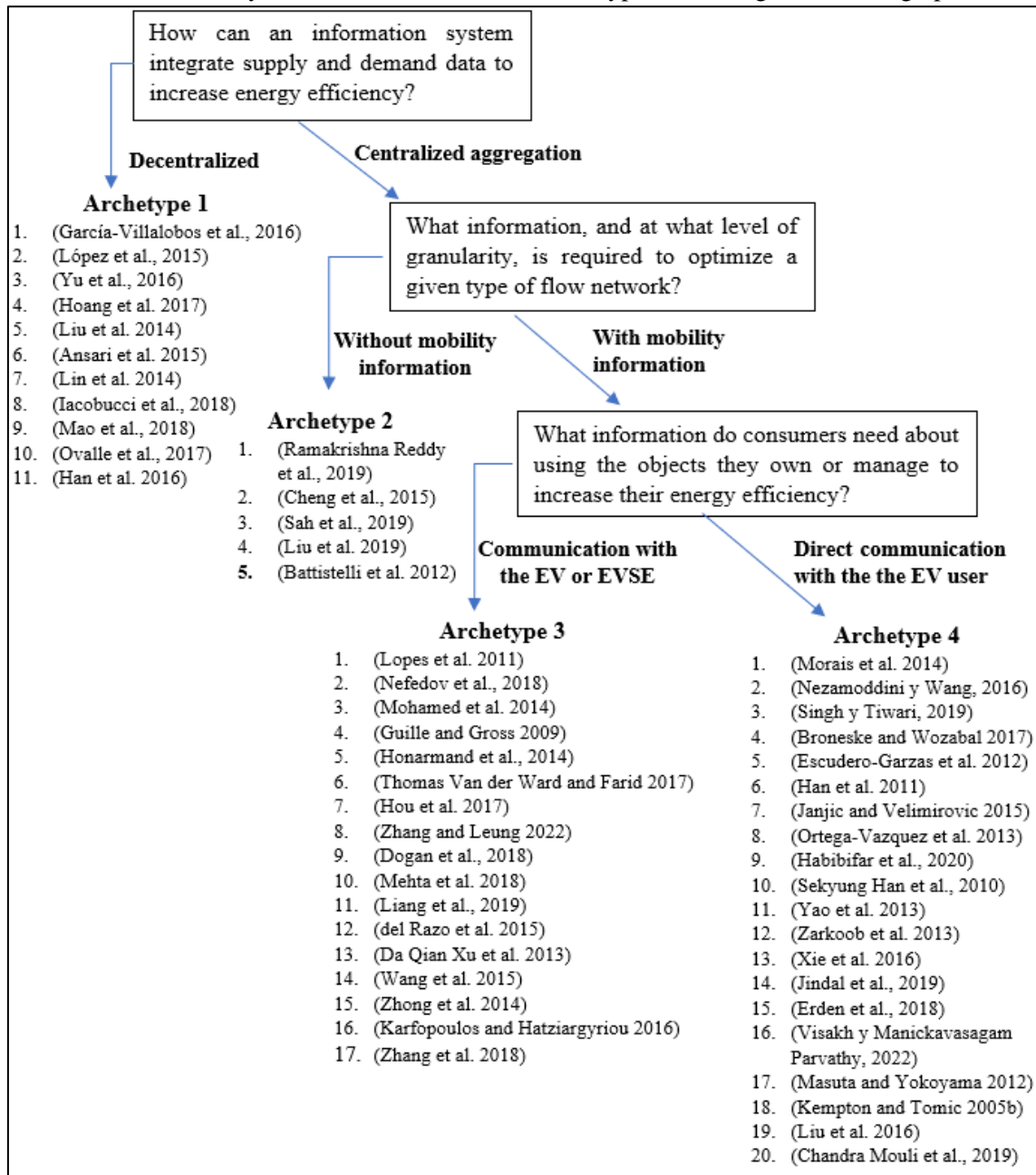

Furthermore, after classifying the information flow into archetypes, we summarize the main characteristics according to how the design rules presented in Table 7 address the complexity from two perspectives: First, it defines how an IS enables to aggregate information, and second, what information is it required to be aggregated. This synthesizes what we define as design rules that academic publications have applied to design the information flow of V2G.

Table 6

Design rules for V2G information flow

| Archetype | Aggregate information | Information required to be aggregated |
|---|--|--|
| Archetype 1 Decentralized systems | Instead of a central controller to decide the charge or discharge of the EV. Each mobility | The price signal needs to anticipate the expected behavior of the agents |

| Archetype | Aggregate information | Information required to be aggregated |
|--|--|---|
| | <p>user (fleet operator or EV user) controls the charge /discharge responding to a price signal.</p> <p>EV users must be able to analyze the cost-benefit of changing their charge/discharge patterns.</p> | and adapt to the changes in renewable energy production. |
| Archetype 2 Grid management system | <p>A central controller decides the charge/discharge of the EV. The main objective of the information flow is to manage the electric system operation within optimal operation ranges.</p> <p>Grid operators or CPOs control the charge and discharge without communicating with the EV user and controlling the EVs through the EVSE.</p> | <p>Requires controllers to estimate the arrival and departure time of the EV based on the information exchanges between the EV and EVSE.</p> <p>Requires controllers to estimate the SOC of the EVs and the minimum SOC required for the next trip.</p> |
| Archetype 3 Object-oriented system | <p>A central controller decides the charge/discharge of the EV. In its decision, it considers information from mobility needs.</p> <p>The information from the mobility needs is directly received from an object such as an EVSE or a particular EV. Such a system requires at least two communication interphase.</p> <ol style="list-style-type: none"> i. Between the controller and the EVSE, or the EV. ii. From the EVSE or EV towards the EV user or fleet operator. | <p>Requires to estimate the EV user mobility needs based on the monitoring of the object.</p> <p>Requires the controller to have information about the battery degradation.</p> <p>Requires the electric grid requirements and renewable energy production.</p> |
| Archetype 4 User-oriented system | <p>A central controller decides the charge/discharge of the EV.</p> <p>There is only one communication interphase for exchanging information between the controller and the EV user. EV users directly send information about their mobility needs.</p> | <p>The controller must have information on electric grid requirements and renewable energy production.</p> <p>The EV user must be able to communicate the information from the EV location and the characteristics of the EVSE.</p> |

5. Discussions

The main objective of energy informatics is to provide research guidance on how to design Green IS that effectively improves the environmental sustainability of energy systems. Within this context, we argue that electricity systems require special considerations in the design of these Green IS. Therefore, we analyze V2G from an IS perspective to unveil the design of their information flow.

In particular, the task-actor relationship from the information flow allows us to identify the most relevant actors and tasks required to implement V2G. Notably, the need for an intermediary to aggregate the data and the dual role of EV owners and EVs as both consumers and suppliers is what we will define with the term prosumers. However, neither of these actors can easily be classified within the three types of stakeholders defined by Watson et al. (2010). Indeed, for Watson et al. (2010), a stakeholder might be either a government, a consumer, or a supplier, but not a combination at the same time.

In consequence of the above, we propose to amend the research framework proposed by Watson et al. (2010) for energy informatics and define specific questions for electric systems, considering information aggregators and prosumers as stakeholders.

For aggregators, the questions arising from their role in the electric system are related to how it might challenge the forces that have shaped the electric system to have a monopolist system operator perform the tasks to balance the grid. Indeed, it might be the case that the increased granularity and access to information from aggregators, specialized in managing the information from different types of technologies, might challenge the assumption that a system operator is required and instead enable a decentralized electric grid operation. For example, Schweppe et al. (1980) propose a theoretical organization of electric systems that a homeostatic utility control can offer advantages to achieve stability and minimize costs. In a homeostatic control, the electric grid functions in homeostasis (a biological term referring to a system equilibrium) through the integration of frequency-responsive switches, short-term markets, and ICT that can enable any consumer or producer to change their supply or demand without requiring the approval of a system operator or incurring on the administrative costs of participating on regulated markets, therefore maximizing the availability of energy resources (Schweppe et al., 1980).

In economics, hierarchical relations, such as those currently existing in the operation of electric networks and markets, are explained whenever they are market frictions and, therefore, require non-market organizations (Williamson, 1973). Some of these frictions in electric systems are related to information problems, most notably the capacity that market mechanisms cannot respond fast enough to achieve the network’s physical operating parameters, thus requiring a central operator (Joskow & Tirole, 2007). Therefore, we think that a question worth considering in future research on the design of Green IS for electric systems is: *How can decentralized information aggregation support the network’s physical balance of the grid and increase the electric system’s environmental sustainability?*

For prosumers, the question proposed by Watson et al. (2010) linking Sensitized Objects with consumers is highly relevant, i.e., What information do consumers need about using the objects they own or manage to increase their energy efficiency? However, the fact that prosumers can also supply energy imposes additional requirements on the sensitized objects from which they will interact with other actors on the electric grid. Indeed, they need information to change their consumption, and therefore, Watson et al. (2010) question is relevant. However, they must also provide information to signal their willingness to supply energy and at which cost. Therefore, we think that a question worth considering in future research on the design of Green IS for electric systems is: *What information do prosumers need to share about the usage of the DERs they own signaling their willingness and availability to supply energy?*

In Table 7, we have structured the two research questions we propose in a matrix that can be easily integrated into the energy informatics research question.

Table 7
Additional research question for electric systems

| Stakeholders | Energy system components | | | Information Systems |
|--------------|--------------------------|--------------|--------------------|---|
| | Sensor Network | Flow Network | Sensitized Objects | |
| Aggregators | | | | How can decentralized information aggregation support the network’s physical balance of the grid and increase the electric system’s environmental sustainability? |

| Stakeholders | Energy system components | | | Information Systems |
|--------------|--------------------------|--------------|---|---------------------|
| | Sensor Network | Flow Network | Sensitized Objects | |
| Prosumers | | | What information do prosumers need to share about using their DERs to signal their willingness and availability to supply energy? | |

Furthermore, our analysis shows that despite V2G requiring a complex information flow to improve the environmental sustainability of electric systems, we found that 70% of the analyzed publications do not address the design of an information flow. Indeed, we found from our analysis that most of the research in V2G has focused on the development of algorithms, and several of them ignore that an IS is required to feed the algorithms with data. Therefore, we think there is still a need to develop research on Green IS and its integration with energy systems to develop research that might be used for researchers in other disciplines, such as engineering and economics. We think that the design rules we derive from the analysis of V2G are a type of contribution that IS researchers could develop in future research to support the design of better Green IS.

6. Conclusions

In order to make our energy systems greener, information systems can play an essential enabling role. In an emerging field of IS literature, Watson has identified the specific questions that should be answered for green IS to be effective. In particular, he looked at these questions from the perspective of three critical actors: energy suppliers, consumers, and governments.

However, the field of green IS has ignored the specific nature of electricity systems and the impact this may have on the necessary information flows. Unlike most energy systems, the energy is derived from consuming a fluid; electricity systems have physical constraints that focus on suppliers, consumers, and governments, limiting their systems design. The nature of the electricity system is defined by the interdependencies between supply and demand, making their nature more complex than other energy systems.

In order to integrate these complexities in green electricity information systems design and have a more comprehensive set of design criteria for green electricity IS design, we use a design science research lens as an analytical framework, which we apply to a specific field of green electricity systems, namely Vehicle-to-Grid. Vehicle to Grid is a system whereby battery EVs are used as an energy sink for the electricity system, able to both consume and produce power for the grid.

Our analysis of V2G shows that for green electricity IS to be designed, two sets of actors need to be added to the ones considered in Watson's framework: prosumers and aggregators. It is impossible to design green V2G systems without specifically integrating these types of actors.

By analyzing the current V2G literature, we also find that the current literature has not paid attention to the information flows necessary to optimize green V2G systems from the perspective of prosumers and aggregators. From this analysis, we can derive avenues for future research in Green electricity systems, and therefore, Green IS, but also new design criteria for making V2G systems possible.

Acknowledgments

We thank Guilherme Alcantara, the Working Group Decentralized Electricity and Mobility at Université Paris Dauphine, Guy Fournier, Camille Megy, Claire Lu, Orestes Fersov, Felipe Gonzalez, and Julie Bulteaux for comments on previous versions of this document.

References

- Andreotti, A., Carpinelli, G., Mottola, F., Proto, D., 2012. A review of single-objective optimization models for plug-in vehicles operation in smart grids part I: Theoretical aspects, in: 2012 IEEE Power and Energy Society General Meeting. Presented at the 2012 IEEE Power & Energy Society General Meeting. New Energy Horizons - Opportunities and Challenges, IEEE, San Diego, CA, pp. 1–8. <https://doi.org/10.1109/PESGM.2012.6345381>
- Ansari, M., Al-Awami, A.T., Sortomme, E., Abido, M.A., 2015. Coordinated bidding of ancillary services for vehicle-to-grid using fuzzy optimization. *IEEE Trans. Smart Grid* 6, 261–270. <https://doi.org/10.1109/TSG.2014.2341625>
- Battistelli, C., Baringo, L., Conejo, A.J., 2012. Optimal energy management of small electric energy systems including V2G facilities and renewable energy sources. *Electric Power Systems Research* 92, 50–59. <https://doi.org/10.1016/j.epsr.2012.06.002>
- Borne, O., Korte, K., Perez, Y., Petit, M., Purkus, A., 2018. Barriers to entry in frequency-regulation services markets: Review of the status quo and options for improvements. *Renewable and Sustainable Energy Reviews* 81, 605–614. <https://doi.org/10.1016/j.rser.2017.08.052>
- Broneske, G., Wozabal, D., 2017. How Do Contract Parameters Influence the Economics of Vehicle-to-Grid? *M&SOM* 19, 150–164. <https://doi.org/10.1287/msom.2016.0601>
- Chandra Mouli, G.R., Kefayati, M., Baldick, R., Bauer, P., 2019. Integrated PV Charging of EV Fleet Based on Energy Prices, V2G, and Offer of Reserves. *IEEE Trans. Smart Grid* 10, 1313–1325. <https://doi.org/10.1109/TSG.2017.2763683>
- Chen, M., Nunamaker, J.F., 1991. The architecture and design of a collaborative environment for systems definition. *SIGMIS Database* 22, 22–29. <https://doi.org/10.1145/110790.110795>
- Cheng, L., Chang, Y., Huang, R., 2015. Mitigating Voltage Problem in Distribution System With Distributed Solar Generation Using Electric Vehicles. *IEEE Trans. Sustain. Energy* 6, 1475–1484. <https://doi.org/10.1109/TSTE.2015.2444390>
- Cobo, M.J., López-Herrera, A.G., Herrera-Viedma, E., Herrera, F., 2011. Science mapping software tools: Review, analysis, and cooperative study among tools. *J. Am. Soc. Inf. Sci.* 62, 1382–1402. <https://doi.org/10.1002/asi.21525>
- Da Qian Xu, Joos, G., Levesque, M., Maier, M., 2013. Integrated V2G, G2V, and Renewable Energy Sources Coordination Over a Converged Fiber-Wireless Broadband Access Network. *IEEE Trans. Smart Grid* 4, 1381–1390. <https://doi.org/10.1109/TSG.2013.2253337>
- Dedrick, J., 2010. Green IS: Concepts and Issues for Information Systems Research. *CAIS* 27. <https://doi.org/10.17705/1CAIS.02711>
- Del Razo, V., Goebel, C., Jacobsen, H.-A., 2015. Vehicle-Originating-Signals for Real-Time Charging Control of Electric Vehicle Fleets. *IEEE Transactions on Transportation Electrification* 1, 150–167. <https://doi.org/10.1109/TTE.2015.2445215>

- Dogan, A., Bahceci, S., Daldaban, F., Alci, M., 2018. Optimization of Charge/Discharge Coordination to Satisfy Network Requirements Using Heuristic Algorithms in Vehicle-to-Grid Concept. *Adv. Electr. Comp. Eng.* 18, 121–130. <https://doi.org/10.4316/AECE.2018.01015>
- Echchakoui, S., 2020. Why and how to merge Scopus and Web of Science during bibliometric analysis: the case of sales force literature from 1912 to 2019. *J Market Anal* 8, 165–184. <https://doi.org/10.1057/s41270-020-00081-9>
- Erden, F., Kisacikoglu, M.C., Erdogan, N., 2018. Adaptive V2G Peak Shaving and Smart Charging Control for Grid Integration of PEVs. *Electric Power Components and Systems* 46, 1494–1508. <https://doi.org/10.1080/15325008.2018.1489435>
- Escudero-Garzas, J.J., Garcia-Armada, A., Seco-Granados, G., 2012. Fair Design of Plug-in Electric Vehicles Aggregator for V2G Regulation. *IEEE Trans. Veh. Technol.* 61, 3406–3419. <https://doi.org/10.1109/TVT.2012.2212218>
- García-Villalobos, J., Zamora, I., Knezović, K., Marinelli, M., 2016. Multi-objective optimization control of plug-in electric vehicles in low voltage distribution networks. *Applied Energy* 180, 155–168. <https://doi.org/10.1016/j.apenergy.2016.07.110>
- Gholami, R., Watson, R., University of Georgia, Hasan, H., University of Wollongong, Molla, A., RMIT University, Bjorn-Andersen, N., Copenhagen Business School, 2016. Information Systems Solutions for Environmental Sustainability: How Can We Do More? *JAIS* 17, 521–536. <https://doi.org/10.17705/1jais.00435>
- Gschwendtner, C., Sinsel, S.R., Stephan, A., 2021. Vehicle-to-X (V2X) implementation: An overview of predominate trial configurations and technical, social and regulatory challenges. *Renewable and Sustainable Energy Reviews* 145, 110977. <https://doi.org/10.1016/j.rser.2021.110977>
- Guille, C., Gross, G., 2009. A conceptual framework for the vehicle-to-grid (V2G) implementation. *Energy Policy* 37, 4379–4390. <https://doi.org/10.1016/j.enpol.2009.05.053>
- Habibifar, R., Aris Lekvan, A., Ehsan, M., 2020. A risk-constrained decision support tool for EV aggregators participating in energy and frequency regulation markets. *Electric Power Systems Research* 185, 106367. <https://doi.org/10.1016/j.epsr.2020.106367>
- Han, S., Han, S., Sezaki, K., 2010. Development of an optimal vehicle-to-grid aggregator for frequency regulation. *IEEE Transactions on Smart Grid* 1, 65–72. <https://doi.org/10.1109/TSG.2010.2045163>
- Han, Sekyung, Aki, H., Han, Soohee, Kwon, B., Park, J.-B., 2016. Optimal charging strategy for a residential PEV battery considering bidirectional trade and frequency regulation. *Int. J. Control Autom. Syst.* 14, 587–597. <https://doi.org/10.1007/s12555-014-0303-1>
- Han, Sekyung, Han, Soohee, Sezaki, K., 2011. Estimation of Achievable Power Capacity From Plug-in Electric Vehicles for V2G Frequency Regulation: Case Studies for Market Participation. *IEEE Trans. Smart Grid* 2, 632–641. <https://doi.org/10.1109/TSG.2011.2160299>
- Hevner, A.R., 2007. A Three Cycle View of Design Science Research 19.
- Hevner, A.R., March, S.T., Park, J., Ram, S., 2004. Design Science in Information Systems Research. *MIS Quarterly*.

- Hoang, D.T., Wang, P., Niyato, D., Hossain, E., 2017. Charging and Discharging of Plug-In Electric Vehicles (PEVs) in Vehicle-to-Grid (V2G) Systems: A Cyber Insurance-Based Model. *IEEE Access*.
- Honarmand, M., Zakariazadeh, A., Jadid, S., 2014. Integrated scheduling of renewable generation and electric vehicles parking lot in a smart microgrid. *Energy Conversion and Management* 86, 745–755.
<https://doi.org/10.1016/j.enconman.2014.06.044>
- Hou, M., Zhao, Y., Ge, X., 2017. Optimal scheduling of the plug-in electric vehicles aggregator energy and regulation services based on grid to vehicle. *International Trans Energ Syst*.
- Iacobucci, R., McLellan, B., Tezuka, T., 2018. Modeling shared autonomous electric vehicles: Potential for transport and power grid integration. *Energy* 158, 148–163. <https://doi.org/10.1016/j.energy.2018.06.024>
- Janjic, A., Velimirovic, L.Z., 2015. Optimal Scheduling of Utility Electric Vehicle Fleet Offering Ancillary Services. *ETRI J* 37, 273–282.
<https://doi.org/10.4218/etrij.15.2314.0046>
- Jindal, A., Aujla, G.S., Kumar, N., 2019. SURVIVOR: A blockchain based edge-as-a-service framework for secure energy trading in SDN-enabled vehicle-to-grid environment. *Computer Networks* 153, 36–48.
<https://doi.org/10.1016/j.comnet.2019.02.002>
- Joskow, P., Tirole, J., 2007. Reliability and Competitive Electricity Markets. *RAND Journal of Economics*.
- Joskow, P.L., 2008. Lessons Learned from Electricity Market Liberalization. *EJ* 29.
<https://doi.org/10.5547/ISSN0195-6574-EJ-Vol29-NoSI2-3>
- Karfopoulos, E.L., Hatziargyriou, N.D., 2016. Distributed Coordination of Electric Vehicles Providing V2G Services. *IEEE Trans. Power Syst.* 31, 329–338.
<https://doi.org/10.1109/TPWRS.2015.2395723>
- Kempton, W., Tomić, J., 2005. Vehicle-to-grid power implementation: From stabilizing the grid to supporting large-scale renewable energy. *Journal of Power Sources* 144, 280–294. <https://doi.org/10.1016/j.jpowsour.2004.12.022>
- Kessler, M.M., 1963. Bibliographic coupling between scientific papers. *Amer. Doc.* 14, 10–25. <https://doi.org/10.1002/asi.5090140103>
- Ketter, W., Collins, J., Saar-Tsechansky, M., Marom, O., 2018. Information Systems for a Smart Electricity Grid: Emerging Challenges and Opportunities. *ACM Trans. Manage. Inf. Syst.* 9, 1–22. <https://doi.org/10.1145/3230712>
- Ketter, W., Schroer, K., Valogianni, K., 2022. Information Systems Research for Smart Sustainable Mobility: A Framework and Call for Action. *Information Systems Research isre.2022.1167*. <https://doi.org/10.1287/isre.2022.1167>
- Liang, H., Liu, Y., Li, F., Shen, Y., 2019. Dynamic Economic/Emission Dispatch Including PEVs for Peak Shaving and Valley Filling. *IEEE Trans. Ind. Electron.* 66, 2880–2890. <https://doi.org/10.1109/TIE.2018.2850030>
- Lin, J., Leung, K.-C., Li, V.O.K., 2014. Optimal Scheduling With Vehicle-to-Grid Regulation Service. *IEEE Internet Things J.* 1, 556–569.
<https://doi.org/10.1109/IIOT.2014.2361911>
- Liu, D., Wang, Y., Shen, Y., 2016. Electric Vehicle Charging and Discharging Coordination on Distribution Network Using Multi-Objective Particle Swarm Optimization and Fuzzy Decision Making. *Energies* 9, 186.
<https://doi.org/10.3390/en9030186>

- Liu, H., Huang, K., Wang, N., Qi, J., Wu, Q., Ma, S., Li, C., 2019. Optimal dispatch for participation of electric vehicles in frequency regulation based on area control error and area regulation requirement. *Applied Energy* 240, 46–55. <https://doi.org/10.1016/j.apenergy.2019.02.044>
- Liu, H., Ning, H., Zhang, Y., Xiong, Q., Yang, L.T., 2014. Role-Dependent Privacy Preservation for Secure V2G Networks in the Smart Grid. *IEEE Trans. Inform. Forensic Secur.* 9, 208–220. <https://doi.org/10.1109/TIFS.2013.2295032>
- Lopes, J.A.P., Soares, F.J., Almeida, P.M.R., 2011. Integration of electric vehicles in the electric power system. *Proceedings of the IEEE* 99, 168–183. <https://doi.org/10.1109/JPROC.2010.2066250>
- López, M.A., de la Torre, S., Martín, S., Aguado, J.A., 2015. Demand-side management in smart grid operation considering electric vehicles load shifting and vehicle-to-grid support. *International Journal of Electrical Power & Energy Systems* 64, 689–698. <https://doi.org/10.1016/j.ijepes.2014.07.065>
- Lund, H., Kempton, W., 2008. Integration of renewable energy into the transport and electricity sectors through V2G. *ENERGY POLICY*. <https://doi.org/10.1016/j.enpol.2008.06.007>
- Malhotra, A., Hill, C., 2013. Spurring Impactful Research on Information Systems for Environmental Sustainability. *MIS Quarterly*.
- Mao, T., Lau, W., Shum, C., Chung, H.S.-H., Tsang, K.-F., Tse, N.C.-F., 2018. A Regulation Policy of EV Discharging Price for Demand Scheduling. *IEEE Trans. Power Syst.* 33, 1275–1288. <https://doi.org/10.1109/TPWRS.2017.2727323>
- Mas-Tur, A., Roig-Tierno, N., Sarin, S., Haon, C., Segó, T., Belkhouja, M., Porter, A., Merigó, J.M., 2021. Co-citation, bibliographic coupling and leading authors, institutions and countries in the 50 years of Technological Forecasting and Social Change. *Technological Forecasting and Social Change* 165, 120487. <https://doi.org/10.1016/j.techfore.2020.120487>
- Masuta, T., Yokoyama, A., 2012. Supplementary Load Frequency Control by Use of a Number of Both Electric Vehicles and Heat Pump Water Heaters. *IEEE Trans. Smart Grid* 3, 1253–1262. <https://doi.org/10.1109/TSG.2012.2194746>
- Mehta, R., Srinivasan, D., Khambadkone, A.M., Yang, J., Trivedi, A., 2018. Smart Charging Strategies for Optimal Integration of Plug-In Electric Vehicles Within Existing Distribution System Infrastructure. *IEEE Trans. Smart Grid* 9, 299–312. <https://doi.org/10.1109/TSG.2016.2550559>
- Meyer, M.K., 1931. S'upplement to "Nature," August 29, 193.
- Mohamed, A., Salehi, V., Ma, T., Mohammed, O., 2014. Real-Time Energy Management Algorithm for Plug-In Hybrid Electric Vehicle Charging Parks Involving Sustainable Energy. *IEEE Trans. Sustain. Energy* 5, 577–586. <https://doi.org/10.1109/TSTE.2013.2278544>
- Morais, H., Sousa, T., Vale, Z., Faria, P., 2014. Evaluation of the electric vehicle impact in the power demand curve in a smart grid environment. *Energy Conversion and Management* 82, 268–282. <https://doi.org/10.1016/j.enconman.2014.03.032>
- Nefedov, E., Sierla, S., Vyatkin, V., 2018. Internet of Energy Approach for Sustainable Use of Electric Vehicles as Energy Storage of Prosumer Buildings. *Energies* 11, 2165. <https://doi.org/10.3390/en11082165>

- Newbery, D., Pollitt, M.G., Ritz, R.A., Strielkowski, W., 2018. Market design for a high-renewables European electricity system. *Renewable and Sustainable Energy Reviews* 91, 695–707. <https://doi.org/10.1016/j.rser.2018.04.025>
- Nezamoddini, N., Wang, Y., 2016. Risk management and participation planning of electric vehicles in smart grids for demand response. *Energy* 116, 836–850. <https://doi.org/10.1016/j.energy.2016.10.002>
- Ortega-Vazquez, M.A., Bouffard, F., Silva, V., 2013. Electric Vehicle Aggregator/System Operator Coordination for Charging Scheduling and Services Procurement. *IEEE Trans. Power Syst.* 28, 1806–1815. <https://doi.org/10.1109/TPWRS.2012.2221750>
- Ovalle, A., Hably, A., Bacha, S., Ramos, G., Hossain, J.M., 2017. Escort Evolutionary Game Dynamics Approach for Integral Load Management of Electric Vehicle Fleets. *IEEE Trans. Ind. Electron.* 64, 1358–1369. <https://doi.org/10.1109/TIE.2016.2615042>
- Page, L., Brin, S., Motwani, R., Winograd, T., 1999. The PageRank Citation Ranking: Bringing Order to the Web. Stanford Info Lab, Technical Report.
- Parag, Y., Sovacool, B.K., 2016. Electricity market design for the prosumer era. *Nat Energy* 1, 16032. <https://doi.org/10.1038/nenergy.2016.32>
- Ramakrishna Reddy, K., Meikandasivam, S., Vijayakumar, D., 2019. A novel strategy for maximization of plug-In electric vehicle's storage utilization for grid support with consideration of customer flexibility. *Electric Power Systems Research* 170, 158–175. <https://doi.org/10.1016/j.epsr.2018.12.031>
- Sah, B., Kumar, P., Rayudu, R., Bose, S.K., Inala, K.P., 2019. Impact of Sampling in the Operation of Vehicle to Grid and Its Mitigation. *IEEE Trans. Ind. Inf.* 15, 3923–3933. <https://doi.org/10.1109/TII.2018.2886633>
- Schwepe, F., Tabors, R., Kirtley, J., Outhred, H., Pickel, F., Cox, A., 1980. Homeostatic Utility Control. *IEEE Trans. on Power Apparatus and Syst.* PAS-99, 1151–1163. <https://doi.org/10.1109/TPAS.1980.319745>
- Simon, H.A., 1988. *The science of design: Creating the Artificial*, Design Issues.
- Singh, J., Tiwari, R., 2019. Real power loss minimisation of smart grid with electric vehicles using distribution feeder reconfiguration. *IET Generation, Transmission & Distribution* 13, 4249–4261. <https://doi.org/10.1049/iet-gtd.2018.6330>
- Smythe, W.R., 1988. *Static and Dynamic Electricity*, McGraw-Hill Book Company. Ed.
- Sorokin, A., Rebennack, S., Pardalos, P.M., Iliadis, N.A., Pereira, M.V.F. (Eds.), 2012. *Handbook of Networks in Power Systems I, Energy Systems*. Springer Berlin Heidelberg, Berlin, Heidelberg. <https://doi.org/10.1007/978-3-642-23193-3>
- Sovacool, B.K., Kester, J., Noel, L., Zarazua de Rubens, G., 2020. Actors, business models, and innovation activity systems for vehicle-to-grid (V2G) technology: A comprehensive review. *Renewable and Sustainable Energy Reviews* 131, 109963. <https://doi.org/10.1016/j.rser.2020.109963>
- Thomas Van der Wardt, Farid, A., 2017. A Hybrid Dynamic System Assessment Methodology for Multi-Modal Transportation-Electrification. *Energies* 10, 653. <https://doi.org/10.3390/en10050653>
- Turton, H., Moura, F., 2008. Vehicle-to-grid systems for sustainable development: An integrated energy analysis. *Technological Forecasting and Social Change* 75, 1091–1108. <https://doi.org/10.1016/j.techfore.2007.11.013>
- V2G Data Hub, (2023). V2G data projects around the world.
- Visakh, A., Manickavasagam Parvathy, S., 2022. Energy-cost minimization with dynamic smart charging of electric vehicles and the analysis of its impact on

- distribution-system operation. *Electr Eng.* <https://doi.org/10.1007/s00202-022-01511-w>
- Wang, H., Qin, B., Wu, Q., Xu, L., Domingo-Ferrer, J., 2015. TPP: Traceable Privacy-Preserving Communication and Precise Reward for Vehicle-to-Grid Networks in Smart Grids. *IEEE Trans. Inform. Forensic Secur.* 10, 2340–2351. <https://doi.org/10.1109/TIFS.2015.2455513>
- Watson, Boudreau, Chen, 2010. Information Systems and Environmentally Sustainable Development: Energy Informatics and New Directions for the IS Community. *MIS Quarterly* 34, 23. <https://doi.org/10.2307/20721413>
- Watson, R., 2008. Green IS: Building Sustainable Business Practices. *Information Systems*.
- Williamson, O.E., (1973). Markets and Hierarchies: Some Elementary Considerations. *American Economic Review*.
- Xie, S., Zhong, W., Xie, K., Yu, R., Zhang, Y., 2016. Fair Energy Scheduling for Vehicle-to-Grid Networks Using Adaptive Dynamic Programming. *IEEE Trans. Neural Netw. Learning Syst.* 27, 1697–1707. <https://doi.org/10.1109/TNNLS.2016.2526615>
- Yao, W., Zhao, J., Wen, F., Xue, Y., Ledwich, G., (2013). A Hierarchical Decomposition Approach for Coordinated Dispatch of Plug-in Electric Vehicles. *IEEE Trans. Power Syst.* 28, 2768–2778. <https://doi.org/10.1109/TPWRS.2013.2256937>
- Yu, R., Zhong, W., Xie, S., Yuen, C., Gjessing, S., Zhang, Y., (2016). Balancing Power Demand Through EV Mobility in Vehicle-to-Grid Mobile Energy Networks. *IEEE Trans. Ind. Inf.* 12, 79–90. <https://doi.org/10.1109/TII.2015.2494884>
- Zarkoob, H., Keshav, S., Rosenberg, C., 2013. Optimal contracts for providing load-side frequency regulation service using fleets of electric vehicles. *Journal of Power Sources* 241, 94–111. <https://doi.org/10.1016/j.jpowsour.2013.03.179>
- Zhang, L., Zhao, Z., Xin, H., Chai, J., Wang, G., (2018). Charge pricing model for electric vehicle charging infrastructure public-private partnership projects in China: A system dynamics analysis. *Journal of Cleaner Production* 199, 321–333. <https://doi.org/10.1016/j.jclepro.2018.07.169>
- Zhang, S., Leung, K.-C., 2022. Joint Optimal Power Flow Routing and Vehicle-to-Grid Scheduling: Theory and Algorithms. *IEEE Trans. Intell. Transport. Syst.* 23, 499–512. <https://doi.org/10.1109/TITS.2020.3012489>
- Zheng, Y., Niu, S., Shang, Y., Shao, Z., Jian, L. (2019). Integrating plug-in electric vehicles into power grids: A comprehensive review on power interaction mode, scheduling methodology and mathematical foundation. *Renewable and Sustainable Energy Reviews* 112, 424–439. <https://doi.org/10.1016/j.rser.2019.05.059>
- Zhong, J., He, L., Li, C., Cao, Y., Wang, J., Fang, B., Zeng, L., Xiao, G., 2014. Coordinated control for large-scale EV charging facilities and energy storage devices participating in frequency regulation. *Applied Energy* 123, 253–262. <https://doi.org/10.1016/j.apenergy.2014.02.074>