



HAL
open science

DNA methylation levels and spontaneous mutations in Escherichia coli lambda phage

Magali Ventroux, Salomé Baltzinger, Lucas Du Breuil, Marina Elez, Marianne
De Paepe

► **To cite this version:**

Magali Ventroux, Salomé Baltzinger, Lucas Du Breuil, Marina Elez, Marianne De Paepe. DNA methylation levels and spontaneous mutations in Escherichia coli lambda phage. Phages in Lyon 2023, Nov 2023, Lyon, France. hal-04321532

HAL Id: hal-04321532

<https://hal.science/hal-04321532v1>

Submitted on 4 Dec 2023

HAL is a multi-disciplinary open access archive for the deposit and dissemination of scientific research documents, whether they are published or not. The documents may come from teaching and research institutions in France or abroad, or from public or private research centers.

L'archive ouverte pluridisciplinaire **HAL**, est destinée au dépôt et à la diffusion de documents scientifiques de niveau recherche, publiés ou non, émanant des établissements d'enseignement et de recherche français ou étrangers, des laboratoires publics ou privés.

DNA methylation levels and spontaneous mutations in *Escherichia coli* lambda phage

Magali Ventroux, Salomé Baltzinger, Lucas Du Breuil, Marina Elez and Marianne De Paep*
MuSE team, UMR1319 Micalis, INRA, Jouy-en-Josas, F-78350, France

During the cell cycle, replication errors can lead to spontaneous mutations, resulting in the appearance of genetic variants. Compared to their hosts, phages have much higher mutation and recombination rate, even those that use their host's replication machinery. The estimated mutation rate of dsDNA such as lambda phage is ~10-8 mutation/nucleotide/replication (m/n/r) i.e., ~100 times higher than that of its host *E. coli*. The highly conserved DNA Mismatch Repair (MMR) system corrects >90% of replication errors, significantly contributing to the avoidance of mutations. In *E. coli*, the key MMR proteins are the MutSLH complex, UvrD helicase, and Dam methyltransferase, which methylates newly replicated GATC sites. MutSLH uses the latency required for this methylation to recognize and cut the newly synthesized strand, triggering the repair. It has been shown that in lambda phage GATC sites are under-methylated, probably because the level of intracellular methylase Dam becomes limiting. We investigated whether lambda's high mutation frequency is due to inefficient MMR as a result of under-methylation of GATC sites. To this end, we characterized the effect of modulating *dam* expression on lambda DNA methylation levels and mutant frequency. Our results show that increase in Dam level has a mutagenic effect in lambda.

Context

E. coli Mismatch Repair (MMR)

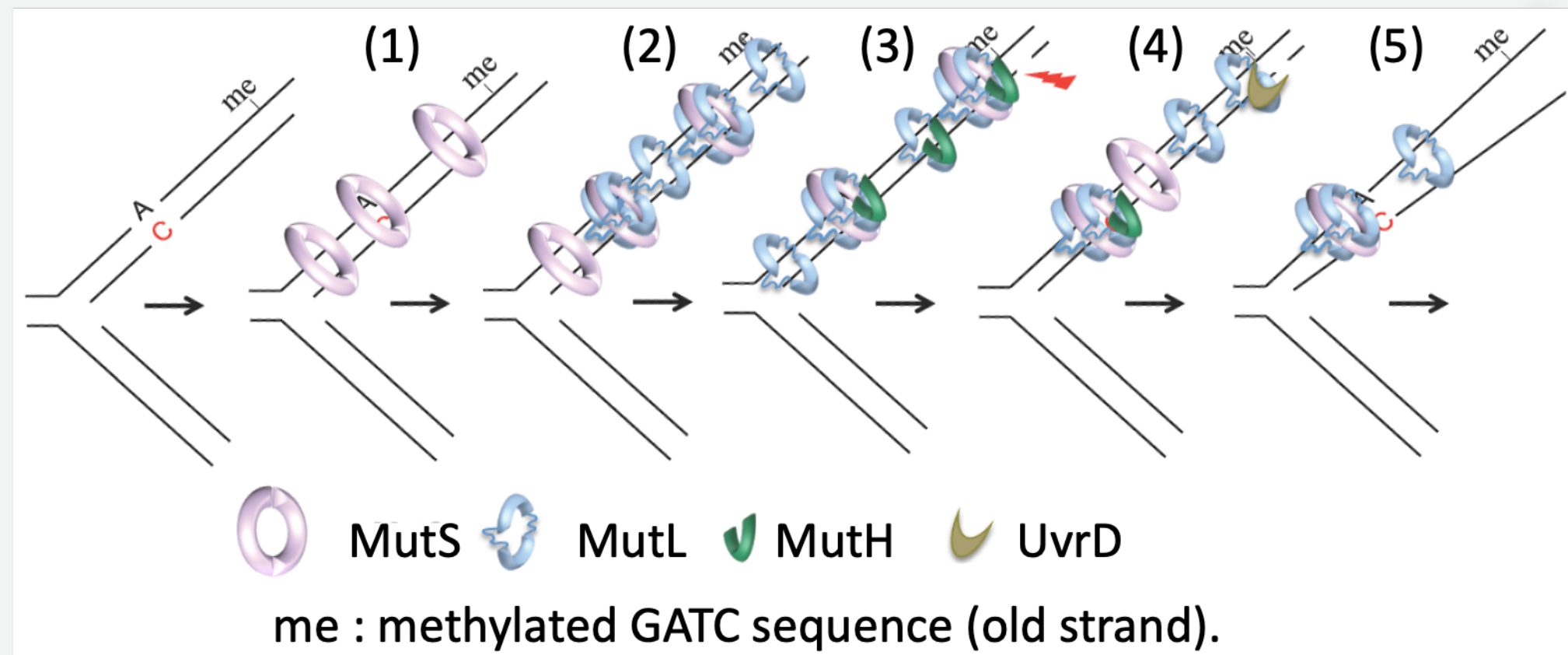

- (1) MutS dimer binds to a mismatch (replication error)
- (2) MutL dimers bind to sliding MutS
- (3) Endonuclease MutH binds to MutL or MutS-MutL complexes
Activated MutH incises the newly synthesized strand at the unmethylated d(GATC) sequence
- (4) MutL and UvrD assemble near the single-strand break
This allows unwinding of the portion of the newly synthesized strand beyond the mismatch
- (5) The unwound portion of the new strand is resected
→ DNA polymerase resynthesizes the excised strand, DNA ligase seals the nick (not shown)

(From Elez, 2021. Cells)

Lambda has much higher mutation rate than *E. coli*

- *E. coli* → ~6.10⁻¹⁰ mutations / nucleotide / replication
- lambda → ~8.10⁻⁸

(Drake et al., 1991. PNAS)

Dam methylation and mutation rate

- Dam methylase activity is insufficient during lambda DNA replication, resulting in under-methylation of lambda DNA at GATC sites (Szyf et al., 1984. PNAS)
- > hypothesis : intracellular Dam methylase level becomes limiting
- The mutation rate in *E. coli* *dam* cells is 10-20 times higher than in WT cells, due to the lack of strand discrimination. *E. coli*
- *E. coli* cells that overproduce 20-50 fold Dam methylase are hypermutable (Herman and Modrich, 1981. J. Bact., Marinus and al., 1984. Gene)

Does lambda have a high mutation rate because the under-methylation of GATC sites prevents MMR from working efficiently?

Fine modulation of *dam* expression

- ✓ *PLtet01-dam* : repressed by TetR (Lutz & Bujard 1997)
- ✓ The level of repression can be regulated by anhydrotetracycline (aTc)

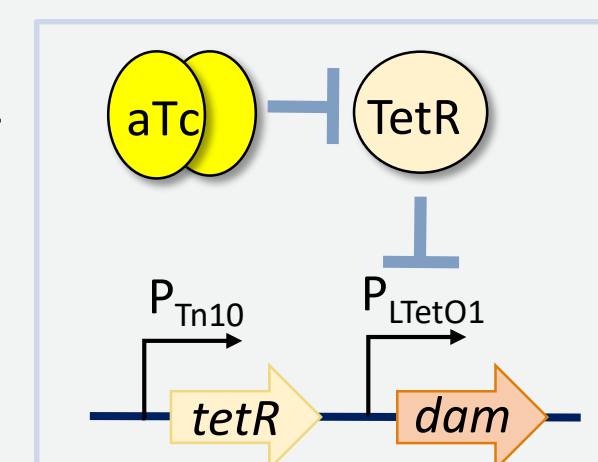

Characterization of the effect of *dam* level modulation on lambda DNA methylation and mutant frequency

Characterization of *dam* expression from *PLtet01*

Quantification of GFP fluorescence from *PLtet01-gfp*

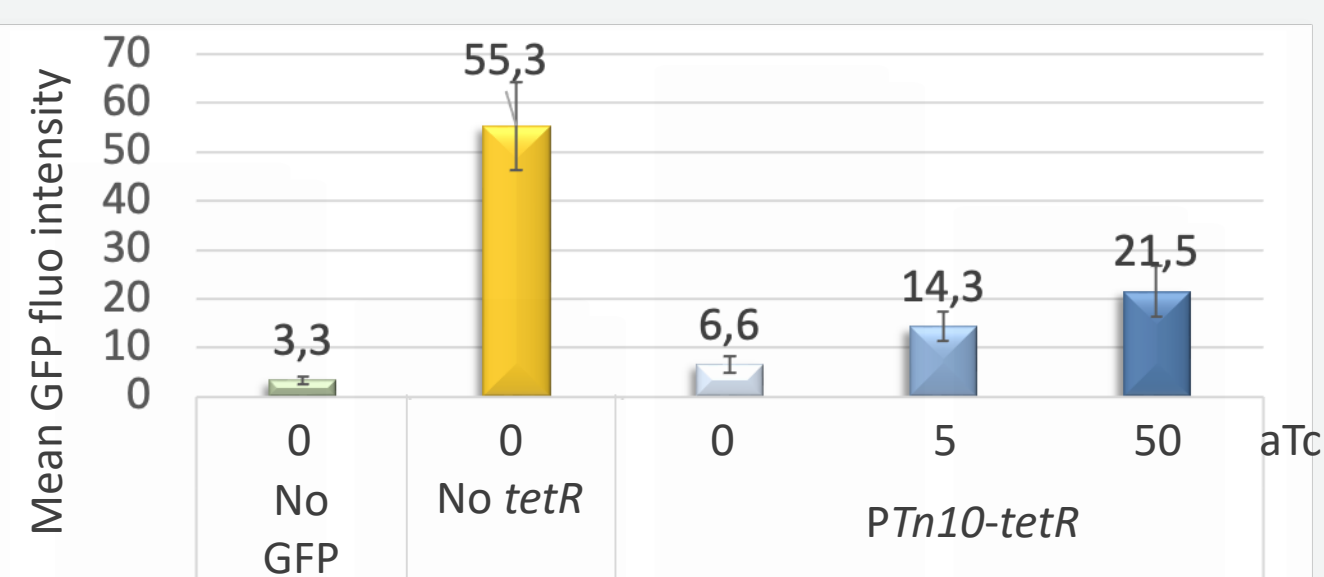

- Fine modulation of the level of expression from *PLtet01* can be achieved

Characterization of *PLtet01-dam* on *E. coli* mutagenesis

Quantifying the frequency of rifampicin resistant mutants

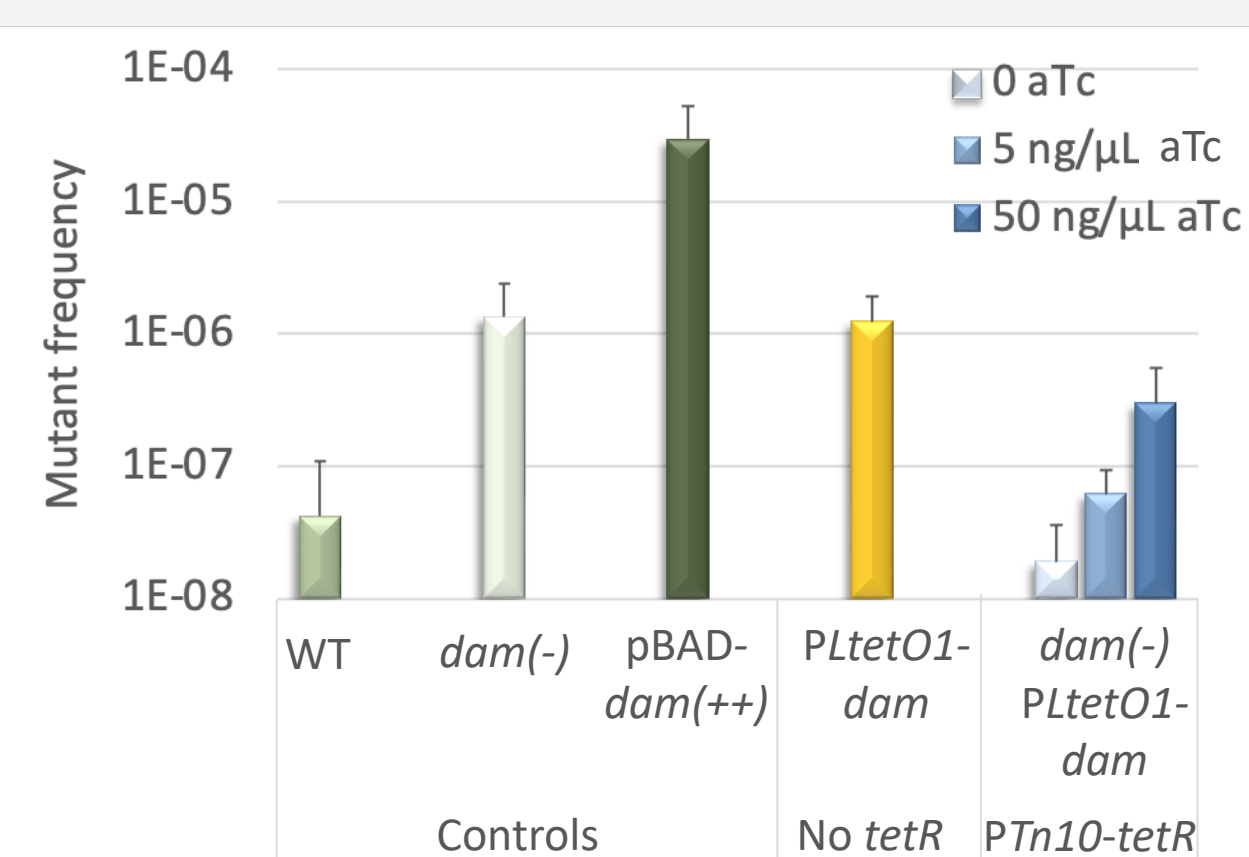

- Mutator effect in *dam(-)* and *dam(++)*
- Leakage from *PLtet01-dam* restores *dam(-)* mutagenesis phenotype

Effect of *dam* level modulation on lambda DNA methylation

- ☐ lambda was multiplied on strains with different levels of Dam
- ☐ lambda DNA was extracted and digested using Dam methylation dependant restriction enzymes

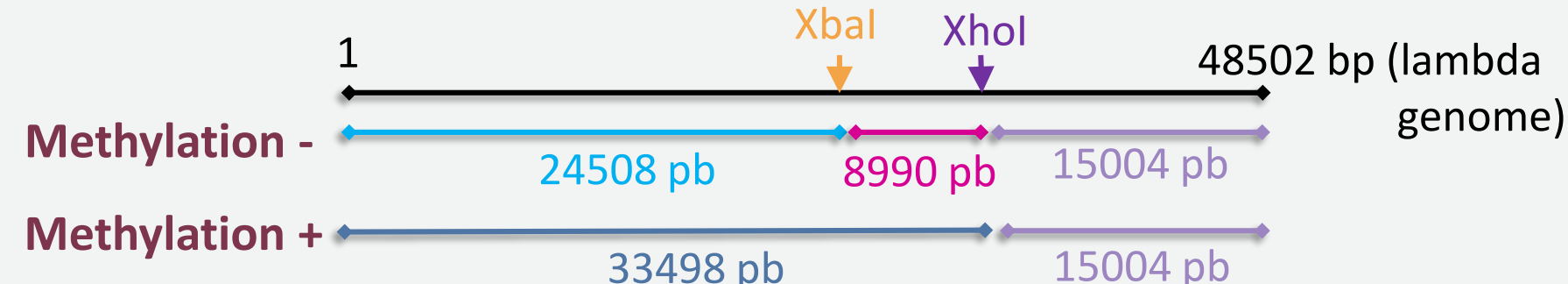
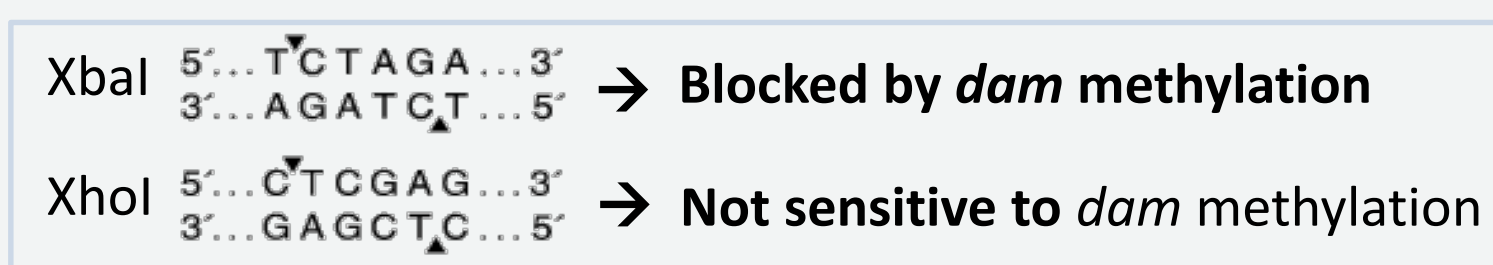

- ☐ restriction profile

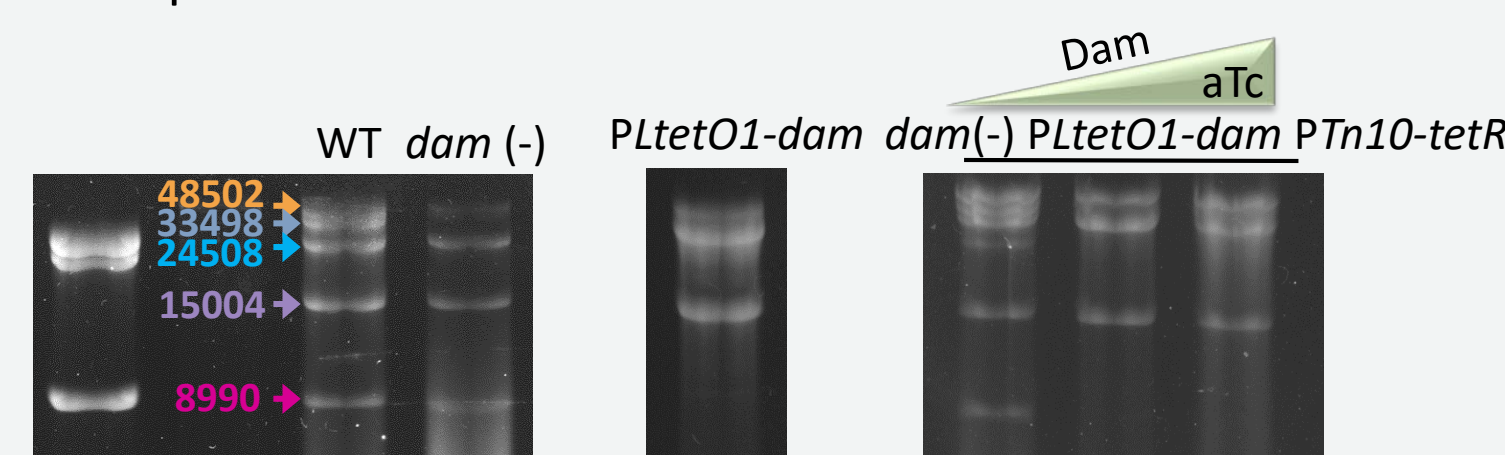

Quantification of GATC methylation levels

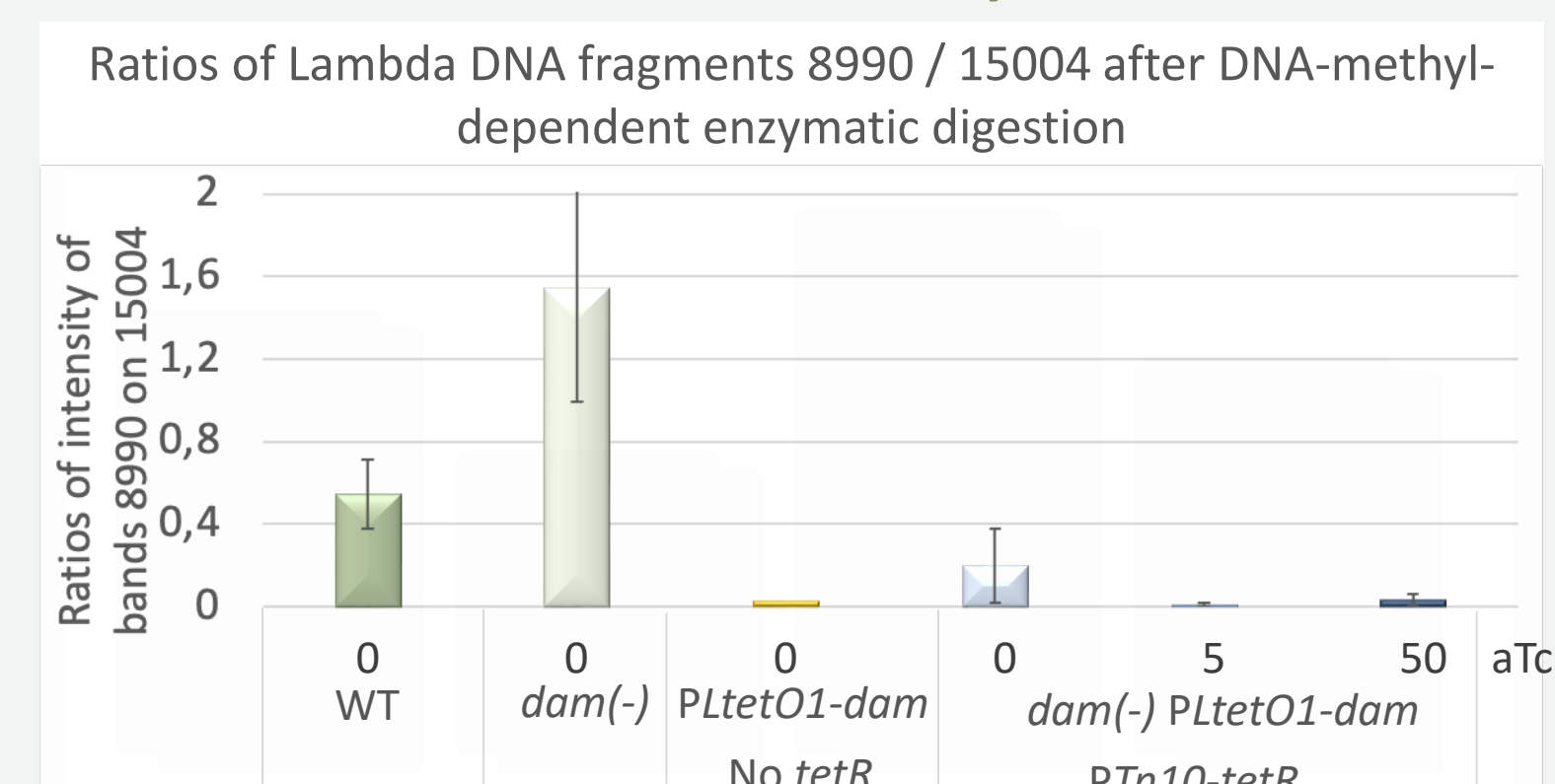

- Increased Dam levels lead to increased lambda DNA methylation
- Leakage of *PLtet01* (no aTc)

Effect of *dam* level modulation on lambda mutant frequency

- ☐ CII controls indirectly lambda lytic cycle
- ☐ Mutagenesis experiment: *cII* - mutants detected by growth on *E. coli* mutated for HflB protease

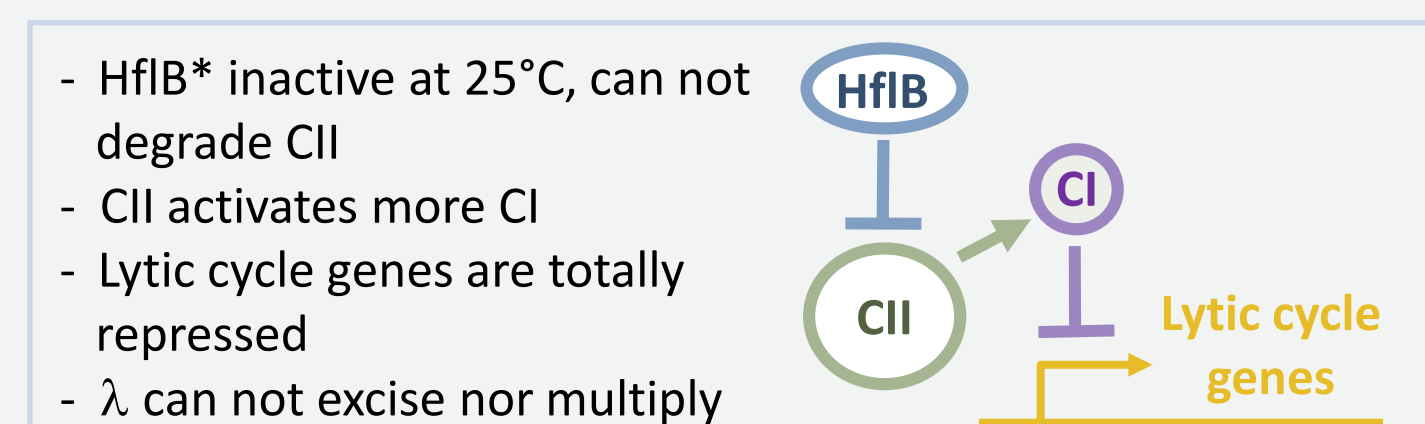

	<i>E. coli</i> WT	<i>E. coli</i> HflB*
lambda WT	lysis + lysogeny	100% lysogeny
lambda <i>cII</i> mutant	lysis + lysogeny	lysis + lysogeny

lambda mutant frequency

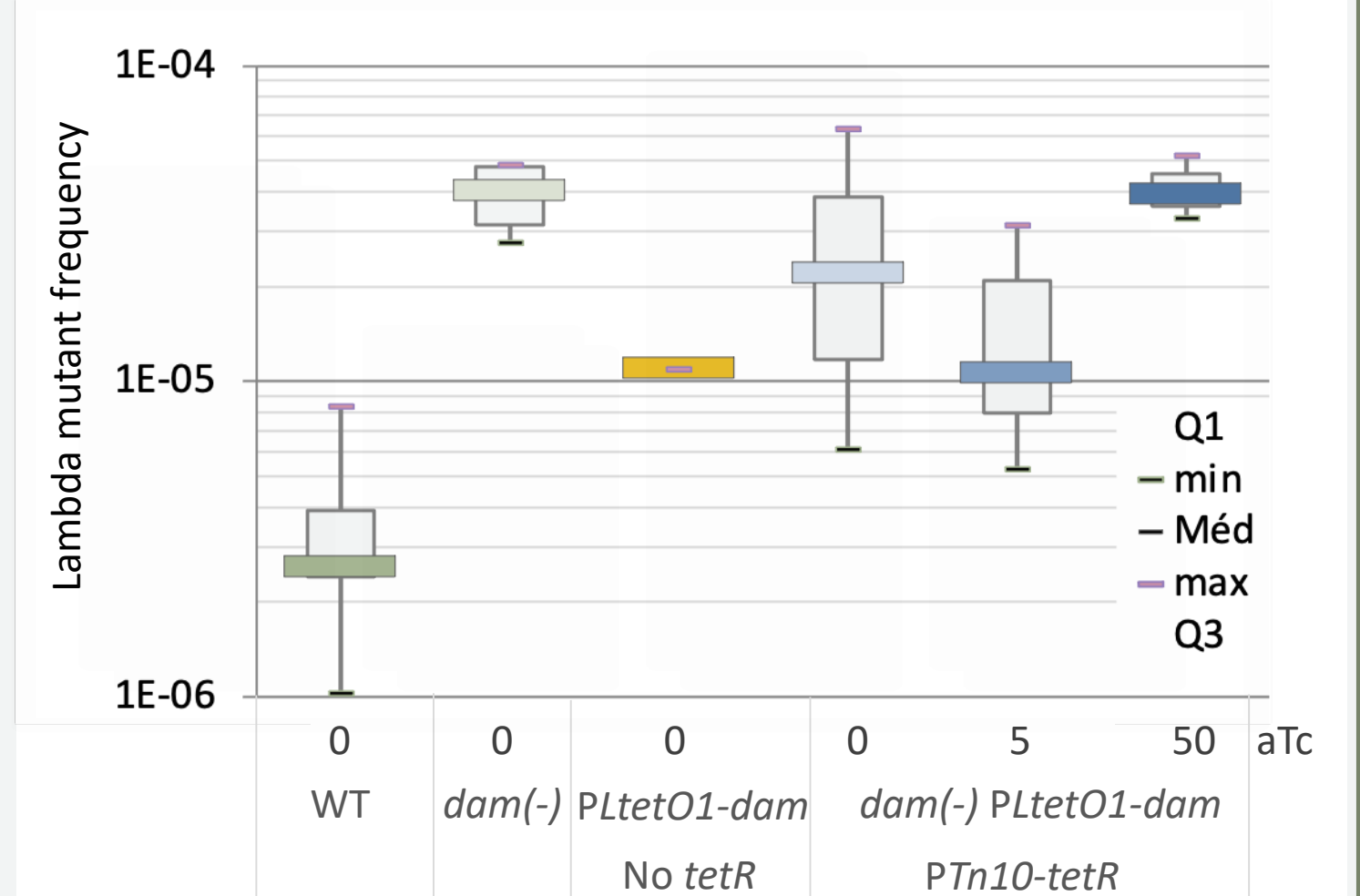

- Lambda mutant frequency increased ~ 10 times in *PLtet01-dam* *P_Tn10-tetR* (even with 0 aTc)

Modulation of *dam* expression has enabled us to find Dam levels that lead to increased lambda DNA methylation. These levels do not induce mutagenesis in *E. coli*. However, they do have a mutagenic effect in lambda. Further experiments with other promoters of different strengths, as well as quantification of Dam in cells, will help to clarify the role of Dam in lambda mutagenesis. Furthermore, DNA under-methylation may not be the only mechanism responsible for the elevated lambda mutagenesis. Further experiments will be needed to elucidate these additional mechanisms.