

Jean-Pierre Houdin

Honorary Architect

HIP.Institute* Co/founder, Administrator and General Secretary

(*ScanPyramids mission coordinator with the Faculty of Engineering, Cairo University)

Khufu's Pyramid,
recent discovery of a chamber-corridor under the North face
by the ScanPyramids mission

This corridor-chamber, designed by Hemiunu and Ankh-Haf, opens the way to the discovery of a series of corridors serving the Queen's Chamber, the King's Apartments and, most certainly, the BIG VOID.



François Schuiten for ScanPyramids

The "SP-NFC"

(The ScanPyramids - North Face Corridor)

STRABO'S PORTCULLIS CHAMBER Memoir

This text is part of a future trilogy, and was preceded by :

The BIG VOID

"Khufu's Pyramid,

recent discovery of a large cavity by the ScanPyramids mission".

it will be followed by

"Khufu's Pyramid,

recent discovery of a cavity under the NorthEastern edge by the ScanPyramids mission".

Jean-Pierre HOUDIN, CC BY-NC-ND 4.0 - Paris,

10/25/2023

(English translation by the Author)

STRABO'S PORTCULLIS CHAMBER

TABLE OF CONTENTS

1 - PREAMBLE.....	Page 2
2 - THE BIRTH OF A THEORY.....	Page 3
3 - 1999 - 2003: FIVE FOUNDING YEARS.....	Page 9
4 - 4 KEY POINTS TO UNDERSTAND THE HISTORY OF KHUFU'S PYRAMID....	Page 20
5 - 2ND HALF 2003, THE BEGINNINGS OF THE "NOBLE CIRCUIT" THEORY	Page 30
<i>Information note N°1</i>	Page 30
<i>Information note N°2</i>	Page 38
6 - EVOLUTION OF THE "NOBLE CIRCUIT" THEORY BETWEEN 2004 AND 2011	Page 43
7 - THE SCANPYRAMIDS MISSION AND THE DISCOVERY OF THE SECOND	
ENTRANCE CHAMBER.....	Page 54
<i>Information note N°3</i>	Page 54
8 - "GOOD LORD! BUT IT'S OF COURSE!".....	Page 79
9- LAYING THE RAFTERS FOR THE TWO ENTRANCE CHAMBERS.....	Page 85
<i>Information note N°4</i>	Page 85
10 - APPEARANCE OF THE TWO ENTRANCE CHAMBERS ON THE EVE OF	
THE FUNERAL.....	Page 115
11 - PATH OF THE SARCOPHAGUS DURING THE FUNERAL PROCESSION.....	Page 119
12 - SEALING THE SECOND ENTRANCE CHAMBER WITH STRABO'S	
PORTCULLIS.....	Page 122
13 - BACK TO THE 4 KEY POINTS.....	Page 132
<i>Information note N°5</i>	Page 140
14 - CONSEQUENCES OF THE DISCOVERY OF THE SP-NFC.....	Page 147
15 - EPILOGUE.....	Page 154
16 - THE MULTI-PURPOSE ENTRANCE TO THE GREAT PYRAMID.	
<i>Article published on the Pyramidales blog on February 25, 2011</i>	Page 156
17 - BIBLIOGRAPHY.....	Page 165
18- USEFUL INTERNET LINKS TO DISCOVER MY WORK.....	Page 167

RECOMMENDATION

Many of the illustrations in this document have been reduced in size to keep the number of pages to a minimum.

For best viewing, we recommend displaying the Pdf pages on your screen at +150%.

STRABO'S PORTCULLIS CHAMBER

TO HRH...

1 - PREAMBLE

On October 25, 2022, when I published my first memoir dedicated to the discovery of the BIG VOID¹ in Khufu's Pyramid, I indicated on the cover that it would be followed by two other documents of the same type to form a trilogy. The second, entitled "*Khufu's Pyramid, recent discovery of a corridor under the North face by the ScanPyramids mission*" was to deal with an anomaly detected by the non-destructive techniques used during this mission. First suspected by infrared thermography² as early as November 2015, this anomaly had then been detected by muography³ and announced in autumn 2016 as being linked to the presence of a linear "cavity"⁴ located at the rear of the⁵ limestone chevrons visible on the North face, just above the original entrance into the pyramid.

Numerous data collection campaigns were carried out by the Nagoya University team and the French CEA team⁶ between 2017 and 2019, with the latest results announced clarifying the nature of this cavity; it appeared to be a corridor, probably horizontal, situated between 17 and 23m high, in the meantime dubbed SP-NFC for ScanPyramids - North Face Corridor.

Despite a two-year slowdown due to the COVID-19 pandemic, analysis carried out by the Nagoya team continued in 2021. Furthermore, the arrival in the ScanPyramids mission of the Technical University of Munich⁷ also implementing non-destructive techniques, radar and ultrasound, would certainly provide new information regarding SP-NFC. That said, no new results had been announced before the publication of my Memoir on The BIG VOID.

Having started this second Memoir as early as January 2023, its title and structure were therefore based on the results known before October 25, 2022; they were to represent my interpretation of this "probable" corridor-shaped cavity, between 17 and 23m high, detected by muography behind the rafters, also called "chevrons" in this Memoir, above the North-facing entrance.

The surprise announcement on March 2, 2023 by the ScanPyramids team, following additional data collected by the University of Munich team confirming, using radar and ultrasound, the presence of a void at the rear of the upper pair of chevrons, disrupted my plans for this Memoir. It was no longer a question of extreme probability, but of the discovery, thanks to an endoscope that enabled us to view and film a video, of a "corridor-chamber" some 9 m long, 2.10 m wide and 2.30 m high, some 82 cm from the outside⁸ !

The discovery of a room of this size, unseen by a human being for over forty-five centuries, is the most important since Howard Vyse's 1837 discovery of the last⁹ chamber above the King's Chamber.

This discovery is therefore HISTORIC and must be treated as such, no more and no less!

¹ The BIG VOID – Khufu's Pyramid, recently discovered by the ScanPyramids mission.

² By infrared measurement specialist Jean-Claude Barré (France). See Le BIG VOID, page 4 note 17

³ By the Japanese muography team at Nagoya University led by Professor Kunihiro Morishima. See Le BIG VOID, page 5 note 35.

⁴ With a confidence index greater than 5 sigmas.

⁵ More precisely, two Turah limestone beams forming chevrons, each beam being also called rafter or chevron indistinctly.

⁶ Directed by Sébastien Procureur. See Le BIG VOID, page 20, note 117.

⁷ Directed by Christian Grosse and Johannes Rupfle.

⁸ The thickness of the rafters. See: La Pyramide de Khéops - Plan N°5 - ENTRÉE, by Gilles Dormion.

⁹ Named Campbell's Chamber.

STRABO'S PORTCULLIS CHAMBER

This document becomes, in effect, the story of a "discovery foretold", predicted in the summer of 2003¹⁰ following several years of research, reflection and study linked to solving the enigma of the construction of Khufu's Pyramid. Intensive use of 3D design software¹¹ enabled me to create several successive virtual models of the monument, examining it from a multitude of angles.

That said none of this would have been possible if an unexpected event hadn't upset the basic, unchallenged "Thought" that the pyramids were built from the outside. No satisfactory solution has ever been put forward, because this official paradigm is simply wrong!

No solution¹² is possible, as any attempt to do so is bound to hit a dead end at some point. Reality always ends up reminding us of the facts, i.e. what has been built and what we have before our eyes, Khufu's Pyramid being the finest example of the talent of the architects and engineers of Ancient Egypt, particularly those of the 4^{ème} Dynasty, led by Hemiunu and Ankh-haf.

This story began on January 2, 1999, with this simple phrase from my father Henri Houdin: *"If I had to build a pyramid, I'd build it from the inside"*. The basic paradigm was reversed, the problem was posed from a different angle, and the solution - or, more precisely, all the solutions/processes - answering all the questions posed, could gradually be linked together to finally solve the multi-millennial enigma.

Thanks to this new approach to the problem and thousands of hours of study, the official discovery of the SP-NFC, which I provisionally call the "Second¹³ Entrance Chamber¹⁴", is the key to confirming, through a domino effect, all the stages in the construction of the pyramid, from base to top, and opening the doors to other unknown rooms in the monument.

It's high time we retraced the History that led to this spectacular breakthrough in our knowledge of the pyramid because, in addition to the paradigm shift, a small detail that occurred at the outset was of inestimable importance in the discovery of the double Entrance Chamber.

2 - THE BIRTH OF A THEORY

On January 14, 1950, a four-engine Douglas DC4 (Skymaster) belonging to Air France took off from Orly airport near Paris at 11:00 a.m., bound for Dakar in Senegal. After two refueling stops in Bordeaux and Casablanca¹⁵, the aircraft finally lands at its destination at 8:00 pm. Passengers disembark, some having reached their destination while others, in transit, head for "Terme Sud¹⁶" for dinner and the night.

¹⁰ Twenty years before the March 2, 2023 announcement.

¹¹ With AutoCad 13 software for a total of around 5,000 hours between 1999 and 2006.

¹² I quote the subtitle of Chapter 3 of *Le BIG VOID*, page 7: "A problem without a solution is a problem badly posed" - Albert Einstein.

¹³ I use this term because it's obvious that, in place of the hole currently visible in front of the two pairs of rafters, there was a "First Chamber" overhanging the descending corridor. The two rafter remnants on the East side and the stoppers on either side attest to this.

¹⁴ The architectural shape of the roof is more akin to a "chamber" than a corridor. This term is more appropriate, given the dimensions, than "Portcullis Chamber" for the device inserted between the Grand Gallery and the King's Chamber. Further in this Memoir, I'll explain the name of this chamber in relation to a historical text that has survived the centuries.

¹⁵ In Morocco.

¹⁶ Former U.S. Air Force encampment on the supply line for the Battle of Libya during World War II.

STRABO'S PORTCULLIS CHAMBER

The following day, January 15, after waking up at 5 a.m. followed by breakfast, the passengers continuing their journey board a twin-engine Douglas DC3 (Dakota) of the same company at 7 a.m. for take-off to their final destination, Abidjan in Côte d'Ivoire, with two further stopovers planned at Conakry¹⁷ and Robertsfield¹⁸ for refueling. Finally, in the late afternoon and after a journey of over thirty hours, the plane land at Port-Bouët, Abidjan's airport located on a strip of land between the Ebrié Lagoon and the Atlantic Ocean. Passengers disembark and proceed to the airport building, a twelve-square-meter shack, to complete administrative formalities. Among these passengers, a young man presents his documents to the official on duty, who tells him:

"Welcome to Abidjan, Monsieur Houdin. You're young, not yet 27¹⁹, what do you do for a living, what's the purpose of your stay here?"

This passenger is my father answering his caller:

"I'm an engineer who graduated from the Ecole des Arts & Métiers²⁰, I work for a building and public works construction company, Entreprises Boussiron²¹, and my boss²² sent me here to set up and run²³ a subsidiary responsible for constructing bridges and buildings in this part of French West Africa".

Shortly afterwards, he left the airport for Abidjan in the car of a local entrepreneur who had come to welcome him. After a few kilometers of laterite road²⁴, the car enters in Treichville on the only bridge, a pontoon-bridge built in the early 30s, linking the lagoon strip to the Plateau, the heart of the Ivorian capital. At the time, he had no idea that this crossing would seal the beginning of an adventure that would start on January 2, 1999, almost half a century later.

The next day, he met Jean Millier²⁵, the young interim director of public works in Côte d'Ivoire, who had already entrusted him with two missions:

- make an inventory of "Whales²⁶" bays from the Mulberry B²⁷ artificial harbor built on June 6, 1944 at Arromanches for the Allied landings in Normandy²⁸ and unloaded at the Wharf²⁹ in Port-Bouët.
- Crisscrossing the country to identify bridges in urgent need of rebuilding...

Following these missions, S.E.T.A.O.³⁰ was created by my father, who took over its management. The first construction projects could then get underway, with the start of three bridges that would usher in an era of major works and, above all, pave the way for a major civil engineering project, the replacement of the floating bridge between Treichville and the Plateau.

¹⁷ In Guinea.

¹⁸ Monrovia Airport, Liberia - Firestone Plantation, also on the supply chain for the Battle of Libya.

¹⁹ He'll have them in May.

²⁰ One of the oldest engineering schools, founded in 1780 by the Duc de La Rochefoucault-Liancourt.

²¹ Originally founded in 1899 by Simon Boussiron and Antoine Garric, two Arts & Métiers engineers, under the name Simon & Garric, then Boussiron in 1906 and Entreprises Boussiron in 1929. The company became part of the Bouygues group in 1974. Simon Boussiron developed the use of reinforced concrete from 1900 onwards.

²² Jacques Fougerolles, son-in-law of Simon Boussiron, who succeeded him at the head of the company in 1936.

²³ My father had just finished rebuilding the pont de fin d'Oise in Conflans Sainte-Honorine. Boussiron's managers had been impressed by his remarkable management of the site.

²⁴ Laterite is a red soil. At that time, there were only 8 km of paved roads outside Abidjan.

²⁵ A 36-year-old Ponts et Chaussées engineer, he was later responsible for the La Défense business district near Paris. He later presided over the Centre Georges Pompidou - Beaubourg - and the Institut Français d'Architecture.

²⁶ 24 m-long metal roadways (spans) linking the unloading docks to the shoreline.

²⁷ Code name given to the artificial harbours built for Arromanches and Omaha Beach.

²⁸ After the war, the French administration sent a number of these spans to Africa to replace old wooden bridges with more modern structures built in concrete and these famous metal spans.

²⁹ A metal jetty, perpendicular to the beach, where ships could dock on either side.

³⁰ Société d'Etude et de Travaux pour l'Afrique Occidentale.

STRABO'S PORTCULLIS CHAMBER

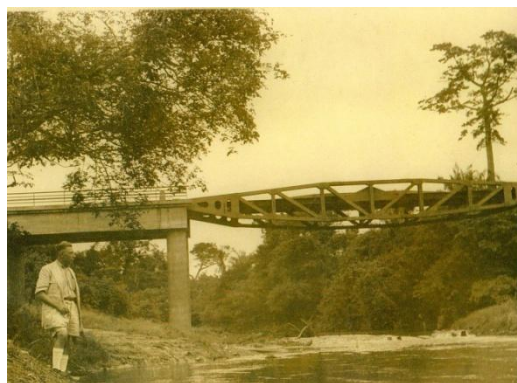

In 1954, my grandfather Henri Houdin³¹ visited the bridge over the Kô river near Man, close to Liberia, built with one of the metal "Whales" from the Mulberry B port at Arromanches, salvaged after the Second World War.

On July 29, 1950, my mother, a young medical doctor³², and my brother Bernard, who was celebrating his first birthday³³, arrived on board the Brazza³⁴. They disembarked at the Port-Bouët wharf in a wicker basket. Born in Paris in June 1951, I arrived in Abidjan by plane with my family at the end of the summer, at the age of two and a half months, and lived there until the summer of 1962, at the age of eleven³⁵.

Thanks to the success of the work carried out in the early years, and Jean Millier's determination to develop the city of Abidjan, studies were launched in 1952 for the construction of a road and railroad bridge to replace the existing pontoon-bridge. In August 1954, a contract was signed for a road and rail bridge made of prestressed concrete box girders, designed by engineer Nicolas Esquillan³⁶, Boussiron's director of technical studies, and architects Badani and Roux-Dorlut; it was built by a consortium of companies³⁷ led by S.E.T.A.O.

The bridge will cross the lagoon above a water depth of some fifteen meters, under which lies an enormous layer of mud some thirty meters thick, itself laid on muddy sands and frank sands down to a depth of -65m. A thorough study of the soil geology was required before any work could begin, so a top-level expert in soil mechanics was called in, engineer Jean Kérisel³⁸, founder of the SIMECSOL engineering firm.

The stakes are high, as the technique used to support the box girders is a world first devised by Nicolas Esquillan: they will be placed on prefabricated caissons³⁹ on the banks, which will themselves be supported by piers measuring up to 70m in height, judiciously arranged in four vertical and four

³¹ My great-grandfather, grandfather and father were all called Henri, only the middle name differed. My mother vetoed it, not wanting me to become "Henri IV". My name is...Jean-Pierre Henri...

³² His profession will also play an unexpected role in the Khufu adventure, see next page.

³³ July 29, 1950 was a historic day in Côte d'Ivoire: the "plug" that still closed the Vridi canal linking the Ebrié lagoon to the sea was "exploded", paving the way for the development of the port of Abidjan.

³⁴ A liner belonging to the Compagnie Maritime des Chargeurs Réunis. Shortly afterwards, it was the first ship to enter the port of Abidjan via the Vridi canal. The port of Abidjan was inaugurated on February 5, 1951, in the presence of François Mitterand, Minister for Overseas France and future President of the French Republic from 1981 to 1995.

³⁵ The family returned to France for good, allowing us to continue our secondary education at the Lycée Carnot in Paris. My father would continue to manage S.E.T.A.O. from Paris, making frequent trips there until 1970.

³⁶ He was also an engineer from the Ecole des Arts et Métiers, and my father's mentor when he graduated from the same school.

³⁷ Boussiron, Dragages et Travaux Publics and S.E.T.A.O.

³⁸ A graduate of the Ecole Polytechnique and the Ponts et Chaussées engineering school, he holds a doctorate in physics from the Sorbonne. Later, in 1968-1969, he was President of the CNISF (see Le BIG VOID, page 2 note 5).

³⁹ Like the box girders

STRABO'S PORTCULLIS CHAMBER

inclined pairs. In the absence of hard points, it is the combined effect of point and lateral friction that ensures the anchoring force of the piers.

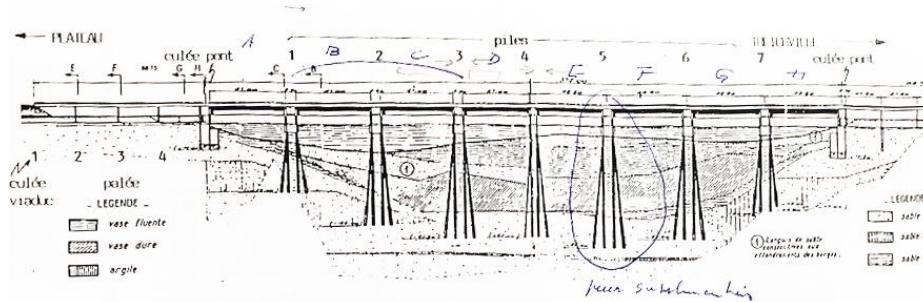

Longitudinal section showing the structure of the first Abidjan bridge.
It's easy to see why the specialist Jean Kérisel was commissioned to carry out a detailed soil survey.

At the beginning of September 1954, Jean Kérisel arrived in Abidjan to begin his mission, but after a few days of work, he suddenly fell ill and had only one wish: to return to France as soon as possible. My father asked my mother to do everything in her power, as a doctor, to cure the engineer so that he could resume his vital mission. Finally, within a few days, Jean Kérisel was back on his feet⁴⁰ and resuming his mission as if nothing had happened.

After less than three years of construction, the bridge was opened to traffic in June 1957⁴¹ and immediately contributed to the expansion of the city of Abidjan, both to the North and to the South. As the bridge quickly became saturated⁴², the project to build a second bridge became an obvious priority. At the request of the government of the new Republic of Côte d'Ivoire, SOFITOM⁴³ stepped in to study the project in its entirety: financial, prospective and technical. Thanks to a financial package⁴⁴ guaranteed by the French government, construction of the second bridge began on August 1^{er} 1964 and was delivered a month ahead of schedule on July 1, 1967, being named the Charles de Gaulle Bridge. It was built by the same group of companies⁴⁵ led by S.E.T.A.O., as for the first bridge⁴⁶. Jean Kérisel was once again called in to carry out the soil survey for the foundations, which, thanks to the use of much more sophisticated drilling equipment than ten years earlier, virtually eliminated all the hazards associated with the process, which was still, at the time, unrivalled anywhere in the world.

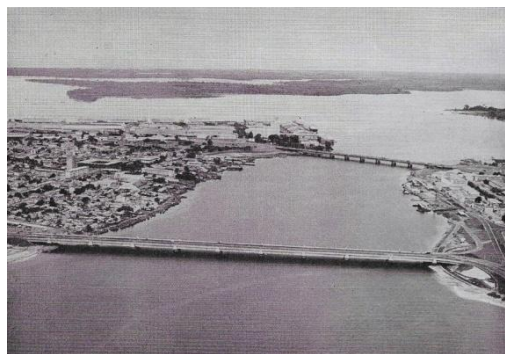

In the background, the first Félix Houphouët-Boigny bridge, delivered in 1957.
In the foreground, the Charles de Gaulle Bridge, delivered in 1967, the year of the photo.

⁴⁰ Jean Kérisel will always hold my mother in high esteem for having "saved" her in this tropical country far from France.

⁴¹ It was officially inaugurated on March 15, 1958 by Gaston Monnerville, President of the Council of the French Republic (today's Senate) and Félix Houphouët-Boigny, Minister of Health and future first President of the Republic of Côte d'Ivoire, with the first bridge named after him.

⁴² In just four years, vehicle traffic had risen from 20,000 a day in 1957 to 50,000 in 1961.

⁴³ SOFITOM, Société Financière et Industrielle pour Travaux d'Outre-mer, with my father as director.

⁴⁴ Thanks to this financing, Côte d'Ivoire will be able to pay for the bridge in eight years out of the national budget.

⁴⁵ See Note 37, previous page.

⁴⁶ The architect of the second bridge was François Chomette.

STRABO'S PORTCULLIS CHAMBER

In the ten years between 1957 and 1967, Abidjan was equipped with two modern bridges designed by talented engineers and architects, which were the driving force behind the development of the city and the country. It would be 46 years before a third⁴⁷ structure, the Henri Konan-Bédié Bridge, linked the coastal strip to the Cocody district.



My father Henri and my mother Renée, photo taken in Abidjan in the early 50s.

That said, several decades later...

In the early 90s, a rumor began to circulate in Abidjan: underwater divers had inspected the piers of the Félix Houphouët-Boigny Bridge as part of a maintenance operation, and had discovered concrete degradation on some of them, which could be due either to lagoon conditions or to impacts from pinasses⁴⁸. This rumor eventually reached the ears of my father, a member of the CNISF Civil Engineering Committee⁴⁹. Knowing well the nature of the foundations, he decided to contact all those involved in the construction of the bridge still alive⁵⁰ in order to create a CNISF Expert Committee to study the potential risks, the aim being to avoid a possible catastrophe. In the end, the "Jean Millier" College of Experts, chaired by my father, was set up with a eight members⁵¹.

After almost five years of work, the College of Experts will submit its conclusions which will ultimately be given to those concerned and I will talk about it again at the end of this Memoir; a few years later, the recommendations of the College will be taken into account, a call for tenders being launched for the reinforcement of the piers of the Félix Houphouët-Boigny bridge. The work will only begin in April 2018⁵² and will be completed in... 2023!

In the meantime, my father will be invited by the Ivorian government to the ceremonies celebrating the 50^{ème} anniversary of the independence of the Republic of Côte d'Ivoire, on August 7, 2010. On that day, he will be elevated to the rank of "Commandeur de l'Ordre National de Côte d'Ivoire" by the President of the Republic⁵³ for his contribution to the country's economic development during the period known as the "Ivorian Miracle"⁵⁴.

⁴⁷ Two other bridges have also been built, the last of which will open to traffic in summer 2023.

⁴⁸ Boats carrying passengers or goods sailing in large numbers on the lagoon

⁴⁹ See Note 37, page 5.

⁵⁰ Nearly thirty-five years had passed since the construction work was completed.

⁵¹ Including Jean Millier, Jean Kérisel, André Ferré (site manager) and René Perzo (engineer of the 2 bridges).

⁵² A serious political crisis having paralyzed the country's activity for many years.

⁵³ His Excellency Laurent Gbagbo.

⁵⁴ A period that stretched from the early 50s to the early 90s.

STRABO'S PORTCULLIS CHAMBER

On April 18, 2005, my father sent me a note⁵⁵ that he had written for me about meetings of the College of Experts, tracing the history of an anecdotal event that led to the famous phrase: *"If I had to build a pyramid, I'd build it from the inside"*.

Jean-Pierre,

Origins of Operation Khufu

Early 1990s:

- *College Jean Millier for the Houphouët-Boigny Bridge: presence of Jean Kérisel.*
- *In private we joke: he "turned"⁵⁶ in the pyramids....*
- *I read in a magazine about the publication of Kérisel's book, "KHEOPS⁵⁷, Génie et démesure d'un Pharaon" (May 96).*
- *I buy the book and browse through it to tell him about it as a courtesy.*

Meeting of 27.03.97 :

- *Kérisel writes me his dedication. At the end of the session, we talk about pyramids with the members.*

During 1998 :

- *At a College meeting: Kérisel alludes to a recent trip to Egypt and his "tiring climb" inside Khufu for a TV documentary.*

Late December 1998 :

- *I discovered in the TV magazine that a program by François de Closets is scheduled for January 1, 1999.*

New Year's Day 1999:

- *We are invited to lunch at M.... in Pargny-Filain: I program the recording⁵⁸ .*

October 1999 :

- *Article on the internal ramp in the CNISF magazine.*

CONCLUSION: Operation Khufu is a child of Abidjan's first bridge.

Dad

No one else can say more about the origin of our Pyramid Adventure!

Recently, I watched this documentary again and was struck by three sentences uttered at the end of the presentation of possible construction theories by two hosts:

Audran Labrousse: *"Even if we find a perfect theory, there's nothing to say that it's the same one that would have been used; it remains speculation, that's all. You can't believe in a theory until there's absolute proof: it could be a bas-relief, a text, an unfinished pyramid, something. We can only hope for chance: it could be tomorrow, or maybe never. Construction is always a mystery"*.

Egyptian Egyptologist: *"There's no mystery; we're ignorant, we lack the information to solve problems"*.

Audran Labrousse: *"It could be the chance of a lucky discovery"*.

⁵⁵ At the time, I was preparing a lecture to be given at the Société des Ingénieurs des Arts et Métiers on June 5, 2005 - see Le BIG VOID, page 2 note 8.

⁵⁶ Jean Kérisel had been asked to carry out a soil survey during the construction of the Cairo metro. During his frequent visits to Cairo, he had become fascinated by the pyramids of Giza. Chance once again.

⁵⁷ Génie et démesure d'un Pharaon - KHÉOPS, Jean Kérisel - Editions Stock. 1996

⁵⁸ On January 2, 1999, he watched the documentary "Le Mystère des Pyramides" and was astounded by the theories put forward by Egyptologists for the construction of the Great Pyramid; they made no sense, immediately imagining that it would be much simpler to build it...from the inside!

STRABO'S PORTCULLIS CHAMBER

I said to myself that if my father had never pressed the button on his VCR to watch this documentary, it wouldn't have a wrinkle, but chance, having taken the form of what I've recounted in this chapter, "made it really old"!

In twenty-five years of work, we have contributed a library of information to the knowledge of the pyramid, and the solution to the construction enigma is at hand. The discovery of the SP-NFC is already absolute proof that some of this work has paid off.

3 - 1999 - 2003: FIVE FOUNDINGS YEARS

Energized by his original idea in the face of a problem that has been without a solution since time immemorial, my father then begins a succession of sketches to materialize his vision of the technical process. An engineer accustomed to dealing with the civil engineering problems of his time, but with no knowledge of the know-how and techniques in use in Ancient Egypt, he reacted naturally from this time. The first three drawings, produced on January 4, 1999, reflect his state of mind as he concretized his innovative reaction to the documentary.

The drawings below may now seem a little simplistic compared to the stakes involved in building a pyramid weighing 5.5 million tons of stone. In reality, they're not, because they herald a break in the way we approach the problem of this construction: the paradigm has changed, the building site is now assumed to have been built from the inside and no longer from the outside, regardless, at this stage, of the form the process takes.

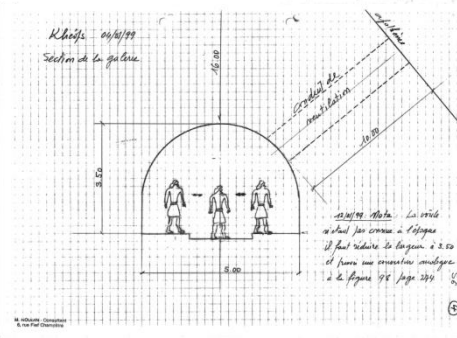
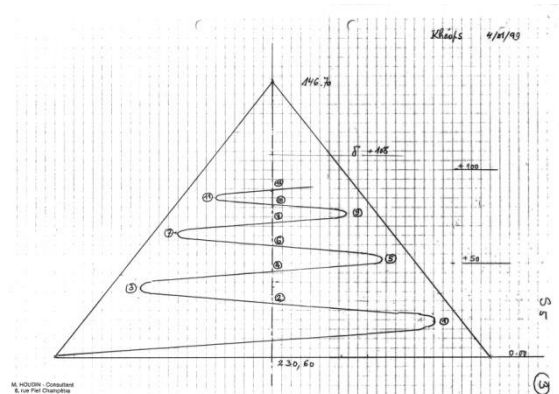
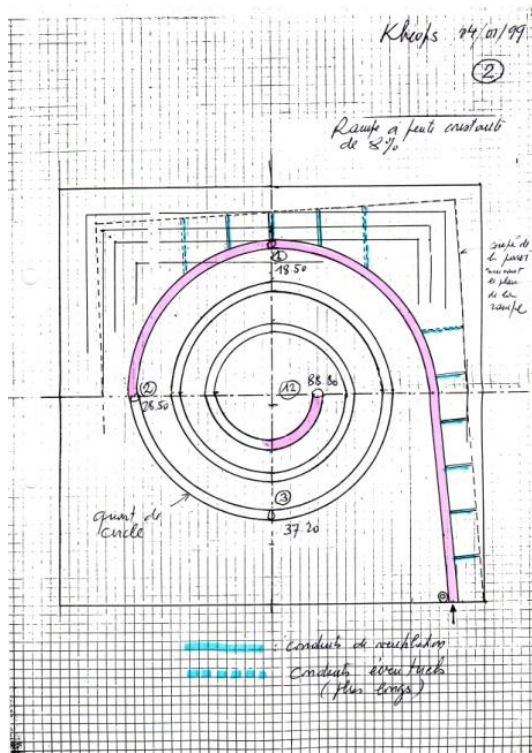

The first three drawings of my father's internal ramp concept, dated January 4, 1999. On the left is a plan view of an ascending spiral ramp inside the pyramid's volume, starting from the lower right-hand corner of the pyramid and developing counter-clockwise to reach a height of 88.80 meters. Air shafts open to the outside provide ventilation.

Top right, cross-section of the ramp and bottom, section of the tunnel and a ventilation shaft.

The purpose of this Memoir is not to deal exhaustively with the development of the internal ramp as it emerged at that precise moment until the discovery by the ScanPyramids mission of Cavity C1 under the Northeast edge in November 2015. This topic will be the subject of the third Memoir in the announced trilogy: "Khufu's Pyramid, recent discovery of a cavity under the North-East edge by the ScanPyramids mission ". That said, in this first plan drawing, the reasons that led to the discovery of the SP-NFC anomaly, which eventually became an "Entrance Chamber" officially part of the pyramid's interior architecture, are already there, unsuspected by anyone.

It is in this context that I will address certain elements of the theory of the internal ramp, more specifically the evolution of its configuration in its lower part, from the base to the +43 m level, the floor level of the King's Chamber, particularly its spatial geometry within the volume of the pyramid. I won't go into the architectural and technical features of the internal ramp, which have evolved considerably from the original to its latest known iteration⁵⁹. On the other hand, I can already say that an update of this ramp will also be announced with the third Memoir.

At the beginning of 1999⁶⁰ my father tells me of his original idea and, as an engineer faced with a construction problem, of his desire to further study the feasibility and advantages of his proposal. I also sense his desire to talk to his friend Jean Kérisel about it, to get his opinion as a pyramid specialist. So began a period of calculations concerning journey lengths, transport times, material supply rates and other parameters encountered on modern building sites. Following on from the first drawings, he adapted his basic idea to various solutions, multiplying the ramps according to the options. For my part, I'm delighted to see him so active⁶¹, thinking that this was the kind of action he'd enjoyed all his working life, and that it could only be positive for him in every way. So I follow his studies with a watchful eye, encouraging him in his project.

In late spring, my father had the opportunity to present a first detailed study of his theory to Jean Kérisel at a meeting of the "College Jean Millier": the verdict was harsh, as the objections were perfectly founded. Following this setback, he asked for my advice as an architect and my help in trying to save his original idea; my first reaction was to reassure him that his idea was "brilliant", but that it was absolutely necessary to transpose it to the time of the pyramids and try to find out what was known about the know-how and techniques used in Ancient Egypt. I promise to make a few 3D models, if necessary, to help visualize the concept.

Finally, in October 1999, the CNISF⁶² offered my father⁶³ two pages in its magazine *id*⁶⁴ to present this new theory devised for the construction of Khufu's pyramid. After an introduction recalling Herodotus and his "Relation de Voyage en Egypte" circa 650 B.C., the countless publications on the subject of pyramids and the three methods advocated - machines, straight ramp or enveloping helical ramp⁶⁵ - the article developed on the evolution of the new theory from its inception. The basic principles of building from the inside were enumerated: supply of materials, placing of facing blocks already surfaced to their final shape, absence of surplus at the end of construction and various other advantages.

⁵⁹ In other words, the ramp with two levels separated by an intermediate stone floor, as presented on January 27, 2011 at the Géode with "Khufu Reborn". See Le BIG VOID, page 4.

⁶⁰ I was in New York for a few weeks.

⁶¹ Retired for a dozen years, he had gone through a very difficult period in terms of health five years earlier, surviving cancer, a series of operations and cardiac arrest on the eve of his discharge after more than three months in hospital. He was finally discharged a month later, having lost over 30 kg. At the time, he spoke of his second life beginning!

⁶² See note 37 on page 5.

⁶³ Article co-signed by Henri Houdin, Ingénieur des Arts & Métiers (Paris 1941), Member of the CNISF Civil Engineering Commission and Jean-Pierre Houdin, Architecte DPLG (Paris 1976).

⁶⁴ *id* N°62 - October 1999, pages 5 and 6. The Construction of the Pyramids (*id* meaning "*ideas*").

⁶⁵ None of these three propositions could ever be supported by any text, drawing or clue.

STRABO'S PORTCULLIS CHAMBER

The article was illustrated with three plan drawings representing the evolution of the theory, the first being the original, the second an extrapolation using a network of four internal helical ramps and the third the⁶⁶ solution we had arrived at after a few months' reflection and a better knowledge of the building art⁶⁷ in Ancient Egypt. The latter would later become the basis of the so-called "internal ramp" theory, which evolved towards greater logic and simplicity over the years of work devoted to perfecting it, and thanks to the clues gathered over time.

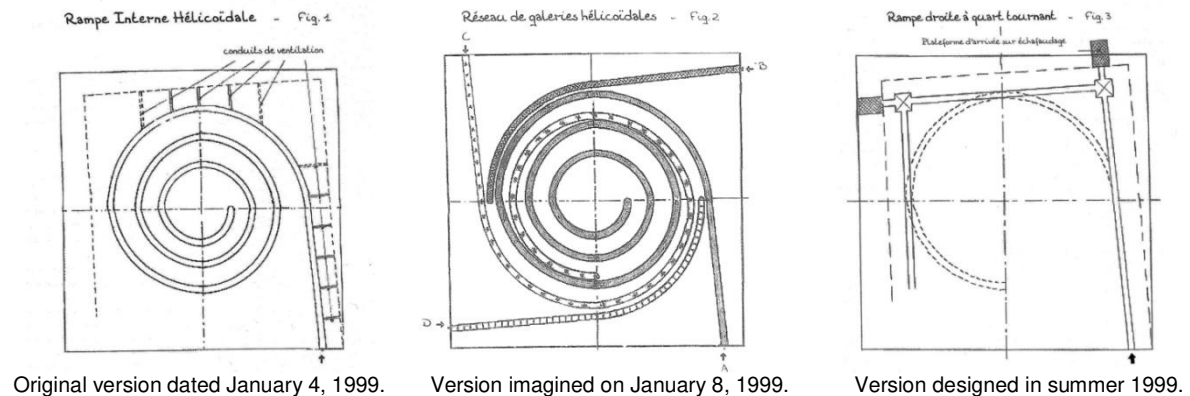

After a description of the advantages and disadvantages of the first two versions, the internal helical ramp and the helical gallery network, on page 6 of the review, it was written for the third:

"Another solution is the Straight ramp with quarter-turns (fig. 3). Each flight is equidistant from the face and opens onto the perpendicular wall. A platform is provided at the corner for pivoting the sled. The human team breaks up and re-forms easily in the perpendicular gallery. A special team turns the sled using levers. Meanwhile, the haulers rest. The gallery is narrower and the masonry load above it is low, allowing it to be covered with corbelled blocks as was common practice. As all unnecessary openings are systematically plugged, the galleries are filled at the end of their useful life, as they descend, the materials being delivered by sledges close to the working front and then transported by hand. As the nature of the material is identical to that of the main structure, it would be difficult to prove the presence of such galleries by simple exploratory drilling, and to locate the separation between the gallery walls and the filling. Only specialists would be in a position to say whether, in the course of their explorations of the various cavities, they had found any as yet unexplained anomalies in the walls that might result from the intersection of these cavities with filled-in construction galleries".

I wrote above: "... in this first plan drawing, the reasons that will lead to the discovery of the SP-NFC anomaly, which has finally become an "Entrance Chamber" officially part of the pyramid's interior architecture, are already there, unsuspected by anyone".

The reasons for this are to be found in the first and third versions: the internal ramp starts in the South-East corner of the pyramid and spirals upwards in a counter-clockwise direction. The change from a helical to a quarter-turn ramp sealed the fate of the "Entrance Chamber" on the North face!

⁶⁶ In a letter to Jean Kérisel dated October 28, 1999, my father wrote:

"Dear Mr. Kérisel,

Your first objection was an important one: how could a convoy that had to pull straight do it on a circular track?

The second concerned the Egyptians' ignorance of the semicircular arch.

My son Jean-Pierre*, an architect, came up with the straight ramp with quarter-turns that meets these requirements (*you met him in Abidjan at the age of 3!).

⁶⁷ With, for example, the introduction of the corbelled vault to cover the internal ramp.

STRABO'S PORTCULLIS CHAMBER

On October 10, 2000, the first advances in the development of our ideas were compiled in a twenty-page document entitled:

BUILDING PYRAMIDS

STRAIGHT RAMP WITH QUARTER-TURNS

Microgravimetric Endoscopy research program

MEMORY

The first page began with :

"INTRODUCTION

*In the October 1999 issue of **id**, published by the Conseil National des Ingénieurs et Scientifiques de France (CNISF) (French National Council of Engineers and Scientists), we published a thesis on the construction of the Pyramids, proposing a search for the ramps used to build them, using a solution known as: Straight ramp with quarter-turns.*

Recently, however, we learned⁶⁸ that in 1986 and 1987, EDF and the Compagnie de Prospection Géophysique Française (CPGF) had jointly carried out missions, at the request of the Egyptian Antiquities Committee in Cairo, to apply a cutting-edge technique, microgravimetry, to gain knowledge of the internal structure of Khufu's Pyramid, the aim being to discover an inviolate chamber that had remained unsuccessful. We were totally unaware of this event, although it did receive some press coverage.

Thanks to Mr. Daniel Brizemeure, Director of the skills sponsorship at the EDF Foundation, and Mr. Pierre Delétie, an EDF geologist and geophysicist who took part in the research carried out in 1986-87, using Microgravimetric Endoscopy (EMG), it has been possible to compare our thesis with the results obtained at the time. It appears that "anomalies" which had astonished the experts could demonstrate the validity of our thesis, as we explain in this memorandum.

These "abnormal" results were never published and would have been completely forgotten, had it not been for Mr. Delétie's immediate synthesis of the two issues at our first meeting. We are very grateful to Messrs Brizemeure and Delétie for having made it possible to reconcile these hypotheses, some fifteen years after the event.

This introduction referred to a major event that would decide the course of our research and have implications for more than twenty years of work.

At the time, experts speculated that these anomalies might be the "memory" of a spiral ramp surrounding the pyramid's exterior, one of the solutions envisaged by certain archaeologists. The load of this ramp would have densified, through compression, the blocks that supported it. This hypothesis was abandoned as too implausible. Only the following mentions were made by Prof. Hui Duong Bui at the Athens Symposium⁶⁹ in September 1988:

*"These zones do not correlate horizontally and may suggest various constructive arrangements (...**spiral constructions**...)"*

and

*"With no simple symmetry other than a certain **spiral appearance**."*

⁶⁸ During a meeting at the EDF Foundation in July 2000 and following the receipt of documents "pulled from the drawers" on the following September 4 and sent by Pierre Delétie.

⁶⁹ See Memoir The BIG VOID page 124 and notes 366 to 371.

STRABO'S PORTCULLIS CHAMBER

Professor Huy Duong Bui clarified the term *"spiral shapet"* some eight years later⁷⁰ at the end of a text on his interest in Khufu's Pyramid and the microgravimetry mission carried out under the aegis of EDF:

"An altogether incredible story is that in 2002, Henri Houdin (Engineer) and his son Jean-Pierre Houdin (architect) proposed a new theory on the construction of the Kheops Pyramid which should involve an internal tunnel spiraling up counterclockwise, exactly as given in our numerical result (1988)!"

The document presented at the first meeting in July was beginning to be relatively precise: the interior spiral ramp with quarter-turn under the pyramid faces had an 8% slope, the section lengths were calculated, the levels of the rotation platforms in the corners were determined, the third in the South-East edge being located at the +43m level. Curiously, while at that time the study was focused solely on the problem of the construction of the volume, the interior layout not yet really being taken into consideration, this +43m level corresponded exactly with that of the floor of the King's Chamber.

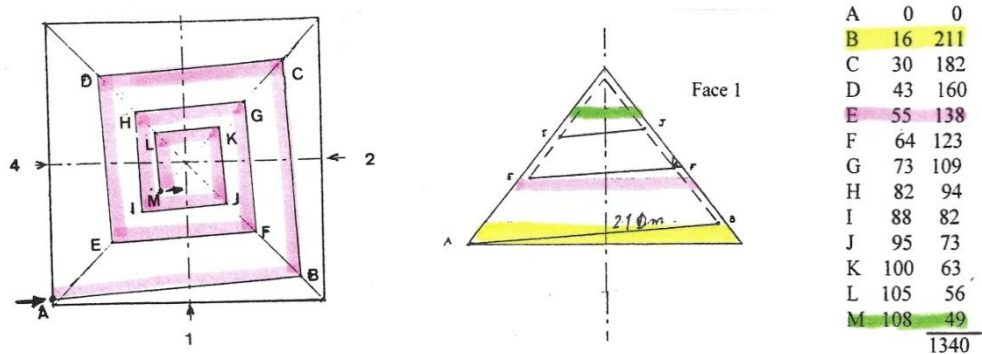

Sketches made by my father in 2000. Face 1 is the East face.

With a slope of 8%, the internal ramp starts in the South-East corner at level 0 (A) and reaches the North-East corner (B) at level +16 m; it continues to the North-West corner (C) at level +30 m and reaches the South-West corner (D) at level +43 m. Section lengths are shown in the right-hand column.

The documents sent by Pierre Delétie on September 4, 2000 are sketches made in 1987 by Jacques Lakshmanan⁷¹ during the analysis of data collected by Prof. Huy Duong Bui. He was quick to express a representation of the spiral pattern associated with the anomalies detected.

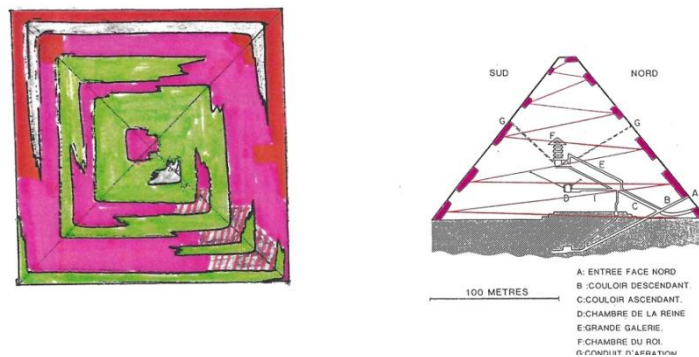

Representation of the spiral shape: it's important to point out that the measurements were taken on the pyramid's edges, and that the anomalies below these edges showed the beginnings of extension on both sides, explaining the "breaks" in the green lines in the central parts joining the anomalies. Fewer measurements were taken on the North-West edge, hence the absence of green in the sketch in this section.

⁷⁰ Text posted on his blog on May 2, 2008 under the title "Kheops Pyramid".

⁷¹ See Le BIG VOID, note 384 on page 129.

STRABO'S PORTCULLIS CHAMBER

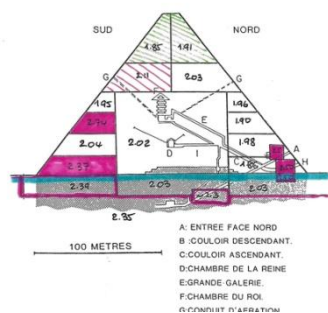

Left: Sketch by Jacques Lakshmanan based on microgravimetry results: a quick transcription of his interpretation of the spiral shape.

On the right, a North-South section showing density differences within the pyramid. Red areas under the North and South faces indicate over-density.

When we received these documents, our attention was totally focused on this spiral anomaly: there was no question of claiming victory, as the scientists who carried out this mission did not provide irrefutable proof of the presence of an internal spiral ramp, but the probability of this "spiral shape" inside the pyramid was a huge and pleasant surprise! This information, obtained thanks to the only mission ever carried out using a non-destructive technique in Khufu's Pyramid⁷², was totally unexpected⁷³.

That said, there was other information in these sketches and density measurements submitted by the EDF Foundation that was also of great importance, as I would discover a little later, as my research progressed.

The unfortunate episode of the original spiral internal ramp had convinced me to start by documenting as much as possible about the knowledge and skills of the Pharaonic builders. So, during the year 2000, I concentrated mainly on finding information about the Khufu pyramid through books, publications and the first websites available at the time. I have to admit that I was extremely surprised by the sheer lack of information on this subject for the uninitiated and therefore left to their own devices.

In this respect, I considered Jean Kérisel's book to be a good source of information on a number of technical points. On the other hand, I had a problem with his bias towards Herodotus' text and a negative interpretation of the reign of Khufu.

As my "discovery" of the pyramid progressed, I admired the "*genius*" of the engineers and architects who had designed and built the monument, but I couldn't understand why there had been any "excess", which turned King Khufu into the tyrannical figure described by Herodotus, based on accounts carried over twenty centuries after the end of the construction work. Once again, I realized that the mere interpretation of a text - Herodotus⁷⁴ in this particular case - could not replace a genuine architectural analysis of the monument, leading to concrete and plausible proposals. As an architect, this injustice done to the authors of the 7th Wonder of the World, added to the astonishing discovery of this "spiral anomaly", led me to the choice I made in the autumn of 2000: to devote myself exclusively to the search for the truth about the construction of Khufu's pyramid.

⁷² The first mission using a non-destructive technique, muography, was carried out in Khafre's pyramid in 1968 by Luis Walter Alvarez, winner of the Nobel Prize for Physics, without success.

⁷³ I'll be coming back to the results of microgravimetry in the forthcoming third Memoir in the trilogy devoted to the discovery of Cavity C1 by ScanPyramids.

⁷⁴ Herodotus' text provides some information, but the lack of plausible construction procedures means that the interpretations made by many are unfounded.

STRABO'S PORTCULLIS CHAMBER

As early as the beginning of 2001, I realized that the architects had designed two construction sites, that of the volume on the one hand, and that of the King's Chamber on the other, integrated into the overall project⁷⁵. Just the sight of a few photos⁷⁶ of the Grand Gallery was enough to convince me that a system of counterweights had circulated inside it. It was at this point that I began to model the pyramid in 3D for the first time, integrating the internal ramp and the interior structures together.

The first consequence was a review of the role of the internal ramp; it became clear that it alone could not have been sufficient to build the pyramid⁷⁷ and that an external ramp was necessary, at least up to a certain level. For reasons of topography and physics laws, this ramp naturally found its place against the South face, opposite the Grand Gallery⁷⁸. This configuration was complementary to the route of the internal ramp under the other three faces: the third section of the latter arrived in the South-West corner at +43 m, level with the floor of the King's Chamber and the arrival step⁷⁹ at the top of the Grand Gallery. The external ramp was ideal for serving the site up to this +43 m level, where almost a third of the volume is already in place, integrating perfectly into the project.

The 3D models below, dating from the end of 2001, were succinct, but gave an overall view of the construction site ramps.

- 1- Rampe extérieure "basse"
- 2- Rampe extérieure "haute"
- 3- Entrée de la rampe intérieure

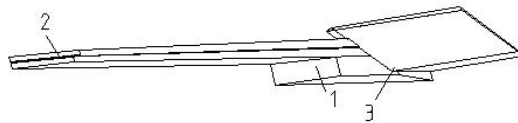

Etat des rampes de la pyramide au niveau +7,06 m

Niveau + 7 m

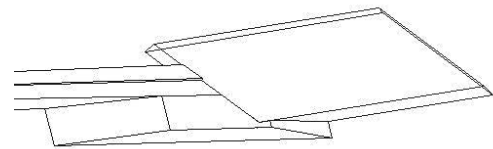

The entrance to the internal ramp is now located at 6th layer, on the +7 m level.

- 1- Rampe extérieure "basse"
- 2- Rampe extérieure "haute"
- 3- Entrée de la rampe intérieure
- 4- Palier en encoche
- 5- Rampe intérieure en galerie

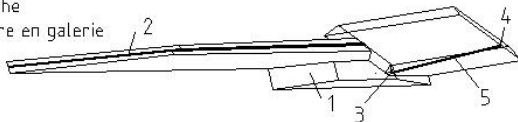

Etat des rampes de la pyramide au niveau +20,83 m

Niveau + 21 m

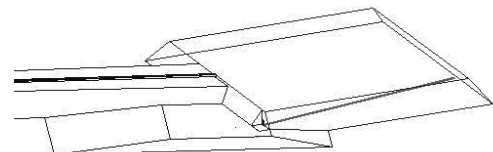

The first bearing for rotating the transport sleds is at level 21 m.

- 1- Rampe extérieure "basse"
- 2- Rampe extérieure "haute", à son niveau maximum
- 3- Entrée de la rampe intérieure
- 4- Palier en encoche
- 5- Rampe intérieure en galerie

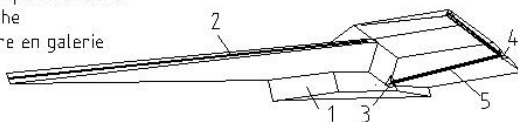

Etat des rampes de la pyramide au niveau +43,11 m

Niveau + 43 m

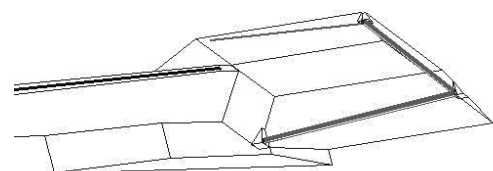

The third level is at +43 m, the second being at +32 m.

⁷⁵ See The BIG VOID Memoir starting on page 9.

⁷⁶ I first saw the pyramids in early October 2004. See Memoir The BIG VOID page 3.

⁷⁷ There were two specific reasons for this: firstly, the size of certain blocks, such as those in the King's Chamber, and secondly, the total number of blocks to be installed. My father was aware of the flow problem when he imagined several ramps on January 8, 1999.

⁷⁸ A counterweight is more efficient when pulling a load which is opposite to its travel.

⁷⁹ Often referred to as the "High platform or Great step" of the Grand Gallery. It also played a major role in the design of the pyramid interior. See Memoir The BIG VOID page 55.

STRABO'S PORTCULLIS CHAMBER

In these first 3D sketches, the internal ramp started at the +7 m level, at the 6th course, to pass over the highest blocks of the first rows; it then developed over some 500 m for a difference in level of 36 m, giving an average slope of 7.2% instead of the 8% of my father's first sketch. Without realizing it⁸⁰, with this configuration and these levels chosen for this slope, I had imagined a slope calculation that could very well have been made by the Egyptians of the time with their system of measurement: an elevation of 1 palm (7.48 cm), for a setback of two cubits (1.04 m), i.e. 7.14%! Another advantage was that the slope was lower.

It was this type of modeling that we presented to Prof. Hany Helal at our meeting on March 21, 2002⁸¹ at the Egyptian Embassy in Paris, and that I represented a few weeks later to Dr. Mahmoud Ismail to discuss a conference at the Egyptian Cultural Centre in Paris. At the end of the interview, Dr. Ismail urged me to redo all my 3D models as color renderings! I spent a summer in front of my computer, relentlessly modeling new images that were much more explicit and attractive, but I'd like to thank him again because he allowed me to enter another world that had extraordinary consequences for the continuation of the Khufu Adventure.

I was finally able to see the pyramid from all angles, and discover the spatial relationships between the chambers, corridors and Grand Gallery.

For the conference at the Egyptian Cultural Center on September 25, 2002, the PowerPoint presentation⁸² of the theory was based on the type of 3D modeling shown below.

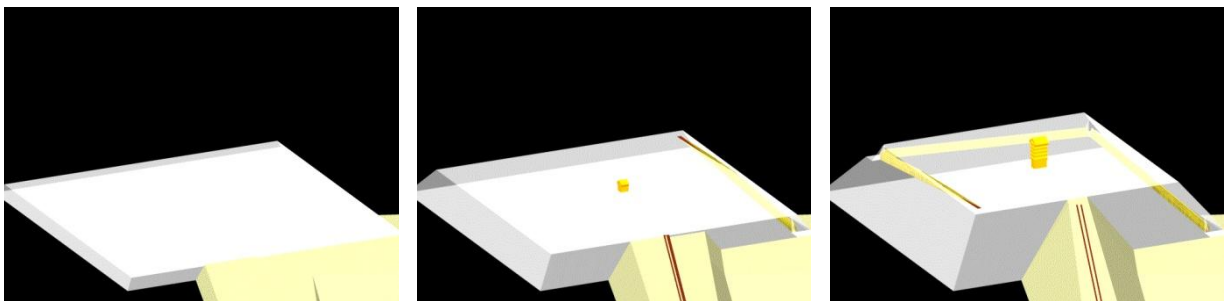

On the left, the +7 m level at the start of the internal ramp, in the middle the +21 m level with the Queen's Chamber in the center, on the right the +43 m level with the King's Chamber. The external ramp arrives at the center of the South face at the same level.

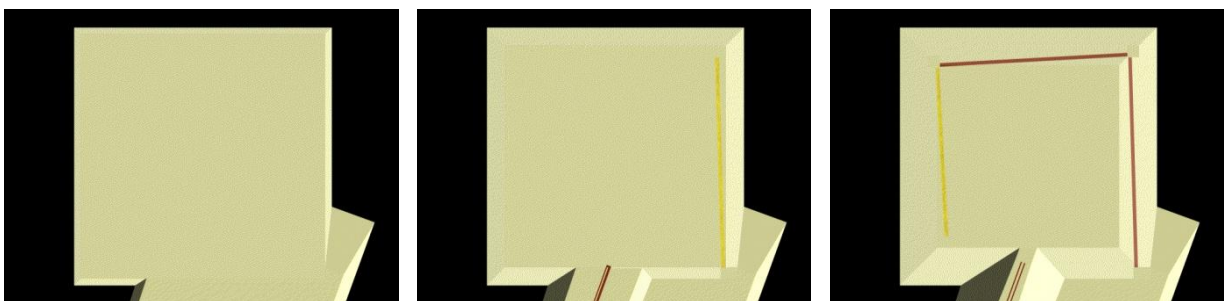

On the left, the +7 m level at the start of the internal ramp, in the middle the +21 m level with the Queen's Chamber in the center, on the right the +43 m level with the King's Chamber. The external ramp arrives at the center of the South face at the same level.

⁸⁰ I hadn't yet fully integrated all the parameters of an Egyptian architect into my thinking.

⁸¹ See Memoir The BIG VOID page 3.

⁸² An improved PowerPoint will be presented at a conference to be held at the Fédération Nationale des Travaux Publiques (FNTP) on December 12, 2002.

STRABO'S PORTCULLIS CHAMBER

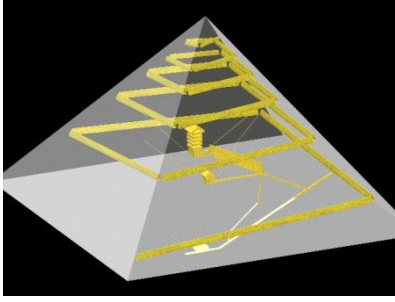

View of the South and East faces.

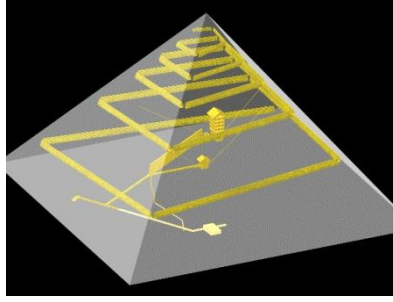

View of the North and West faces.

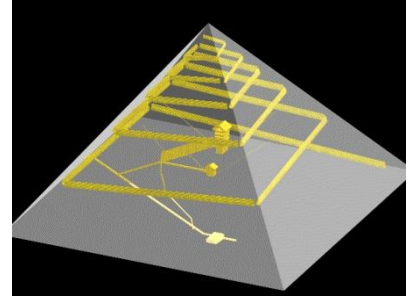

View of the West and South faces.

Despite the lack of precise information concerning certain dimensions of the interior structures, the 3D modeling of the monument already enabled us to better understand their relationship with the development of the internal ramp: the latter, on the periphery, never came into conflict with any of the structures. On the other hand, on the North face, although the two pairs of rafters visible on it were not represented, I sensed that there could possibly be a conflict with the section of the internal ramp between the +21 m and +32 m levels. This was something I wanted to check when I had more data. And, at the end of spring 2003, I received⁸³ the "Grail": Gilles Dormion's plans!

With this series of thirteen recent plans⁸⁴, I finally had an exhaustive survey of all the components of the Khufu pyramid, which would enable me to produce a new 3D model⁸⁵ of the pyramid; I would no longer be interpreting dimensions, I would be transcribing reality.

My immediate interest was in Plan N°5 - ENTRÉE, as I needed to verify certain dimensions in order to develop an idea that was germinating somewhere in my brain; the known interior architecture seemed insufficient, as there were too many grey areas that made a logical understanding of the monument impossible.

The integration of the current architecture of the entrance, with the gaping hole in the North face above the descending corridor, became interesting; a relationship with the internal ramp seemed obvious.

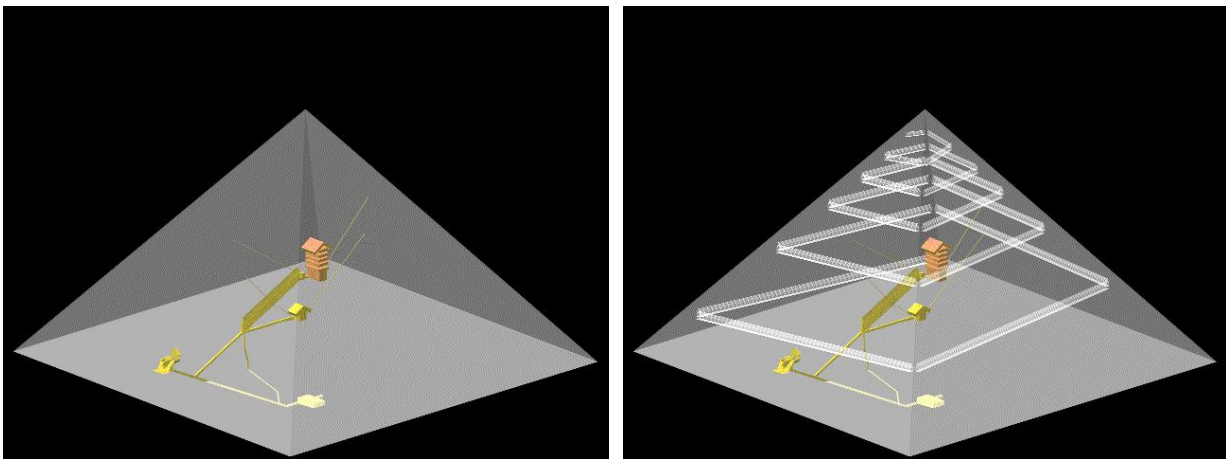

On the left, the two pairs of superimposed rafters are integrated into the pyramid model.
On the right, the internal ramp has been added, and its proximity just above the upper pair of rafters is remarkable.

⁸³ See The BIG VOID Memoir note 416 on page 142.

⁸⁴ Gilles Dormion produced this series of thirteen plans entitled: PYRAMIDE DE CHEOPS - Architecture des Appartements Funéraires. They are dated February 1996.

⁸⁵ Over the past 25 years, more than a dozen 3D models have been produced, first using Autocad 13 software, then from 2006 onwards using CATIA software from Dassault Systèmes, the latest 3D model built in Egyptian cubits.

STRABO'S PORTCULLIS CHAMBER

I wrote on page 14 in the second paragraph under the EDF Foundation sketches:

"That said, there was other information in these sketches and density measurements submitted by the EDF Foundation that was also of great importance..."

I now had the information I needed to carry out this verification.

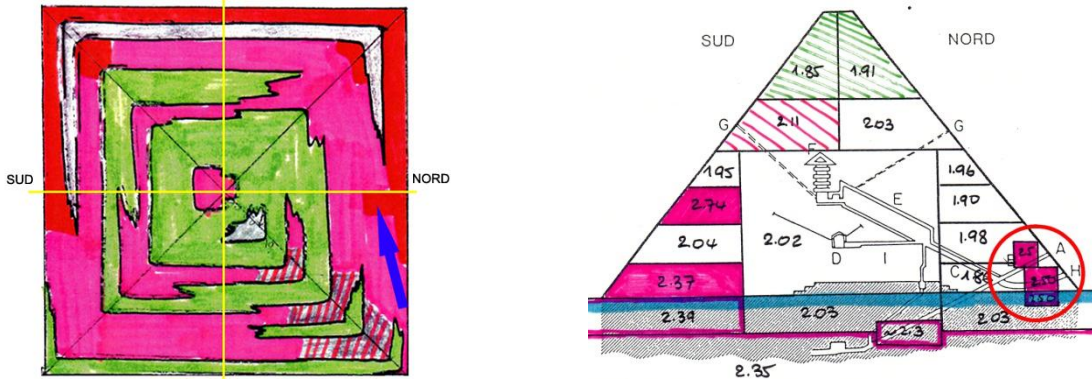

On the left, indicated by the blue arrow, a strong overdensity penetrating several meters into the volume of the pyramid was detected to the East of the North-South axis, in line with the descending and ascending corridors.

On the right, the cross-section shows the vertical position of this 2.5 overdensity corresponding to that of the Turah limestone: above and below the descending corridor, exactly in the area of the entrance to the North face.

One of these pieces of information allowed me to extend the density of the upper pair of Turah limestone rafters above the entrance to the interior of the pyramid by adding a succession of pairs of rafters of the same type to form a roof covering a hypothetical chamber.

A horizontal cross-section⁸⁶ of the pyramid at the +21 m level, the base of the Queen's Chamber and the beginning of the construction of the Grand Gallery, immediately made me realize that the positioning of the pairs of rafters above the entrance on the North face was no accident, but the result of a very precise plan. A room covered by the upper rafters provided a direct link between the Queen's Chamber and the outside via a second horizontal corridor in the North-West corner, with a small room along the way providing the corridor's change of axis.

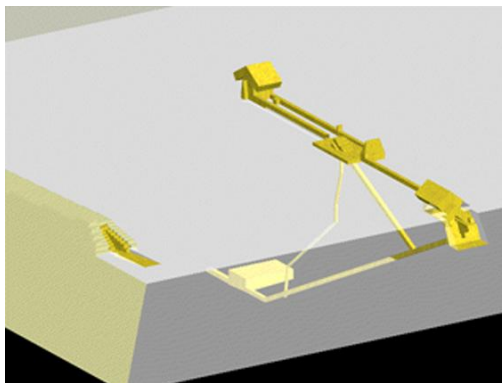

No architect worth his salt would be content to serve the Queen's Chamber only via a route that takes in the descending corridor, the ascending corridor and the known horizontal corridor, when a direct access is easily achievable! When building the horizontal corridor from the North-East corner, the workers would certainly have pointed out to the site manager that a direct parallel corridor also needed to be built from the North-West corner.

⁸⁶ Part of one of the many series of tomographic sections of the monument produced during my architectural studies.

The careful study of all the plans drawn up by Gilles Dormion gave me an enormous qualitative leap forward⁸⁷ for my further work on the pyramid; each plan provided a wealth of precise information, both in terms of dimensions and construction details. It was at this time that I began to respond with a leitmotiv, "*The stones talk*"⁸⁸, when people ask me how I can imagine all these ideas.

Plan N° 5 - ENTRÉE brought me a new piece of information: the presence of stops on either side of the gaping hole and broken rafters base on the East side proved that a second roof⁸⁹ had also been built in front of the pair of low rafters towards the North face. I then imagined that this room was open to the outside and that a "majestic" entrance had been made during construction, which could have been used for the funeral by serving the King's Chamber via another hypothetical ascending corridor⁹⁰.

Plan N°6 - COULOIR DESCENDANT (PARTIE MAÇONNÉE) confirmed my idea that the junction of this corridor with the ascending corridor was problematic in relation to what was said about the funeral procession.

Plans N°7 - COULOIR ASCENDANT and N°8 - COULOIR HORIZONTAL described numerous construction details, some of which betrayed architectural intentions linked, in my mind, to the Grand Gallery.

Plans N°9 - CHAMBRE "DITE DE LA REINE" and N°10 - LA GRANDE GALERIE were veritable open books that told the story of these structures in which each stone, each block, had a precise role.

Plan N°11 – CHAMBRE DES HERSES included a host of highly instructive details calling into question an optimized function of inviolably blocking access to the King's Chamber.

Finally, in Plan N°12 - CHAMBRE "DITE DU ROI" and N°13 - CHAMBRE "DITE DU ROI" CHAMBRES "DE DECHARGE" constructive details on the North and South walls also provided answers that matched my expectations.

To sum up, all these plans were extremely useful in developing a new theory to complement the one I had been proposing until then. They were of course indispensable in defining the counterweight system for the Grand Gallery⁹¹. Almost twenty years later, they were again indispensable in defining the counterweight system in the second Grand Gallery, The BIG VOID⁹².

Before continuing, I'll summarize in the next chapter the key points that led me to develop the theory I dubbed at the time "**Book 2: From the Entrance to the King's Chamber**".

⁸⁷ I'd like to salute Gilles Dormion for the enormous amount of work he put into producing this series of plans; they played a very important part in my research (I'm also associating those of Italian architects Maragioglio & Rinaldi). They are indispensable for anyone wishing to tackle the problem of building Khufu's Pyramid.

⁸⁸ These three words recur frequently in my writings, simply because they're obvious to anyone interested in the language of masonry stones.

⁸⁹ The missing rafters are also sketched on the cross-sections.

⁹⁰ From the moment I imagined a second direct horizontal corridor to the Queen's Chamber, the idea of a second direct corridor to the King's Chamber from the room beneath the rafters became natural and logical.

⁹¹ See The BIG VOID, starting on page 9.

⁹² See The BIG VOID memory, from page 100.

4 - 4 KEY POINTS TO UNDERSTAND THE HISTORY OF KHUFU'S PYRAMID

At the beginning of 2003, after four years devoted to the elaboration of a logical and coherent theory⁹³ concerning the construction of the Great Pyramid, thanks to two distinct but integrated construction sites⁹⁴, the volume site and that of the King's Chamber and its superstructure, an observation had become obvious to me: only part of what had actually been built was known, and pieces of the puzzle were missing to complete the "picture" and finally provide a rational, realistic explanation of the design and construction of the Khufu pyramid.

A detailed analysis of the pyramid's interior showed that certain structures had been built for technical reasons, and that it was inconsistent to attribute a funerary role to them at all costs, particularly in the case of the Grand Gallery.

Over the years, I had only been able to work on the pyramid's dimensions and features on the basis of fragmentary representations and information accumulated in the course of my research. As I wrote in the previous chapter, the discovery of Gilles Dormion's plans⁹⁵ was a major event in my work⁹⁶, at a time when I had never yet seen the pyramids⁹⁷!

Four "key" points called for different answers from those commonly put forward by the Egyptology community, and, curiously, they didn't seem to have any bearing on the history of the Khufu Pyramid in the eyes of the latter; I thought quite the opposite, and explain why below.

Much of the History of this pyramid is impossible to write until a rational explanation is provided for each of the following problematic points:

1. The granite block abandoned in the King's Chamber,
2. Closure of the service well at the bottom of the Grand Gallery,
3. The three granite plugs at the bottom of the ascending corridor,
4. The original entrance to the pyramid.

1 - The granite block abandoned in the King's Chamber.

Until the late 90s, a partly broken granite block was still visible inside the King's Chamber. Its dimensions and the perfect flatness of four of its relatively intact faces were proof that this block originally closed off access to the chamber from the so-called Portcullis Chamber⁹⁸, the latter being in no way optimized for use as a defensive barrier against would-be thieves.

⁹³ And above all, to educate myself by compiling as much information as possible on the Egypt of the 3rd and 4th Dynasties, so as to be totally in tune with the recognized knowledge and constructive know-how available at the time.

⁹⁴ See the PREAMBLE to the first Memoir in the trilogy, entitled The BIG VOID, page 2.

⁹⁵ The plans were given to me by Mr. Jean-Pierre Baron with the agreement of Mr. Gilles Dormion, with whom I was in contact at the time. See The BIG VOID, page 142 note 416.

⁹⁶ I also subsequently obtained, from Professor Peter Der Manuelian, Egyptologist, and Mr Frank Monnier, all the plans drawn up by Maragioglio and Rinaldi concerning the architecture of the Memphite Pyramids.

⁹⁷ I first saw the Great Pyramid on October 6, 2004.

⁹⁸ See The BIG VOID, starting on page 31.

STRABO'S PORTCULLIS CHAMBER

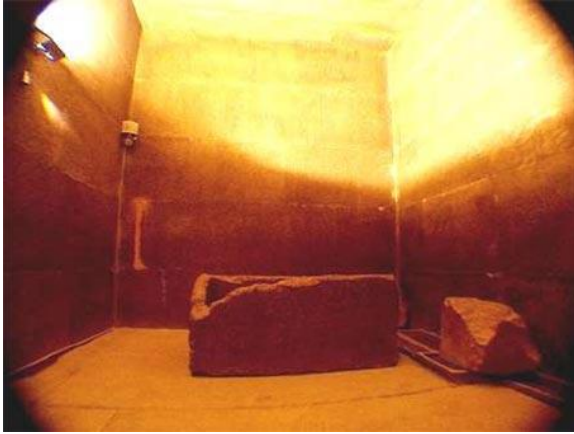

As you can see from the photo, a granite block, partly broken, was left abandoned inside the King's Chamber.



The perfect flatness of two sides of the abandoned block can be seen in this 1998 photo. The block stands on a protective grid covering the digging between the North wall and the sarcophagus.

A close look at the dimensions of the Portcullis Chamber, the passageway leading from the Grand Gallery and the passageway leading to the King's Chamber reveals one thing: the width of the former, 1.03 m, is insufficient (red circle) to allow a granite block (green) to pass through to seal the latter, which is 1.05 m wide⁹⁹. In addition, a 1 cm-high projecting slab (red arrow) blocks the passage under the fixed portcullis, making it impossible to push the block from the Grand Gallery.

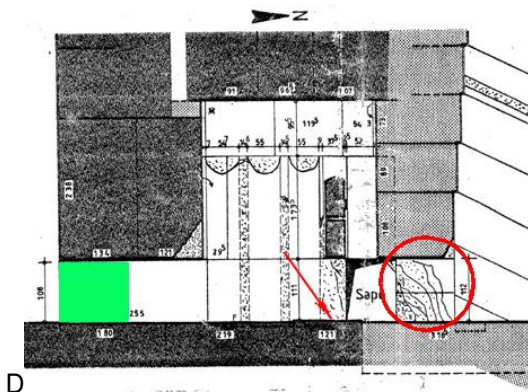

North-South section of the Portcullis Chamber, with the Grand Gallery on the right and the King's Chamber on the left.

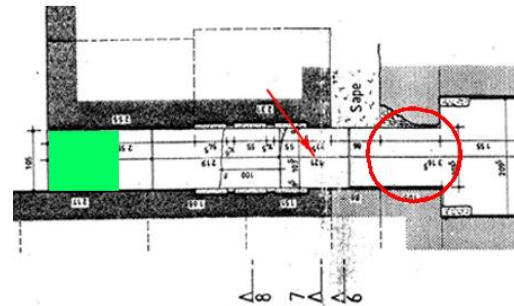

Section and plan by Gilles Dormion

North-South plan of the Portcullis Chamber, with the Grand Gallery on the right and the King's Chamber on the left.

Finally, as the granite block could not be stored in the passageway beneath the three Portcullis, as access to the King's Chamber would become impossible, there was only one possibility left¹⁰⁰: that the block was stored in the room itself, and that the granite slab against which it abuts¹⁰¹ not yet placed in its final position. In this case, the workers responsible for sealing off access to the slab after the funeral would have had no way of getting out, and would therefore have been sacrificed¹⁰². As no evidence has ever been found of such a practice, we can be sure that the Egyptians had planned a normal exit route.

⁹⁹ It's hard to imagine that the Egyptians were content to seal this corridor with a block that was too "small"!

¹⁰⁰ This hypothesis, conceived in 2003, was abandoned following the discovery of the BIG VOID; as I wrote my dissertation interpreting it, a simpler, more logical solution became obvious to me. I'll say more about this in a later chapter.

¹⁰¹ The jump against which it stumbles is 2 cm high.

¹⁰² As suggested in Howard Hawks' 1955 American peplum "Land of the Pharaohs".

STRABO'S PORTCULLIS CHAMBER

The traces of break-in visible on the South walls of the Grand Gallery and the Portcullis Chamber reveal the route taken by the looters to enter the King's Chamber, access to which was sealed by the granite block abandoned there.



The lintel on the South wall of the Grand Gallery was fractured to remove a block sealing the access corridor to the Portcullis Chamber.

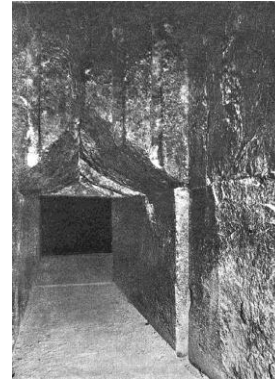

The lintel on the South wall of the Portcullis Chamber has been fractured to gain access to the King's Chamber. At the far end, the 2 cm difference in level between the floor of the corridor and that of the bedroom is visible.

Since the granite block was up against the paving, the looters had no other option but to break the block as much as possible, eventually tipping it into the chamber, where it remained, displaced as events dictated, for almost one thousand two hundred years. Finally, it "disappeared" following renovation work carried out by the Egyptian Antiquities Service. Where is it now? Two scenarios are conceivable: either it has been buried in the trench dug by the sarcophagus's discoverers and then reworked by successive visitors in search of treasure; or it has simply been used as a granite slab to rehabilitate the ground level with the digging.

If the King's Chamber was sealed after the funeral, how did the workmen who sealed it leave the room?

Alternatively, are we sure that this access from the Grand Gallery was indeed sealed after the funeral, or could it not have been closed many years earlier? In either case, there's a piece of the puzzle missing to solve the enigma: somehow getting out of or into the King's Chamber.

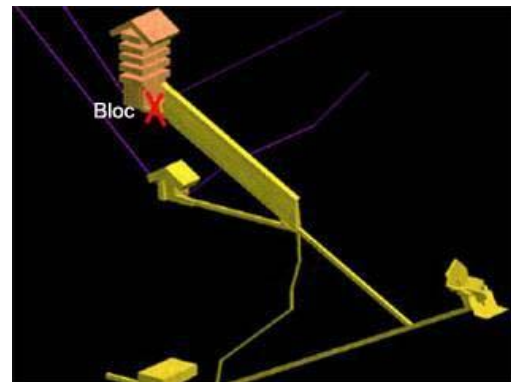
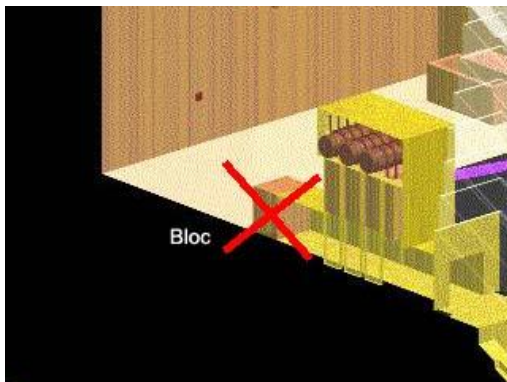

The sealing of the access to the King's Chamber from the Grand Gallery highlights a fact: it cannot be explained rationally, as something is missing to provide a credible solution.

Looking at the pyramid's known interior architecture, and taking into account the problem of installing the block to close the access to the King's Chamber, the first impossibility becomes apparent.

STRABO'S PORTCULLIS CHAMBER

2 - Closure of the service well at the bottom of the Grand Gallery,

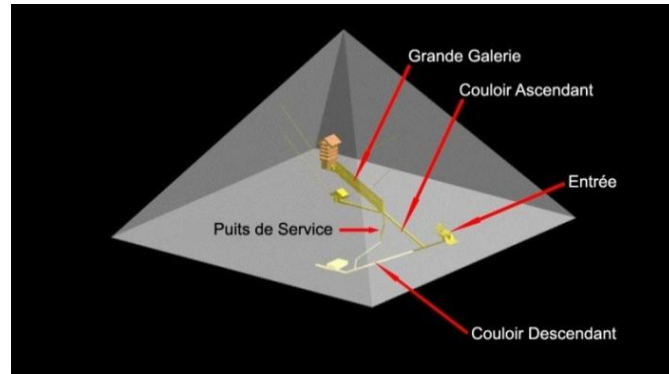

Relationship between the service well, the plug blocks and the workers assigned to launch them

Many "Pyramidologists" seem to agree on the subject of the service well opening into the lower corner on the West side of the Grand Gallery: for them, in addition to its obvious role as a ventilation chimney¹⁰³ necessary during the excavation of the Subterranean Chamber, it was through this passage that the workers who threw the block plugs obstructing the bottom of the ascending corridor would have left the Grand Gallery to reach the outside via the descending corridor¹⁰⁴. A detailed analysis of this well's outlet into the Grand Gallery casts doubt on this last hypothesis.



Views of the current outlet of the service well at the bottom of the Grand Gallery's West bench, near the North wall. The two drawings on the right show that the side bench in the first row consists of a small 13 cm thick vertical block perfectly integrated into the left-hand edge of the well; this detail will be important when the well is reopened.

There's no doubt that the condition of the area around the service well opening proves that it has been reopened from the Grand Gallery. What's more, only the lower block adjacent to the opening on the right-hand side has been largely smashed to pieces, while the two blocks on the left-hand side have been spared. This also proves that the looters must have already reached the Grand Gallery via another route¹⁰⁵ than via the service well.

¹⁰³ The layout, modified during construction to take into account the presence of an unexpected "cave" on the route, shows that the service well would in any case have opened up in the lower North-West corner of the Grand Gallery. This would have been the most appropriate position, given its proximity to the North-South axis, which would have allowed controlling the drilling, row by row, of the well into the Turah limestone blocks of the central socle as the pyramid rose. It was also the shortest route from the bottom of the descending corridor.

¹⁰⁴ Some also claim that it was through the service well that al-Ma'mun's men managed to enter the Great Gallery.

¹⁰⁵ Simply via the ascending corridor, after digging a tunnel alongside the two granite plugs obstructing the lower section.

STRABO'S PORTCULLIS CHAMBER

The following explanation refutes the idea of workers evacuating via this route: at its start, the service well runs vertically below the closing block, then continues horizontally for over a meter¹⁰⁶ before continuing vertically through the core of the pyramid. The last person to leave the Grand Gallery by this route could not properly seal the block obstructing access to the service well, for one simple reason: he would first have had to place a first support block under the closing block, and this sequence would have been impossible.

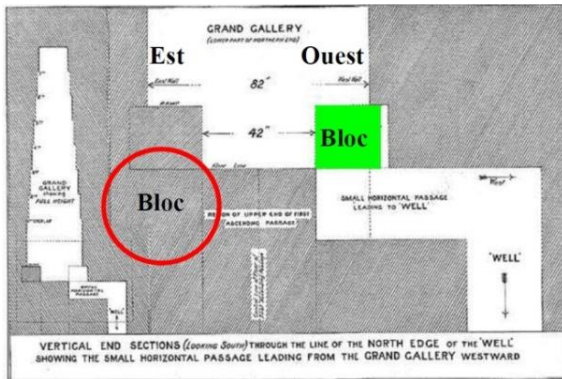

The closing block (green) could not be fitted without a support block underneath, as was the case for the East side bench.

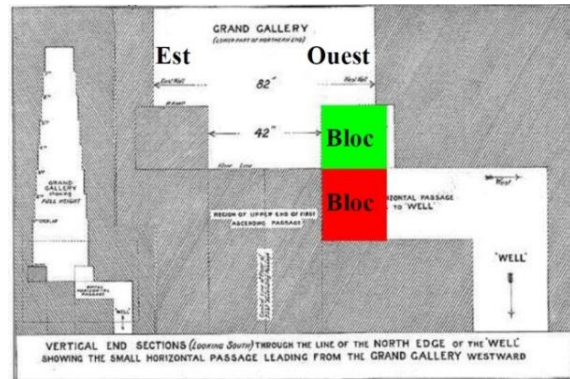

But if you put a support block (red) first, it becomes absolutely impossible to close the passageway correctly with the closing block (green) from the service well.

As the reopening of the service well obviously involved the almost total destruction of the adjoining block on the right, we can deduce that the closing block was perfectly integrated and sealed, and that a possible reopening was not programmed by the designers. Otherwise, knowing the care the Egyptians took with every construction detail, it is reasonable to assume that a less destructive solution would have been implemented to allow easy reopening compatible with a possible closure method from the well.

According to my hypothesis, around the 14th year of the reign, the abandonment of the¹⁰⁷ Subterranean Chamber rendered its ventilation useless. So, before the counterweight¹⁰⁸ was put into service, the opening of the service well into the Grand Gallery was perfectly sealed to enable the counterweight carriage to move properly on the train of rollers running on the side benches.

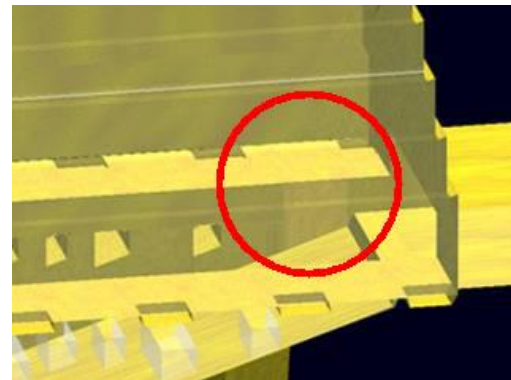
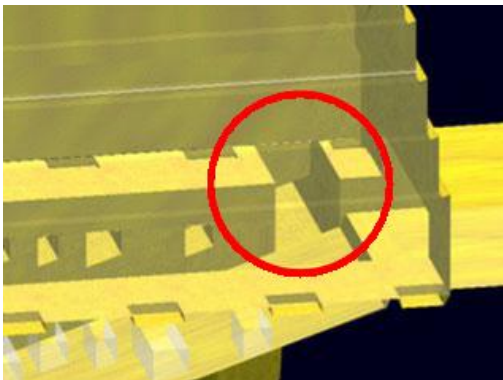

The closing block was perfectly integrated and sealed so that the counterweight carriage could travel unhindered on the side benches of the Grand Gallery, which is why it had been programmed in the first place.

¹⁰⁶ This detail shows that the Grand Gallery was built in a construction trench set aside as the pyramid was constructed, with the well first opening into this trench.

¹⁰⁷ The so-called "Queen's Chamber" was first built a few years ago for the needs of the construction site (see the intercom system described in *The BIG VOID*, pages 74 to 81); it could then have been used as a back-up burial chamber in the event of the King's untimely death.

¹⁰⁸ See *The BIG VOID*, starting on page 9.

STRABO'S PORTCULLIS CHAMBER

During the looting of the pyramid, the presence of this small 13 cm thick block wedged between two rows of blocks on its left and a full-height block on its right must have caught the attention of al-Ma'mun's men, prompting them to go and see¹⁰⁹ what might be behind or beneath the adjoining block. Once the block and its support had been cleared from the Grand Gallery, the men took the service well down to the bottom of the descending corridor. From there, they climbed up the corridor and came up against the rear face of the Turah¹¹⁰ limestone block sealing the true entrance.

The conclusion is clear: the service well was never designed and built to allow workmen to leave the Grand Gallery and reach the outside via the descending corridor.

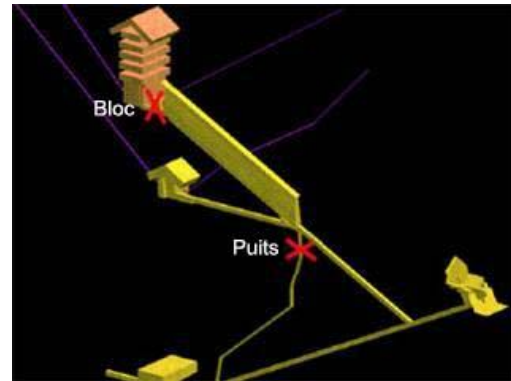
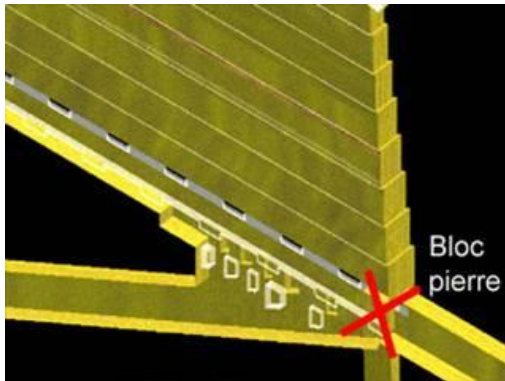

Following the closure of the Subterranean Chamber and the need to maintain adequate ventilation, the service well at the bottom of the West bench of the Grand Gallery was meticulously sealed to allow the counterweight system to be installed. The closing process had not been designed to allow temporary reopening. No exit from the Grand Gallery was now possible via the service well.

3 - The 3 granite plugs at the bottom of the ascending corridor

As they made their way up the descending corridor, the looters discovered the underside of the first granite block thrown into the ascending corridor from the Grand Gallery, ending up just a few centimeters from the ceiling of the descending corridor. Making the connection with the blocks of the same type discovered at the bottom of the ascending corridor during their break-in tunnel, they dug a connecting well between the two corridors.



View, from the descending corridor, of the underside of the first plug block thrown into the ascending corridor.



View of the third plug-block, partly broken, upstream of the second, from the al-Ma'mun's tunnel dug by the looters. A well has been dug linking the two corridors.

¹⁰⁹ After also giving a few picks to these blocks convincing them of the presence of a nearby void, due to resonances or echoes. The same type of information occurred during the breakthrough of the Thieves' Tunnel on the approach to the descending and ascending corridors.

¹¹⁰ From that moment on, they could reopen the corridor leading down to the outside and start demolishing part of the pyramid in this area, another construction detail on the corridor ceiling having aroused their curiosity. More on this later.

STRABO'S PORTCULLIS CHAMBER

The launch of these plug blocks has also been the subject of various speculations, none of which is satisfactory:

For some, the blocks were held in the passage between the Grand Gallery's lateral benches by wooden crosspieces, themselves blocked by wooden wedges inserted into the holes¹¹¹ dug in these benches. After the funeral, workers would release these blocks, which would then slide down to the base of the ascending corridor. This solution encounters at least three major problems: how do you set in motion¹¹² blocks weighing almost five tons laid on a 26.5° sloping pavement? How to "succeed" in getting the blocks into the descending corridor when passing through the void at the junction of the horizontal corridor and the Grand Gallery? How would the workers have evacuated the latter after the launch¹¹³ ?

For others, the blocks would have been freed from the bottom of the ascending corridor: either by workers pulling on ropes from the bottom of this one to free the plug blocks; in this case, part of the ropes would have remained trapped under these blocks, which is not the case. Or by using ropes that would burn until the blocks were released from storage; not only does this seem unrealistic, but these two proposals do not solve the first two problematic points already mentioned

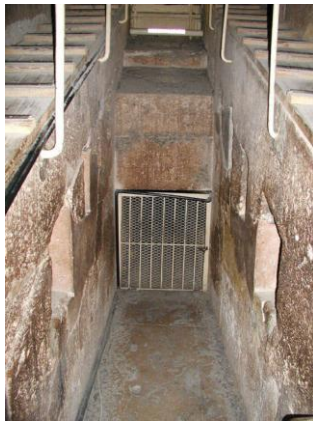

The vacuum at the junction of the ascending corridor with the horizontal corridor and the Grand Gallery was a very delicate point to deal with when launching the plug blocks.

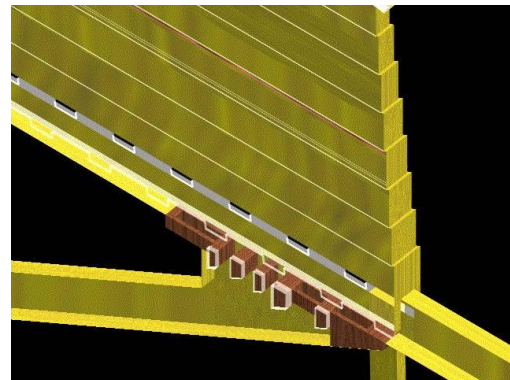
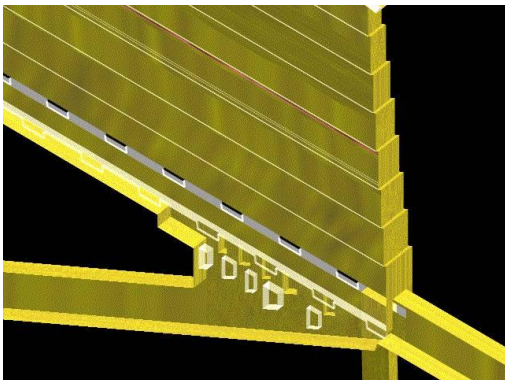

The openings visible in the side walls of this part of the Grand Gallery are undoubtedly linked to the process, based on wooden crosspieces, used to launch the plug blocks.

¹¹¹ There are 28 holes evenly spaced on each side for three plug blocks; it would have made no sense to build a Grand Gallery 48 m long and 8.50 m high to store three granite blocks measuring less than 5 m in total.

¹¹² Because of the "start-up friction", something very high and difficult to treat in this particular case.

¹¹³ Certainly not through the service well, as mentioned above.

STRABO'S PORTCULLIS CHAMBER

So the question is: HOW were the 3 granite plug blocks launched?

After studying the configuration of the lower Grand Gallery, the best course of action would have been to store them as close as possible to the mouth of the ascending corridor, but in this case access to the Grand Gallery by the funeral procession would have been impossible. Here again, the problem of evacuating the workers after the blocks had been launched remains unresolved.

All the proposals have one thing in common: once the King's Chamber is sealed off, with the service well inaccessible and the plug blocks blocking the bottom of the ascending corridor, what about the workers trapped inside the Grand Gallery? There's one more piece of the puzzle missing to complete the picture!

Finally, the question is not only HOW the plug blocks were launched, but also HOW the workers left the Grand Gallery and, above all, WHEN the launch actually took place? AFTER the funeral or... BEFORE?

The idea that the funeral procession would have passed through the descending corridor, the ascending corridor¹¹⁴, the Grand Gallery and the Portcullis Chamber to reach the King's Chamber, becomes materially impossible!

One answer would seem obvious: the above route would have nothing to do with funerary matters, and would be linked to the technical construction process. It would have been "abandoned" at the end of this construction phase, a dedicated funerary route having been planned as part of the project. The King's Chamber would then have a second entrance accessible via another pathway created from the entrance to the pyramid.

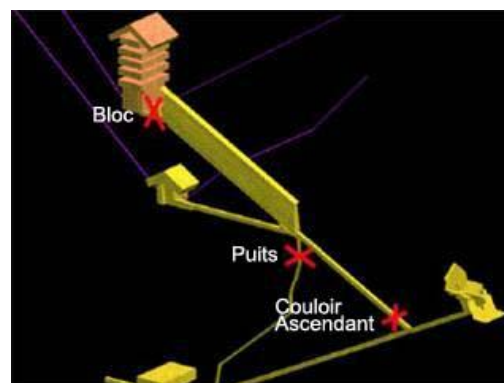
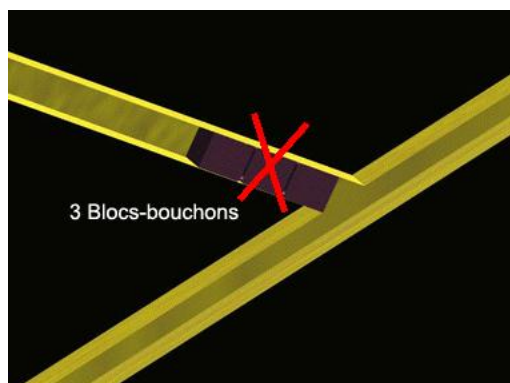

Once the plug blocks are in place at the base of the ascending corridor, the three blockages (red crosses) undermine the suggestion of a funerary procession through the known corridors and the Grand Gallery, before crossing the Portcullis Chamber into the King's Chamber.

4 - The original entrance to the pyramid.

The Egyptology community relies mainly on ancient texts to try and explain the enigmas surrounding the Khufu pyramid. The question of the original entrance is no exception to this rule, with a text by the Greek geographer Strabo¹¹⁵ indicating the following:

"At a certain height on one of its sides is a stone that can be removed, and, once removed, reveals the entrance to a tortuous gallery or syringe, leading to the tomb".

¹¹⁴ Not to mention the transfer of the wooden sarcophagus containing the royal mummy from the descending to the ascending corridor, which is highly problematic; there is nothing on site to suggest that this was possible. Nor should we forget that all the deceased's personal belongings were transported to a dedicated chamber forming part of the funerary apartment. That's a lot of objects, some of them very large, to transport.

¹¹⁵ 1st Century B.C.

STRABO'S PORTCULLIS CHAMBER

The above text is the translation of the original text by the Hellenist Amédée Tardieu¹¹⁶ and is recognized as perhaps the most faithful to the original work. However, other translations have been made, often inspired by Sir Flinders Petrie's reconstruction of a door at the entrance to Khufu's Pyramid. This would be based on a hypothetical door at the entrance to the Bent Pyramid at Dahshur, imagined from a pair of opposing holes in the first blocks of the pyramid's descending corridor.

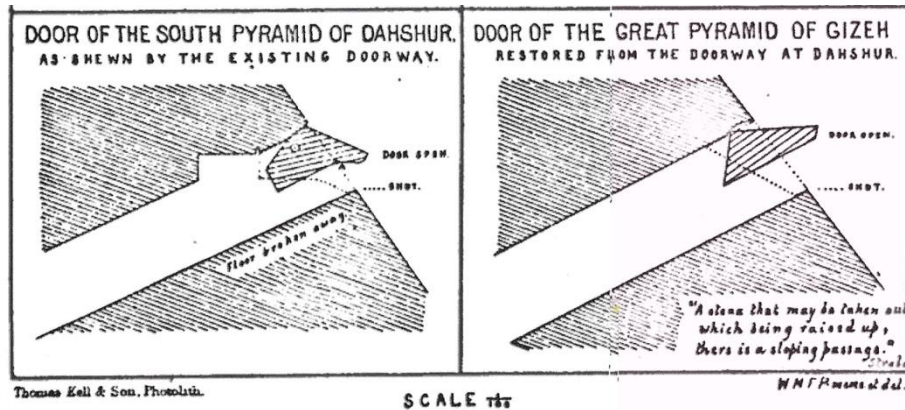

Sir Flinders Petrie's interpretation of Strabo's stone closing the entrance to the tomb in Khufu's Pyramid (right), based on a hypothetical stone closing the entrance to the Bent pyramid at Dahshur (left). Clearly, this proposal is unrealistic, as it does not clear the passageway.

These translations have ended up "polluting" the meaning of this text, as shown by the following examples:

"A stone which can be removed and which, when lifted, gives rise to a sloping passage". Sir Flinders Petrie¹¹⁷.

"The pyramid (has) at a certain height, approximately between its two sides, a stone which can be removed; this, when lifted, gives rise to a sloping passage which leads to the tomb". George Goyon¹¹⁸

The Great Pyramid "has at some height on one of its faces a stone which can be removed and which when lifted gives access to a gallery sloping down to the foundations". I.E.S. Edwards¹¹⁹.

"Around 25 B.C., the Roman geographer¹²⁰ Strabo reported a movable stone, high up and in the middle of one of the faces of Khufu's pyramid, that allowed access to the Descending Passage". Mark Lehner¹²¹.

The latter is so unconvinced that he adds: *"Since any 'trap door' in the original building would have compromised the pyramid's security, this could only have been provided later - perhaps for tourists to reach the subterranean chamber"*.

To return to Strabo's original sentence, it only refers to *"...a stone that can be removed"...* *"...reveals the entrance to a tortuous gallery or syringe"...* *"...leading to the tomb"*.

¹¹⁶ Librarian at the Institut de France, who translated Strabo's "Geographica" between 1867 and 1890.

¹¹⁷ Sir Flinders Petrie - The pyramids and temples of Giza - Page 295

¹¹⁸ The secrets of the builders of the great pyramids, Pygmalion - Pages 302 and 303

¹¹⁹ Les pyramides d'Egypte, Taillandier page 86.

¹²⁰ Errare humanum est.

¹²¹ The Complete Pyramids, Thames and Hudson, Page 39.

STRABO'S PORTCULLIS CHAMBER

Nowhere is there any mention of a "sloping passageway"¹²², "foundations", "moving stone", "raised", "descending corridor", let alone a "trapdoor" and "subterranean chamber"!

The result of these different interpretations, and the confusion that ensues, is that one basic assumption has been established over time: there was a "trap door", now "Strabo's Stone", at the entrance to the descending corridor, and that this was the obligatory passage to the tomb - the King's Chamber - via the ascending corridor, or possibly the Subterranean Chamber.

In Egypt at the time, the term "tomb" did not refer to a single room, but rather to a "funerary apartment" made up of several - at least two - rooms, known today as the "Chamber" and the "Antechamber"¹²³. In an attempt to find coherence with this type of funerary architecture, some have imagined that the Queen's Chamber, or even the Grand Gallery, were part of Khufu's funerary apartment.

It's obvious that the descending corridor led to the outside and that a block of Turah limestone was inserted to seal the pyramid definitively¹²⁴ after Khufu's funeral, and that its size didn't distinguish it from the other blocks on the façade. So I can't imagine that the placement of an ordinary block would have been such a momentous event as to cross twenty-five centuries and eventually reach the ears of Strabo, who gave it historical resonance. This block had to be very special to have remained in the memories of the men who passed on its existence for so long.

The combined impossibilities and inconsistencies concerning the four key points described above make it absolutely impossible to conclude that the descending corridor, ascending corridor, Grand Gallery and Portcullis Chamber were designed as the official passageway for the funerary procession transferring King Khufu's mummy to his Chamber at the heart of the pyramid: it's impossible!

However, it is certain that Khufu's mummy was introduced into the pyramid via the official entrance on the North face, and that it ended its journey in the granite sarcophagus of his Chamber; it is also certain that the priests and other officials emerged alive, the architects having of course planned for this evacuation to be part of their project.

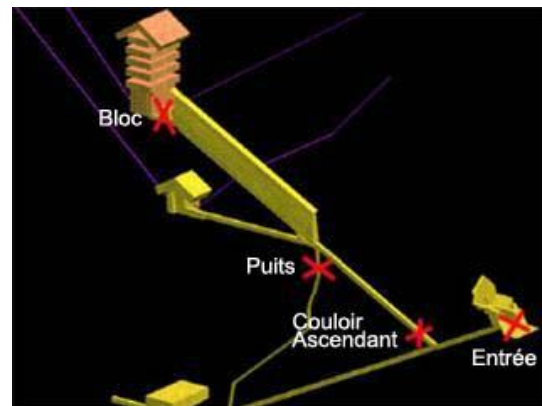

After Khufu's funeral, the Entrance was blocked from the outside, thus blocking access to the King's Chamber at 4 points: The Entrance, the bottom of the ascending corridor, the top of the Service Well and the Portcullis Chamber and the block in the corridor leading to this chamber.

¹²² The direction of the slope being assumed to be "downwards".

¹²³ See the pyramids of Snefru at Dahshur and Meïdum, Khafre and Menkaure at Giza and the numerous mastabas, to name but a few from this era.

¹²⁴ Like all the pyramids cited in note 123 above

Information note N°1 :

Clarification of the last two paragraphs on page 11 reproduced below.

.../...

I wrote above: "... in this first plan drawing, the reasons that will lead to the discovery of the SP-NFC anomaly, which has finally become an "Entrance Chamber" officially part of the pyramid's interior architecture, are already there, unsuspected by anyone".

The reasons for this are to be found in the first and third versions: the internal ramp starts in the South-East corner of the pyramid and spirals upwards in a counter-clockwise direction. The change from a helical to a quarter-turn ramp sealed the fate of the "Entrance Chamber" on the North face!

.../...

From the very first drawing he produced on January 4, 1999, my father Henri positioned the start of the internal ramp in the South face, near the South-East corner, and made it progress through the volume in a circular spiral, counter-clockwise¹²⁶. I was intrigued by the choice of each of these parameters, and a few months later I asked him why he had chosen them. He replied that there were no particular rules, no topographical criteria and that they were not linked to any information provided by the documentary he had seen¹²⁷. He simply told me that when he started to draw his first sketch, these two criteria came naturally, starting the internal ramp in the bottom right-hand corner of the sheet and initiating the movement of the spiral from right to left, continuing it to a height of almost ninety meters! He had no idea of the importance of these parameters later on.

Later I tried to find a plausible reason that might have influenced these choices; I learned that a number of movements, gestures or actions might have something to do with the fact that around 90% of humans are right-handed. Thus, in virtually all dances, dancers turn counter-clockwise because "right-handed people have a greater step amplitude with their right foot (their most developed side), which naturally encourages them to turn left"¹²⁸". Many sports do the same, particularly ice figure skating, in which figures are executed counter-clockwise. I deduced that my father, who is right-handed¹²⁹, was naturally influenced by his more developed side when he started sketching.

So when I proposed breaking the circular spiral, I simply took these parameters and adapted them to the Straight ramp with quarter-turns. With an average slope of 7.14% (one palm per two cubits), four crucial¹³⁰ levels appeared logical: the +7 m level for the start, the +21 m level for the first rotation of the sledges, the +32 m level for the second and the +43 m level, the level of the King's Chamber and the landing of the internal ramp. This inverted U-shaped layout was optimal and perfectly adapted to the topography of the terrain, the nearby quarries and the logistical requirements from these and from the port for delivery of materials from Turah and Aswan.

¹²⁵ The name I later gave to the new corridors I imagined at the time when I revealed them during the presentation of "Khufu Reborn" at the Géode on January 27, 2011 - See Memoir The BIG VOID, page 19, 3D model on the left.

¹²⁶ For the slope of the ramp, he chose 8%, considering that this was acceptable for human traction.

¹²⁷ I recently re-watched this documentary, "The Mystery of the Pyramids", and indeed no particular information is present.

¹²⁸ Why do we dance counterclockwise? George B. Theiss. NTA 2015-5

¹²⁹ Just like me.

¹³⁰ Rounded levels at the time. In the latest version of the CATIA 3D model from 2011, the exact theoretical levels are +7.06 m, +20.32 m, +32.15 m and +42.98 m, for a total length of the 3 sections of the internal ramp of 503 m and a difference in height of 35.92 m.

STRABO'S PORTCULLIS CHAMBER

Throughout the summer of 2003, when Paris was suffocating from a historic heatwave, inflicting me with long bouts of insomnia, and until late autumn, I devoted myself to a series of 3D models in order to materialize my ideas as precisely as possible; the architectural reconstitution of an entrance composed of two successive rooms seemed to me to be the most suitable solution for resolving the four impossibilities described in the previous chapter.

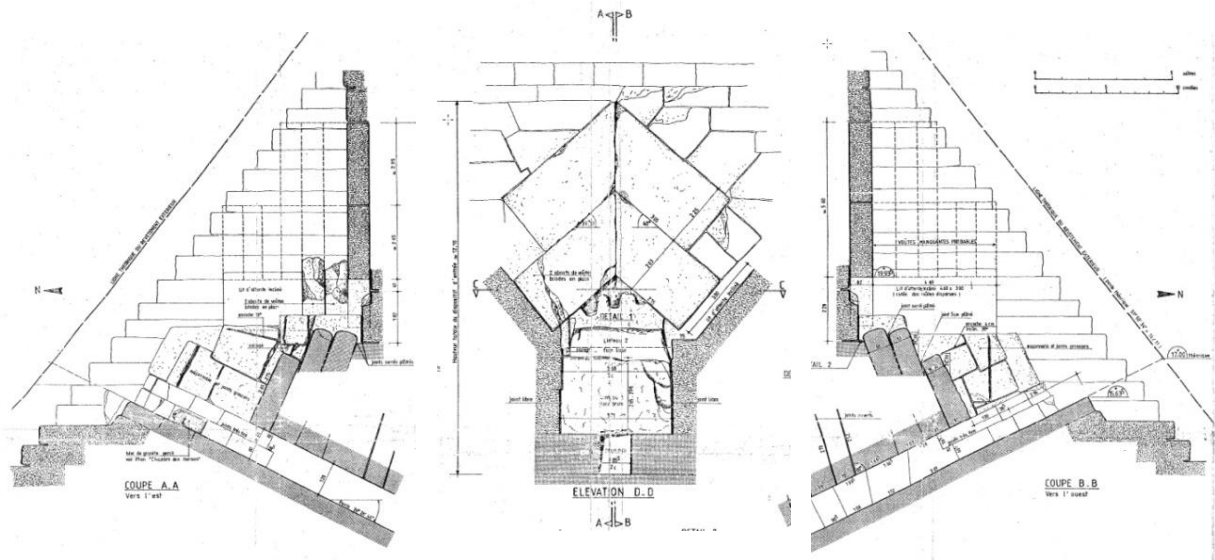

Excerpts from Plan N°5 - ENTRÉE by Gilles Dormion

On the left, a longitudinal section view of the East zone of the gaping hole on the North face above the descending couloir.

In the center, a front cross-section of the structure behind the gaping hole on the North face.

This comprises two pairs of superimposed rafters, a "notched" stone inserted beneath the lower pair, and three large sloping slabs covering the still-existing descending corridor.

On the right, a longitudinal section view of the West zone of the gaping hole on the North face above the descending couloir.

Detailed analysis of these comprehensive documents provides unassailable data: the width between the walls supporting the stops of the first chamber's chevrons roof (now gone, replaced by a gaping hole overhanging the descending corridor) is 3.68 m, or 7 Egyptian cubits. The "Stone"¹³¹ notched inserted under the lower pair, the only remaining part of this roof¹³², has a minimum width of 3.15 m, or 6 cubits. That said, the vertical alignment of the upper rafter stops with those of the lower rafters shows that the roof span of the second chamber is identical to that of the first chamber¹³³. The architects had thus created these two chambers, staggered in height, with the aim of creating a "comfortable" circulation inside volumes with pitched roofs 7 cubits wide at their base: the role of the first was to create a common entrance with the descending corridor as close as possible to its outlet to the outside, and that of the second to bring the second part of this circulation to the level of the floor of the Queen's Chamber, which was then only some eighty meters away.

¹³¹ Strabo's Stone will be amply described in a later chapter.

¹³² The side walls of the gaping hole feature support "stops" for several roof rafters; two broken rafter "feet" are still in place in the East wall.

¹³³ The span of the roofs proves that these two successive structures are to be classified as "chambers" in Egyptian architecture and not as "corridors".

STRABO'S PORTCULLIS CHAMBER

In earlier pyramids, such spans were covered by load-bearing vaults, commonly known as corbelled vaults. On the basis of a span of 7 cubits, and corbels of 2 palms (i.e. 15 cm) on either side of the void, eleven corbels would have been necessary. Imagining these corbels starting from the floor level¹³⁴ of each of the two chambers, the vaults created would each have been over 8 m high, too high given the proximity of the North face. What's more, in the case of the second chamber, which starts at a higher level than the first¹³⁵, the problem would have been magnified, as the corbelled vault would have formed a veritable vertical wall of great height on the North-South axis between the North face and the Queen's Chamber. At this precise point in the pyramid's volume, this roofing technique would have come into direct conflict with the process imagined for the construction of the pyramid's volume; it was discarded in favor of a new technique that was to be implemented for the first time with the construction of Khufu's pyramid.

The architects opted for a type of vaulting that could be described as "lowered", as it drastically reduced the height required to cover a void of up to 10 cubits, or 5.24 m, a span programmed into the project by the architects. The vault, made of Turah limestone beams forming chevrons, also known as a chevrons roof, was intended to cover the Queen's Chamber and the King's Chamber. The two successive entrance chambers, with roofs staggered to fit into the volume while following the slope of the nearby North face, inaugurated this new technique by being covered by chevrons roofs.

In Chapter 3 - - 1999 - 2003: FIVE FOUNDING YEARS, I ended with the 3D model below:

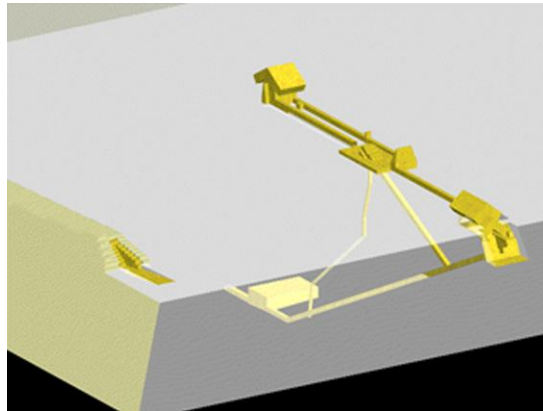

In this 3D model, based on Gilles Dormion's Plan N°5 -ENTREE and the Fondation EDF sketches shown at the top of page 18, I imagined that the first chamber above the descending corridor was "open" to the outside for the duration of construction, this idea being influenced by the currently existing gaping hole and by the fact that I had never yet seen the pyramid with my own eyes. So I had no real perception of the void at the mouth of the descending corridor. This idea of a provisional opening in the first chamber was to last for many years, notably when I later imagined a provisional staircase and masonry platform for King Khufu's funeral.

The "peculiarity" of a Stone had enabled it to survive more than 25 Centuries before Strabo became aware of it and wrote about it in his text on the pyramid. I therefore imagined that this Stone was visible and must have left a lasting impression when it was placed in front of a huge crowd during the funeral procession.

With all this information in hand, I was able to carry out extensive 3D tomographic modeling of the area between the +21 m and +32 m levels, in order to visualize the advancement of the internal ramp section between the sled rotation zones in the North-East and North-West corners, and its interaction with the chevrons roofing of the second entrance chamber I had imagined.

¹³⁴ This was not feasible anyway, as the corbelling could only start above a horizontal level based on the highest level of the corridor leading down into the first bedroom.

¹³⁵ To follow the height difference between the two rooms.

STRABO'S PORTCULLIS CHAMBER

The 3D illustrations below are part of the very first model produced in summer 2003.

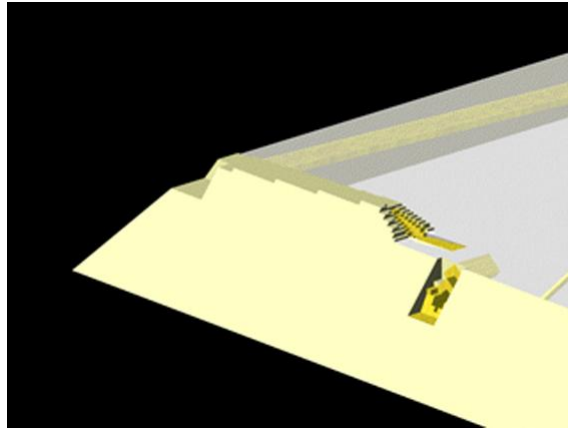

View of the progress of the second section of the internal ramp as it approaches the second entrance chamber on the North face.

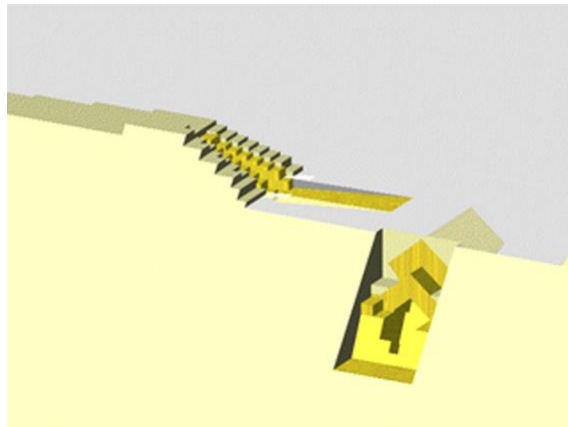

Close-up view showing the proximity between the floor of the internal ramp and the ridge of the second entrance chamber's chevrons roof. Clearly, a corbelled roof, at least 8 m high, on the second entrance chamber would have "blocked the way" for the internal ramp. Furthermore, this rafters vault supporting only a relatively small load, given its proximity to the North face, could be structurally compared to a vault resting on lateral abutments which would support the deck of a bridge.

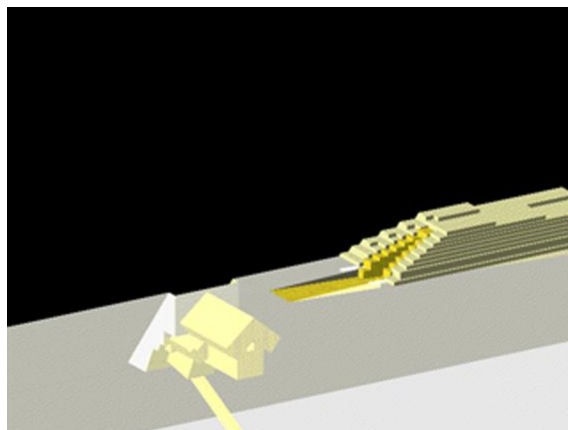

Close-up view showing the proximity of the internal ramp floor to the ridge of the rafters roof of the second entrance chamber. The design of the area around the entrance and the second section of the internal ramp, between the first rotation room under the North-East edge at the +21 m level and the second rotation room under the North-West edge at the +32 m level, was certainly part of one of the most geometrically advanced studies of the entire pyramid project. This area was crucial, as it brought together the interior works, the entrance to the pyramid, and the volume works. Finally, its neuralgic position was linked to the multiple uses of this double-chambered structure.

STRABO'S PORTCULLIS CHAMBER

2003 reconstruction of the interior architecture of the two entrance chambers, compared with the current condition of the area above the entrance to the descending corridor.

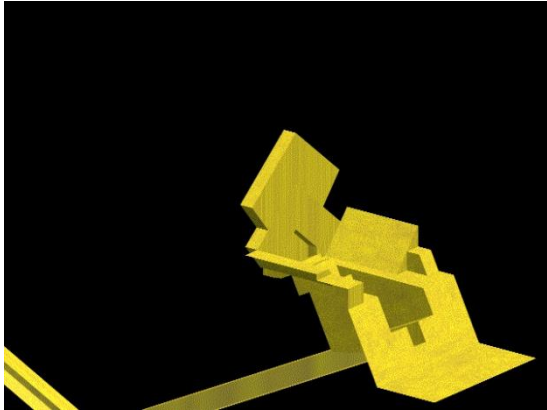

3D modeling of the current appearance of the entrance area to the descending corridor and the double pair of rafters.

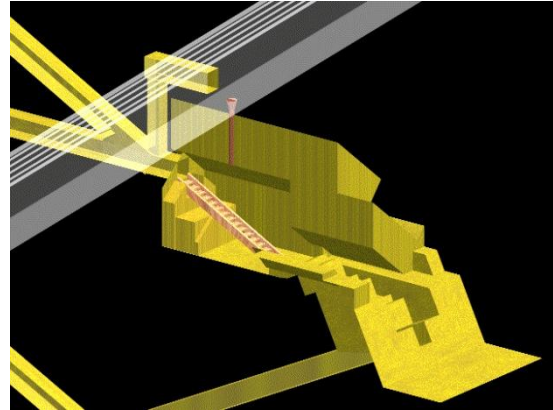

3D modeling of the two entrance chambers with reconstruction of the rafter roofs.
A detail in the second chamber shows that at the time I was wondering about a technical possibility.

The second chamber provides a second direct horizontal corridor to the Queen's Chamber and a second direct ascending corridor to the King's Chamber. The architecture of the interaction between these two corridors is similar to that of the horizontal corridor known from the Grand Gallery. A well, running vertically from the junction of the corridors behind the back wall of the second chamber, provides access to the second section of the internal ramp, which intersects just above. The width of the second chamber allows the "Strabo Stone" to be stored at the back of the room. This stone played a key role in the construction of the first entrance chamber, and was used to seal off access to the "Noble Circuit" after King Khufu's funeral. A temporary wooden staircase provided access to the corridors throughout the pyramid's construction.

A model dug into the bedrock some 50 meters to the East of the pyramid provides a partial representation of all known corridors and junctions inside the monument. However, part of it is also representative of the start of the "Noble Circuit" behind the second chamber. Curiously, the vertical well pictured does not exist in the known circulations, but fits perfectly above the junction of the second horizontal corridor and the second ascending corridor. The access well to the internal ramp therefore appears to be represented here.

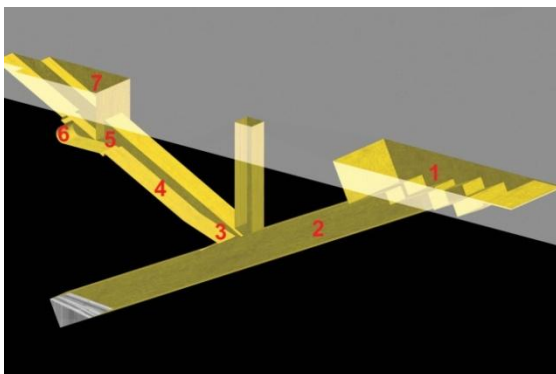

Known corridors and junctions :

- 1 - Descending corridor leading to the outside
- 2 - Descending corridor
- 3 - Descending corridor/Ascending corridor junction
- 4 - Ascending corridor
- 5 - Ascending corridor/horizontal corridor/Grand Gallery junction
- 6 - Horizontal corridor
- 7 - Grand Gallery

Unknown corridors and junctions :

- 4 - Second ascending corridor
- 6 - Second horizontal corridor
- 5 - Second ascending corridor/second horizontal corridor junction

The vertical well represents a model of a well above a junction that only serves a purpose in the "Noble Circuit": to allow access to the internal ramp crossing just above the second entrance chamber, so that the last workers sealing the pyramid can safely leave the building.

By creating new corridors from the rear of it to serve the Queen's and King's Chambers, the interior architecture once again became simple and logical, with direct circulation available throughout the construction period and right up to the funeral. Without these, access via the corridor leading down to

STRABO'S PORTCULLIS CHAMBER

these two chambers was neutralized by the use of a counterweight¹³⁶ in the Grand Gallery for several years.

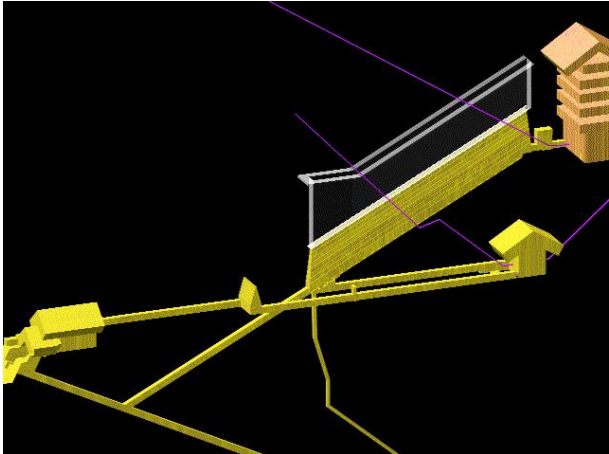

The construction of a second horizontal corridor, starting at the end of the second entrance chamber, allows direct access to the Queen's Chamber from the outside. In this 2003 model, a small, corbelled, covered room allowed the corridor to be re-axed.

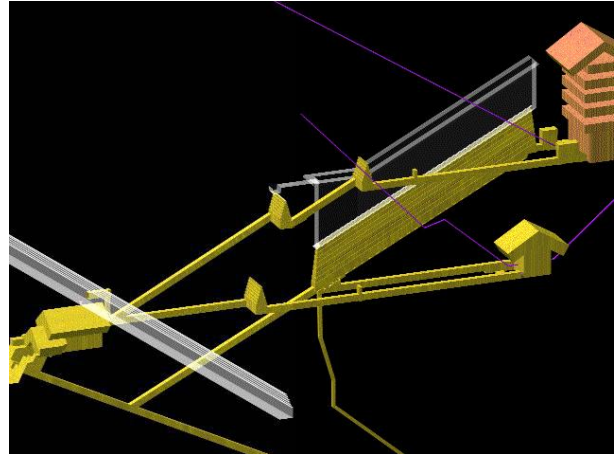

The construction of a second ascending corridor, starting at the end of the second entrance chamber, enabled the King's Chamber to be reached directly from the outside. In this 2003 model, two small rooms with corbelled roofs allowed the corridor to be re-axed. The well created above the junction of the departures of the two new corridors allowed access to the internal ramp to leave the pyramid after sealing the Noble Circuit.

The Noble entrance to the Queen's Chamber in the Western part of the North wall.

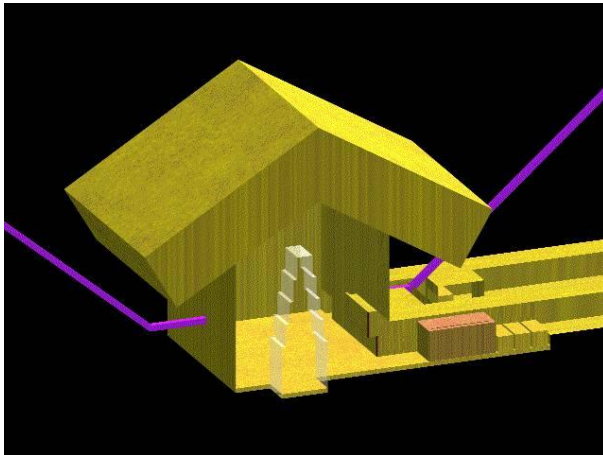

During much of the construction of the King's Chamber, access to the Queen's Chamber via the known horizontal corridor was impossible due to the use of a counterweight in the Grand Gallery.

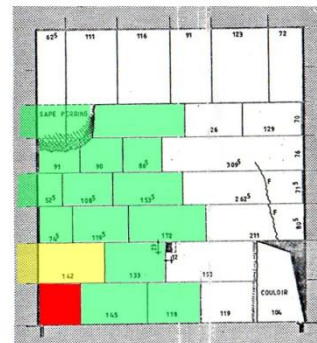

ELEVATION NORD

Based on a Gilles Dormion plan

The red block closes the Noble entrance to the Queen's Chamber. The yellow block just above it is a lintel that takes up the load of a few green blocks, the latter not supporting any roof load.

Note: The North wall features other highly instructive construction details relating to the temporary use of the Queen's Chamber as an intercom system during the use of the counterweights in the Grand Gallery and the BIG VOID¹³⁷.

¹³⁶ The ascending corridor was unusable for accessing the Grand Gallery due to the roller-train's roller-lest tension. See Memoir The BIG VOID page 13.

¹³⁷ See Memoir The BIG VOID, from Information Note N°5, page 74 to page 81.

STRABO'S PORTCULLIS CHAMBER

The Noble entrance to the King's Chamber in the Western part of the North wall.

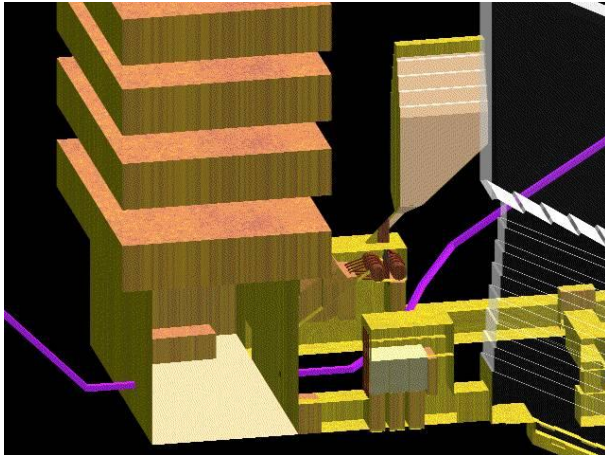

As soon as construction of the King's Chamber began, access via the known ascending corridor became impossible due to the use of a counterweight in the Grand Gallery. Until the King's funeral, only access via the Noble Circuit was possible. A new detail in the second entry shows that at the time I was wondering about a technical possibility.



Based on a Gilles Dormion plan

The blue block closes the Noble entrance to the King's Chamber. The 1st yellow block located just above this block is a lintel that takes the load of 2 other yellow blocks. The red blocks form a portico that takes half the load of the only beams in the structure above the King's Chamber. The rafter alone carries the load of the pyramid above it. Note: The yellow lintel block is cracked, and looters have dug a hole in line with the blue block in search of treasure, even though there are 32 linear meters of wall in the room. One detail must have caught their attention.

The 3D models below, produced during this period, show the interaction between the two entrance chambers and the second section of the internal ramp; they highlight the incredible mastery of geometry by the Great Pyramid's architects, Hemiunu and Ankh-haf!

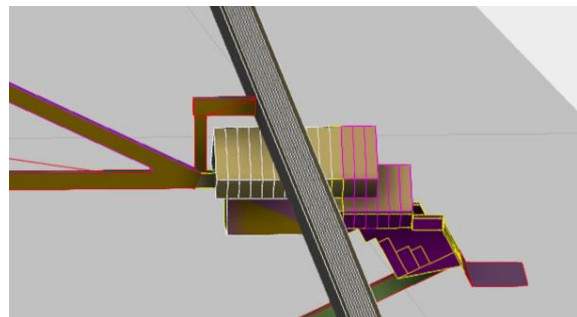
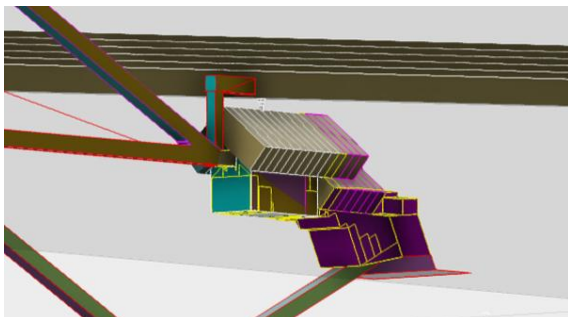
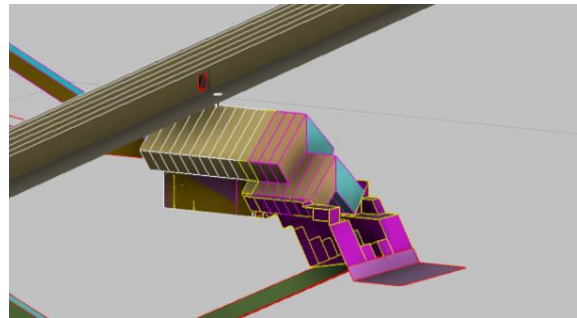
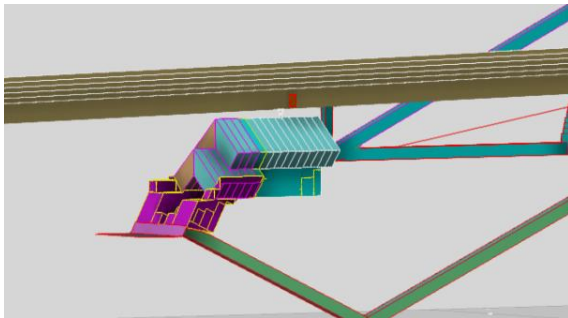

STRABO'S PORTCULLIS CHAMBER

The sentence from Strabo that I quoted on page 27:

"At a certain height on one of its sides is a stone that can be removed, and, once removed, reveals the entrance to a tortuous gallery or syringe, leading to the tomb",

The second entrance chamber had been used to store the "Strabo Stone" until Khufu's funeral. Once the funeral procession was over, the priests and other officials exited the pyramid via the Noble Circuit they had taken on the outward journey. Only a small team of workers remained inside to "push" the Strabo Stone to its present location beneath the lower pair of rafters, building an additional wall above it to definitively seal off access to the second chamber. They then left the second chamber via the vertical well at the junction of the corridors to reach the internal ramp and leave the pyramid at its base. Meanwhile, another team of workers sealed the access to the known descending corridor and the first entrance chamber from the outside, with the Turah blocks being laid last. The temporary scaffolding providing access to the pyramid entrance was then dismantled, with the last blocks of the white limestone mantle blending into the façade¹³⁸.

The story of the "Strabo Stone" began.

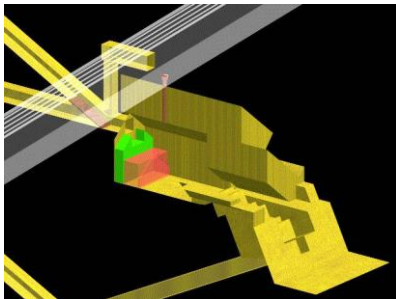

The "Strabo Stone", in red, and the complementary masonry, in green, are stored at the rear of the second chamber, awaiting burial.

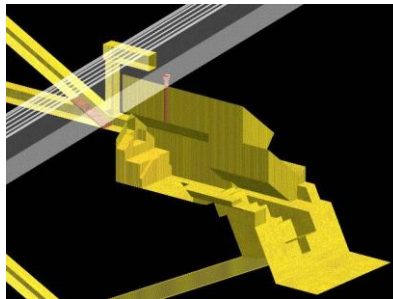

The funeral is over, and the last workers assigned to setting up the Strabo Stone remain in the second chamber.

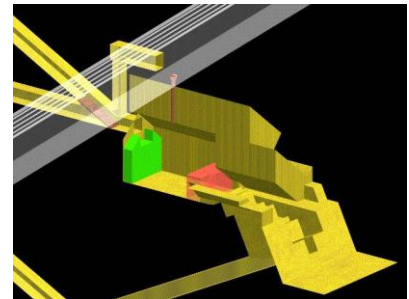

Workers push the Strabo Stone into its final position, under the lower pair of rafters, before building a wall on top of it.

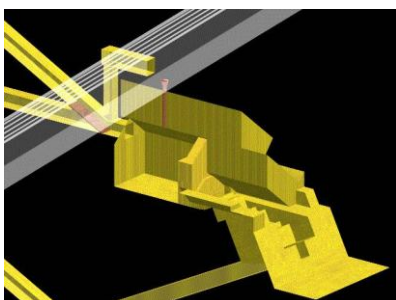

The passage between the first and second chambers is sealed, and the workers in the second chamber reach the internal ramp via the vertical well.

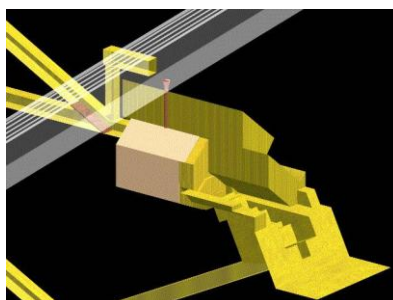

A hypothesis considered at the time, which I explain in the following Information Note N°2: to prevent the Strabo Stone from being pushed back, sand would have been poured into the second chamber.

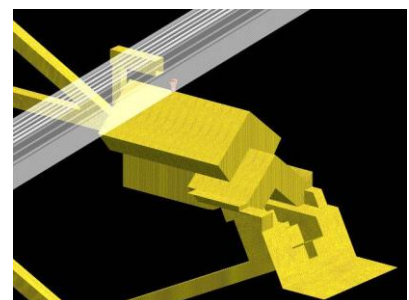

Aspect of the two entrance chambers after the funeral before the final finishing work masking the entrance to the pyramid.

¹³⁸ The same applies to the entrance to the internal ramp in the South-East corner of the South face.

Information note N°2 :

At the top of Page 32, in the caption to the drawing on the right, I wrote: "A detail in the second room shows that at the time I was wondering about a technical possibility".

And I repeated at the top of Page 36 in the drawing on the left: "A new detail in the second entry shows that at the time I was wondering about a technical possibility".

In the first, the detail is the "gutter" inserted into the chevrons roof, in the second, it's the presence of a small corbelled chamber filled with sand located just above a closing device by a granite "portcullis" block designed to seal the second entrance to the King's Chamber. This idea of the use of sand for a particular function in the pyramid had occurred to me while studying extracts from documents concerning the microgravimetry mission carried out in 1986/87¹³⁹ under the aegis of the EDF Foundation¹⁴⁰ handed over by Pierre Delétie.

During this mission, three boreholes spaced at around 1.50m intervals were drilled from the West wall of the horizontal corridor at a downward angle of around 30 degrees.

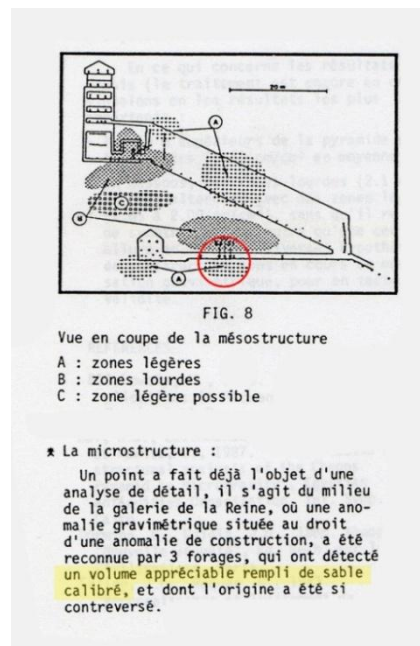
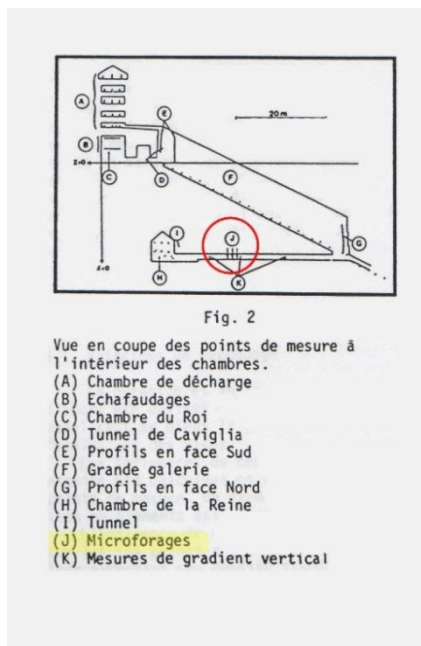

Extracts from part of the¹⁴¹ documents handed over to us by Pierre Delétie in September 2000.

The phrase "an appreciable volume filled with calibrated sand" made an immediate impression on me. It also said "whose origin has been so controversial". So I took an interest in this sand to find out more.

In their book "Les Nouveaux Mystères de la Grande Pyramide", authors Gilles Dormion and Jean-Patrice Goidin¹⁴² write:

"Two and a half meters. Drilling revealed several blocks of stone separated by mortar. Shot to 40°, the second hole will confirm. The third, at a depth of 2.65 m will end in an astonishingly fine sand".

¹³⁹ 1st campaign in May 1986, 2nd in August 1986, 3rd in February 1987 and last in November 1987.

¹⁴⁰ See pages 12, 13, 14 and 18 of this document and The BIG VOID Memoir page 50, note 267; page 53, note 274; page 124 and notes 366 to 371 and sketch legend page 125 and note 372.

¹⁴¹ The Engineering Geology of Ancient Works, Monuments and Historical Sites - Preservation and Protection. Extracts from proceedings edited by A.A. Balkema / Rotterdam / Brookfield - 1988.

¹⁴² Les Nouveaux Mystères de la Grande Pyramide, Albin Michel 1987, page 197. The authors were initiators and participants in the 1986/87 microgravimetry mission.

STRABO'S PORTCULLIS CHAMBER

In an article¹⁴³ published in May 1987, it is specified with regard to drilling:

"The main results can be summarized as follows:

- discovery of a first block of very hard limestone about 2 cubits long (2 x 53 cm wide),
- beyond that, 1 or 2 cubit-wide blocks of softer limestone, with joints that are generally very tight,
- Microdrillings 1 and 3 revealed mortar on these blocks, before emerging into the sand,
- evidence of a significant sand layer; in all 3 boreholes, sand was encountered in varying thicknesses: 10 cm at S2, 20 cm at S1, 40 cm at S3¹⁴⁴,
- Beyond the sand, limestone masonry was found on S1 and S2. For S3, the 30 cm unit length of the rods did not allow us to go beyond a total length of 2.55 m".

The following article in the same publication¹⁴⁵ mentions the "sand" in the Queen's Chamber corridor:

"This sand encountered in drilling is a quartz-dominated sand with a very good classification. Microscopic examination shows that it has a definite eolian origin, but recent deposits and concretions on the grains have not yet made it possible to determine whether these grains also show secondary fluvial wear".

Eventually, I learned¹⁴⁶ that this sand was not of local origin, but came from the Sinai¹⁴⁷, its origin having been determined after an in-depth analysis highlighting its very particular properties: it was a dry sand solely of wind origin, composed mainly of quartz from the disintegration of hard rocks found in this desert, with great fluidity, thanks to the fineness of its granulometry and the absence of asperities.

I drew the following conclusions:

- If, as in the case of granite (and to a lesser extent Turah limestone), the Egyptians didn't hesitate to fetch a particular sand hundreds of kilometers from the site because of its properties, it's because they had a specific use for it; they could use it to move heavy blocks into place and/or to "fill" cavities (corridors, chambers or other) to reinforce defensive barriers against thieves or protect certain areas.

At the time, I had envisaged, among various possibilities, that the second entrance chamber¹⁴⁸ could be filled with this type of sand, microgravimetry indicating only an overdensity linked to the Turah limestone rafters. As with the "hourglass" principle, a high reservoir was needed to store the sand before it could be poured: the internal ramp plus the "gutter" and the small corbelled chamber served this purpose. Curiously, microgravimetry for the latter also indicated a "light zone"¹⁴⁹ in the area.

¹⁴³ Micro-drilling in Khufu's Pyramid by Yves Lemoine, Annales de l'Institut Technique du Bâtiment et des TP, N 454, May 1987, page 124.

¹⁴⁴ Drilling S3 is in the center, between S2 on the Queen's Chamber side, and S1 on the entrance side.

¹⁴⁵ Observations Géomécaniques de la Pyramide de Khufu by Pierre Delétie, Annales de l'Institut Technique du Bâtiment et des TP, N 454, May 1987, page 126.

¹⁴⁶ By Pierre Delétie, mission geologist, himself.

¹⁴⁷ Several hundred kilometers from the Giza Plateau

¹⁴⁸ Which is on the same level and some fifty meters from the sand "pockets" discovered.

¹⁴⁹ See the document on the left with Fig. 8 and the enlargement on the right on the next page.

STRABO'S PORTCULLIS CHAMBER

There was still one point to be clarified in relation to the funerary architecture inherited from the 3rd Dynasty at the start of the 4th: the¹⁵⁰ pyramids built by Snefru, the father of Khufu, feature "funerary apartments" consisting of a chamber and one or two adjoining antechambers. The plan of the interior structures known from Khufu's Pyramid is a complete break with this architecture¹⁵¹, but once the existence of a "Noble Circuit" became a strong possibility, it could also serve one or two antechambers in keeping with tradition.

The question now was: were there other structures at the heart of the Pyramid?

Working for more than two years on the¹⁵² counterweight system used to build the¹⁵³ superstructure above the King's Chamber, I was not at all convinced that it discharged anything to the King's Chamber. Rather, I imagined that the limestone rafter beams of the roof, supported by inclined lateral stops, transferred the load above the roof obliquely into the mass of the pyramid on either side, without contact with the superstructure below. The latter would have been designed to raise the roof by some twenty meters¹⁵⁴ to protect "something" from the transfer of this load, like an umbrella. Given the known interior architecture and the Noble Circuit, this "something" could be in the Northern part of the pyramid. The deviated courses of the¹⁵⁵ North shafts in the Queen's Chamber and King's Chamber also seemed to indicate the presence of "something" to be avoided, unlike those on the South side, which were perfectly straight and superimposed.

Last but not least, the information that struck me as most remarkable was right in the middle of the document on the left, Fig. 8, enlarged in the image on the right: a light, large area to the West of the Grand Gallery, close to it.

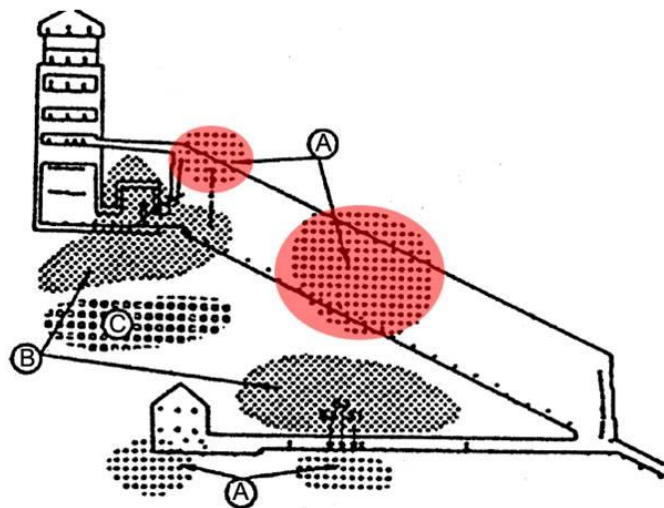
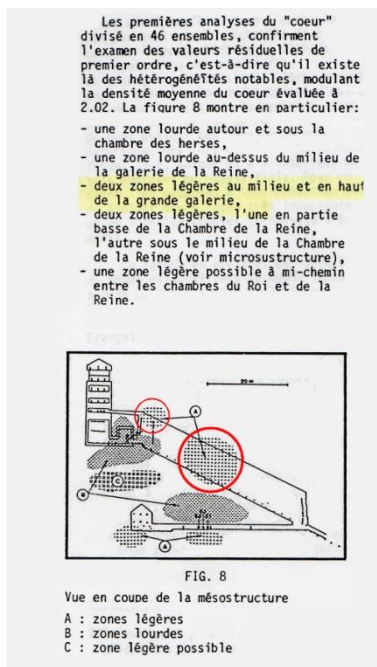

- two light zones (A) in the middle and at the top of the Grand Gallery: the one at the top could indicate the small corbelled chamber mentioned on the previous page; the one in the middle, the presence of "something" of great size on the path of the Noble Circuit, between the second entrance chamber and the King's Chamber.

¹⁵⁰ The Bent and the Red at Dahshur, and the one at Meïdoun.

¹⁵¹ See paragraphs 3 and following on page 29.

¹⁵² See The BIG VOID, starting on page 9.

¹⁵³ The famous "relieving chambers" above the King's Chamber.

¹⁵⁴ The structure resembles an armored trench, with granite beams acting as struts.

¹⁵⁵ See Memoir The BIG VOID, *Information Note No. 5*, pages 74 to 81.

STRABO'S PORTCULLIS CHAMBER

As the under-density anomaly lies to the West of the Grand Gallery, I "flipped" the right-hand image on the previous page to compare it with the architecture of the pyramid containing the Noble Circuit that I had modeled in 3D. I applied a copy of this to the model, adapting it to the viewing angle. The anomaly was exactly in the "protected zone" in the Northern part and on the possible route of the Circuit Noble!

What's most remarkable is that I didn't use the anomaly as the starting point for imagining a possible antechamber close to the King's Chamber, but rather a logical deduction from the thoughts that had led me to the theory of a second circuit linking the King's Chamber to the outside world.

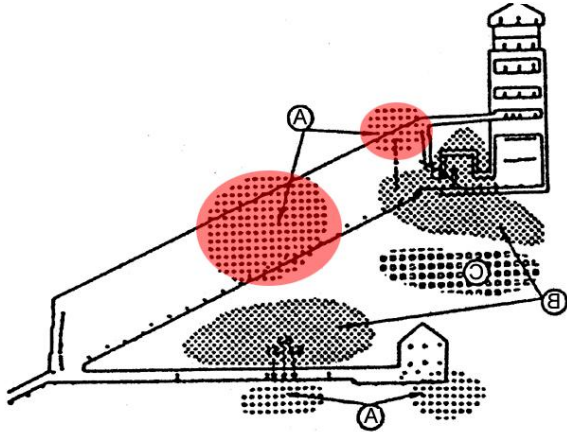

"Flipped" image with light areas (A).

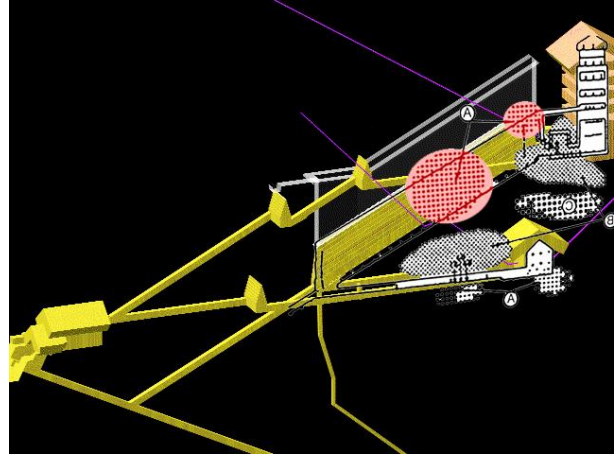

Application of the "flipped" image adapted to the viewing angle applied to the 3D model of the Noble Circuit without "something" between the second entrance chamber and the King's Chamber. The anomaly in the middle and West of the Grand Gallery lies in the "protected zone" of the oblique load transferred by the rafters of the roof's Northern slope.

Considering this very serious clue, I developed a series of 3D models to test different versions of the Noble Circuit route and funerary apartments with one or two antechambers.

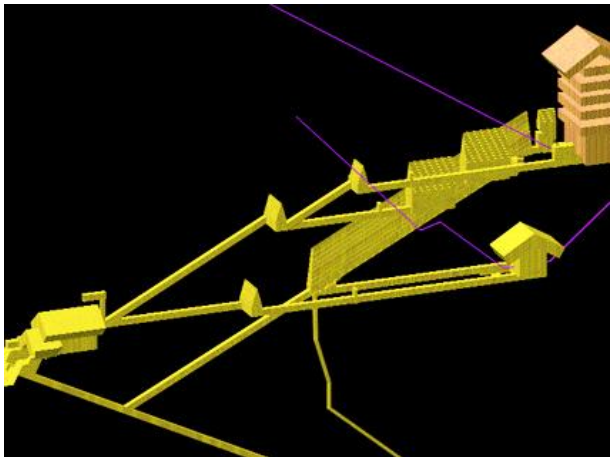

Above, a July 2003 version featuring 2 antechambers as in the Red Pyramid at Dahshur, but slightly offset in height. The Noble Circuit doesn't cross the antechambers.

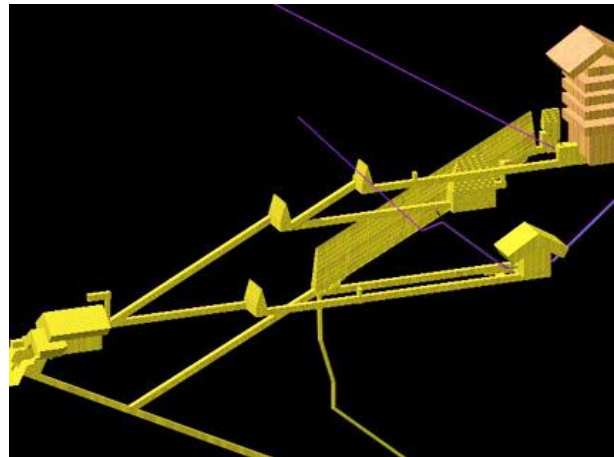

Above, a November 2003 version with 1 antechamber as in the Bent pyramid.

The Noble Circuit does not cross the antechamber. In both versions, the North shaft of the Queen's Chamber does not conflict with the whole.

STRABO'S PORTCULLIS CHAMBER

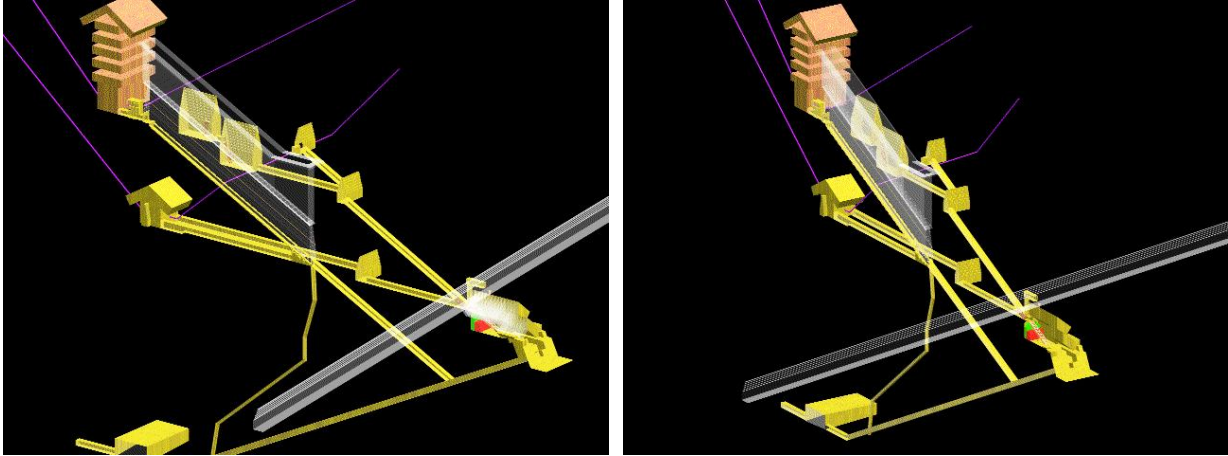

Two views from two different angles of the Circuit Noble (with the Grand Gallery in transparency and its last section connecting to the King's Chamber not shown) as defined in autumn 2003, with its main basic components.

In relation to the text that Strabo left us about Khufu's Pyramid,

"At a certain height on one of its sides is a stone that can be removed, and, once removed, reveals the entrance to a tortuous gallery or syringe, leading to the tomb", the consistency is total:

- At a certain height on one of its sides, in this case the North face at a height of 17 m,

- is a stone, the "notched" stone I've dubbed the "Strabo Stone", which stands at the junction of two entrance chambers connected to the outside at the mouth of the descending corridor,

- that can be removed, since it was put in place when the pyramid was closed after Khufu's funeral, by being slid under the low rafters at the junction of the roofs of the first and second chambers,

- and, once removed, reveals the entrance, i.e. the second entrance chamber at the bottom of which lies the start of the Noble Circuit,

- from a tortuous gallery or syringe, a second ascending corridor parallel to the known one, but which must change axis in the vertical plane during its course in order to reach the tomb

- leading to the tomb, which comprises the King's Chamber and one or two antechambers in keeping with the funerary architecture of the period.

Finally, the architects added a second horizontal corridor built on the same level as the Queen's Chamber, linking the second entrance chamber directly to it. This corridor would have served as a funerary route in the event of King Khufu's untimely death and the use of the Queen's Chamber as an emergency tomb. That said, it was also essential¹⁵⁶ for the duration of the pyramid's construction, right up to delivery of the monument.

To sum up, by the end of 2003, all the major principles constituting the overall theory had been imagined during these first five years. The years that followed focused on improving the theory's logic and simplicity, and on a constant search for clues to support its plausibility.

¹⁵⁶ It was through this that access to the King's Chamber was maintained during the use of the counterweight in the second Grand Gallery, the ascending corridor of the Circuit Noble being neutralized by the roller train's ballast roller as previously in the Grand Gallery. See Memoir The BIG VOID, pages 12 and 13.

6 - EVOLUTION OF THE "NOBLE CIRCUIT" THEORY BETWEEN 2004 AND 2011

Architecture is "*The Art of designing and constructing buildings*", and one of the main missions of this Art is to reconcile their "FUNCTION" and their "FORM" in an aesthetic creation, which can translate into a multitude of solutions...

After the date-setting submission of documents¹⁵⁷ entitled "*Khufu's Pyramid, the new circuit of the entrance to the King's Chamber and the route of the funerary procession*" in early 2004, I decided not to unveil this new part of my research, preferring to concentrate on the basic theory and its dissemination to the public.

Although not part of the world of Egyptology, my work had received special attention from Mme Christine Cardin, organizer of the 9th International Egyptologists Congress to be held in Grenoble from September 6 to 12, 2004. At her invitation, I was lucky enough to give a "*Communication*¹⁵⁸" on the opening day of the Congress, followed two hours later by a "*Conference*¹⁵⁹"; this double event was my first immersion in this world¹⁶⁰ and marked the beginning of my research *in situ*, my first encounter with Khufu's Pyramid taking place just one month later, on October 6.

That said, as I came to understand more and more the way designers think, I immersed myself into the Noble Circuit from time to time, modeling in 3D ideas that came to mind in order to streamline its architecture.

And so, between early 2004 and late 2005, my vision of the "funerary apartment" came closer to the interior architecture of the Red Pyramid at Dahshur, with its two antechambers. Henceforth, the Noble Circuit would pass through them before reaching the King's Chamber.

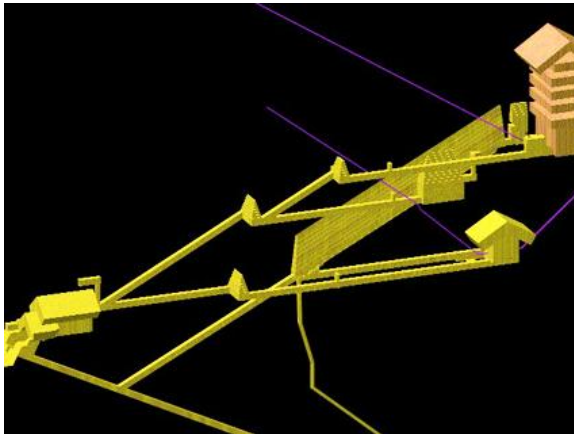

This January 2004 version is a slightly revised version of the November 2003 version.

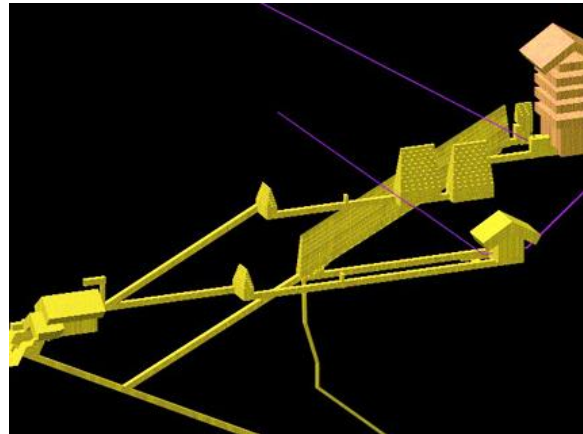

In this October 2004 version, the Noble Circuit now passes through 2 antechambers inspired by those in the Red Pyramid at Dahshur. This architecture would later become what I dubbed "Snefru's Legacy".

¹⁵⁷ In France, on March 4 2004 at SACD, in the USA, on April 5 at the Copyright Office.

¹⁵⁸ On the subject of the following non-destructive investigation techniques:

Microgravimetry, photo thermal detection, radar reflectometry, ultrasonic echography and seismic tomography, multi-electrode devices, Slingram electromagnetic techniques, magnetotelluric radio and architectural photogrammetry.

¹⁵⁹ Reconstruction of the Great Pyramid construction site

¹⁶⁰ The same day I met for the first time the Secretary General of the Egyptian Supreme Council of Antiquities (SCA), Dr Zahi Hawass, following an introduction by Prof. Hany Helal.

STRABO'S PORTCULLIS CHAMBER

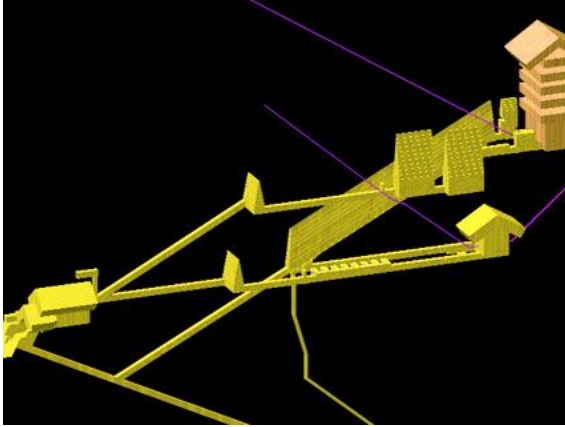

This March 2005 version is a slightly revised version of the October 2004 version. The roller storage "magazines" of the roller train are visible in the horizontal aisle.¹⁶¹

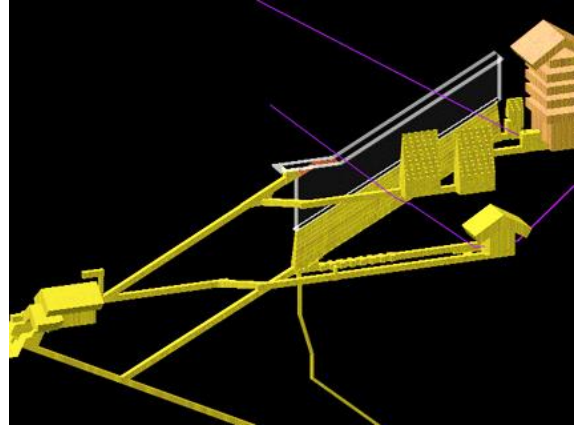

In July 2005, the Noble Circuit's axis changes with a 45° connecting corridor. The masonry elevation¹⁶² is transparent. The first section of the second ascending corridor joins it for direct access to the construction site.

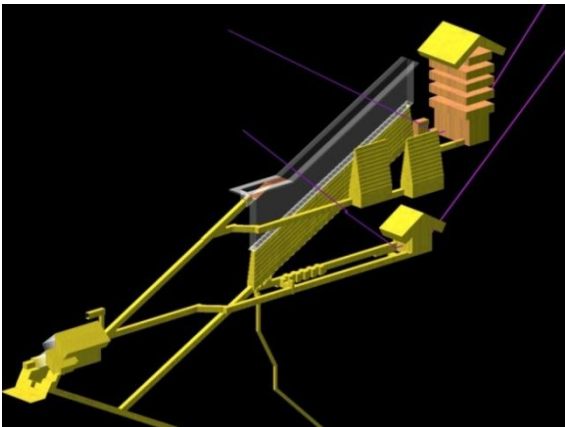

In this September 2005 version, access to the King's Chamber is closed directly from the second antechamber, as in the Red Pyramid.

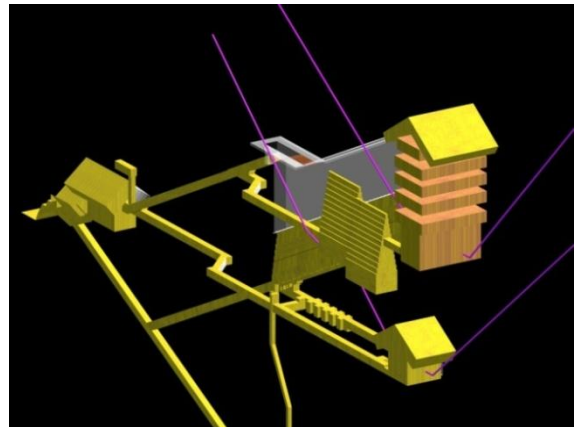

In this other view from the September 2005 version, we can see why Strabo refers to a "*tortuous gallery or syringe leading to the tomb*".

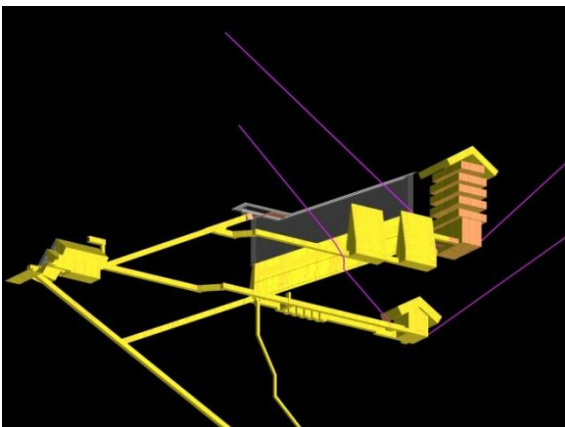

In this last view from September 2005, we also understand why on November 22, 2016¹⁶³, when the Japanese teams announced the discovery of a very large anomaly above the Grand Gallery, I immediately said it was a second Grand Gallery!

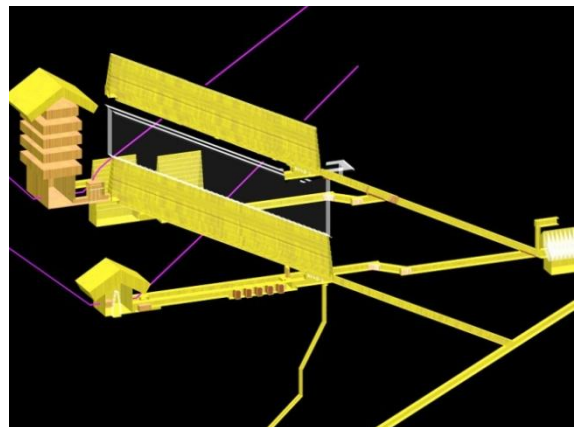

I had the whole architecture of the Noble Circuit and the counterweight system in my head so much that my first reaction was totally natural. It was a possibility that floated around in my head at the beginning of 2010, without really believing in it because it would have required an enormous vacuum.

¹⁶¹ See Memoir The BIG VOID, page 13.

¹⁶² See Memoir The BIG VOID, pages 13, 14 and 19.

¹⁶³ See Memoir The BIG VOID, page 20

STRABO'S PORTCULLIS CHAMBER

As for the basic theory, this evolved, with the internal ramp becoming narrower following the separation of the flows of the teams assigned to pulling the blocks. The men now returned to their base via an external wooden walkway running parallel to the internal ramp. This change provided the opportunity to produce a new full 3D model¹⁶⁴ of the pyramid, in which I represented the progression¹⁶⁵ of the second section of the internal ramp between the North-East and North-West edges, and its passage over the entrance without representing the second entrance chamber. I included a detail, my intention being to be able to say one day that I had left a clue to the Noble Circuit theory. I also modeled a temporary masonry "Royal Entrance" to replace a wooden scaffold¹⁶⁶.

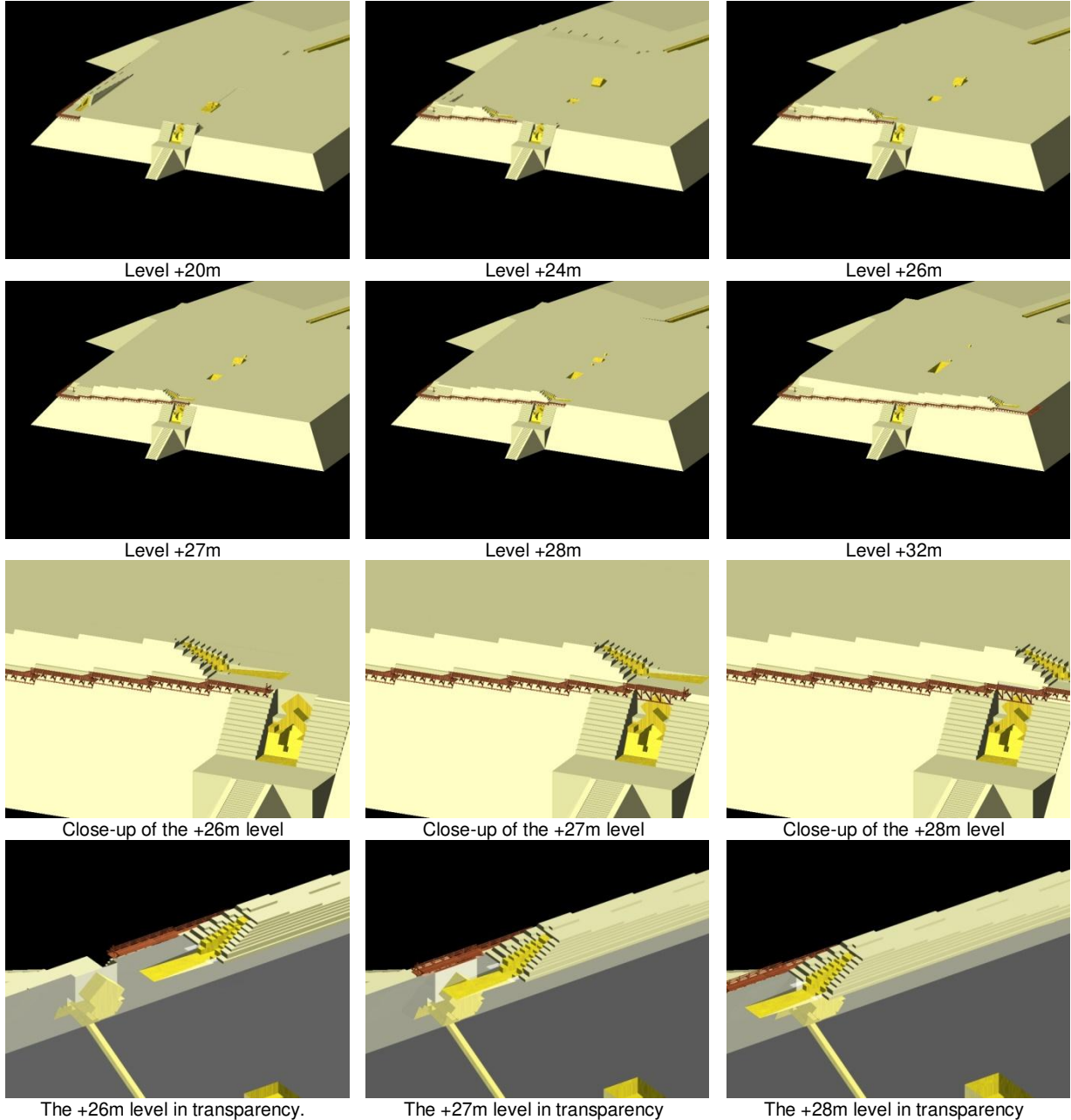

¹⁶⁴ This 3D model will become the basis for the images of the theory reproduced in the book KHUFU, THE SECRETS BEHIND THE BUILDING OF THE GREAT PYRAMID, Jean-Pierre Houdin - Farid Atiya Press 2006.

¹⁶⁵ Pages 58 to 65 of the above book.

¹⁶⁶ See the last sentence of the legend under the 3D model on the previous chapter page.

STRABO'S PORTCULLIS CHAMBER

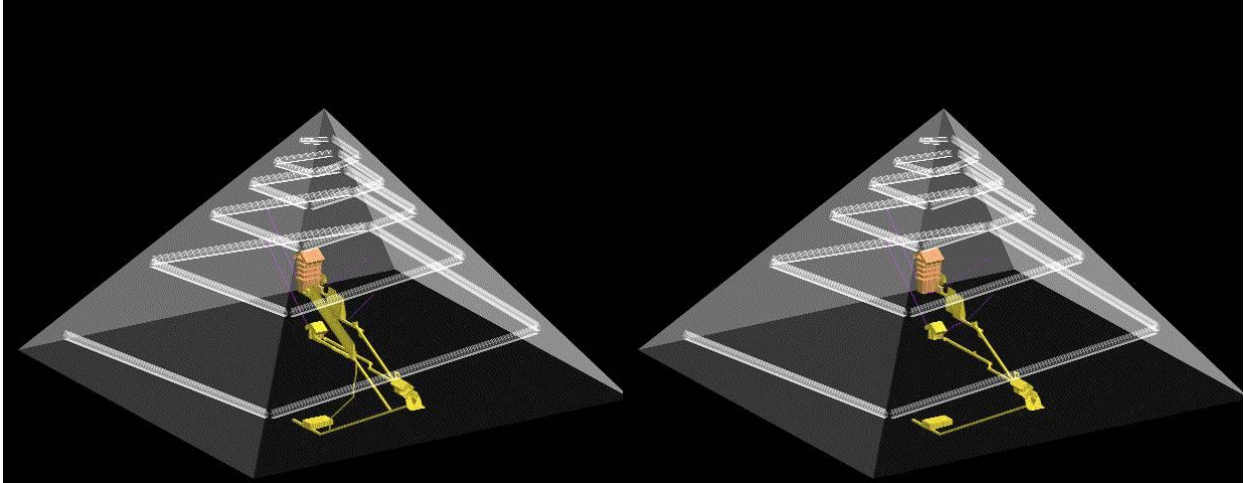

Transparent view of the pyramid from the North-East, showing the known interior structures plus all the structures on the Noble Circuit, from the entrance on the North face to the King's Chamber. The internal ramp is shown in transparency.

Same transparent view of the pyramid from the North-East, with all the structures of the Circuit Noble, from the entrance on the North face to the King's Chamber, but without the following known structures: the ascending corridor, the horizontal corridor and the Grand Gallery. If the King's Chamber had been covered by a corbelled vault, these structures would not have been necessary and construction would have been simpler.

In September 2005, I presented this 3D model of my work to Mehdi Tayoubi and Richard Breitner at Dassault Systèmes¹⁶⁷. Following this meeting, the company welcomed me at the beginning of 2006 into its "*Passion for Innovation*" sponsorship program for an exemplary collaboration. From then on, all my new 3D models will be produced using the company's¹⁶⁸ software.

In view of the magnitude of the proposals contained in the¹⁶⁹ theory I presented at our first meeting, it was decided to begin by dealing with the construction of the pyramid and to postpone the Noble Circuit, the completion of this second part being linked to the success, or otherwise, of the first part.

Throughout 2006, a complete 3D modeling of the pyramid's construction site was carried out, culminating on March 30, 2007 at the Géode in Paris in the presentation of "*Khufu Revealed*"¹⁷⁰, which made my work known worldwide within twenty-four hours.

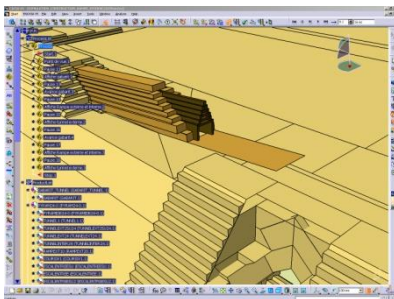

3D model of the internal ramp above the entrance rafters using CATIA software

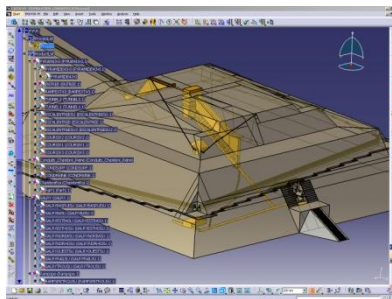

3D model of the pyramid under construction using CATIA software.



3D model of the pyramid at level +43m in the "*Khufu Revealed*" presentation at La Géode.

¹⁶⁷ See The BIG VOID Memoir, last paragraph on page 2 and notes 7, 8 and 9.

¹⁶⁸ CATIA, DELMIA, SIMULIA and VIRTOOLS. These programs have contributed to the impressive development of my work, with the help of two specialists by my side, Jacques Jaworski and Alain Dugousset.

¹⁶⁹ Pyramid building on one side, the Noble Circuit on the other.

¹⁷⁰ A real-time 3D presentation projected onto a 400m² hemispherical screen, with animations created by the talented team at EMISSIVE, a start-up created by Emmanuel Guerriero and Fabien Barati.

STRABO'S PORTCULLIS CHAMBER

Following the success of this presentation, my collaboration with Dassault Systèmes was renewed for the second part of my proposals, the modeling of the Circuit Noble, with the project starting in early 2010 with the same "Khufu team". In the meantime, having continued my research¹⁷¹, in particular an update of the North entrance, a new 3D model¹⁷² became necessary.

Between the end of 2004 and the beginning of 2010, I had the opportunity to make some fifteen visits to Cairo, during which I visited the Khufu Pyramid on numerous occasions¹⁷³. I had the privilege of entering into areas not accessible to the public during the filming¹⁷⁴ of documentaries, even going under the rafters of the roof of the King's Chamber for one sequence. I also had the opportunity to study the rafters very closely, the Strabo Stone in particular, and the elements of the structure still visible¹⁷⁵ where the first entrance chamber once stood. While I was there, I realized that the descending corridor was very close indeed, right in line with the oblique slabs, and that it was much simpler and more logical to create the Noble Circuit connection directly to it from the first entrance chamber.



View of the descending corridor, the large oblique slabs and the Strabo Stone. The side walls form part of the basic structure of the first entrance chamber and are 7 cubits (3.68 m) apart.



Looking down from the platform in front of the Strabo Stone onto the descending corridor. Lateral benches of 2 cubits each on either side of the descending corridor left a 3-cubit well centered on the 2-cubit-wide corridor. The remaining cubit was distributed on either side of the descending corridor to create supports for closing slabs.

There are two technical reasons for the presence of the large oblique slabs between the Pierre de Strabo level and the descending corridor:

- to block, by their inclination and weight, the masonry area under the second entrance chamber above the descending corridor,
- to create the South wall of a well linking the descending corridor and the base of the Strabo Stone.

The interior architecture between the visible side walls and the descending corridor was completed by masonry fittings (in the spirit of the side benches in the Grand Gallery), leaving only twenty centimeters of support on either side. Limestone slabs were used to close off access to the connecting well¹⁷⁶.

¹⁷¹ For example at the grid-based design level. See Memoir The BIG VOID, *Note d'information N°4*, pages 54 and 55.

¹⁷² This 3D model was created by parameterizing CATIA software on the basis of the Egyptian measurement system of the time: cubits, palms and fingers. Probably the only model of this kind in the world.

¹⁷³ Professor Hany Helal obtained a "pass" for me for each stay. All in all, I spent over 6 months in Cairo.

¹⁷⁴ See Memoir The BIG VOID, page 4 notes 24, 25 and 26.

¹⁷⁵ The gaping hole in front of the rafters.

¹⁷⁶ This section is covered later in Chapter X, starting on page Y.

STRABO'S PORTCULLIS CHAMBER

The result was clear: as far as I was concerned, there was only one way out via the descending corridor, and only one block to be inserted into it to seal the pyramid. The real defensive barrier lay between the two entrance chambers, and that was the "Strabo Stone".

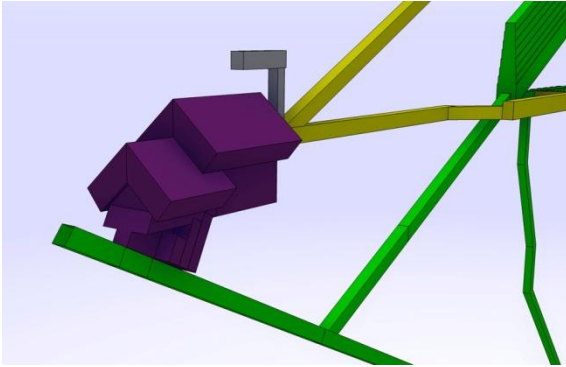

3D modeling¹⁷⁷ of the two entrance chambers (in purple) linked to the descending corridor (in green) by a connecting well grafted (in purple) onto the latter a few meters from its outlet to the outside.
The Noble Circuit (in yellow) runs to the rear at the top of the second chamber. The evacuation well for the workers sealing the pyramid from the inside (in grey) is just behind the South wall of this chamber.

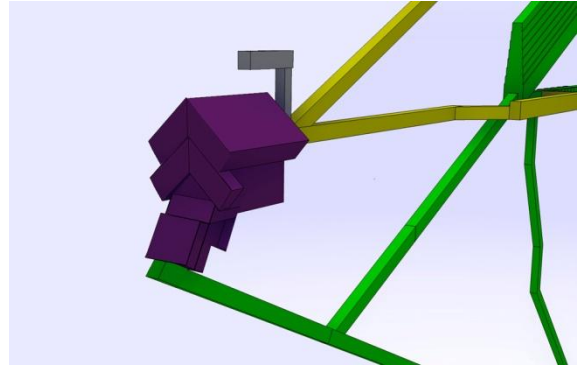

3D modeling of the current condition of the entrance to the Circuit Noble.
The first chamber, the connecting well and part of the descending corridor have disappeared, leaving a gaping hole at the foot of the pairs of rafters visible on the North face. All that remains of the well are the large sloping slabs that formed its Southern wall.

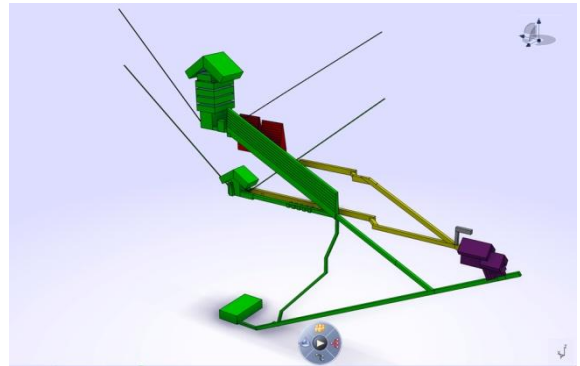
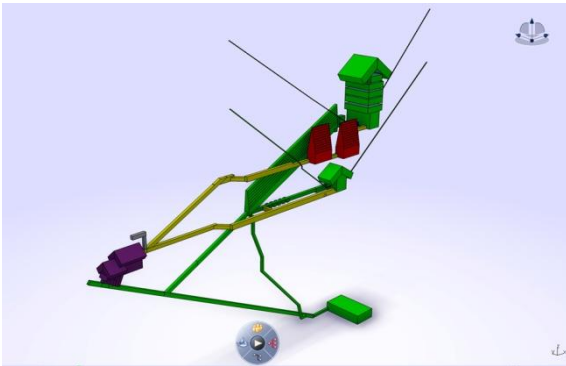

Latest CATIA 3D model produced for the "Khufu Reborn" presentation on January 27, 2011 announcing the probable presence of a Circuit Noble and antechambers near the King's Chamber.

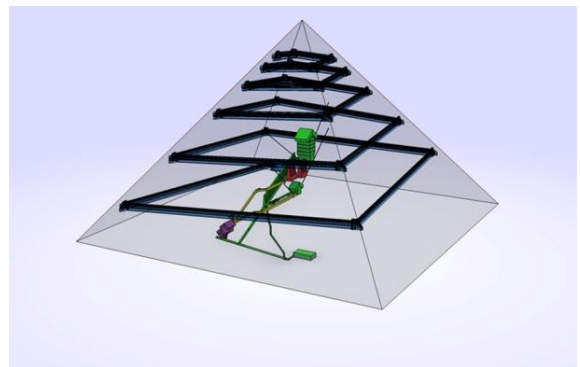
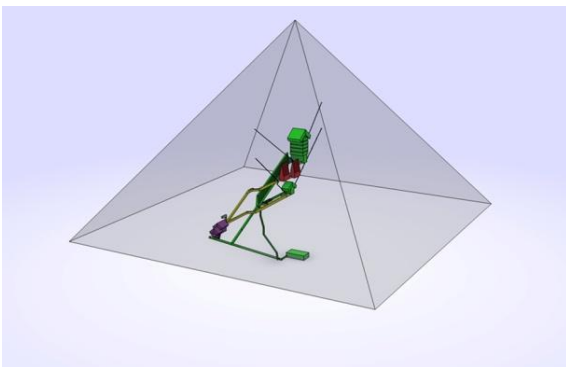

View of the pyramid without and with the internal ramp

¹⁷⁷ 3D scientific models produced in collaboration with Alain Dugousset.

STRABO'S PORTCULLIS CHAMBER

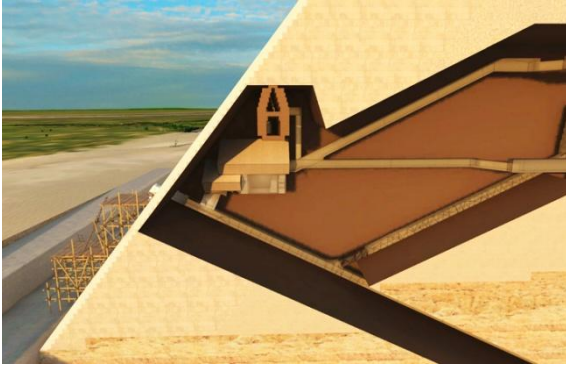

View from the West of the artistic 3D model¹⁷⁸ of the entrance area on the North face with descending corridor, the connecting well to the two entrance chambers and the corridors of the Noble Circuit, one horizontal to the Queen's Chamber, and one ascending to the funerary apartment. A vertical well allows the last workers to leave the pyramid via the upper level of the internal ramp.



Close-up of the connecting well linking the downward corridor to the first entrance chamber. Ceiling slabs for the descending corridor are stored at the base of the well. In the background, the Strabo Stone is temporarily stored at the bottom of the second entrance chamber.



Rear view of the same elements, with a close-up of the second entrance chamber. The Strabo Stone is shown twice: in its storage position at the rear of the second chamber (transparent), and in its final position at the front of the chamber. Limestone masonry has been laid on top of it.

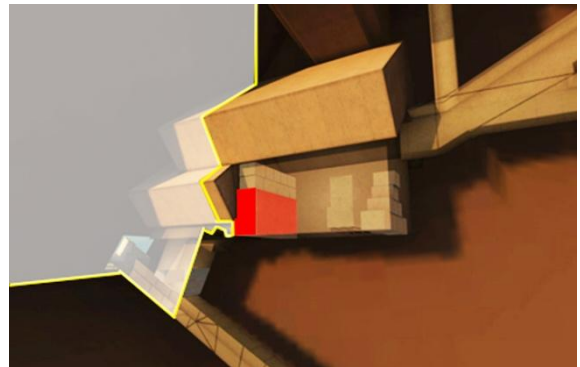

Identical view with more details:
The Strabo Stone is in red.
The yellow line shows the boundary between the original shape and the current shape of the entrance area. The area to the left of the line no longer exists, replaced by the gaping hole above the descending corridor and beneath the rafters visible on the façade.

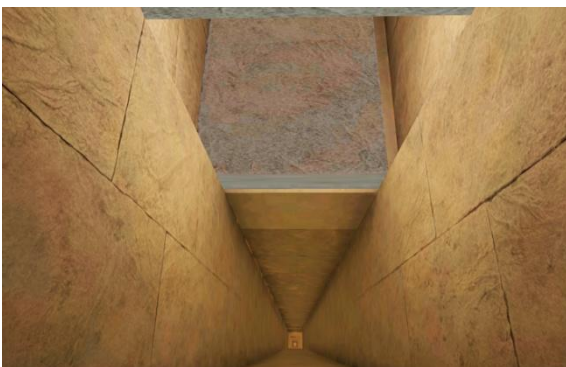

View, from the descending corridor, of the connecting well opening onto the first entrance chamber. A ceiling slab for the descending corridor is on standby, pressed against the large sloping slab blocking the masonry in the area.

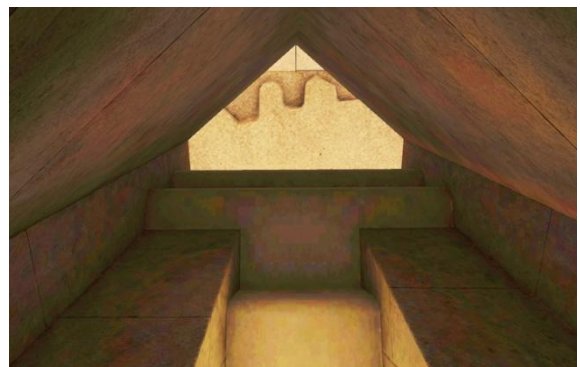

View of the connecting well opening into the first entrance chamber. Lateral benches are used for maneuvering objects to the Noble Circuit and the funerary apartment. They were also used to transfer the King's mummy during his funeral. The highlighted Strabo Stone is in its final position, between the first and second chambers.

¹⁷⁸ A series of 3D artistic renderings modeled by Pierre Gable of Emissive and his collaborators. He would later produce all the 3D models for the ScanPyramids mission.

STRABO'S PORTCULLIS CHAMBER

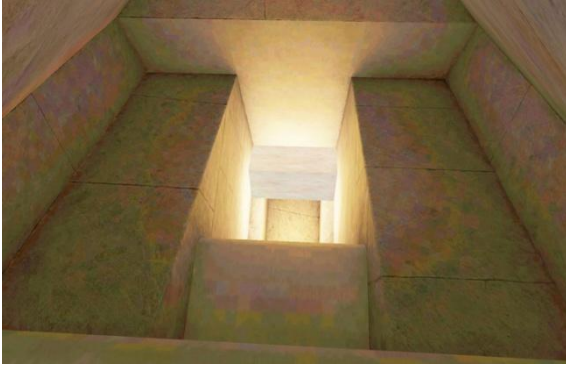

Turning away from the Strabo Stone, view of the opening of the connecting well into the first entrance chamber and its lateral benches. The descending corridor is illuminated by the outside light entering a few meters into it.



View of the Strabo Stone as it is stored at the rear of the second entrance chamber. Masonry blocks are also stored behind it to finish sealing. The start of the Noble Circuit is in the back wall, at floor level of the Queen's Chamber.

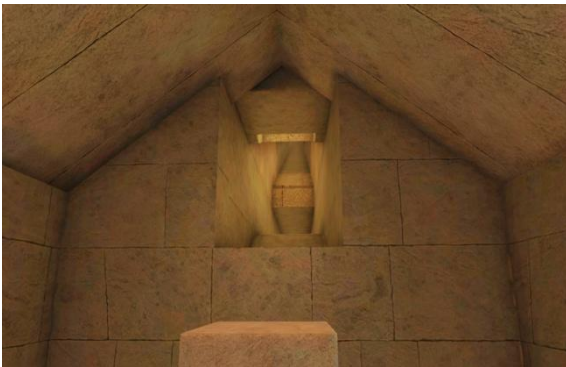

Close-up view of the start of the Noble Circuit. In the background, the new ascending corridor is above the new horizontal corridor, in an architecture based on that of the junction of the known horizontal corridor and the Grand Gallery.



Strabo's Stone in its final position at the front of the second entrance chamber. Additional masonry was built above it. Two blocks of this wall are visible from the outside, above the Strabo Stone and behind the lower pair of rafters.

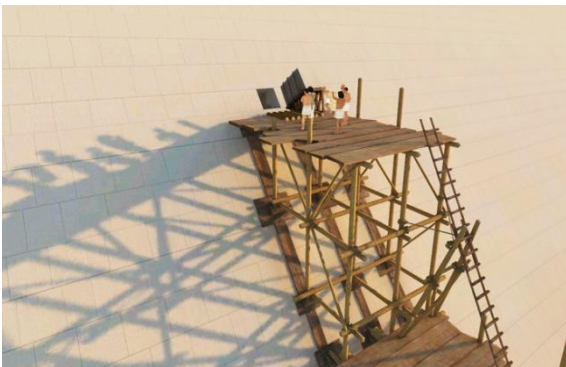

The exterior wooden scaffolding providing access to the pyramid's unique entrance. The Turah limestone block sealing the descending corridor was installed on an inclined portico on rollers before the funeral.



The funeral is over, and the Priests recite the last funeral formulas before the workers push the closing block in front of the opening of the descending corridor, freeing it to slide inside.

STRABO'S PORTCULLIS CHAMBER



Left, current view of the descending corridor; right, view of the descending corridor before the pyramid was sealed. Architects Hemiunu and Ankh-haf demonstrated extraordinary mastery of the art of design and construction.

As for the internal ramp, following the rediscovery, during the filming of the¹⁷⁹ documentaries in 2008, of a¹⁸⁰ "cupola"-shaped room behind the notch visible in the pyramid's North-East edge, I updated it once again. From then on, there were no longer any external notches for the rotation of the sledges, this being carried out inside the pyramid in "rotation rooms". As a result, the exterior wooden walkway was eliminated and replaced by an internal ramp with two levels¹⁸¹, a low level for pulling the sleds, and a high, corbelled level for the return of the teams¹⁸². This update simplified the construction process, eliminating the need for any intervention at the end of the project, as the pyramid's faces were definitively completed during construction, eliminating the need to fill in the notches and dismantle the outside walkway.

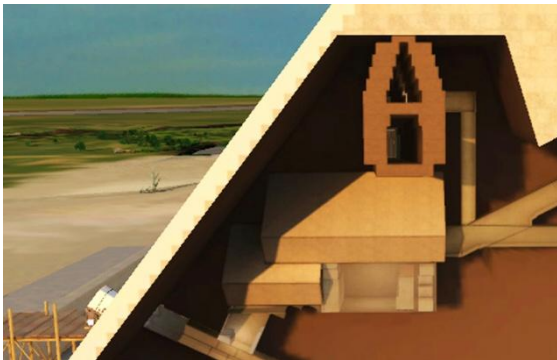

The latest iteration of the two-level internal ramp shape presented at the Circuit Noble announcement on January 27, 2011 at La Géode. Following the discovery of the SP-NFC, a slight update will be made.

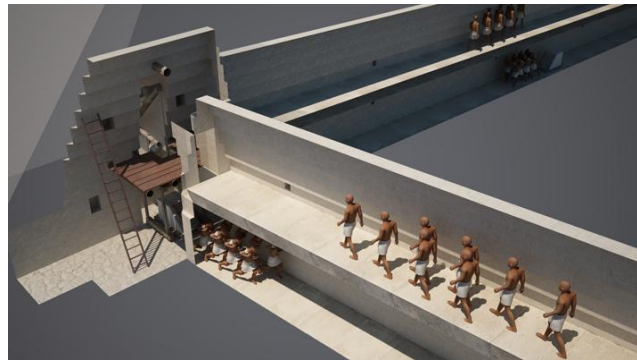

The internal ramp has two levels, the lower one used to pull the block transport sleds, the upper one for the teams to return to their base.

In the corners, the rotation rooms are also on two levels, separated by a wooden floor.

In summary, on October 25, 2015, the day the ScanPyramids mission was launched, the Noble Circuit was well defined in terms of its function, i.e. to link the exterior directly from the single entrance into the pyramid on the North face to King Khufu's funerary apartment at the heart of the monument. Along the way, the architects had planned two entrance chambers, the first opening directly onto the descending corridor, the second contiguous, for the future installation of a barrage portcullis, the

¹⁷⁹ See Memoir The BIG VOID, last paragraph on page 4 and notes 24, 25 and 26.

¹⁸⁰ Which I dubbed Bob's Room after my American Egyptologist friend Bob Brier, who rediscovered it during the shoot.

¹⁸¹ In 2000, architects Gilles Dormion and Jean-Yves Verd'hurt discovered corbels above the descending corridor and the two antechambers of the Meïdoum pyramid, attesting to the Egyptians' expertise in this field.

¹⁸² This latest iteration of the internal ramp will be covered in the 3rd part of the forthcoming trilogy: "Khufu's Pyramid, recent discovery of a cavity under the North-East edge by the ScanPyramids mission".

STRABO'S PORTCULLIS CHAMBER

Strabo Stone. These were followed by two new corridors, a horizontal one leading to the Queen's Chamber on the same level, and a new, tortuous ascending corridor leading to the funerary apartment, comprising two antechambers and the King's Chamber. A vertical well at the start of both corridors led to the top of the internal ramp crossing the Circuit Noble just above the second entrance chamber. It was via this well that the last workers, sealing the access to the interior of the pyramid once and for all, would be able to leave the pyramid once their task was completed.

That said, regarding the shape of the chambers and corridors along the way, each of those presented were just a very plausible solution from my reflections. As I said at the beginning of the chapter about Architecture: *"...this Art is to reconcile their "FUNCTION" and their "FORM" in an aesthetic creation, which can translate into a multitude of solutions"*. I was well aware that the form of some of the Noble Circuit's components could be revised following an investigation mission, but that their function would not change.

There were still a few loose ends to tie up:

- the decision to push the Strabo Stone on rollers from the rear of the second chamber, where it was stored for positioning, was influenced by its weight of at least 6 tons¹⁸³, and by a detail noted on Gilles Dormion's plan N°5: a perfectly flat surface¹⁸⁴ in front of the Strabo Stone, a sign of a support prepared for moving it. As a consequence, the second chamber was oversized for this reason.

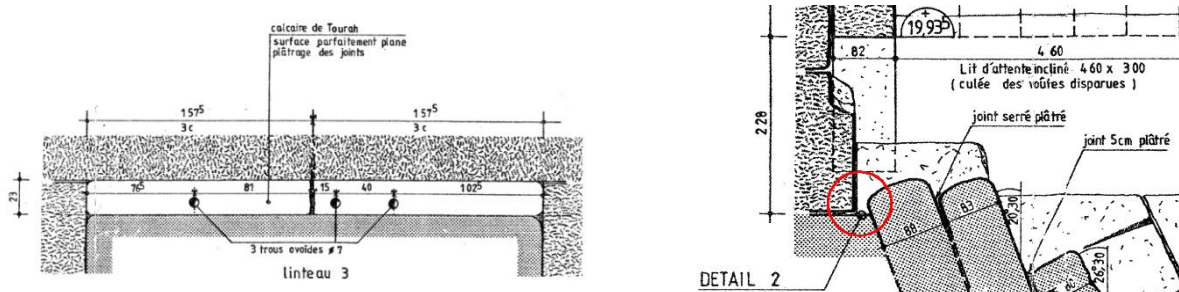

Plan and cross-section of the original floor between the Strabo Stone and the 3rd sloping slab. The plan reads: "Turah limestone, perfectly flat surface, plastered joints". Another detail on this plan, the 3 ovoid holes, is also important.

- I was puzzled by the absence of voids in the microgravimetry images, which only indicated a strong overdensity¹⁸⁵, hence the possibility that the chamber had been filled with sand after the funeral.
- Strabo's Stone was as it was, with its "notches" at the top, because it had first played a role¹⁸⁶ during the construction of the first chamber, before becoming a blocking stone. Its shape, size and weight were the result of this.
- for the "tomb" with one or two antechambers, I finally opted for the two-antechamber version inspired by those in the Red Pyramid, because it fitted perfectly into the 1-square cubit "grid" that the architects used in their design. What's more, the deviation of the North shaft of the Queen's Chamber could be explained by the position of the Noble Circuit corridor as it approached the tomb.

¹⁸³ Given the space available, lowering a block of this weight like a portcullis became very problematic.

¹⁸⁴ Unfortunately, a few years ago the Antiquities Department filled in the gap between the 3rd slab and the Strabo Stone, obliterating an archaeological piece of evidence!

¹⁸⁵ I imagined that microgravimetry should have indicated an average density between the Turah limestone rafters and the sizeable void they covered.

¹⁸⁶ As with many other components of the pyramid, they have a dual function, sometimes to the detriment of one of the two.

STRABO'S PORTCULLIS CHAMBER

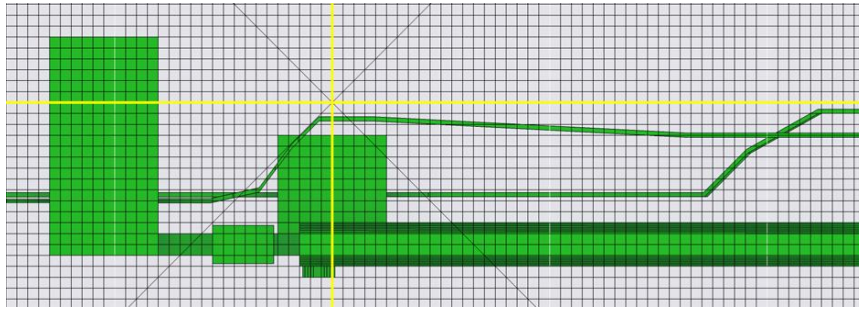

View of the plan projection of known structures in the pyramid on the 1-square cubit design grid (in black).

All structures fit perfectly into this grid. North-South and East-West axes are marked in yellow.

The primary grid of 20 square cubits was used for the design of the volume and its layout on site (in white).

The North shaft of the Queen's and King's Chambers depart from this rule, being diverted to avoid obstacles and for technical reasons linked to the intercom system¹⁸⁷.

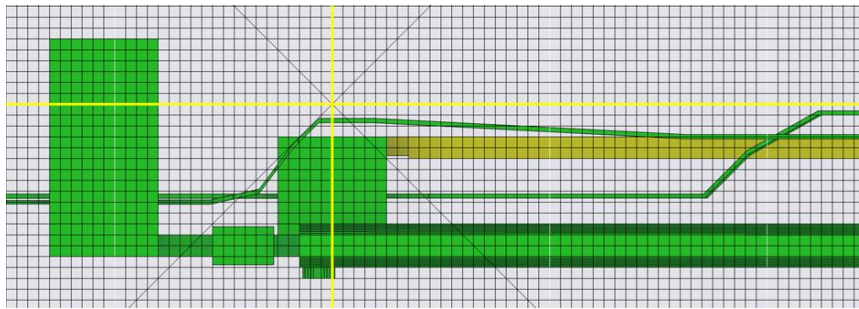

The second horizontal corridor (in yellow) of the Noble Circuit arrives in the North-West corner of the Queen's Chamber, parallel to the known horizontal corridor beneath the Grand Gallery, at the level of the passage between its side benches (in light green). The North shaft runs between the two corridors for some fifteen meters before being diverted to the West.

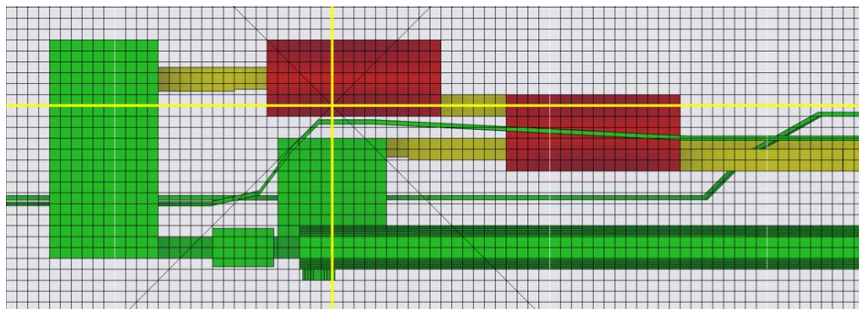

The second ascending corridor (in yellow) of the Noble Circuit arrives near the North-West corner of the King's Chamber, parallel to the corridor of the Portcullis Chamber. It enters the first antechamber through the North-East corner, exits through the South-West corner and enters the North-East corner of the second antechamber. It joins the King's Chamber at around +8 m above ground level, in line with the second antechamber. The North shaft of the Queen's Chamber is diverted to pass under the ascending corridor and resume its course close to the North-South axis.

The North shaft is centered on that of the Queen's Chamber, passing between and above the two antechambers and continuing along the North-South axis.

This solution was well-defined and supported by solid evidence: the insertion into the design grid, the offsetting of the North shaft of the Queen's Chamber, the under-density revealed by microgravimetry and the protection of the antechamber corbels against the load above the King's Chamber transferred obliquely by the chevrons roof heightened by the superstructure of the five ceilings.

In the end, a solution with a single antechamber was still a possibility, but I had to make a choice.

¹⁸⁷ See Memoir The BIG VOID, from Information Note N°5, page 74 to page 81.

7 - THE SCANPYRAMIDS MISSION AND THE DISCOVERY OF THE SECOND ENTRANCE CHAMBER

Information note N°3 :

Before retracing the steps that led to the "historic" discovery of the second entrance chamber behind the rafters above the official entrance to the Khufu Pyramid by the ScanPyramids mission, I'd like to present a short summary of the various actions that have been undertaken since the early 2000s in the research, analysis and selection of non-destructive investigation techniques that could potentially be applied to this monument. This long quest, supported by the ACGP¹⁸⁸, with the backing of numerous scientists and some twenty patrons, as well as hundreds of enthusiasts of Ancient Egypt, particularly of the era of the Great Pyramids, has enabled me to learn and understand the scientific contribution that each of these techniques could make to the archaeology of the 21st Century.

Eight years have passed since the mission's first investigations, and the results have lived up to expectations. Not since the often invasive explorations of the 19th century¹⁸⁹, which uncovered unknown volumes in the body of Khufu's Pyramid, has there been so many archaeological breakthroughs. The list is astonishing: the BIG VOID, the SP-NFC and the Cavity C1! The scientific technologies currently available have thus earned their right of entry into the world of archaeology, something that was not obvious just a few years ago, with some openly denying them any interest.

After the discovery of the "forgotten" documents from the¹⁹⁰ microgravimetry mission carried out in 1986 and 1987 under the aegis of the EDF Foundation, and with a view to a future mission, in November 2001 my father Henri and I spoke at the ENDGC2 Scientific Days¹⁹¹ in Bordeaux, asking the scientists present this simple question about Khufu's Pyramid:

"Do you think that the discipline you master could be used to locate sections of galleries set back 3 meters from the current face wall?"

The first contacts with specialists in non-destructive investigation techniques began following this question, particularly in infrared and ground penetrating radar¹⁹². Contacts increased between 2002 and 2004, as the interest of scientists in a mission to the Khufu Pyramid and the challenge it entailed were highly motivating.

At the time of the attempt to obtain authorization for the mission, the results of these years of research were very encouraging, the quality of the future contributors being very flattering; to mention only those who had contributed the best techniques available, I would cite for :

- microgravimetry, SAFÈGE¹⁹³, with Jean-Pierre Baron¹⁹⁴,
- ground penetrating radar (GPR), LERM, with Jean-Luc Garciaz,
- reflectometry radar, THALÈS¹⁹⁵, with François Levieux and Thierry Brizard,

¹⁸⁸ www.association-construire-la-grande-pyramide.org

¹⁸⁹ Especially with explosives.

¹⁹⁰ See page 12.

¹⁹¹ Non-destructive evaluations for civil engineering, organized by LCPC, EDF, LMP and CDGA.

¹⁹² The LERM later joined the mission project prepared by the ACGP and the ECAE of Cairo's Faculty of Engineering.

¹⁹³ Heir to the CGPF, which carried out the 1986/87 microgravimetry mission.

¹⁹⁴ Member of the above mission.

¹⁹⁵ In 2004, THALES carried out two limestone investigations specifically for this project, in the basement of the Château de COUCY in the Aisne department and in a tower of the Château de PIERREFONDS in the Oise department. Detection capabilities were thus measured in situ.

STRABO'S PORTCULLIS CHAMBER

- infrared thermography, TCC, with Jean-Claude Barré¹⁹⁶,
- architectural photogrammetry and geomatics, INSA Strasbourg - MAP-PAGE UMR 694, with Pierre Grussenmeyer,
- electrical tomography (electrical sounding), Université Pierre et Marie Curie Paris 6 - UMR 7619 Sisyphé, with Pierre Andrieux and Roger Guérin,
- seismic detection, the Acoustic Waves Laboratory at ESPCI¹⁹⁷, with Mathias FINK and Michael TANTER.

I wanted to introduce and thank all these institutions and companies, and the people in charge, who gave so much of their time to the 2005 mission project, but who unfortunately and incomprehensibly did not even have¹⁹⁸ the opportunity to show the authorities that their techniques could become the tools of the future for non-destructive archaeological investigation.

That said, Science can't be stopped, it can only be delayed, but Time is never wasted, allowing us to move forward until the time is right, as demonstrated by ScanPyramids.

In the document "Egypt Fourth Dynasty 34 CLUES IN SUPPORT OF THE THEORY" published on my page ACADEMIA¹⁹⁹, I concluded on the last page:

"In case where the 34 clues above would not be seen as sufficient to support the credibility of the theory, several other clues are kept in reserve".

Before the late 2000s, I was convinced that there was a room behind the entrance rafters, having received information²⁰⁰ regarding the reaction of the rafter area to infrared (IR) thermography.

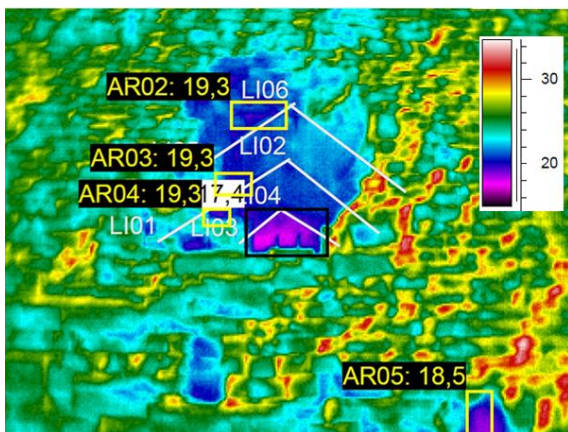

IR image captured in the middle of a year when temperatures recorded on the North face ranged from +22⁻²⁰¹ to +31° at that point. The current entrance was at +18.5° and the Strabo Stone at +17.4°, with the temperature difference as great as 13° (see temperature diagram to the right). Note that the rafters remained cooler than the rest. I deduced that the temperature of the entrance was regulated by the ambient temperature inside the monument while that of the Stone was regulated by air circulation (leaks) coming from a room at the rear of the area.

The gap between the entrance and the Stone was just one degree.

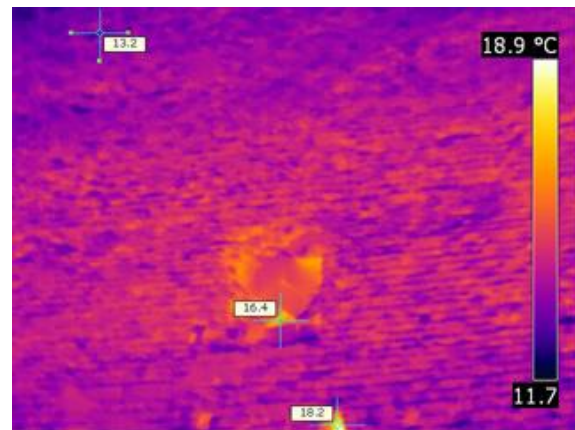

IR image captured at the end of a year when temperatures recorded on the North face ranged from +11.7° to +18.9°. The current entrance was at +18.2° and Strabo's Stone at +16.4°, with the temperature difference as wide as 7° (see temperature diagram right).

While the difference in temperatures recorded on the face between summer and winter could vary by up to twenty degrees, the temperature recorded in the entrance varied by only 0.3° and that of the Stone by only 1°. The entrance, with the pyramid's air at a constant temperature throughout the year, served as a reference for analyzing the temperature of the Stone, which was constantly swept by air from leaks under the rafters.

¹⁹⁶ Jean-Claude Barré took part in the ScanPyramids mission alongside Laval University in Quebec City, and was the first to detect a temperature anomaly under the entrance rafters at Stone level.

¹⁹⁷ Ecole Supérieure de Physique et Chimies Industrielles de la Ville de Paris.

¹⁹⁸ For reasons that have nothing to do with science.

¹⁹⁹ www.independent.academia.edu/JeanPierreHoudin

²⁰⁰ Following the documentary "Kheops Revealed" (2008), in which I mentioned infrared, enthusiasts sought to deepen our knowledge of the 7th Wonder of the World, a World Heritage site.

²⁰¹ In Celsius degrees.

STRABO'S PORTCULLIS CHAMBER

The beginning of investigations on Khufu's Pyramid using infrared thermography.

Just after the launch of the ScanPyramids mission was announced on October 25, 2015, a first short²⁰² infrared thermography mission was carried out by the Laval University team²⁰³ and expert Jean-Claude Barré, first on the Dahshur pyramids, then on Khufu's Pyramid. On the latter, several anomalies were detected, including one at the base of the East face not far from the North-East edge, and a second in the chevron zone above the entrance to the North face.

In the context of this SP-NFC Memoir, the main focus is of course on the discovery of the second anomaly, which was the first clue leading to the discovery of the second entrance chamber.

That said, the first anomaly was unexpected and highly significant, being the subject of ScanPyramids' first announcement to the press by Prof. Hany Helal, the Minister of Antiquities, Dr. Mamdouh Mohamed Eldamaty, Jean-Claude Barré and Clemente Ibarra-Castadena on November 9, 2015. For the occasion, a large screen had been set up next to the anomaly to view the infrared images obtained; these clearly showed significant temperature differences measured between certain contiguous blocks in a specific area at base level and the surrounding masonry as a whole. The infrared images highlighted a particular feature of the area: the blocks concerned were part of a masonry zone that had clearly been reshaped from its original condition.

This discovery should have been appreciated at its true value, but unfortunately some²⁰⁴ people, without any scientific analysis or objectivity, immediately attacked the results, putting forward fallacious arguments²⁰⁵. As a result, it was clear that the mission would have to present unassailable results in the future.

However, with the passage of time and the discovery of the SP-NFC, I think it will soon be time to talk about the anomaly on the East face again; I'm bringing it out of the closet and reproducing below a few elements of what had been announced. As I'm well acquainted with the architectural and constructive mindset of the designers, Hemiunu and Ankh-haf, I wouldn't be surprised if they'd had an idea about this area of the pyramid that lay within the enclosure of the Upper Temple.



In this photo, showing what remains of the basalt paving of the Upper Temple of the Khufu Pyramid, the limestone blocks where a significant thermal anomaly was detected are surrounded by a yellow circle.

Given their proximity to the Temple, it's not unreasonable to think that their location could have something to do with it.

²⁰² November 1 to 12, 2015.

²⁰³ By Clemente Ibarra-Castadena.

²⁰⁴ "The usual suspects".

²⁰⁵ Even for urinary reasons!

STRABO'S PORTCULLIS CHAMBER



Position of the microbolometer camera 50m from the East face.
The anomaly detected is inside the blue rectangle.

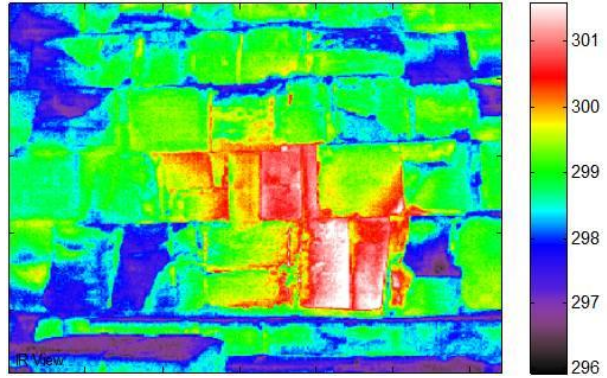

IR, November 4, 2015, 04:42 (before sunrise), microbolometer camera, photo lens, 50 m from the East face.



Close-up of the masonry, visibly altered, in the area where the anomaly was detected.

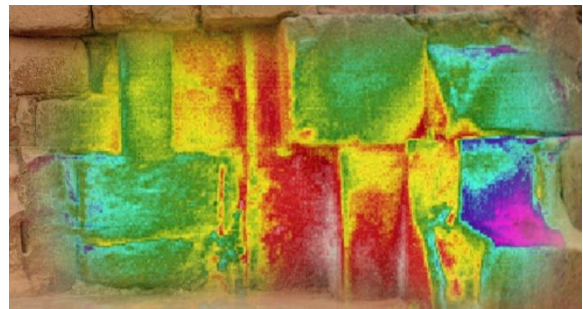

3D reconstruction of infrared information applied to the image on the left.

In a report submitted by the Laval University team and Jean-Claude Barré to ScanPyramids at the time, certain clarifications were made:

"Thermographic images showing a view of the East face of Khufu's Pyramid, from different distances as indicated. Similar images were acquired at different times²⁰⁶ of the day (early morning, noon, night) to verify if this thermal signature was not the results of optical or thermographic artifacts (direct solar irradiation, environmental reflections, etc.). The difference in temperature was noted at all times and it covered approximately the same area with thermal gradients of 1°C or more depending on the time of the day, which lead us to the conclusion that this particular feature is of great interest for further study and could potentially correspond to a subsurface anomaly (a cavity, a corridor, stone restoration, etc.). Alternative non-destructive techniques (muons radiography, radar, etc.) could help to gain more information about its nature".

The negative reception of the anomaly announcement and, above all, the discovery, at the same time, of the second anomaly in the entrance rafters, put an end to any further research into this anomaly.

Now, given the importance of air leakage in the detection of an anomaly by thermography that has been highlighted with SP-NFC, the likelihood that a void²⁰⁷ could be behind the masonry remodeling in this area is greatly enhanced. This will be discussed later in this Memoir.

²⁰⁶ A thermogram is an evaluation of temperature measurements on a wall in a three-dimensional space, length, width and height; to this we must add a fourth dimension which is Time. This will be discussed later in this Memoir.

²⁰⁷ In the form of a simple corridor, given the size of the blocks and the width and height assigned.

STRABO'S PORTCULLIS CHAMBER

Infrared thermography to detect anomalies on the rafters on the North face.

In parallel with the investigations on the East face, others were undertaken on the other faces of the pyramid, but one area on the North face immediately caught the attention of infrared specialists: the area of the rafters above the entrance.



Close-up of the rafters at the North face entrance.

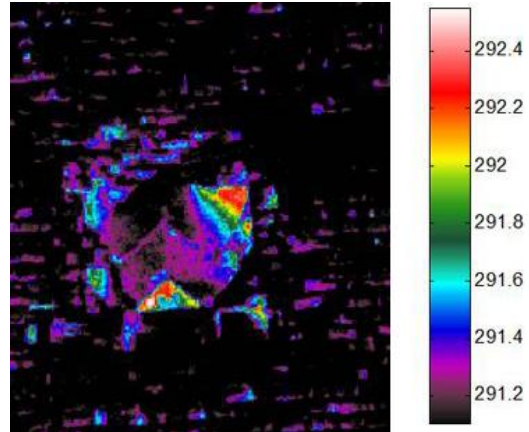

IR, November 4, 2015, 05:52 (before sunrise), cooled camera, photo lens, 175 m from the North face of the Pyramid (rain color map).

In the same report cited above, it was stated that:

"Facing the rafters on the North face: 2 hotter areas detected. Distance 5 meters. 10:00 a.m."



Close-up of Strabo's Stone.

The part with the "notches" is not in contact with the rafters, and may be in contact with a cavity.
(As a reminder, the endoscope used to visualize the second chamber was introduced through an interstice).

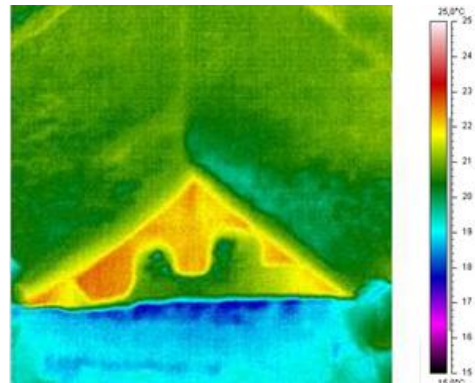

Detail of the Stone, one of the 2 hottest zones detected and indicated in the internal report.

Air circulation between indoors and outdoors was one possibility.

And more:

"An unusual asymmetry is observed between corners of the herringbone shaped stones, which should normally be at the same temperature, given that this area is never directly exposed to the sun. Nevertheless, a higher temperature was systematically measured at the top right corner at every time of the day that was verified (early morning, day and night)".

STRABO'S PORTCULLIS CHAMBER

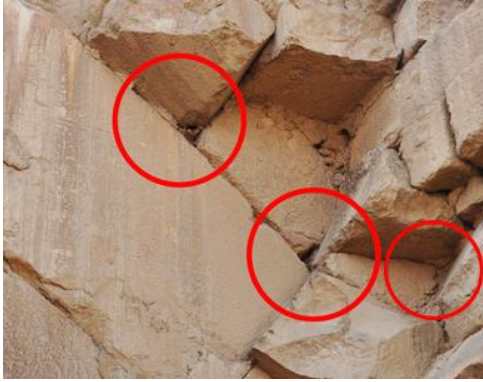

Details of the top corner of the top right rafter. In the red circles, points of origin of probable leaks.

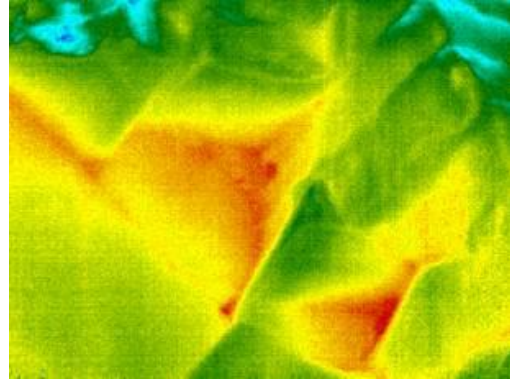

Details of the upper corner of the top right rafter, the second warmer zone detected, with the points of origin of probable air circulations between inside and outside.

Another area showing the same peculiarity is the upper corner of the top left rafter.

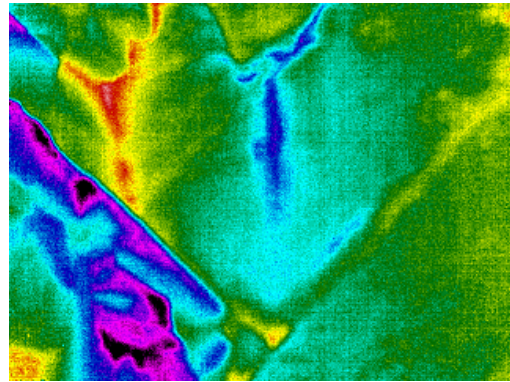

Last point in the report:

"The average temperature of the stones in this thermogram was 21°C. There are signs of surface runoff areas (black, purple) with a temperature around 16.5°C. These areas appear very clearly around the vertex of the rafters. The exact origin of this water marks is to be verified at an upcoming survey: either from underneath the stones, which would show a possible cavity, passage, hollow area, or simply water runoff from above. It should be noted that all the gaps that should normally be colder, are actually warmer with a minimum of 22°C for an outdoor temperature of 17°C".

A second infrared mission will be carried out by the Laval University team in June 2016, with the aim of recording long-term data. With the camera installed in a tent, two consecutive 24-hour acquisition sequences were carried out at a distance of 175 m and a third at a distance of 100 m from the North Face.



View of the tent positioned 175 m from the North face, the infrared camera and the calibration plate installed in its field of view.

STRABO'S PORTCULLIS CHAMBER

The reason for the calibration plate was to have a permanent reference for comparing the different temperatures measured at points of interest in the rafters and tourist entrance area.

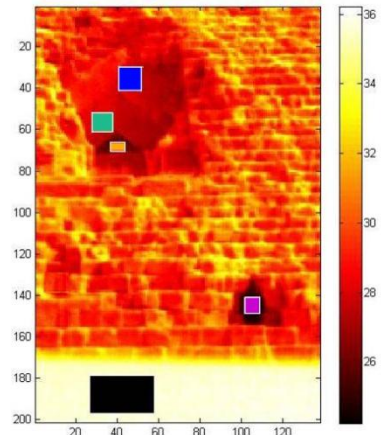
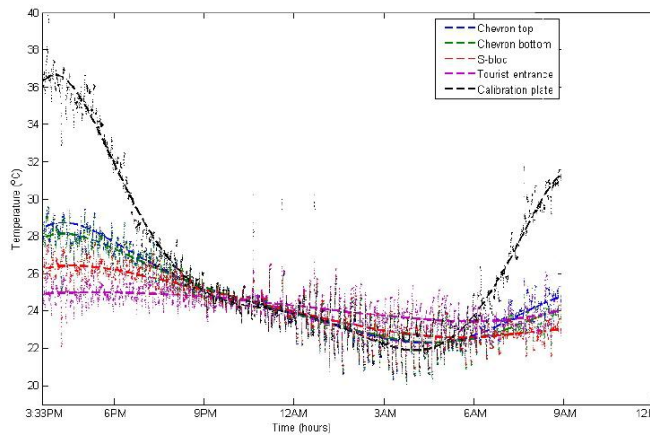

Temperature profile :
 - in navy blue, upper rafters,
 - in green, the lower rafters; in orange, the Strabo Stone; in magenta, the tourist entrance; and in black, the calibration plaque.

Location of the temperature profiles recorded :
 - The colors of the lines in the diagram on the left are representative of the temperatures recorded in the areas indicated by the colored squares.

Here are a few observations following these sequences.

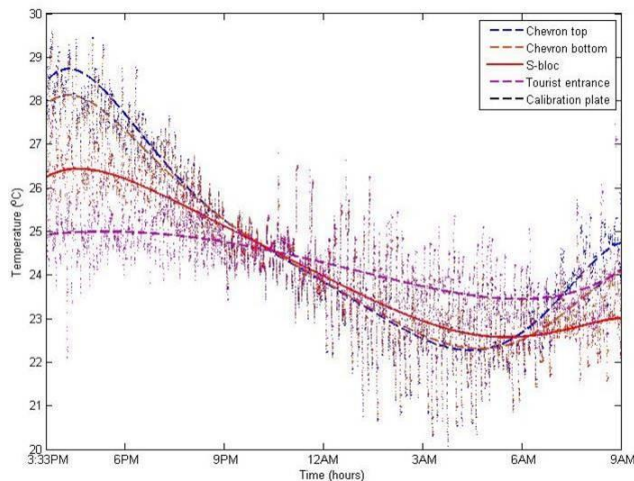

- The upper rafter (blue profile) is always warmer or at the same temperature as the lower rafter (green profile).
- The Strabo stone (orange profile) goes from colder to slightly warmer than the chevrons during cooling.
- The temperature at the tourist entrance (magenta profile) is almost constant, as expected.

Note also that in the two diagrams on the left, the Stone curve is always flatter than the chevrons and closer to the tourist entrance curve, whether above or below it. The cooling and warming of the Pierre are more in line with the influx of tourists, especially the warming.

That said, following the discovery of this second anomaly in November 2015, it had been decided to use muography to try and detect a possible cavity located behind the rafters; this could then have an influence on the thermal behavior of the limestone blocks in the rafters area, through possible leaks for example.

In early December 2015, the Nagoya University team installed eighty plates with emulsion film in the Bent pyramid at Dahshur²⁰⁸ for a period of forty days. Collected in January 2016, the films will be taken to the GEM laboratory²⁰⁹ to be developed and then fixed. At the beginning of February, they will be sent to Nagoya University for scanning with an ultra-fast microscope. The collection of muons will confirm that muography was capable of detecting voids in a pyramid. This will take over from infrared in the mission at Khufu's pyramid in June 2016. This muography mission to the chevrons zone is the subject of the rest of this chapter.

²⁰⁸ According to the schedule drawn up when the Egyptian authorities issued the permits.

²⁰⁹ Grand Egyptian Museum in Giza.

STRABO'S PORTCULLIS CHAMBER

Muography to look for a cavity behind the rafters.

Between January and March 2016, a first calibration test mission was carried out by Dr. Morishima and the Nagoya team with the installation of three emulsion plates in the descending corridor, between the ascending corridor and the original entrance. The aim was to test the exposure time²¹⁰ possible in the particular environment of the interior of the Khufu pyramid. In the subsequent processing of the plates, the chevron zone behind the hole above the descending corridor was clearly visible, as was an unexpected accumulation of muons behind this zone.

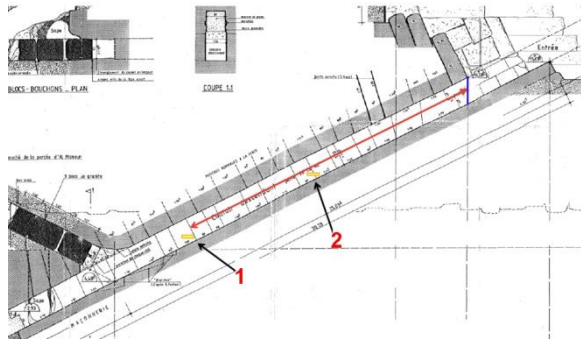

Sectional drawing by Gilles Dormion

Position of test plates during calibration :
1 - data recorded from January to March 2016,
2 - data recorded in March and April 2016.



Photo of test emulsion plates installed in the descending corridor during missions from January to April 2016.

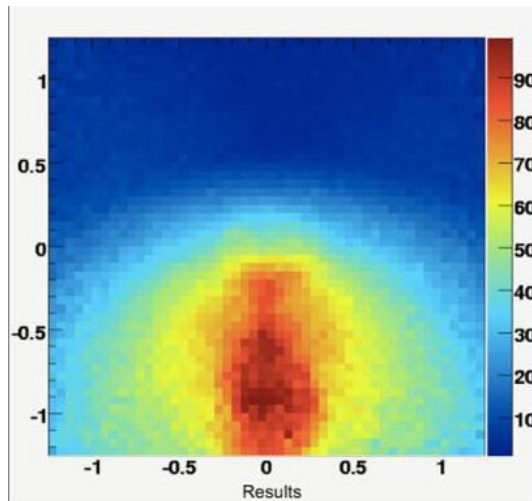

The first muography result from an emulsion plate calibration test.
The anomaly detected was not sufficiently conclusive to be considered valid.

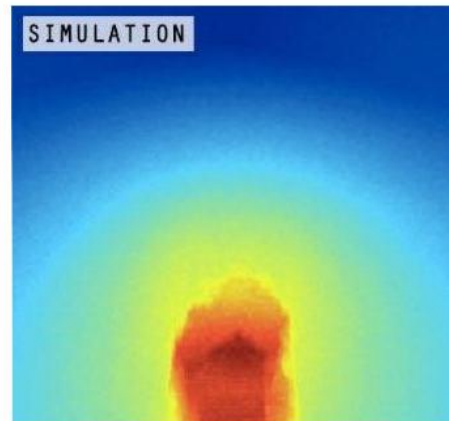

The first simulation²¹¹ of the existing structure in the rafter area.

A second test mission, carried out in March and April, confirmed a minimum film exposure time of over forty days.

On June 1st, the official muography mission in the Khufu Pyramid got underway with the installation of three plates representing a surface area of 0.75 m², in the descending corridor. On August 7, after sixty-seven days on display, they were taken back by the Nagoya team, who found them to be in good condition.

²¹⁰ As the technique was experimental, the exposure time of the plates was still the subject of much attention. This period was to increase rapidly thereafter.

²¹¹ With the software developed by Benoît Marini.

STRABO'S PORTCULLIS CHAMBER

After processing the data in Japan, at a workshop in Paris on September 14th, the Nagoya team presented the ScanPyramids team with the first results showing the presence of a notable anomaly. Comparison with a 3D simulation of the entrance showed that the three plates had each revealed an excess of muons well over 5 sigma²¹² which validated the discovery of a void behind the rafters on the North face.

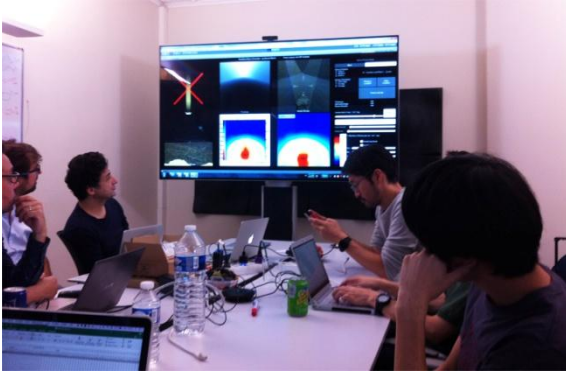

Presentation, on September 14, 2016, of the first results of the processing of the plates surveyed on August 7 at a workshop held in Paris.



At this meeting, Jean-Baptiste Mouret, a robotics specialist at INRIA²¹³ Strasbourg, presented a prototype of an inflatable airship that could be introduced into a cavity through a 3cm diameter borehole, with a view to possible exploration.

On October 15, 2016, the ScanPyramids mission issued a press release announcing the discovery:

“Having conducting those three complementary techniques, we are now able to confirm the existence of a “void” hidden behind the North Face, that could have the form of at least one corridor going inside the Great Pyramid. The precise shape, size, and exact position of this void is now under further investigation. It should be done with the help of 12 new Muon Emulsion plates that are installed in the descending corridor, and will be collected by the end of October 2016”.

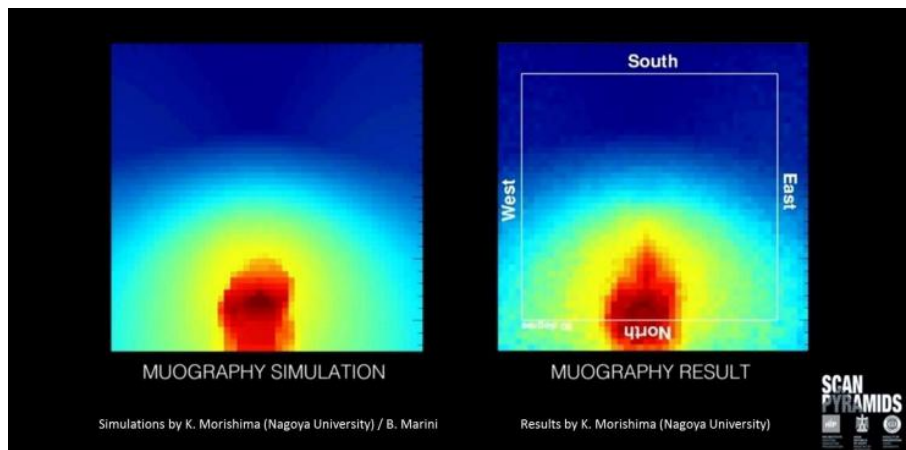

On the left, a simulation of the existing structure, on the right the result of the muography.

²¹² In other words, 99.9999% validation of the anomaly detected.

²¹³ INRIA - Institut National de Recherche en Sciences et Technologies du Numérique www.inria.fr/fr

STRABO'S PORTCULLIS CHAMBER



The announcement was accompanied by a 3D model showing a "points cloud" indicating the position of the detected anomaly. After careful consideration, the ScanPyramids team decided not to commit to any particular form.

The conclusion was:

"The ScanPyramids team is also completing the investigations by 3D simulation of different architectural hypotheses, with the aid of Muography simulators".

In fact, for nearly a month, the²¹⁴ team had been studying several hypotheses for simple volumes that could be used to imagine the type of cavity that would eventually be discovered.

I reproduce two examples below.

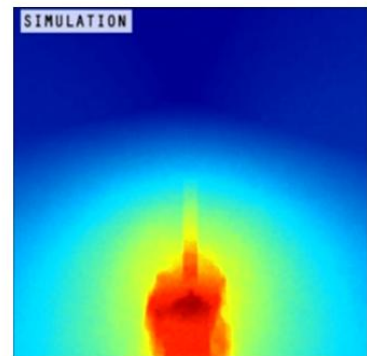
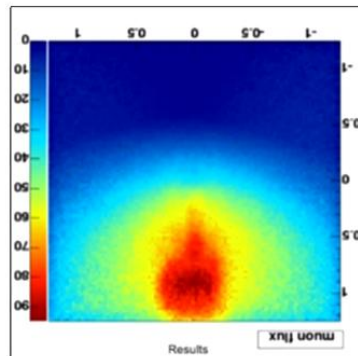
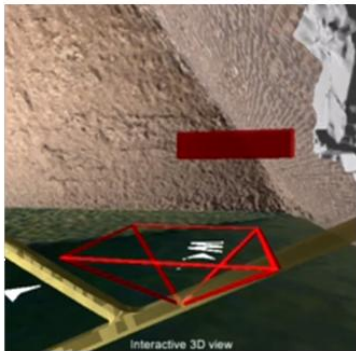

Hypothesis of a corridor (2 m high, 1.3 m wide) behind Strabo's Stone...

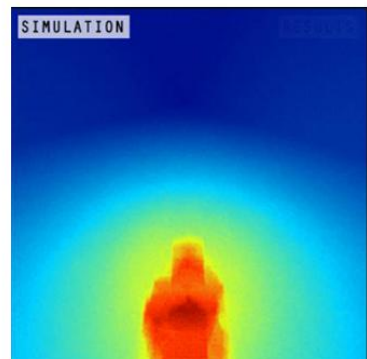
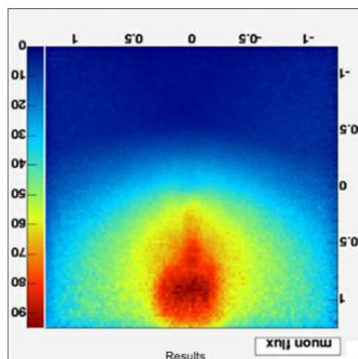
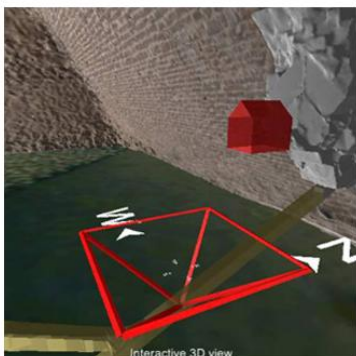

Assumption of a 2.9 m x 3.7 m room with a roof formed by the upper rafters.

²¹⁴ Benoît Marini, Pierre Gable and myself.

STRABO'S PORTCULLIS CHAMBER

At the same time, still very confident about "FUNCTION", I studied various possible "FORMS" in the light of the initial muography results. In the example below, based on Gilles Dormion's plans and cross-sections, I imagined a shorter entrance room²¹⁵ which did not change the function of the room. It did, however, pave the way for the reconstruction of the second entrance room, which will be the subject of the following chapter, with the technical choices made by the designers in mind.

Details of the layout of the five sets of sketches below:

- on the left, top, longitudinal section of the short entrance room with the second ascending corridor.
Note: the second horizontal corridor is not shown,

- bottom left, floor plan,

- on the right, sketch on the left, cross-section behind the Lower rafters in the vertical well, before the Separating wall, reserved for the Strabo Stone ("S" Block); from the third series of sketches onwards, the cross-section in the well is replaced by a front view of the entrance rafters,

- on the right, right-hand sketch, cross-section through the room behind the partition wall, in which counterweights are arranged laterally on either side.

Configuration during construction of the pyramid.

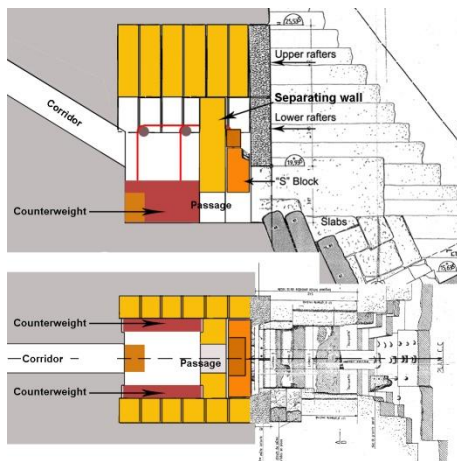

Configuration during construction of the pyramid.

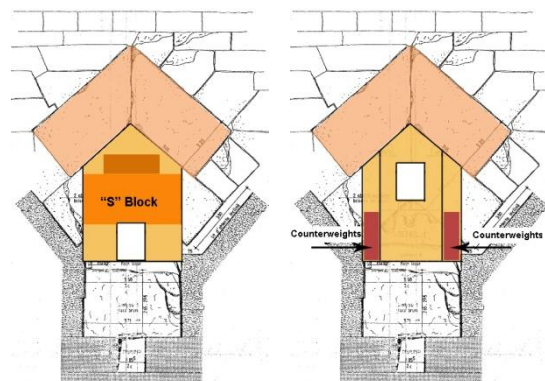

The room is divided into 2 unequal parts by a dividing wall: the front part resembles a vertical well in which the Strabo Stone is suspended, while the longer rear part houses the lateral counterweights, which rest on the floor. Ropes running on logs connect the latter to the Stone.

A few more blocks have been sealed onto the stone.
A passageway is reserved at the bottom of the dividing wall.

Left: Strabo's Stone is held up in the vertical well between the lower rafters and the wall dividing the room into 2 sections. At the bottom is the passageway into the second section.
Right: The side counterweights are in the lowered position, the entrance to the ascending corridor of the Noble Circuit is at the top of the wall at the far end of the room.

²¹⁵ About five meters long, instead of the almost eight meters of the 2011 Noble Circuit.

STRABO'S PORTCULLIS CHAMBER

Sealing access to the Noble Circuit after the funeral:
1st operation.

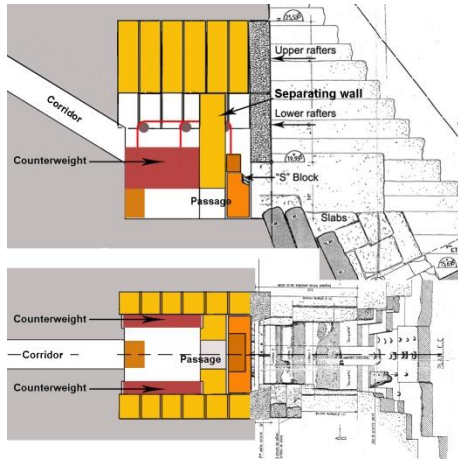

Strabo's Stone, now dubbed as "Strabo's Portcullis", has been lowered, the maneuver being carried out by a few workers and slowed down by the counterweights of the rear part, which are now in the upper position.

Sealing access to the Noble Circuit after the funeral:
1st operation.

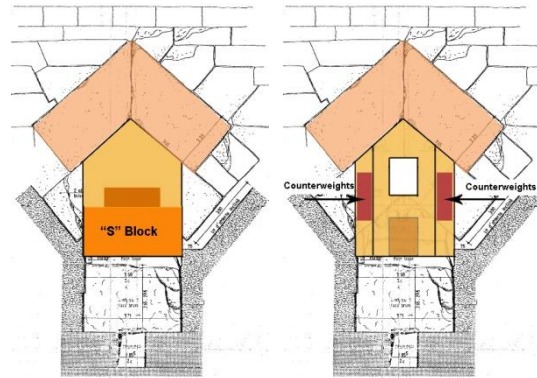

Left: Strabo's Stone has been lowered into the vertical well.
Right: The side counterweights are in the up position,

Sealing access to the Noble Circuit after the funeral:
2nd operation.

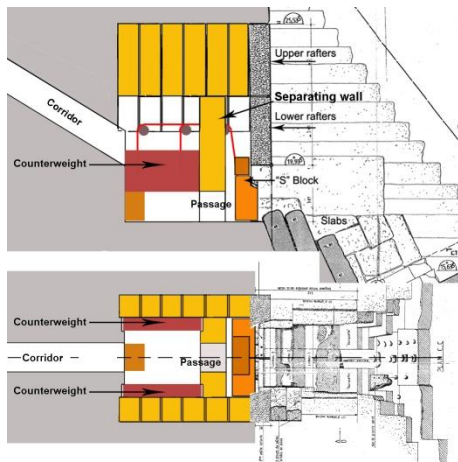

Strabo's Portcullis" was pushed some 20 cm below the lower pair of rafters to prevent it being lifted by grave robbers. A block for sealing the passageway is waiting at the back of the rear room.

Sealing access to the Noble Circuit after the funeral:
2nd operation.

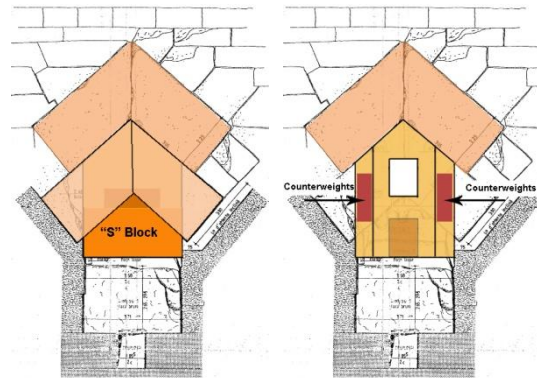

Left: The "Strabo Portcullis" is now in its current position.
Right: The counterweights are up.
A block for sealing the passageway is waiting at the back of the rear room.

STRABO'S PORTCULLIS CHAMBER

Sealing access to the Noble Circuit after the funeral:
Last operation.

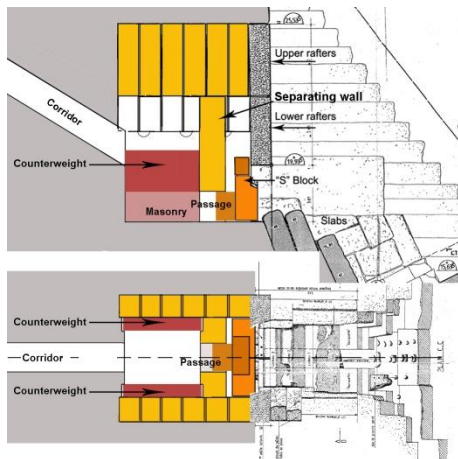

The sealing block for the passageway was placed against the stone, and masonry was laid under the counterweights to hold them in place.

The ropes and logs of the system have been removed, and the sealing is complete.

Sealing access to the Noble Circuit after the funeral:
Last operation.

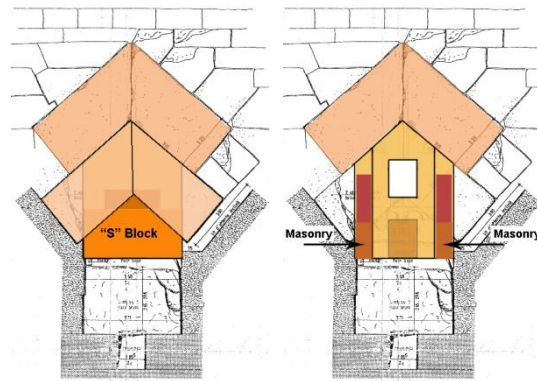

Lateral counterweights and the masonry under each reduce the width of the rear room to around 2.60 m, for a height of less than 5 m below the roof peak and around 4 m on the sides. The maximum void length, including the upper part of the well and the rear room, is around 4.10 m,

The point of this study was to demonstrate that the function could be achieved in the small volume that seemed to have been detected by the muons - that's what architecture is for, whatever the era. In making this one, I realized that the Egyptians may have been more astute than I had imagined; in the version of the second entrance chamber presented in January 2011, given the weight of the Strabo Stone, I found it hard to imagine that it could have been "lowered" by a small team assigned to sealing the entrance after Khufu's funeral. I therefore opted for a solution that allowed the Stone to be stored on rollers at the back of the entrance chamber. After the funeral, the Stone was pushed into its final position under the rafters by a small team, as its weight posed no problem.

In the introduction to the presentation of this study, I wrote:

"It did, however, pave the way for the reconstruction of the second entrance room, which will be the subject of the following chapter, with the technical choices made by the designers in mind".

As of September 2016, the three major contributions were as follows:

- The storage of Strabo's Portcullis in a vertical well for total protection²¹⁶,
- The idea of lateral counterweights to slow the lowering of Strabo's Portcullis,
- The push of Strabo's Portcullis only runs about twenty centimeters.

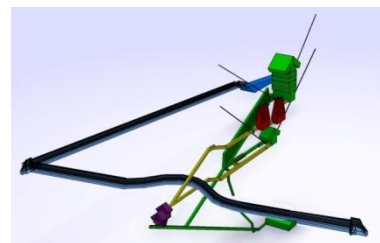
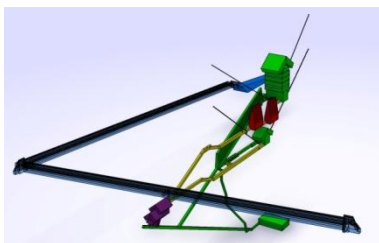

Having said that, I was convinced that the second chamber was much longer than the five meters envisioned, as it would not have been in keeping with the logic of allowing passage of the internal ramp, nor with what microgravimetry revealed an overdensity that went far beyond the latter. The sketch on the right highlights an idea that the Egyptians would never have imagined.

²¹⁶ This is in stark contrast to the Portcullis Chamber at the entrance to the King's Chamber.

STRABO'S PORTCULLIS CHAMBER

The Nagoya team's mission continued throughout 2017 with several detection campaigns, ScanPyramids having two objectives:

- the first, to reconfirm at more than 5 sigma the existence of this cavity from different positions, in the descending corridor and in the small niches of the al-Ma'mun tunnel,
- the second, to view it from different angles in order to refine its shape, its distance from the face of the rafters and its height from the pyramid floor.

On September 9, 2019 ScanPyramids presented the Egyptian Authorities with a scientific report outlining the history of actions and results achieved between the announcement of the discovery of an anomaly behind the chevrons on October 16, 2016 and the end of 2017. It was at this time that this anomaly, confirmed at over 5 sigma, had been officially dubbed SP-NFC for *ScanPyramids North Face Corridor*.

Here are the most important points from the report:

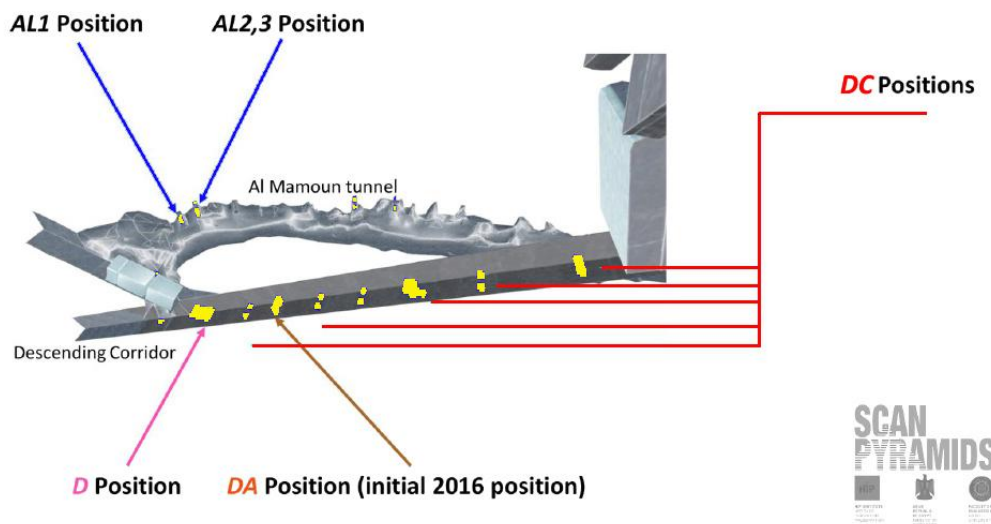

3D modeling of plate positions set up during 2017 and processed before the report was published.

Positions legend:

D Position (2017): 9 plates – 73 days exposure time, they confirm with enough statistics the existence of the cavity too

DA Position (2016): 3 plates - 67 days exposure time that have confirmed the cavity in October 2016.

DC Position (2017): 12 plates – 63 days exposure time, they confirm with enough statistics the existence of the cavity.

AL1, AL2 et AL3 Positions (2017) : 5 plates – 66 days exposure time, Not enough statistics (non optimal orientation) but can be combined with other positions for slope refining

STRABO'S PORTCULLIS CHAMBER

The report's conclusions were as follows:

"The new muography campaigns have enabled the ScanPyramids team to reconfirm, at over 5 sigma and from different viewpoints, the existence of the SP-NFC and to refine by triangulation the position and dimensions of this cavity, which appears to resemble a corridor.

Through DA and DC positions statistical analysis, we can conclude:

Distance from pyramid face: 0.7 m to 2 m

Localization from pyramid's ground: 17m to 23m

Height: 1 m to 3 m

Width: 1 m to 2 m

Length: 5 m minimum

(We succeeded to detect the 5 first meters. The density of the pyramid is too high after 5 meters and the number of non-absorbed muons is lower, the exposure time is not enough to see after 5m, the muons plates can only be exposed for 80 days, then they are damaged by the temperature and humidity conditions)

Slope: Horizontal or ascending slope. Muographs from the niches in the Al-Mamun tunnel have ruled out the hypothesis of a corridor parallel to the descending one.

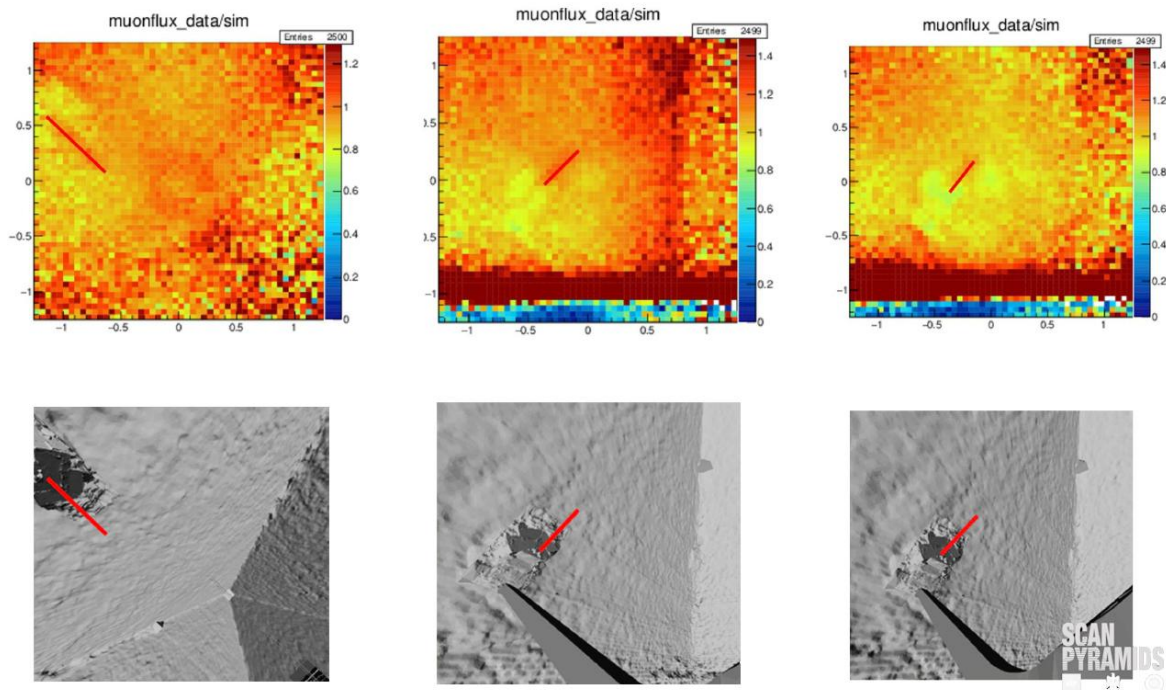

Results of the emulsion plates in the niches of the al-Ma'mun tunnel, from left to right AL2, AL1 and AL3 :
- above, muon flux data highlighted in red,
- below, the position of the red lines in a digital model.

STRABO'S PORTCULLIS CHAMBER

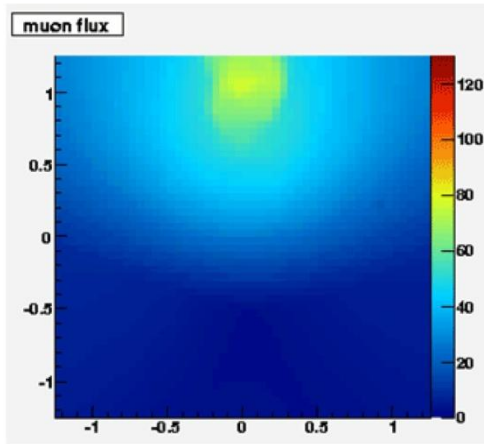

Simulation of the area behind the rafters before the discovery of SP-NFC.

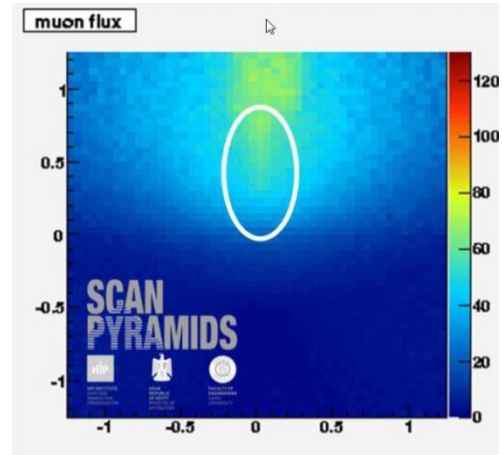

Confirmation of a corridor 1m to 3m high, 1m to 2m wide and at least 5m long. The slope is either horizontal or ascending.

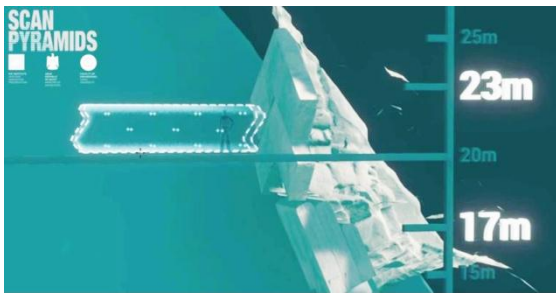

The corridor would be located at a height of between +17m and +23m from the base of the pyramid.

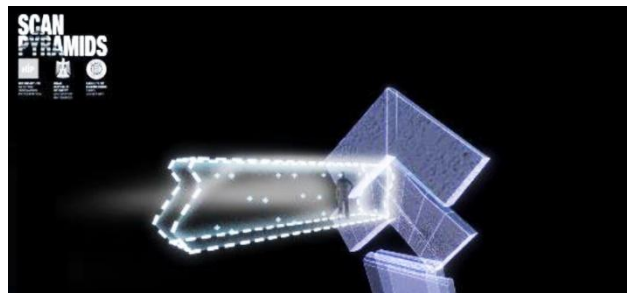

A horizontal version of the detected SP-NFC corridor. This position places the top level of the corridor at the level of the underside of the junction of the right and left high rafters.

The report concluded with a chapter entitled *Perspectives*:

"We do not yet know how far SP-NFC penetrates inside the Great Pyramid and it is difficult to discern if the two discoveries (SP-NFC and SP-BV²¹⁷) are connected to each other. We know that they are located on the same vertical plan as all of the pyramid's known architectural structures (corridors, Grand Gallery, Queen's Chamber, King's Chamber)".

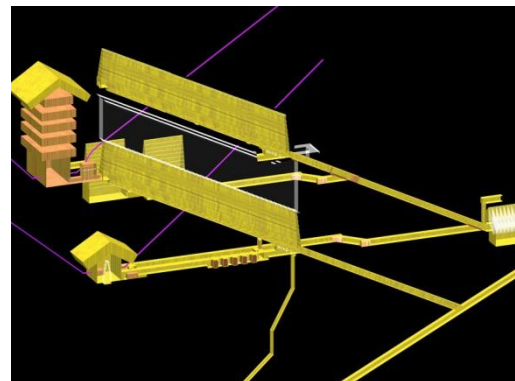
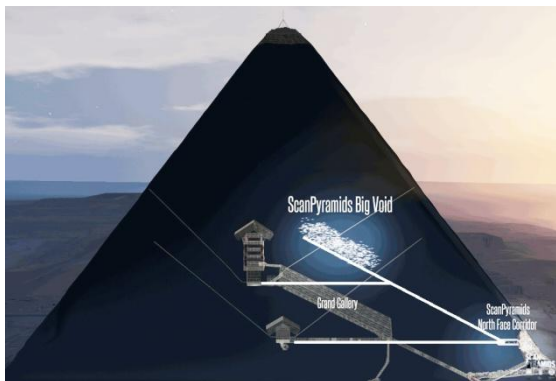

For me, the answer was already obvious just by drawing three white lines (left image), having had this probable interior architecture in my "head" for several years (right image). Since then, the official discovery of SP-NFC has provided a major answer to this question!

²¹⁷ See Memoir The BIG VOID.

STRABO'S PORTCULLIS CHAMBER

Subsequently, in 2018 and 2019, new emulsion plates were installed in the niches of the al-Ma'mun tunnel, and additional data were also extracted from the many plates already impressed by muons. In the same report of September 9, 2019²¹⁸, the progress of muography on SP-NFC up to that date was also reported:

"All the data extracted from the emulsion plates positioned in the Al Mamun's corridor and the descending corridor confirm the existence of SP-NFC at a confidence level higher than 5 Sigma.

A new triangulation has been performed by combining all the positions data analysis, confirming our 2017 position estimation. Al Mamun's plates data interpretation let us think that SP-NFC should be horizontal, but the error bar is still large, and we need to continue the analysis in order to increase our confidence level.

We will, in October, move the CEA's telescopes inside the descending corridor. Our objective is to reinforce Nagoya University conclusions with another muography technique.

Other non-destructive techniques (Radar and micro-gravimetry) allowing us to "scan" the area should help us to refine the exact position and help us to drive us to a conclusion about SP-NFC slope".

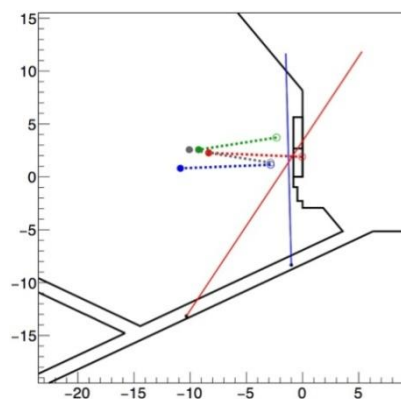

The report was illustrated by a diagram showing the likely positions of the SP-NFC. The red and blue horizontal lines began to provide details that were closer to the reality announced on March 2, 2023.

The report concluded:

"ScanPyramids North Face Corridor (SP-NFC):

- *SP-NFC detected in 2016, has been reconfirmed in 2017, 2018 and 2019.*
- *SP-NFC is likely horizontal and new non-destructive techniques should be used to refine the exact South position and the exact distance from the North Face chevrons.*

CEA's team has been asked to detect SP-NFC with their telescopes positioned in the descending corridor".

Unfortunately, something big happened: on March 11, 2020, the WHO²¹⁹ the outbreak of COVID-19²²⁰ that appeared in November 2019 in China is declared a pandemic, putting the planet on hold for more than two years, and upsetting the pace of ScanPyramids' investigations²²¹.

²¹⁸ See Memoir The BIG VOID, from page 85 to page 99.

²¹⁹ World Health Organization.

²²⁰ See Memoir The BIG VOID on page 49.

²²¹ This made it even more difficult for me to follow up on the mission.

STRABO'S PORTCULLIS CHAMBER

That said, the CEA still managed to continue its mission during this period with telescopes placed in the descending and ascending corridors, these positions allowing several viewing angles of the SP-NFC to determine its length more accurately.



Sébastien Procureur (blue T-shirt) and the CEA team will position the Degennes, Charpak and Joliot telescopes inside the pyramid to investigate the SP-NFC.



Transferring the telescopes inside the pyramid and positioning them in the descending and ascending corridors is certainly not an easy operation.

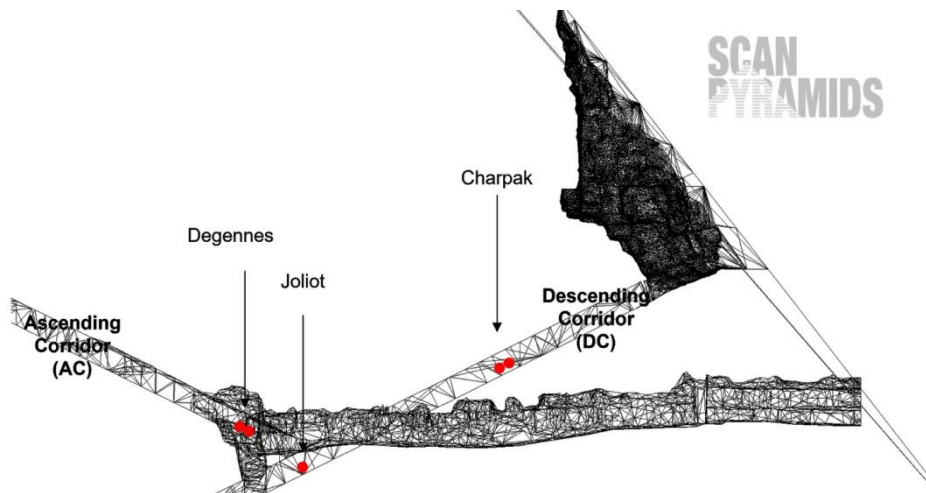

Positions of the three telescopes in the descending and bottom ascending corridors.

Following the acquisition of new data by the CEA team until 2020 and the processing of data acquired by the Nagoya team until October 2019, the two teams filed a joint paper on the results of their investigations on September 22, 2021²²² in the journal *Nature Communications* under the title:

Precise characterization of a corridor-shaped structure in Khufu's Pyramid by observation of cosmic-ray muons²²³

Sébastien Procureur, Kunihiro Morishima...

²²² Accepted on January 26, 2023 and published online on March 2, 2023.

²²³ Procureur, S., Morishima, K., Kuno, M. *et al.* Precise characterization of a corridor-shaped structure in Khufu's Pyramid by observation of cosmic-ray muons. *Nat Commun* **14**, 1144 (2023).

<https://doi.org/10.1038/s41467-023-36351-0>

STRABO'S PORTCULLIS CHAMBER

I quote below a few extracts and diagrams from this document to show the exceptional quality of the results obtained after several years of effort and improvements to investigative equipment, emulsion plates and telescopes, that this mission entailed.

In the part of the article concerning the Nagoya University team, we read, among other things:

"Fig. 5: Results of the analysis of the nuclear emulsion film by Nagoya University.

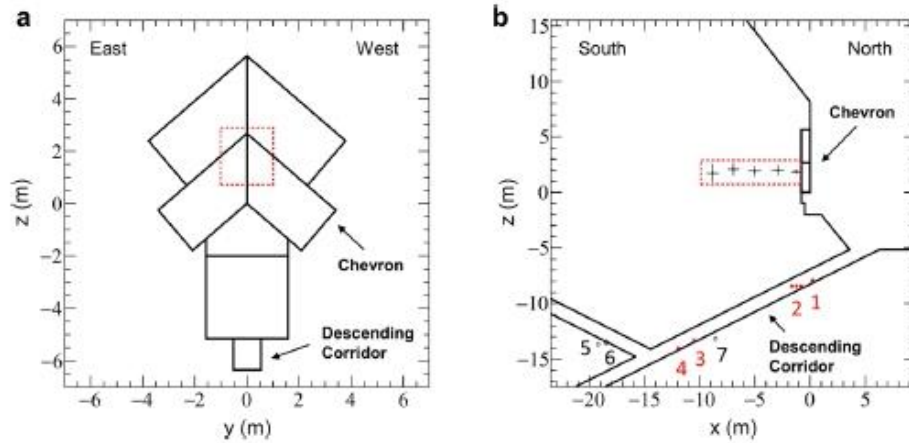

The location and shape of the NFC are shown in cross-sectional views of the analysis area including the Chevron from the North (a) and East (b) sides. The locations of EM1 to EM4 detectors installed in the DC and obtained results are shown in red, and EM5 to EM7 installed in the MC are shown in black, respectively in b. The red dotted line is the projection of the location and shape of the NFC defined as a rectangular cuboïd achieved by EM1 to EM4. Black dots are the projection points in the height obtained by detectors (EM5 to EM7) on planes and error bars, which are the standard deviations of the averaged projection points in the x and z directions, as shown in figure 4d".

In the part of the article concerning the CEA team, we read, among other things:

"The measurement campaign started in October 2019 with the installation of three telescopes in the DC and on a dedicated wooden platform built at the intersection between the DC and AC (Fig. 2b, f-h). The middle telescope (called Joliot) had an active area of $50 \times 50 \text{ cm}^2$, while the other two (Degennes and Charpak) were made up of two parts, resulting in a surface of $100 \times 50 \text{ cm}^2$ each. The excellent spatial resolution of the detectors, of the order of $200 \mu\text{m}$, yields an angular resolution around 1 mrad only yet with very compact instruments to fit in the DC.

.../...

All in all, the telescopes acquired about 140 days of stable data (Methods), collecting more than 116 millions of muons. The corresponding five instruments (1 + 2 + 2) were treated independently in the analysis.

STRABO'S PORTCULLIS CHAMBER

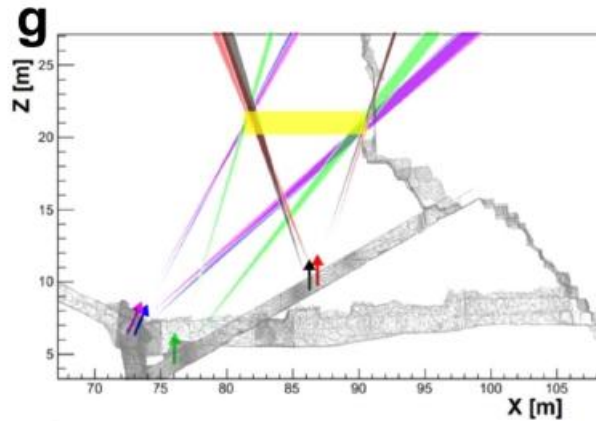

Fig. 7: NFC signal and triangulation from CEA data (Extract).

g Triangulation of the NFC using the five instruments, where each cone represents the extremity of the NFC found in one dataset (i.e. the directions defined by the red lines in plots (d-f)). The width of each cone represents the uncertainty of its direction, i.e. from 0.5 to 1.5°. The arrows show the orientation of each instrument. The yellow rectangle represents the position and size of the NFC as determined from the CEA analysis. The position of each telescope is shown on page 71.

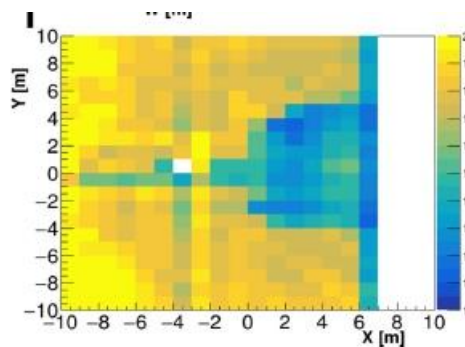

Fig. 8: Determination of NFC characteristics from CEA data (Extract).

i Integrated density distribution (in g/cm^3) obtained between $Z = 19.5 \text{ m}$ and $Z = 23.5 \text{ m}$ using the SART algorithm as described in the text. The Chevron shape is correctly reconstructed as well as the NFC position, without any geometric input.

"While the above analysis relies on a somehow arbitrary assumption that the NFC has a parallelepiped shape, this assumption is well supported by comparison with the simulation implementing the fitted NFC, where the local excesses attributed to the NFC largely disappear (Fig. 7h-j). However, it's worth mentioning that other shapes are compatible with the data, and the chosen parallelepiped only represents the simplest possible form. If the real shape is more complex (e.g. with a Chevron structure on the ceiling), the obtained mean dimensions obtained wouldn't change. Lasy but not least, a southwards continuation of the NFC with a smaller transverse section cannot be ruled out with the current statistics, but simulations showed that it should then be smaller than $1.0 \text{ m} \times 1.0 \text{ m}$ to remain unseen by our instruments."

Finally, in the section common to both teams, Discussion:

"The results presented in this work were obtained by two teams using different muon detectors and independent analyses. As can be seen in Table 1, all the NFC parameter estimates are well compatible within error bars, and the previously discovered NFC was measured with excellent sensitivity. North end of the corridor starts 0.8 m behind the Chevron and ends 9.1 m southward. A horizontal corridor is favored, with a transverse section around $2.0 \text{ m} \times 2.0 \text{ m}$. More complex shapes than a simple parallelepiped are possible, but with the same mean height and width. To our knowledge, this study is the first characterization of the position and dimensions of a void detected by cosmic-ray muons with a sensitivity of just a few centimeters. On the archaeological side, the discovery of a void located behind the Chevron and having a larger cross-section than the corridors

connecting the inner structures of the pyramid may be decisive in approaching the role of this Chevron. Last but not least, the NFC does not seem to connect to the SP-BV, though a smaller corridor of <1.0 m between these two structures cannot be completely ruled out from these measurements."

To sum up in a few figures, the muography indicated a horizontal corridor starting at the back and top of the low rafters with a cross-section of approx. 2 m x 2 m and a length of approx. 9.10 m. A smaller corridor²²⁴, possibly linked to the BIG VOID, could not be ruled out.

Radar and ultrasound come into play.

The ScanPyramids mission will also succeed in implementing the new non-destructive techniques envisaged in the 2019 report, radar and ultrasound, with the arrival in 2020 of the Technical University of Munich²²⁵ This German mission will be under direct coordination of the Cairo Faculty of Engineering²²⁶ on behalf of the ScanPyramids mission. As a result, although I was informed that the latter was active on the Khufu Pyramid, I was not personally able to follow developments on this mission.

That said, on March 2, 2023, the day of the announcement of the discovery of the second Entrance Chamber, in coordination with the publication in Nature Communications of the muography results discussed above, a second article will be published in the scientific journal NDT & E International - ELSEVIER under the title:

Localization and shape determination of a hidden corridor in the Great Pyramid of Giza using non-destructive testing²²⁷

Mohamed Elkarmoty, Johannes Rupfle ... Hany Helal

I also quote below a few lines and diagrams from this document by the team at the Technical University of Munich, who also provide proof that the future of archaeology will be intimately linked to the state-of-the-art non-destructive technologies that are increasingly available.

" 2. Data acquisition and processing

The measurements were performed in three campaigns in November 2020, February 2022 and October 2022.

.../...

2.1. Ground-penetrating radar

GPR²²⁸ is a geophysical survey method based on the transmission and reflection of electromagnetic waves. It is commonly used in cultural heritage sites investigations and for structural evaluation. Electromagnetic pulses are reflected by fractures, joints or sub-surface layer boundaries such as voids. Reflections are recorded in a radargram at a two-way time scale that indicates the depth of reflections. This travel time can be converted to depth values, as long as a representative dielectric constant of the medium or an average propagation velocity can be determined. The frequency of the electromagnetic waves affects the resolution of the data and the penetration depth.

²²⁴ The section of standard corridors in the pyramid.

²²⁵ The team includes geophysicist Johannes Rupfle and Christian Grosse, Chair of Non-Destructive Testing at the University of Munich.

²²⁶ Under the direction of Pr. Hany Helal and Mohamed Elkarmoty.

²²⁷ Mohamed Elkarmoty et al, *NDT&E International*, <https://doi.org/10.1016/j.ndteint.2023.102809>

²²⁸ Ground Penetrating Radar

.../...

2.2. Ultrasonic testing

UST techniques as they are applied to civil structures depend strongly on the materials, construction details and geometries of the involved components. UST measurements²²⁹ at the pyramids are particularly challenging because of the large thickness of the limestone blocks, the joints between them, and the deterioration of the surface of some of the blocks.

.../...

2.3 Image fusion

The goal of image fusion is to combine two or more images into a single composite image that contains information from all individual images [22]. The objective of this work was to determine if image fusion can be applied in a culture heritage special case of a heterogeneous medium and if it can improve the interpretation of imaging results by providing information from two modalities, i.e. GPR and UST, in one single image.

.../... "

I've reproduced two diagrams for the precision of the results obtained by combining the three techniques used.

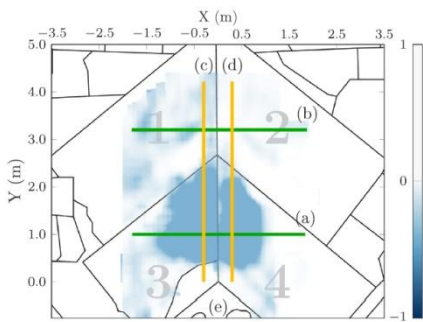

Figure 6: View of the chevrons and the position and depth of the anomaly detected by penetrating ground radar

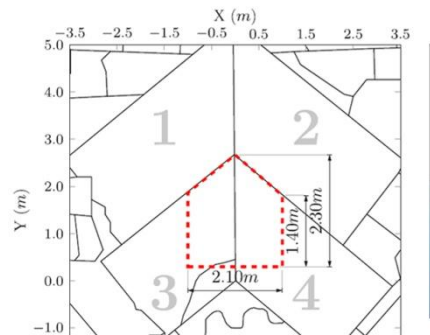

Figure 12: Estimated location and cross-sectional geometry of the hidden corridor.

4. Discussion and conclusion

.../...

GPR measurements allowed for a determination of the geometry of the anomaly, while the boundaries of the anomaly could be confirmed by UST measurements in all areas without obstructions or deteriorations of the surfaces.

.../...

. Moreover, the simulations helped to ascertain that the anomaly is an air-filled void. Image fusion was employed to merge GPR and UST profiles and further confirm the position of the strong reflectors caused by the backwall of the Chevron, as well as the extent of the large anomaly behind it. The anomaly appears to extend to and align with the block joint between the upper (Blocks 1 and 2) and lower (Blocks 3 and 4) blocks of the Chevron. The data suggest that due to the high relative width of the corridor (2.10 m), a flat ceiling design, as used for other corridors, was no longer feasible with limestone, which is also in line with the design of other structures in ancient Egypt

²²⁹ Ultrasonic testing

STRABO'S PORTCULLIS CHAMBER

The results do not indicate that this corridor has an orientation other than horizontal and normal to the Chevron face. The central height of the corridor is estimated to be 2.30 m. The estimated location and cross-sectional geometry of the hidden corridor are illustrated in Fig. 12. Note that the used NDT methods cannot contribute to a discussion about the extent of this void in the depth direction. However, measurements by cosmic ray muons helped estimate the corridor's extent in the depth direction to be at least 9 m [2].

Based on the findings of this study, the research team of the Scan-Pyramids project can determine and propose coordinates for a small diameter borehole, which will, for the first time, allow the visual inspection of the hidden corridor. A corresponding proposal for such a borehole will be submitted to the Supreme Council of Antiquities, Ministry of Tourism and Antiquities, Egypt”.



Data acquisition with ground-penetrating radar.



Data acquisition with ultrasound.

This authorization had been obtained, and the endoscopy performed at the end of February 2023 did not require drilling, as the endoscope could be introduced into the chamber through a gap between the limestone blocks.

Otherwise, just before the winter holiday season of 2022, I began to have my suspicions about the forthcoming announcement of an extraordinary discovery based on the most recent analyses of muographic data from Dr. Morishima's Nagoya team, Sébastien Procureur's CEA team and results in progress from the Munich Technical University team. I had received a message, in enigmatic form, telling me: *"Santa Claus has thought of you and put something in the pipeline"*.

Two months later, two days before the press conference on March 2, 2023, I was discreetly "congratulated" because the ScanPyramids mission had discovered "a void above the North face entrance²³⁰" without any further details. However, I had no images of this discovery, so I waited for the official presentation.

And on that day, I was not disappointed...

²³⁰ In English.

Press conference on March 2, 2023 in front of Khufu's Pyramid

Before arriving at this memorable day, and following the results accumulated over more than seven years and summarized in the two articles²³¹ which were to be simultaneously published online just after the press conference, ScanPyramids had received authorization to perform an endoscopy.

At the end of February, an endoscope was inserted, without drilling, and the first images of a chamber of beautiful proportions appeared on the operators' control screen. The discovery of a chamber of this size, unseen by a human being for over forty-five centuries, was the most important since Howard Vyse's 1837 discovery of the last so-called relieving chamber above the King's Chamber.



First video images recorded by the endoscope of the second entrance chamber of the Great Pyramid Noble Circuit. This discovery was made without drilling any few centimeters large hole that had been envisaged; the flexible tube in which the endoscope moved had been introduced into the chamber through a gap uncovered between the limestone blocks.

On the following March 2nd, under a marquee erected for the occasion in front of the entrance to the Cheops Pyramid, and in front of international and local media coverage, Mr. Ahmed Isa, Minister of Tourism and Archaeology, began the conference with a welcome speech, noting that (French translation from the press release²³²):

“...the pyramids of Giza attracted the world's attention to Egypt for thousands of years and are still under view until it became a distinctive and essential element of the mental image when talking about Egypt or tourism in it, noting that Giza pyramids are The most important and prominent monuments in the world, visiting them was and still remains the dream of hundreds of millions around the world.

.../...

... the results of the journey of this important scientific project have shown the presence of a Gabled corridor on the northern face of the Great Khufu Pyramid, 9 meters long and about 2.10 meters wide.

.../....

...the continuation of work and scientific research using technological and scientific methods and completely safe, to uncover more secrets of the ancient Egyptian civilization, one of the strengths of Egypt”.

²³¹ The Egyptian authorities had already been informed for some time.

²³² The text can be hard to follow at times...

STRABO'S PORTCULLIS CHAMBER

Then, Dr Zahi Hawass confirmed that:

"...today's discovery is of great importance, describing it as the most important scientific discovery in modern times and in the 21st century Egypt, inside the pyramid of King Khufu..

.../...

...the urgency to continue its support to uncover more secrets about this uncovered corridor and what it may lead to, which is likely to lead to King Khufu's burial chamber which has not yet been discovered, especially that the monuments of the King Khufu has not been found yet. (sic)".

Then Mustafa Waziri, Secretary General of the Supreme Council of Archaeology, explained that:

"This corridor has been reached by inserting a very small telescope with a camera at one of the openings at the entrance of the pyramid, which takes the aesthetic shape, probably the function of this corridor, is to relieve the pressure and weight of any structure below it up to about 7 meters, and that the blocks of beauty that form the corridor ceiling are distributed The weight above the corridor down and sideways away from it, the coming months will surely tell us what could be behind this corridor as another corridor may be unearthed beneath it (sic)".

Finally, Hany Helal, former Minister of Higher Education and Scientific Research and coordinator of the ScanPyramids project, reviewed the details of the project and its results, as well as the scientific steps taken to achieve today's discovery, pointing out that:

"...the modern technologies used to explore the stone Gabled area above the entrance of the corridor on the northern face of the Great Pyramid are completely safe and consist of five different technologies: infrared, muon particles, georadar, ultrasound, 3D digital architectural simulation and analysis.

.../...

"...the scientific results of the recent measurements of the project were accepted for publication in the renowned international scientific journals Nature and NTD&E last January, and will be published after the press conference is over".

That said, while Hany Helal insisted that it was now important to continue investigations to discover what lay BEHIND the stone slabs at the back of the room and ABOVE the rafters roof, Mustapha Waziri and Zahi Hawass were all over the TV channels interviewing them, hammering the point that there was "NOTHING TO SEE BEHIND THE WALL OR ABOVE THE ROOF"...and that the uncovered corridor was there to "PROTECT SOMETHING BELOW...MAYBE THE KING'S CHAMBER..."²³³ "



Screenshot of the first video of this chamber not seen for over 45 Centuries!



Screenshot of the "Khufu Reborn" 3D animation presented to the public on January 27, 2011.

²³³ I'll let readers make up their own minds about these remarks. It was not a surprise to me: "If you can't convince them, confuse them".

STRABO'S PORTCULLIS CHAMBER

8 - "GOOD LORD! BUT IT'S OF COURSE!"

This sentence could have been uttered by Blake or Mortimer²³⁴ in Volume 2 of Edgar. P. Jacobs, "The Mystery of the Great Pyramid", in which the heroes are in search of the Chamber of Horus.



In a pizzeria with François Schuiten on November 25, 2016 after a working meeting with the ScanPyramids team; the topic of the day was... the discovery of the anomaly behind the chevrons by the Nagoya team. For once, I'm drawing on a paper napkin to explain to François what I imagine about this discovery.

This is not the case...

This phrase marked an era of French television that people of my generation couldn't miss; in the late 50's and especially in the 60's, it was uttered by the famous police commissioner Antoine Bourrel²³⁵ at the end of an investigation in every episode, in black and white, of the series "Les Cinq Dernières Minutes²³⁶". The commissioner would finally solve a crime in the last five minutes and, tapping the palm of his left hand with the fist of his right, he would utter the cult phrase: "Good Lord! But it's of course!"

That's what happened to me...

In the first paragraph of Chapter 6 I wrote:

Architecture is "The Art of designing and constructing buildings", and one of the main missions of this Art is to reconcile their "FUNCTION" and their "FORM" in an aesthetic creation, which can translate in a multitude of solutions...

And in the previous chapter, page 66:

"As of September 2016, the three major contributions were as follows:
- The storage of Strabo's Portcullis in a vertical well for total protection ,
- The idea of lateral counterweights to slow the lowering of Strabo's Portcullis,
- The push of Strabo's Portcullis only runs about twenty centimeters".

On March 27, 2023, Mehdi Tayoubi sent me a message accompanied by a photo captured on the short video that had been filmed during the discovery of the chamber. He had surrounded a detail that appeared on the wall closing off the chamber at the back and was asking for my opinion.

²³⁴ A nod to François Schuiten, Vice-President and co-founder of HIP.Institute. Schuiten is the author, with Van Dormael, Gunzig and Durieux, of a Blake & Mortimer adventure, "Le Dernier Pharaon", a tribute to Edgar P. Jacobs published by Blake & Mortimer.

²³⁵ Played by actor Raymond Souplex.

²³⁶ Directed at the time by Claude Loursais.

STRABO'S PORTCULLIS CHAMBER

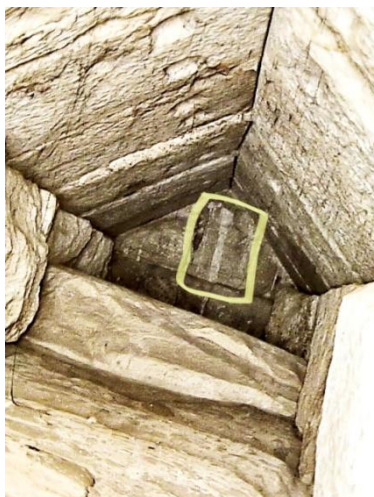

The screenshot of the back wall with, surrounded, the apparent trace of a white drip (plaster water?) on a vertical slab set on a low stone wall made of well-cut blocks and surfaced on top.

Apart from the cavities dug under the rafters, which played a role during installation, other details stand out: the vertical block on the right, which is very flat, and the beam separating the two levels of the chamber floor.

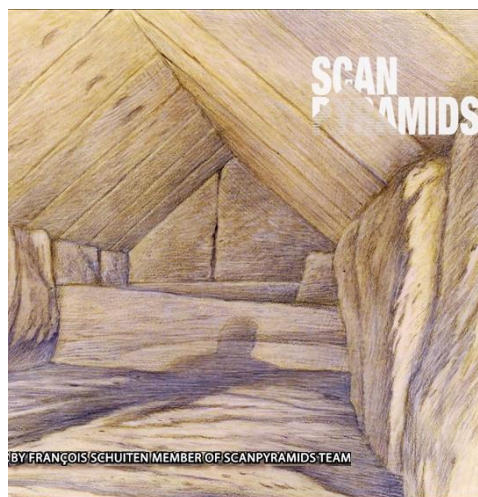

In this drawing by François Schuiten, the author²³⁷ highlights several details he noticed in the documents he viewed:

- the vertical joint between the two rear slabs,
- the low wall supporting them,
- the vertical blocks below the rafters on the left and those on the right in the foreground,
- the beam separating the two floor levels.



- In this screenshot of the video shown when the discovery was announced, we can see other details:
- the floor is made up of large slabs (blocks) on either side of the longitudinal axis, which have not been leveled,
 - and, ABOVE ALL, the faces of the blocks on the left under the rafters remain unfinished,

It's clear that the architects had no reason to flatten the central passageway, and that they created a level offset in the rear part of the chamber, certainly with a view to bringing this level as close as possible to that of another structure just behind the two rear slabs.

In this respect, if the chamber had been closed during construction, the architects would have installed masonry of the same type as that on the gables of the last chamber of the structure above the King's Chamber.

The reason they chose to close it with two full-height slabs was that the closing operation had to be very quick.

Finally, after the official announcement²³⁸ of the discovery of the chamber behind the entrance rafters, I attended a meeting in Paris on April 5 with Hany Helal, Mehdi Tayoubi and several members²³⁹ of the mission to discuss the need for further investigation by CT scan and endoscopy in order to obtain more data, shape and images, of the chamber. The discussion focused on the most appropriate type of endoscope and "tube" for a better investigation.

²³⁷ Well-informed, as Vice-President of HIP.Institute, he points out the joint separating the two vertical slabs visible in the video screenshots.

²³⁸ March 2, 2023, in front of the Khufu Pyramid in Giza.

²³⁹ Nicolas Sérkoff, Jean-Baptiste Mouret on site and Benoît Marini by videoconference.

STRABO'S PORTCULLIS CHAMBER

During this meeting, a sentence from Benoît Marini²⁴⁰ immediately alerted me; he said (from memory): *"Curiously, at the front of the room, the edges of the two large blocks on the floor are cut on a rounded slant into which, in the center, a good-sized notch has been cut; inside, there's a small square flat block cleanly cut, which looks as if it has been abandoned"*.

When I got home, I went back into the many files stored on my computer relating to this entrance chamber, revisiting the stages of its evolution since the first sketches in the summer of 2003.

And all of a sudden, I clicked like Commissioner Bourrel: *"Good Lord! But it's of course!"*

I realized that since the beginning of my Noble Circuit theory, I'd been imagining that the sarcophagus of Khufu's mummy was transported in a **LONGITUDINAL** direction from the North face entrance to the second ascending corridor. Once introduced into the first chamber above the descending corridor, the sarcophagus was transferred, passing under the lower pair of rafters, into the second chamber, whose floor had to be at the same level as the²⁴¹ base of the Strabo Stone. Because of its weight²⁴², I stored the latter at the rear of this second chamber, while the transfer of the sarcophagus to the Circuit Noble was carried out at the top of the back wall of this chamber; an opening allowed entry into the second horizontal corridor leading directly to the Queen's Chamber. The second, ascending corridor also started²⁴³ from this same opening.

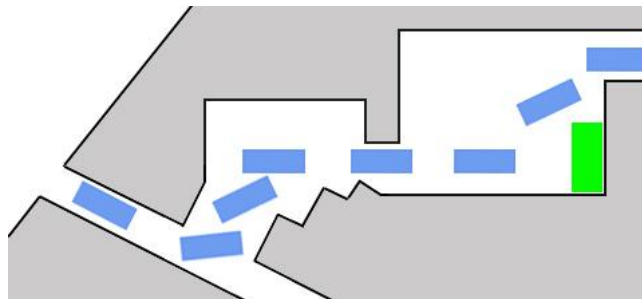

Schematic diagram showing the passage of Khufu's sarcophagus during the funeral, which has been the basis of my Noble Circuit theory since 2003. The sarcophagus was transported LONGITUALLY from the North face entrance to the opening leading to the corridors of the Noble Circuit, so that it could pass from the 1st chamber to the second.

The length of the latter was dictated by the need to accommodate the internal ramp just above it. In my theory, this length was also linked to the microgravimetry image in relation to the internal ramp.

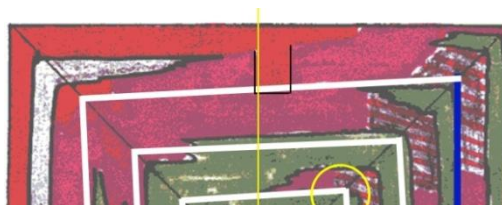

The overdensity (in bright red) observed by microgravimetry in 1986/87 penetrated deep into the pyramid behind the entrance rafters, its position being in line with these as shown by the North-South axis (in yellow).

Note: the yellow circle at the bottom right of the image corresponds to the position of the existing Cavity C2, which I've been calling "Bob's room" since Egyptologist Bob Brier was able to enter it during the filming of the documentary "Khufu Revealed" in 2008. It is exactly on the route of the internal ramp. I'll return to this subject in my third Memoir, dedicated to Cavity C1, discovered by the CEA some twenty meters above Cavity C2.

This Cavity C1 is also on the route of the internal ramp at its next turn under the North-East edge.

²⁴⁰ Benoît Marini was working on the virtual reconstruction of the data and images obtained during the discovery of the chamber.

²⁴¹ See the two drawings by Gilles Dormion on page 52.

²⁴² Due to its greater thickness, it can be moved vertically.

²⁴³ A repetition of the junction principle between the existing horizontal corridor and the Grand Gallery.

STRABO'S PORTCULLIS CHAMBER

The architects' stroke of genius was to come up with the idea of turning the sarcophagus 90° to make it pass **TRANSVERSALLY** from the first chamber to the second. This solution limited the width of the passage needed to the minimum, about one cubit, sufficient for transferring the sarcophagus. On the other hand, its rotation required chambers of at least four cubits, 2.10 m of free width, i.e. slightly more than the length of the sarcophagus²⁴⁴.



Top view, without cover.



Longitudinal view (left) and transverse view (right).

Modeling²⁴⁵ of the sarcophagus of Khufu based on the dimensions²⁴⁶ of the granite sarcophagus in the King's Chamber.

From this minimum width, the designers had no choice but to cover these two chambers with rafters, as a corbelled roof, with a much greater height, would not have been appropriate so close to the North face. What's more, it would have blocked the passageway for the nearby internal ramp. In the end, they opted for a width of 7 cubits²⁴⁷ (3.67 m) for both chambers, for a further reason discussed below.

In designing these two entrance chambers, the architects succeeded in giving the Strabo Stone a shape that would be optimal for the two functions of its mission, but which imposed the "form" of these two chambers, particularly at the level of the sarcophagus's passage from one to the other.

They knew that in its first "function", laying the roof rafters²⁴⁸ of the first entrance chamber, the Stone didn't need to be very thick, as it was going to be leaning²⁴⁹ against the masonry of a vertical well in which it would not be stored, as in my sketch on page 64. In its second "function", that of PORTCULLIS, this well would serve as a passage for the Stone stored in the second chamber, and also become its final dwelling. A thickness of one cubit was sufficient for the Stone, the vertical well having a width of the same order²⁵⁰.

For the lowering of the Stone, weighing around seven tons, the descent was to be braked by a counterweight system²⁵¹, but contrary to the same sketch on page 64, this was positioned on the floor of the second chamber at the level of the upper part of the well. The counterweight, weighing around fifteen tons, i.e. about twice the weight of the Stone, was to be divided into two series of limestone blocks distributed on either side of the central passage. The friction of the Stone against the East,

²⁴⁴ The dimensions of the wooden sarcophagus, 1.96 m x 0.52 m x 0.50 m, were determined by the interior dimensions of the granite sarcophagus in the King's Chamber,

²⁴⁵ By Pierre Gable and the Emissive team.

²⁴⁶ That's 1.98 m long and 0.67 m wide; 1 palm (7.5 cm) was deducted on each side for the ropes used to place the wooden sarcophagus, leaving a width of one cubit (52.4cm).

By way of comparison, a late 11th Dynasty wooden sarcophagus discovered in 1903 in tomb 7 at Nakhti (Middle Egypt) measures 1.97 m long, 0.50 m wide and 0.53 m high.

²⁴⁷ This didn't make much difference to the thickness of the roof.

²⁴⁸ The next chapter covers the installation of the rafters for the two entrance chambers.

²⁴⁹ About twenty centimeters ahead, but blocked by wedges to compensate for the small gap necessary for a maneuver I'll talk about in the next chapter.

²⁵⁰ The wall at the back of the latter is slightly sloped to optimize maneuvering.

²⁵¹ The same principle applies as described in the next chapter regarding the installation of the rafters.

STRABO'S PORTCULLIS CHAMBER

South and West walls of the²⁵² well, and the weight of the heavy blocks rubbing against the ground, would provide most of the braking²⁵³, with the balance²⁵⁴ being provided by a team of four workers holding two complementary rope lines.

Note: The principle sketches below, developed from those²⁵⁵ presented on pages 64 to 66, have been rotated by 180° to be in the same direction as the vast majority of the sketches that will follow in this Memoir.

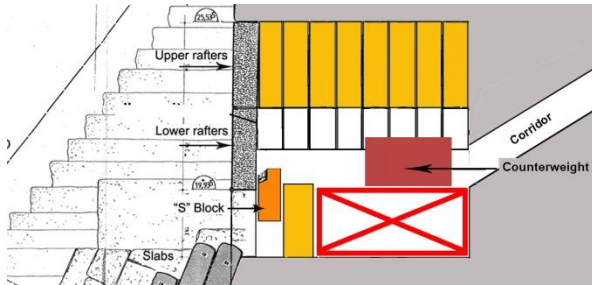

Moving down the dividing wall in the first sketch on the left of page 64, the passage from the first to the second chamber is shown at the top.

The Stone can be transferred to the second chamber. The²⁵⁶ hoisting of the stone, having been carried out before the construction of the rafter roof, poses no problem. The counterweight blocks are stored towards the rear of the chamber, on either side of the central passage.

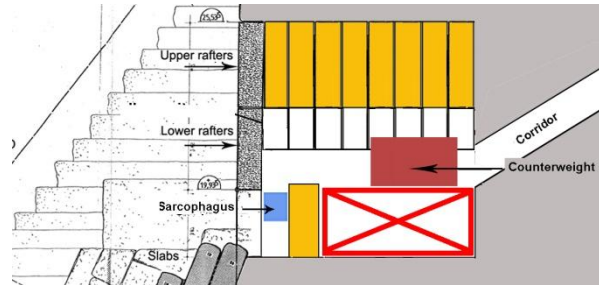

Since the Strabo Stone and the Khufu sarcophagus are of the same width, the latter can also be transferred, provided that it is moved transversely rather than longitudinally during this maneuver.

Hoisting the sarcophagus requires less force²⁵⁷, the weight of Khufu's mummy being only around 35% of its original weight²⁵⁸.

Direct consequence:

The whole area of the second chamber in my Noble Circuit theory illustrated by a red "crossed-out rectangle" is no longer of any use and can be removed; the floor of this chamber can be raised to the top level of the rectangle.

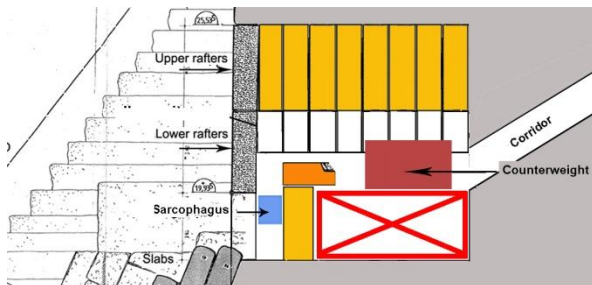

When transferring the sarcophagus, the Stone is stored at the edge of the vertical well, leaving enough space for it to pass to the rear of the second chamber.

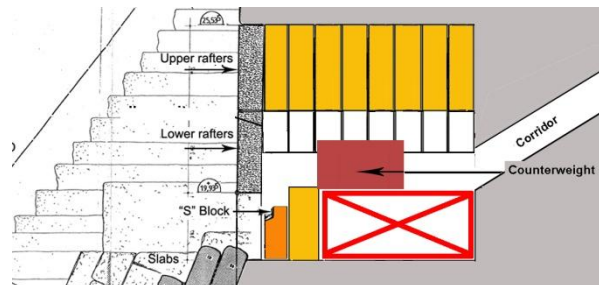

After the funeral, when the pyramid is sealed, the Stone, now fulfilling its second function, is lowered into its final slot with the help of the counterweight and a small team of workers; the counterweight has moved forward by the distance the Stone has travelled.

The Stone is then pushed forward some twenty centimeters to be set under the rafters.

Consequence on the architecture of the two entrance chambers compared to that imagined in the Noble Circuit:

The first chamber remains unchanged, while the second is much lower under the ceiling; its length now depends on the counterweight stroke and other components needed to seal the whole perfectly.

²⁵² This wall had a slope of 80° for the occasion.

²⁵³ A force of around 670 kg per ton was needed to stop the Stone's descent, so a total force of 4.7 tons was required.

²⁵⁴ Since a force of 300 kg is required to pull 1 ton across a flat, rough surface, 15.7 tons of blocks were needed to stop the Stone. By dividing 8 blocks of 2 tons each on either side of the second chamber, there would have been enough counterforce to block the Stone. That said, to control the maneuver, the counterweight was limited to 15 tons, with the additional braking provided by a team of four workers using the 2-strand technique - (See Memoir The BIG VOID starting on page 116 History of the counterweight system).

²⁵⁵ The horizontal corridor of the Noble Circuit is still not represented.

²⁵⁶ This maneuver is described in the next chapter.

²⁵⁷ 4 operators, 2 at the bottom and 2 at the top, are sufficient for this maneuver.

²⁵⁸ The human body is made up of 65% water, which is removed during the mummification process.

STRABO'S PORTCULLIS CHAMBER

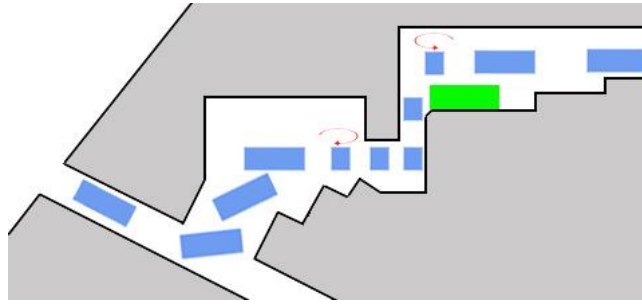

Schematic diagram showing the passage of Khufu's sarcophagus during burial, following the discovery of the second entrance chamber by the ScanPyramids mission in 2023, twenty years after the idea of the Noble Circuit. The first chamber has remained unchanged, and the shape of the second has seen only two major modifications: The sarcophagus is transferred via a vertical well, and the floor has been raised by more than 2 m.

In my Mémoire sur Le BIG VOID, I wrote in the subtitle of Chapter 3²⁵⁹ :

"A problem without a solution is a problem badly posed" - Albert Einstein

In January 1999, my father "broke" the basic paradigm that the pyramid had been built from the outside by inverting the problem with just these words: "built from the inside". For the past twenty-five years, thanks to this breadcrumb trail, I've been able to develop a complete theory that provides a logical and coherent response to all the problems encountered on this so-called "Pharaonic" building site, but which is only the result of the designers' intelligence, which is transcribed in the smallest details because they always asked themselves the right questions before answering them.

Thanks to the discovery of the second entrance chamber, and in order to arrive at this conclusion concerning its "form" and "function", it was sufficient, once again, to change the basic paradigm on which I had been relying since 2003; with the problem now correctly posed, the solution became simple and obvious:

"The transfer of the sarcophagus from the first to the second chamber was not LONGITUDINAL, but TRANSVERSAL!"

At the same time, Strabo's Stone became a portcullis whose function was optimal, and the second chamber would also be optimally shaped for its function as the PORTCULLIS CHAMBER.

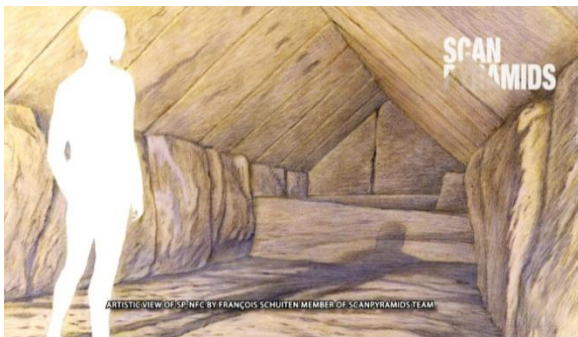

On the left, François Schuiten's artistic view of the SP-NFC; on the right a screenshot of the model of the second entrance chamber as depicted in the 3D animation "Khufu Reborn" presented to the public on January 27, 2011 at the Géode in Paris²⁶⁰. The only notable difference between the two images²⁶¹ is that, in the image on the right, the volume up to the top level of the Stone (where the upper workers stand), in which (in blur) three people can be seen standing, is no longer of any use, the sarcophagus having been transferred transversely from the first to the second chamber.

²⁵⁹ Page 7, 3 - THE PROBLEM OF BUILDING THE KING'S CHAMBER.

²⁶⁰ As part of my collaboration with Dassault Systèmes which began in 2005.

²⁶¹ Editing on a suggestion of Laurent Bellaïche-Wagner. The picture on the right is the same as the one on the right at the bottom of page 78.

STRABO'S PORTCULLIS CHAMBER

9 - LAYING THE RAFTERS FOR THE TWO ENTRANCE CHAMBERS

Information note N°4 :

When I first proposed the use of a counterweight in the Grand Gallery²⁶², I was confronted with the problem of setting the rafters for the roofs of the Queen's Chamber²⁶³ and the King's Chamber. In the first version of December 2002, these rafters were installed directly on arrival at their destination, without any further temporary storage. Lifting them was out of the question due to their weight, and I imagined that they would be installed as they arrived, with a wooden template built inside the Queen's Chamber and in the last chamber of the superstructure above the King's Chamber for maneuvering purposes. The rafters of the North-facing slope, built first, were delivered in line with the Grand Gallery, then slid and tilted onto a sloping support wall the length of the roof. They were then pushed into their final position, starting from the West and finishing in the East. The rafters of the Southern slope, built second, were pivoted vertically before being folded down and slid against the rafters of the Northern slope already in place to form a vault. In my mind, the idea of a layout based solely on this kind of maneuvering was well within the Egyptians' grasp, but I was aware of two problematic steps that appeared: the lateral pushing of the rafters into their final position and the vertical pivoting of the South rafters.

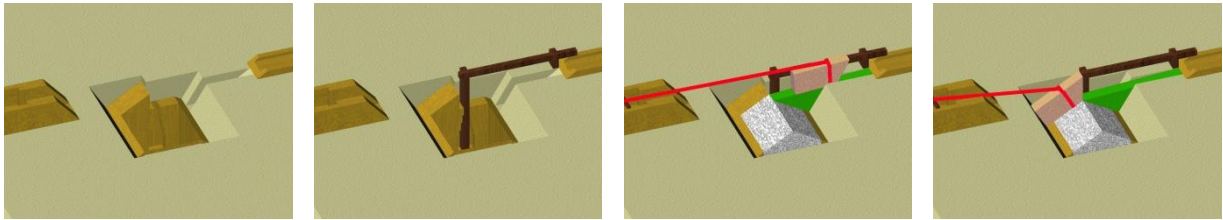

The installation sequences for the rafters of the Queen's Chamber roof were based on the installation of a

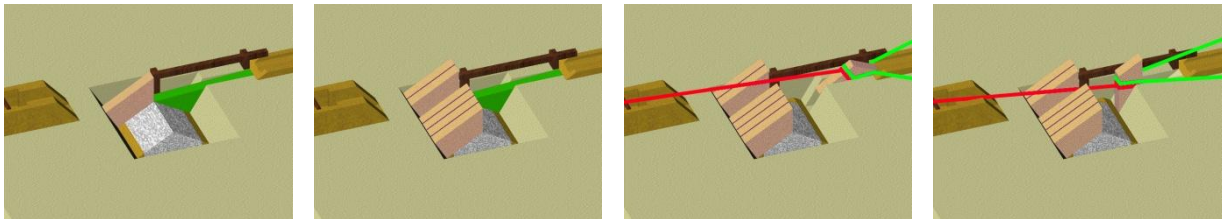

wooden template in it. The North side was built first, the South side last.

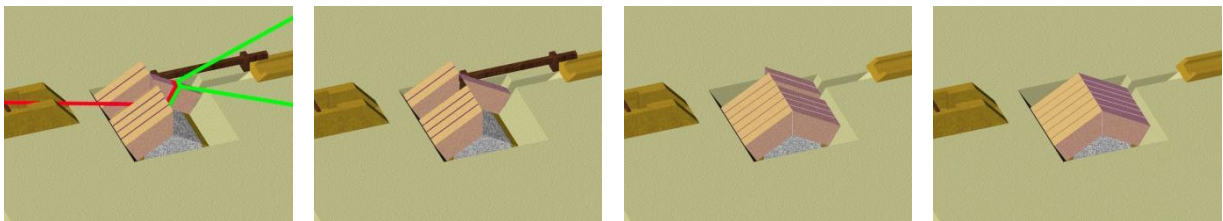

The lateral thrust of the rafters and the pivoting of the rafters on the South-facing slope were problematic. That said, the basic idea was simple and logical, and could be relatively easily improved on these two shortcomings.

²⁶² See BIG VOID Memory, Chapter 4, from page 9 to page 19.

²⁶³ In my very first version of the counterweight system, a small counterweight would have been used to position the rafters of the Queen's Chamber roof. It would have circulated in the ascending corridor. This idea was quickly abandoned.

STRABO'S PORTCULLIS CHAMBER

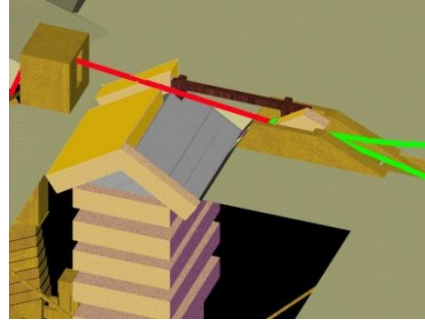
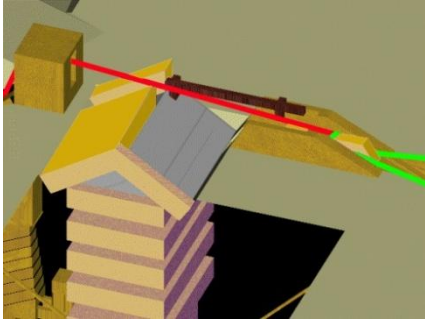

Sequence of the pivoting of a rafter on the South-facing slope of the King's Chamber roof.

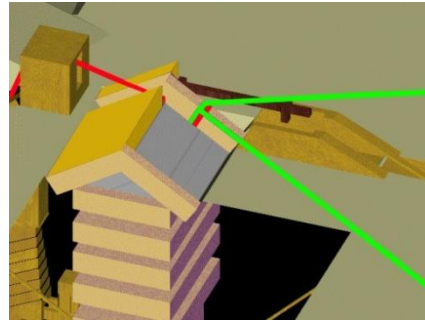
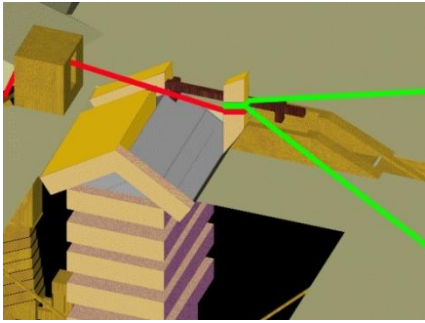

After removal from the wooden jig built into the roof's rear chamber, lateral thrust was problematic.

The solution to the problem of rafters being pushed sideways onto their inclined support wall was found in early 2005, when the theory was updated. The rafters were now hoisted up to the level where they were to be installed, and stored in a holding area in line with their future location: those on the North-facing slope in the first row, those on the South-facing slope in the second row. The solution to the problem of the South slope rafters pivoting was resolved on August 2, 2016, during the ScanPyramids mission, following the infrared results and the first unofficial announcement by the Nagoya team of the discovery of a corridor-shaped anomaly behind the entrance rafters. Prior to this, in the preceding months I had studied the²⁶⁴ area extensively and learned a great deal about the arrangement of the blocks around the gaping hole in front of the rafters.

I quickly drew up a series of sketches²⁶⁵ on the sequences for installing the entrance rafters, which solved the second problem - that of pivoting the rafters of the second slope to be built into a roof composed of a rafter vault.

The complete update on the construction of this type of vault is the subject of the very long chapter that follows, with the construction of the roofs of the two entrance chambers.

²⁶⁴ With Pierre Gable creating the 3D models for the scientific teams on site.

²⁶⁵ A slideshow summarizing the entire procedure was submitted on this occasion to set the date.

STRABO'S PORTCULLIS CHAMBER

The Strabo Stone²⁶⁶ and its two functions



Dominique Vivant Denon.
Voyage dans la Haute et la Basse Egypte 1802.
In this precise drawing, the artist has noted certain details of the blocks setting that are highly informative.

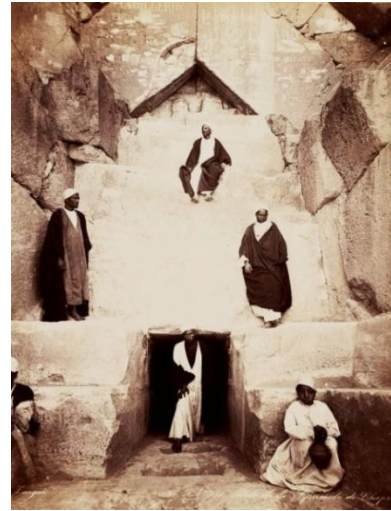

Zangaki Brothers late 19th century.
In this photo, the same details are also visible.



Recent photo close-up of the double pair of chevrons.



Photo of the Strabo Stone inserted beneath the lower pair of rafters.
On the left, the foot of a broken rafter is visible.

In the roofs of the Queen's Chamber and the King's Chamber, the rafters of the two slopes don't match face to face, but are staggered for a simple reason: when building the first slope, there are no precise positioning constraints, as the lateral limits are free. Once the first slope is complete, the rafters of the second also have no particular constraints other than covering the remaining part of the roof; this resulted in a staggered installation. That said, in the case of the two entrance chambers, the roofs are built with a basic constraint in mind: the "boundary" between the roof of the first and that of the second is decisive, as it is linked to the two functions that the architects gave to Strabo's Stone. This kind of duality is also to be found on the pyramid's construction site, as the designers sometimes gave two functions to certain components²⁶⁷ of the project, this block of Turah limestone in particular, as we saw in the previous chapter: firstly, for the construction of the first entrance chamber of the Noble Circuit, and secondly, for the final sealing of the latter after the funeral of King Khufu.

²⁶⁶ I also use the word Stone alone, with a capital S, instead of Strabo's Stone.

²⁶⁷ To cite just a few examples of dual functions: the King's Chamber shafts (intercom and ventilation), the Portcullis Chamber (motor well for the counterweight system in the second Grand Gallery and entrance barrier to the King's Chamber) or the Queen's Chamber and King's Chamber (intercom relay and burial chamber). See Memoir The BIG VOID.

STRABO'S PORTCULLIS CHAMBER

What's remarkable about it is that the designers succeeded in optimizing each of the two functions, which wasn't always the case²⁶⁸. This success is linked to the programming of construction in successive roof sequences, which imposed a basic rule: the rafters had to be laid face to face to allow easy transition from one sequence to the next, and the direction in which they were laid differed from one roof to the next. Finally, the point of origin for the first sequence was the installation of the lower rafter pair directly above the Strabo Stone, as it was at the heart of the function with the second roof rafter pair immediately to the rear of the upper rafter pair above it.



The rafters in the green zone are at the heart of the first function of Strabo's Stone and conditioned the construction sequences. The rafters on the roof of the first chamber were laid in a South-North direction, starting with the Southernmost pair of rafters still visible on the North face.

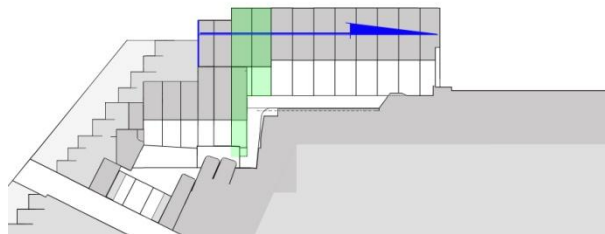

The rafters for the roof of the second chamber were laid in a North-South direction, starting with the Northernmost pair of rafters and overlapping part of the roof of the first chamber.

The following text describes the first function, the second being covered in a later chapter.

The first function: a key element in the construction of the first entrance chamber.

The "notches" on the upper part of the Strabo Stone are linked to this function, and were made to implement a technique linked to the construction of the first chamber's chevrons roof.

The problem lay in the fact that this chamber was very close to the façade, and was intended to cover a large void straddling the descending corridor to which it was connected by a well. As a result, the working space was limited and not suited to the installation of a traditional wooden template. The solution which came up with was based on a mixed stone and wood structure, with the stone part remaining an integral part of the monument after its function had been fulfilled, and only the wood part being dismantled and recovered.

²⁶⁸ The Portcullis Chamber between the Grand Gallery and the King's Chamber was optimized for its function in connection with the counterweight system of the second Grand Gallery, but to the detriment of its function as a defensive barrier against break-in by looters. The designers had no idea that looters could reach it from the North entrance, which was already 13 cubits out of line with the North-South axis, making it difficult to spot (hence Strabo's famous text: *on one of its faces...*).

STRABO'S PORTCULLIS CHAMBER



View of the "notches" at the top of the Strabo Stone. They are the raison d'être of one of the stone's two functions. Limestone blocks were added to fill a small gap under the rafters.

As the roof was built from the West side of the future chamber, the notches were not made randomly, but were based on physics laws linked to the setting of the rafters on the East-facing slope, which was built first. As the rafters were brought to face their final position, the sequence of their installation began with the rafter furthest South²⁶⁹ and ended with the one closest to the North face. The Stone's function also remained active while the rafters on the Western slope of the roof were being laid, temporarily reinforcing the structure's stability.

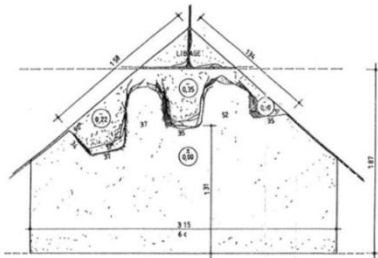

Gilles Dormion plan

Plan view of the visible part of the Strabo Stone. The three notches are not regular and are aligned on a slight slope from West to East. At the axis, two limestone blocks obstruct the space between the top of the stone and the underside of the rafters.

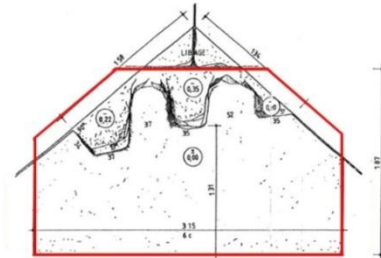

Gilles Dormion plan

The red line indicates the actual size of the Stone, whose upper, angled sides are not inserted under the rafters. The Stone is inserted under the rafters to prevent any attempt to lift it.

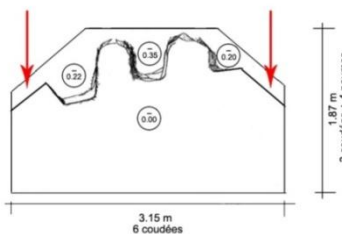

Gilles Dormion plan

The two red arrows indicate the lateral parts embedded beneath the rafters. The Stone is 6 cubits²⁷⁰ wide (3.15 m), 3 cubits 4 palms high (1.87 m) and 1 cubit thick. The notches are 20 to 35 cm deep.

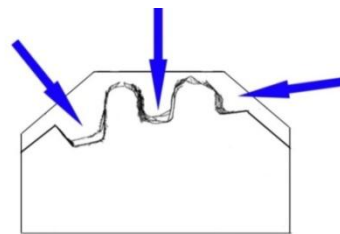

Designed by Gilles Dormion

The three blue arrows indicate the axes of the forces applied to the stone when the rafters on the East side of the first entrance chamber were installed.

- the one on the right indicates the one against the right notch.
- the central one indicates the vertical one.
- the one on the left indicates the oblique force exerted by the rafter as it rotates towards its final stop.

²⁶⁹ The one on the left above the Strabo Stone.

²⁷⁰ There's nothing to prevent the width from being greater than 6 cubits, but it must be just under 7 cubits.

STRABO'S PORTCULLIS CHAMBER

Construction of the East side of the first entrance chamber Longitudinal sections of the site²⁷¹.



- in the lower, sloping part, the descending corridor,
- in the center, the oblique connecting well, flanked on the right by the large oblique slabs,
- at the top, the future chamber under the rafters. In dark grey, the masonry lining the future chamber.

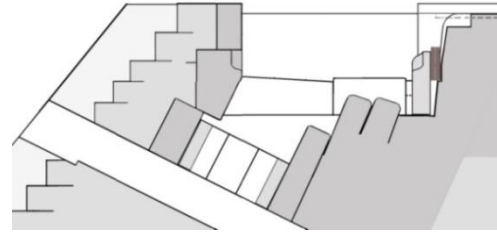

- on the right, the Strabo Stone with its notches is in position for the construction of the chevrons roof; it is at the back of the chamber, slightly advanced (in the same position as today), with pieces of wood (in dark brown) inserted between the Stone and the back wall to hold it in place.
- on the opposite side, a block of Turah limestone "mirrors" the stone, with the same notches.



- a long piece of wood (in medium grey) is inserted into the East notch of the Stone and its mirror (that of the oblique force). An intermediate triangular frame (not shown), resting on the chamber's East and West benches, acts as reinforcement under the piece of wood.

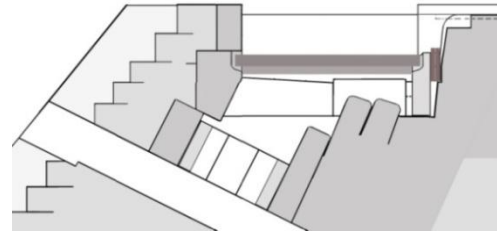

- a second piece of wood (in dark grey) is inserted into the central notch of the Stone and its mirror (the vertical force notch). The same triangular frame (not shown) is also used to reinforce this second piece of wood.

²⁷¹ The sketches shown are schematic diagrams illustrating the construction method. They also take into account existing details that are not shown. In some cases, an additional detail may be shown.

STRABO'S PORTCULLIS CHAMBER

Cross-sections of the site.

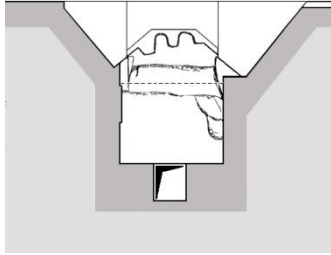

- Strabo's Stone is at the far end of the future chamber,
- In front, the sloping slabs, with the first one resting on the side walls of the descending corridor, determine the width of the chamber.
- at the top, the East and West stops designed to support the rafters on both sides.

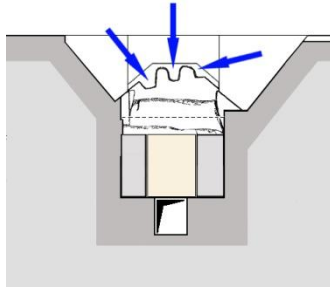

- in blue, the force diagrams shown above are plotted on the Stone for context.
- two lateral benches to the East and West flank the descending corridor, leaving 3 cubits of passage for the well.
- in the center, waiting against the large sloping slab, a stored slab for the future covering of the corridor.

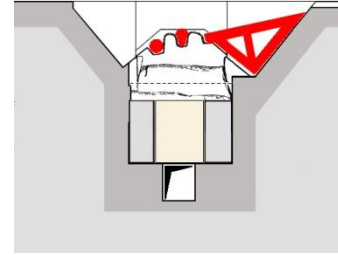

- the red circles represent the two pieces of wood inserted between the Stone and its mirror on the opposite side (the one on the left for the medium-gray piece and the one in the center for the dark-gray piece on the previous cut).
- a full-length timber-framed slide (in red) is blocked in the West notch of the Stone and its mirror.

Longitudinal sections of the site.

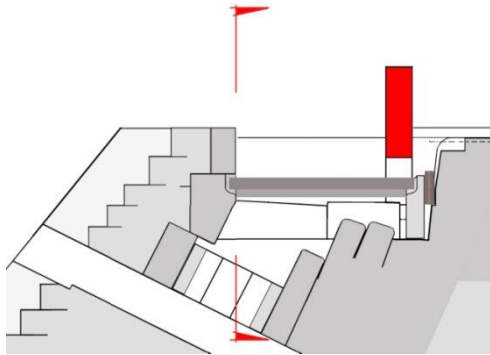

Setting the East rafter at the rear of the chamber. Once in place, this first rafter is blocked against the rear wall. (Red arrows indicate cross-sectional view)

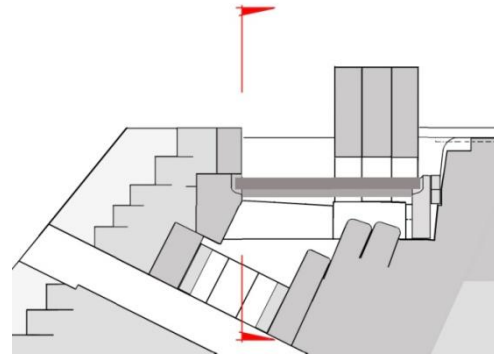

The installation of 2 other rafters at the front is identical. Each rafter is held tightly against the previous one.

Cross-sections of the site.

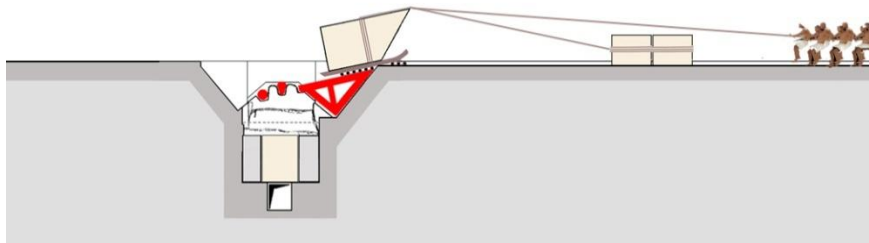

The rafter arrives on its transport sled. For the installation maneuvers, the rafter is connected by ropes to a series of blocks acting as counterweights to slow its descent by dragging²⁷² over prepared ground. This considerably reduces the number of men needed to ensure a slow, controlled glide to the stop.

²⁷² A technique used for navigation on the Nile when transporting granite blocks from Aswan. To keep the boat in line with the current, a block attached at the stern was dragged along the riverbed.

STRABO'S PORTCULLIS CHAMBER

Cross-sections of the site.

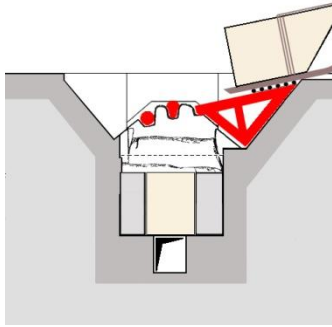

- the rafter transport sled arrives on rollers on the slide, braked by the counterweight and the pullers.

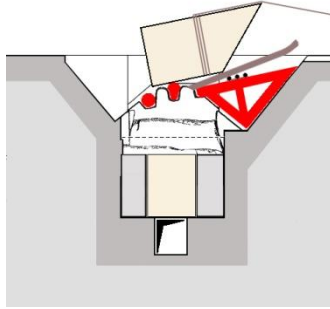

- the rafter is released from the sled and slowly glides to the vertical of the central piece of wood.

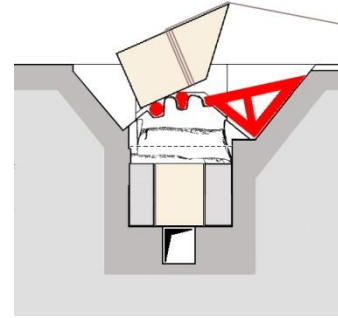

- with the sled removed, the rafter continues its descent, also resting on the second piece of wood.

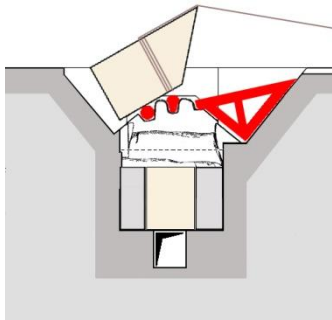

- the rafter rotates on the second piece of wood, its descent braked by the counterweight and the pullers.

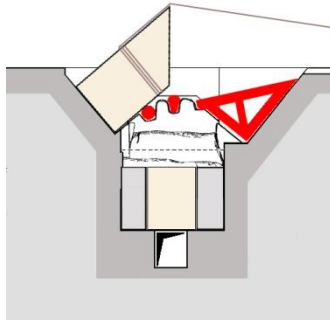

- the rafter now rests on the oblique stop and is supported by the second piece of wood.
- the South face of its lower section is flush with the masonry beneath the second chamber.

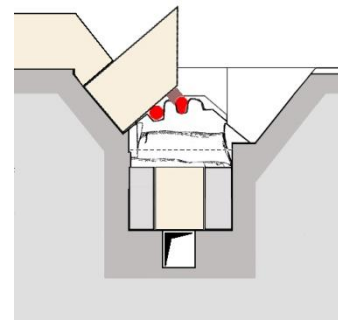

- two rows of layers are built to weigh on the bottom of the rafter and hold it in position.
- a wooden wedge is inserted between the rafter and the central piece of wood to reinforce the rafter blocking.

Longitudinal sections of the site.

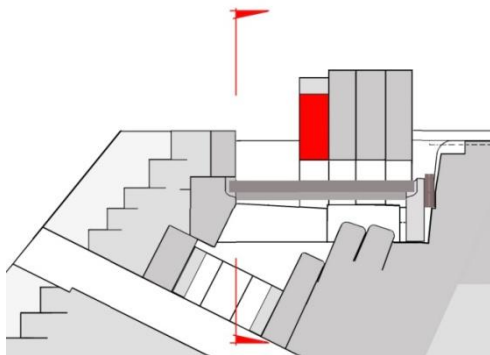

Setting of the 4th East rafter in the middle of the chamber:
- the 3 rafters in this section are lower and their base is inclined to rest on a sloping support length.
- they lean against the first 3 to block them.

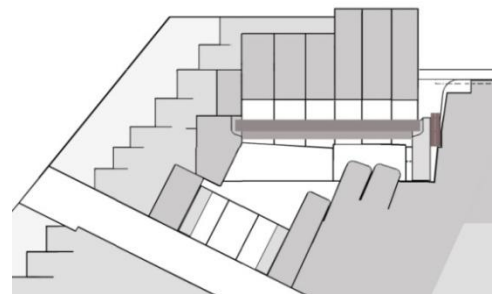

The installation of 2 other rafters at the front is identical. Once the last rafter of the Eastern slope is in place, it is blocked by the masonry of the adjoining courses.

STRABO'S PORTCULLIS CHAMBER

Cross-sections of the site.

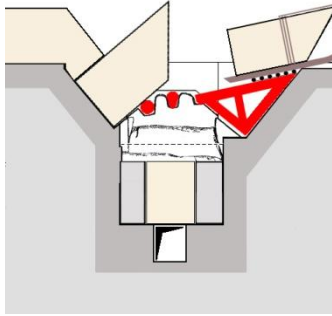

- the rafter transport sled arrives on rollers on the slide, braked by the counterweight and the pullers.

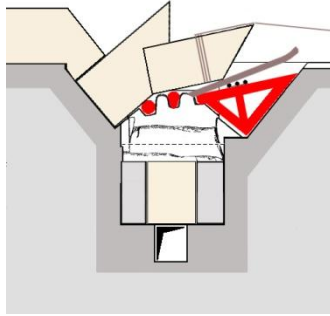

- the rafter is released from the sled and slowly glides to the vertical of the central piece of wood.

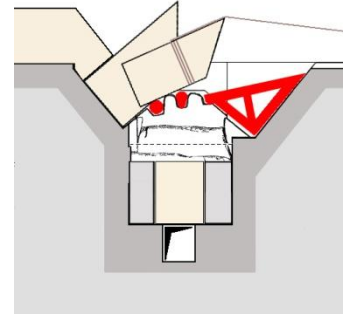

- With the sled removed, the rafter continues its descent, also resting on the second piece of wood.

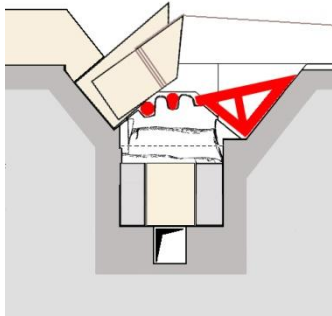

- the rafter rotates on the second piece of wood, its descent braked by the counterweight and the pullers.

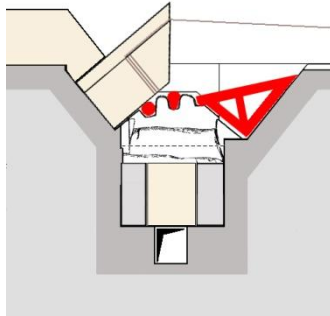

- the rafter now rests on the oblique stop and is supported by the second piece of wood.

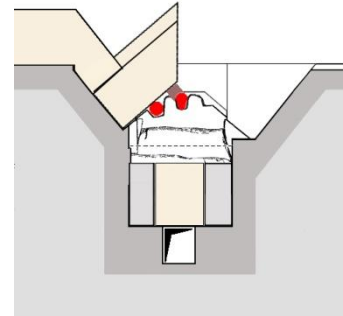

- two rows of layers are built to weigh on the bottom of the rafter and hold it in position.
- a wooden wedge is inserted between the rafter and the central piece of wood to reinforce the rafter blocking.

The Eastern slope of the chevrons roof of the first entrance chamber is complete.

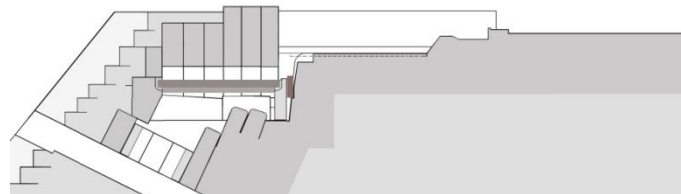

Aspect of the first entrance chamber after installation of the Eastern slope.

STRABO'S PORTCULLIS CHAMBER

Construction of the West side of the first entrance chamber Longitudinal sections of the site.

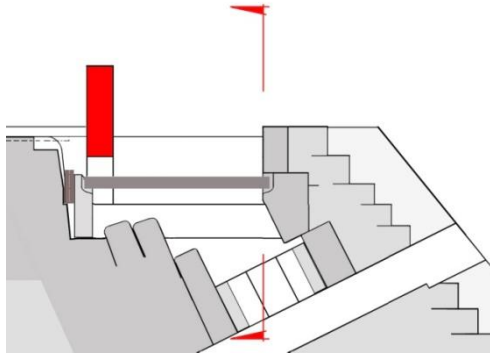

Setting of the West rafter at the back of the chamber.
(Red arrows indicate cross-sectional view)

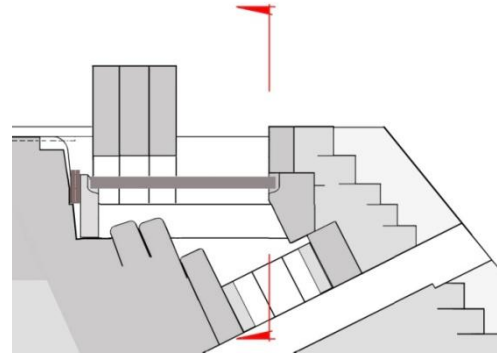

The installation of 2 other rafters at the front is identical.

Cross-sections of the site.

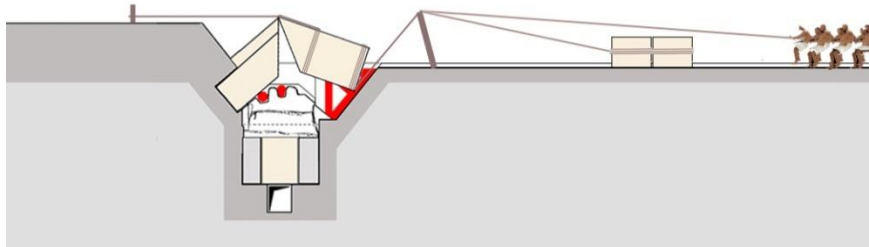

At the start of the installation maneuvers, the rafter is connected by ropes to a series of blocks acting as counterweights to slow down its rotation by dragging it over prepared ground. The front of the rafter is held under pressure against the head of the rafter on the Eastern slope, which serves as the axis of rotation. This considerably reduces the number of men needed to ensure slow, controlled rotation to the stop.

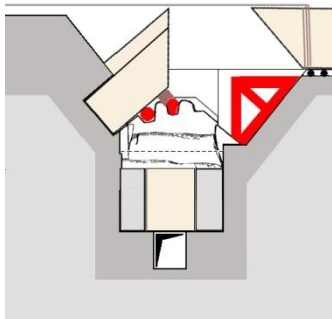

- the rafter was unloaded from the sled and pulled over rollers onto a wooden rotation platform.

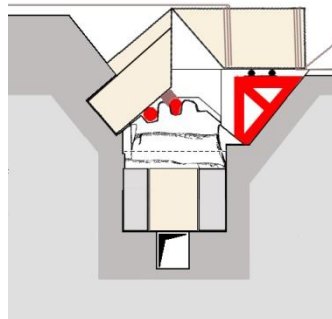

- the tip of the rafter is pressed against that of the rafter already in place.
- ropes tied to a post anchored in the pyramid's mass hold the rafter in place.

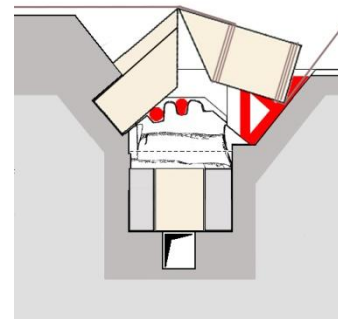

- the rotation of the chevron begins²⁷³, braked from behind by the counterweight and the pulling team.

²⁷³ In these sketches, the rotation platform appears behind the rafter, for better visibility of the maneuver. However, it should have been in front of the rafter, with the rafter lowered between the bottom masonry (or the rafter already in place) and the rotation platform displaced by the width of the rafter.

STRABO'S PORTCULLIS CHAMBER

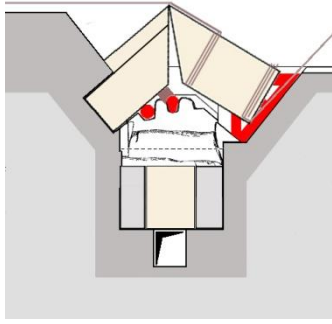

- the rafter continues to rotate, braked from behind by the counterweight and the shooting team.

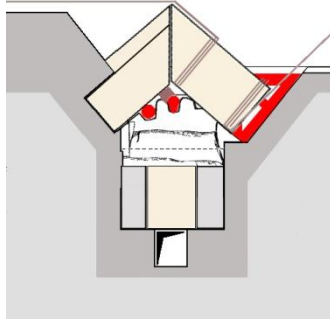

- the rotation of the rafter is completed, the counterweight and the team of pullers holding it in this position for a few moments.

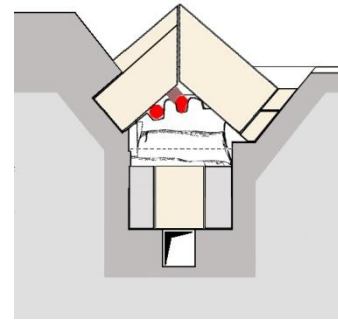

- a first shim is inserted under the bottom of the rafter, the ropes are removed and a second wedge is slid on to complete the locking of the rafter to its support.

Important note: as can be seen in the sketches above and the photos below, the East and West supports are not at the same level for the reason just detailed: the rafters on the East side arrive directly on their support, while those on the West side undergo a rotation; this could only be achieved by leaving a space between the foot of the rafter and the support, due to the greater length of the rafter measured on its diagonal. As for the rotation of the rafters on the West slope, evidence of a detail supporting this technique can be found at the foot of the South face of the pyramid, next to the pit of Khufu's solar boat: on the fifteen or so Turah limestone beams that covered the well, we can see that a rope must have been embedded in a channel dug in the axis of the beams in the two lower corners. Combined with the hole dug just above it, this must have been part of a beam handling process. Each rafter on the Western slope of the roofs of the two entrance chambers was to feature this type of channel and hole²⁷⁴ near the foot of the rafter to lock the ropes around it; from these, the braking ropes reached the counterweight blocks and the team of pullers controlling the rotation, as illustrated in the sketch of this maneuver shown above.



- the two wedges described in the last sketch above can be seen in situ at the foot of the lower right-hand rafter above the entrance.



- close-up view of the two wedges under the foot of the right rafter.
- the joints between these wedges and the rafter and its support are highlighted in red.

²⁷⁴ The ropes were clamped in the lower part by girdling the rafter and a piece of wood with a lug inserted in this hole.

STRABO'S PORTCULLIS CHAMBER



Alignment of fifteen Turah limestone beams used to cover the pit of Khufu's solar boat. Those still in good condition all have a hole and a gutter cut into the side faces on either side.



Close-up of a hole and gutter on one side of a beam.



Reminder: the two photos above were taken at the ancient Museum of the Solar Boat of Khufu at the base of the South face of the Great Pyramid. The Egyptians were masters in the art of rope-making.

STRABO'S PORTCULLIS CHAMBER

Longitudinal sections of the site.

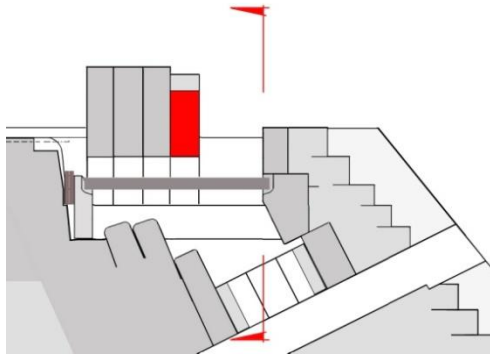

- Setting of the 4th West rafter in the middle of the chamber
- the 3 rafters in this section are lower and have a flat base, unlike those opposite.
 - they lean on the first 3 to block them.

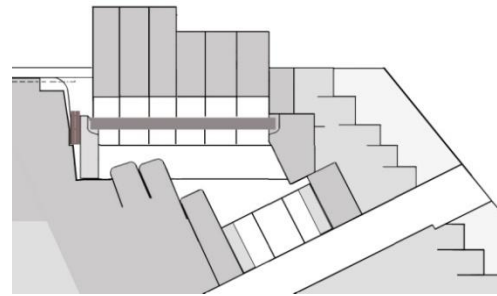

- The installation of 2 other rafters at the front is identical. Once the last rafter of the Eastern slope is in place, it is blocked by the masonry of the adjoining courses.

Cross-sections of the site.

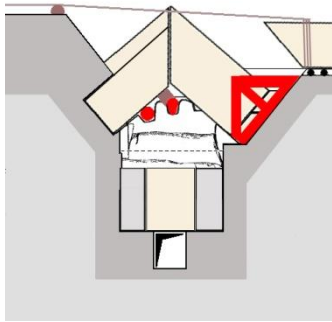

- the rafter was unloaded from the sled and pulled over rollers onto a wooden rotation platform.

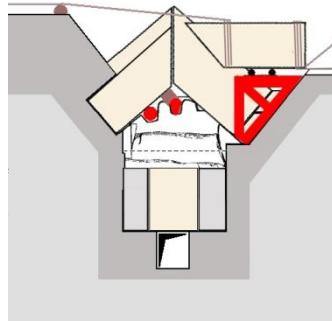

- the tip of the rafter is pressed against that of the rafter already in place.
- ropes tied to a post anchored in the pyramid's mass hold the rafter in place.

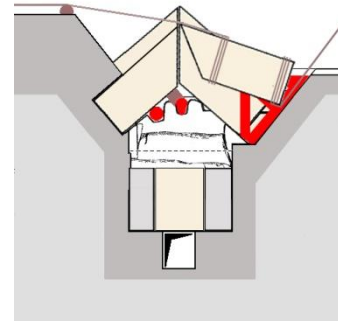

- the rotation of the rafter begins²⁷⁵, braked from behind by the counterweight and the team of pullers.

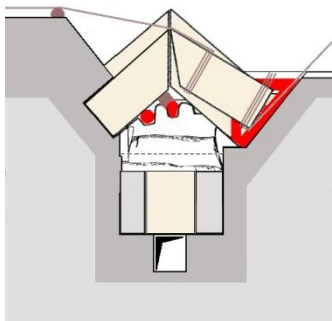

- the rafter continues to rotate, braked from behind by the counterweight and the pulling team.

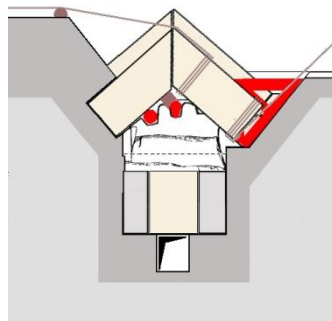

- the rotation of the rafter is completed, the counterweight and the team of pullers holding it in this position for a few moments.

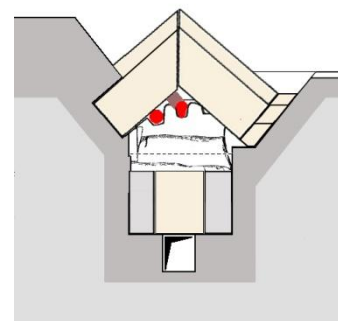

- a first shim is inserted under the bottom of the rafter,
- the ropes are removed and a second wedge is slid in.

²⁷⁵ In these sketches, the rotation platform is shown behind the rafter for better visibility of the maneuver. However, it must have been in front of the rafter after being moved.

STRABO'S PORTCULLIS CHAMBER

Completion of the roof of the first entrance chamber: removal of timbers and extraction of the Strabo Stone

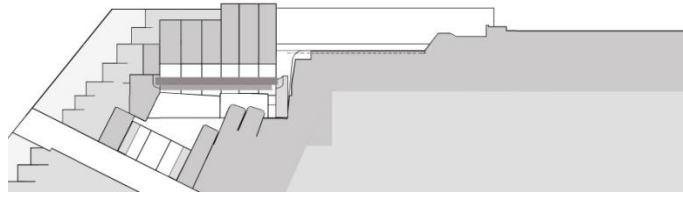

After dismantling and removing the triangulated intermediate frame and the locking pieces, the Strabo Stone is pushed back against the back wall, freeing the two long pieces of wood inserted in the notches.

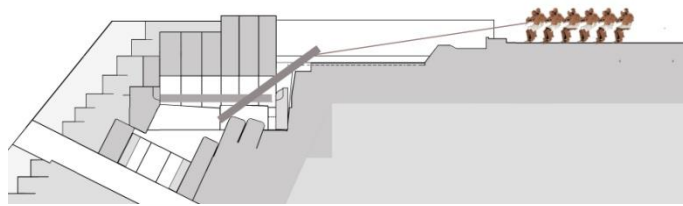

The first piece of wood from the center notch is evacuated through the triangular opening above the Stone.

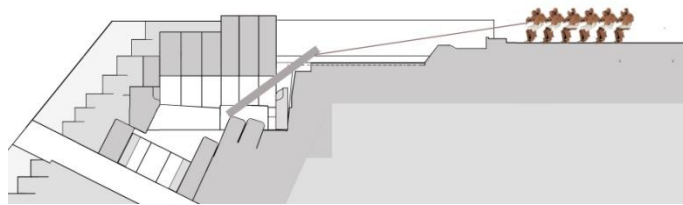

The second piece of wood from the East notch was also evacuated by the same route.

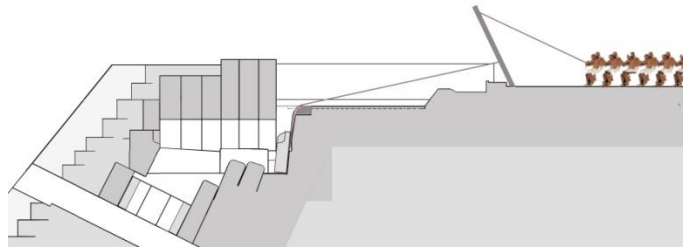

The Stone is now hoisted out of the first entrance chamber through a vertical well the width of the Stone and one cubit deep, to be temporarily stored flat at the rear of the first part of the future second chamber.

STRABO'S PORTCULLIS CHAMBER

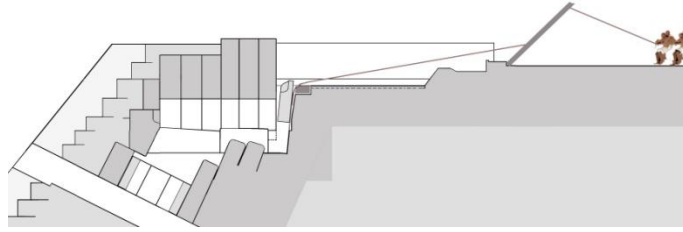

The Stone is hoisted into the vertical well behind the pair of lower rafters in the first chamber.

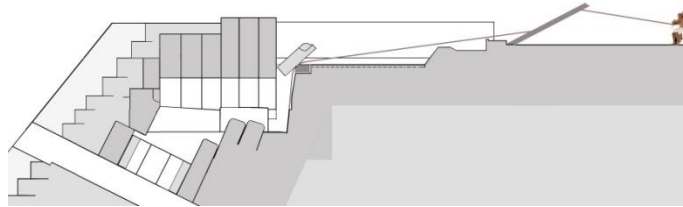

Once at floor level in the second chamber, the stone is tipped to lay flat on rollers arranged on a track on either side of the chamber.

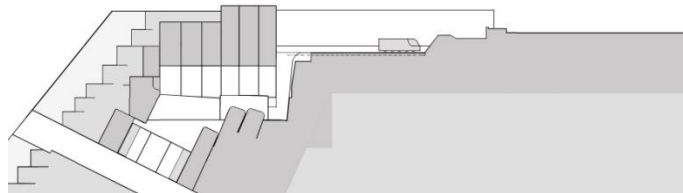

The stone is pushed to the rear of the first part of the second entrance chamber to be temporarily stored while a first part of the roof is built.

STRABO'S PORTCULLIS CHAMBER

Construction of the East side of the second entrance chamber:
1st section.
Longitudinal sections of the site

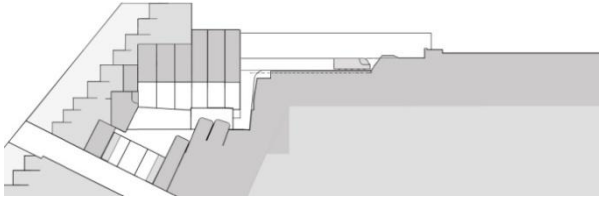

Before starting to lay the first rafter on the Eastern slope of the second chamber above the first chamber, 2 rows of blocks are built on the North side.

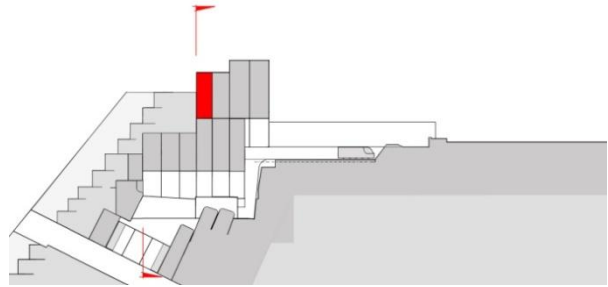

Setting of the 1st rafter (in red) on the Eastern slope of the second chamber above the first chamber. It is blocked against the masonry on the North side. Installation of the second rafter is identical.

Cross-sections of the site.

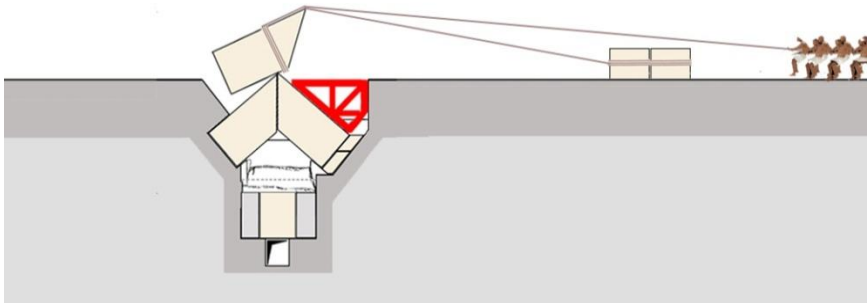

The rafter arrives on its transport sled. For the positioning maneuvers, the rafter is connected by ropes to a series of blocks acting as counterweights to slow its descent by dragging it over prepared ground. This considerably reduces the number of men needed to ensure a slow, controlled glide to the stop.

STRABO'S PORTCULLIS CHAMBER

Cross-sections of the site.

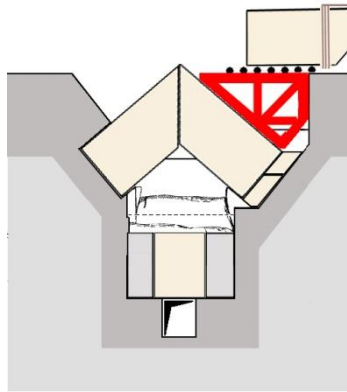

- the rafters arrive on rollers on the slightly sloping platform, pushed by a crew

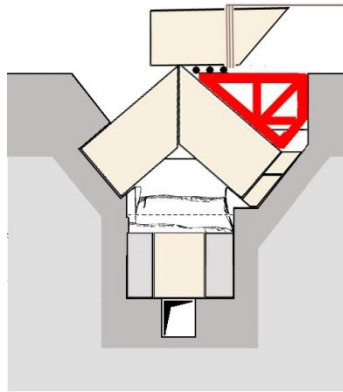

- the rafter approaches the point of rotation, the counterweight and pullers are ready to brake the rafter's rotation.

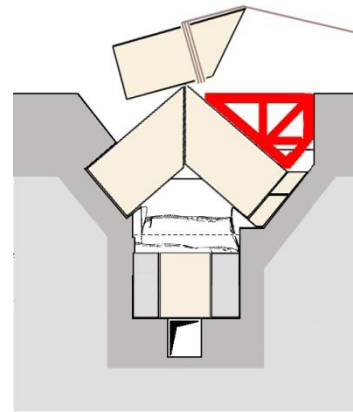

- the rafter begins to rotate, braked by the counterweight and the pullers.

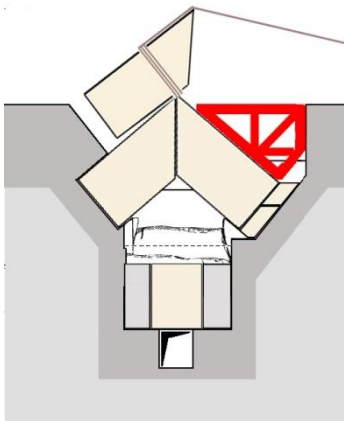

- the rafter is at the end of its rotation, braked by the counterweight and the pullers.

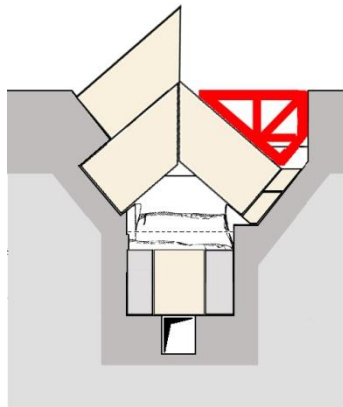

- the rafter is in place on its inclined stop and supported by the roof rafter of the first chamber.

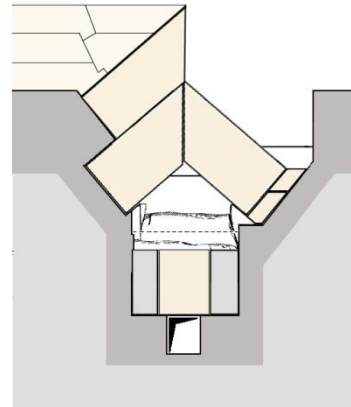

- to block the rafter, three rows of layers are built on the East side in a precise pattern.

STRABO'S PORTCULLIS CHAMBER

Construction of the East side of the second entrance chamber:
2nd section.
Longitudinal section of the site



- Installation of the 3^{ème} rafters is identical to that of the first two, the only difference being their higher height.

Cross-sections of the site.

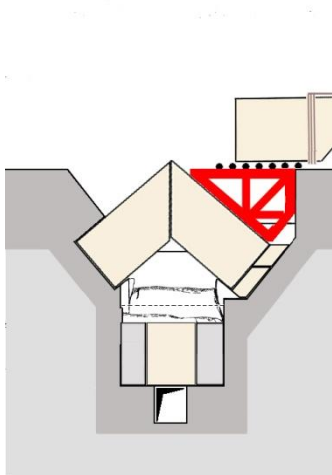

- the rafters arrive on rollers on the slightly sloping platform, pushed by a crew

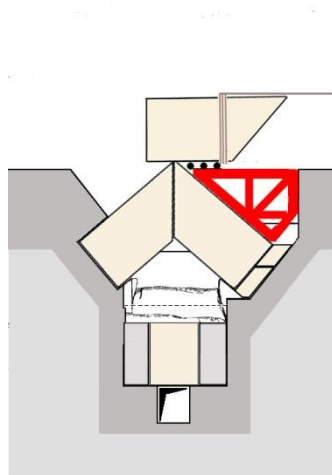

- the rafter approaches the point of rotation, the counterweight and pullers are ready to brake the rafter's rotation.

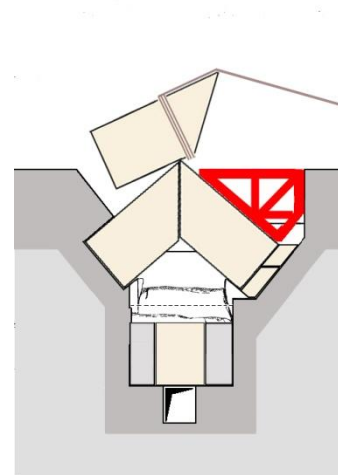

- the rafter begins to rotate, braked by the counterweight and the pullers.

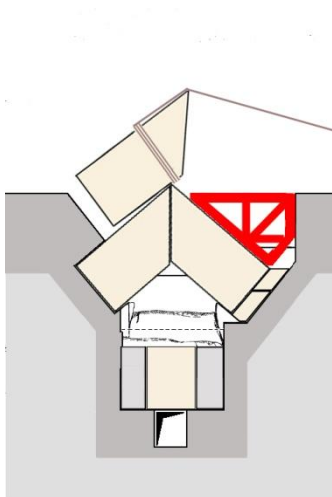

- the rafter is at the end of its rotation, braked by the counterweight and the pullers.

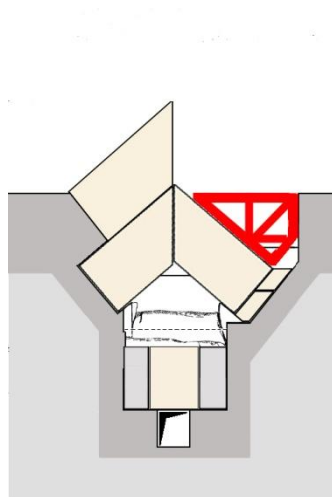

- the rafter is in place on its inclined stop and supported by the roof rafter of the first chamber.

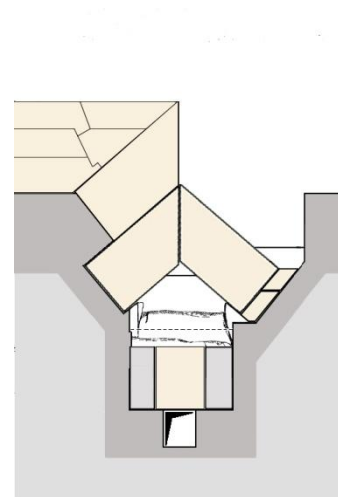

- to block the rafter, three rows of layers are built on the East side in a precise pattern.

STRABO'S PORTCULLIS CHAMBER

Details of the limestone block fitting above the upper left rafter (East-facing slope)



Block layout above the top left rafter

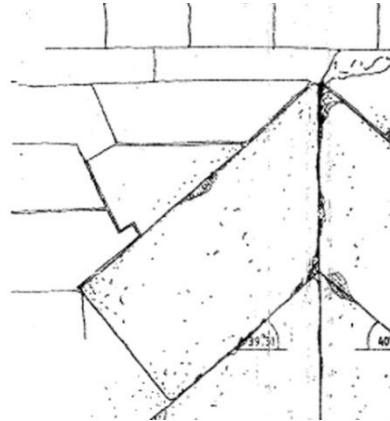

Gilles Dórmion plan

View of the limestone block fitting above the upper left rafter.
The rafter is perfectly blocked.

STRABO'S PORTCULLIS CHAMBER

Construction of the East side of the second entrance chamber:
3rd section.
Longitudinal section of the site

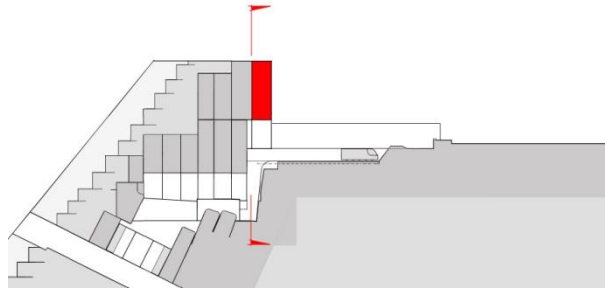

Installation of the 4th rafters (in red) on the East side of the second chamber.
It is held against the 3th rafters on the North side.
This section of a pair of rafters covers the connecting well between the first and second chambers.

Site cross-sections

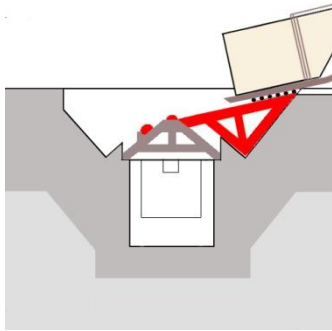

- the rafter transport sled arrives on rollers on the slide, braked by the counterweight and the pullers.

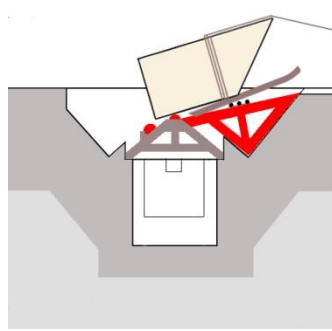

- the rafter is released from the sled and slowly glides to the vertical of the central piece of wood fixed to the²⁷⁶ installation jig spanning the well.

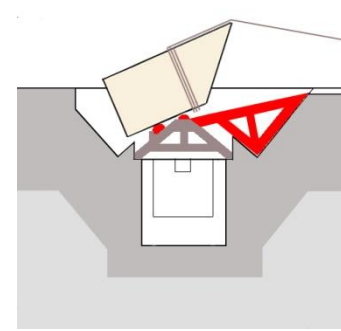

- With the sled removed, the rafter continues its descent, also resting on the second piece of wood.

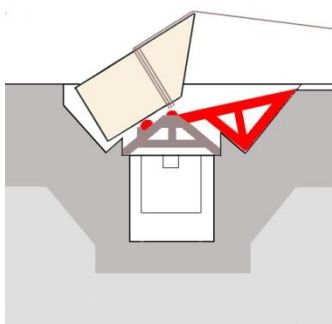

- the rafter rotates on the second piece of wood, its descent braked by the counterweight and the pullers.

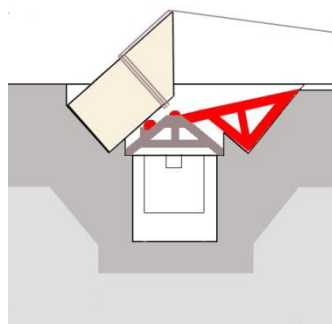

- the rafter now rests on the oblique stop and is supported by the second piece of wood.
- the ropes will be removed.

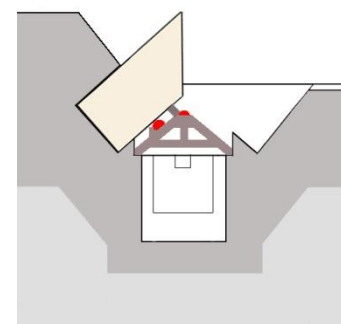

- a wooden wedge is inserted between the rafter and the template.
- three rows of layers are built to weigh on the bottom of the rafter and hold it in position.

²⁷⁶ This wooden installation jig performs the same functions as the Strabo Stone.

STRABO'S PORTCULLIS CHAMBER

Construction of the West side of the second entrance chamber:
1st section and 2nd identical sections.
Longitudinal section of the site

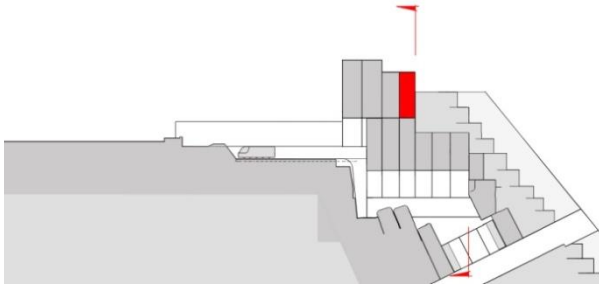

Setting of the 1st rafter (in red) on the first section of the West-facing slope of the second chamber above the first chamber. It is blocked against the masonry on the North side. Installation of the second rafter is identical.



Positioning the 3rd rafter (in red) of the second section of the West side of the second chamber above the first chamber. It is blocked against the rafters already in place.

Note: As the installation of the²⁷⁷ rafters is identical for the first 2 sections, the demonstration concerns the second section, which corresponds to the top left rafter visible above the entrance, as it allows us to see details of the limestone block fitting.

Site cross-sections

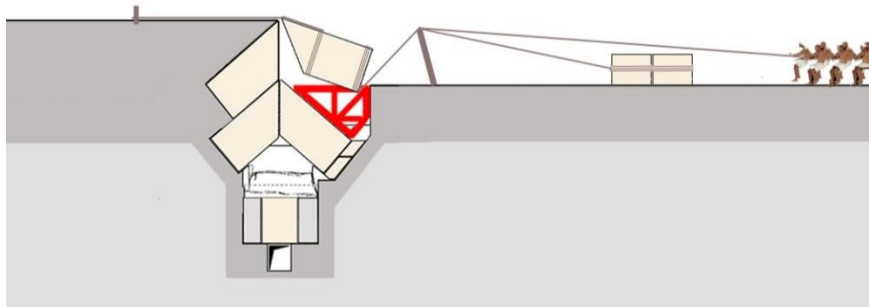

At the start of the installation maneuvers, the rafter is connected by ropes to a series of blocks acting as counterweights to slow down its rotation by dragging it over prepared ground. The front of the rafter is held under pressure against the head of the rafter on the Eastern slope, which serves as the axis of rotation. This considerably reduces the number of men needed to ensure slow, controlled rotation to the stop.

²⁷⁷ The only difference is that the rafters of the first section are lower.

STRABO'S PORTCULLIS CHAMBER

Site cross-sections

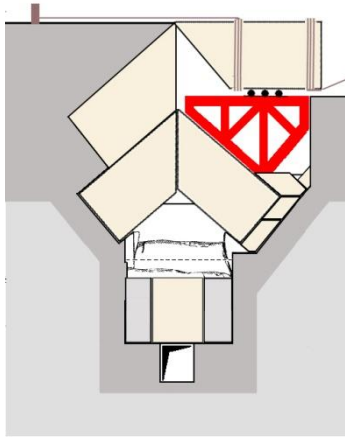

- the rafter is on the rotation platform, with its tip pressed against the rafter already in place.
- ropes tied to a post anchored in the pyramid mass hold the rafter in place.
- 2 wedges are in place at the bottom.

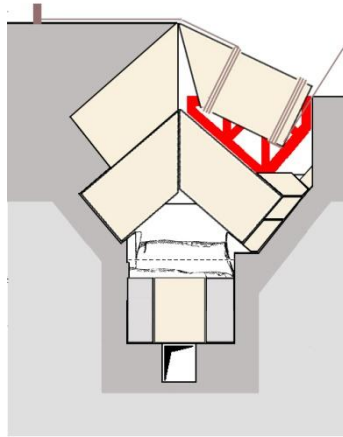

- the rafter is rotating, braked from behind by the counterweight and the team of shooters.
- the platform is pushed behind the rafter as shown in the sketch

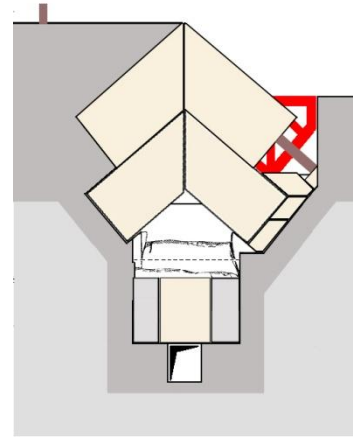

- once the rafter has been rotated, a temporary wooden wedge is placed at the foot of the rafter, resting on one of the wedges.
- the ropes are removed.

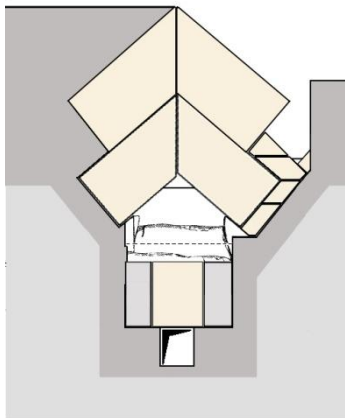

- a 3rd wedge is placed on top of the one already in place, blocking the rafter and allowing the wooden shim to be removed.
- the anchoring post is removed.

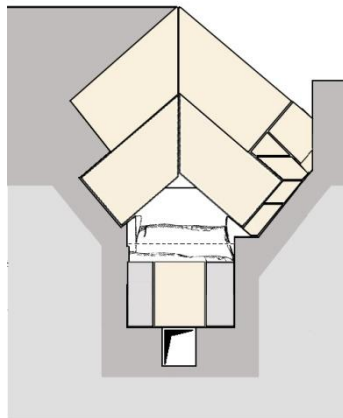

- a final wedge is slid over the 3 existing wedges, locking the rafter in place.

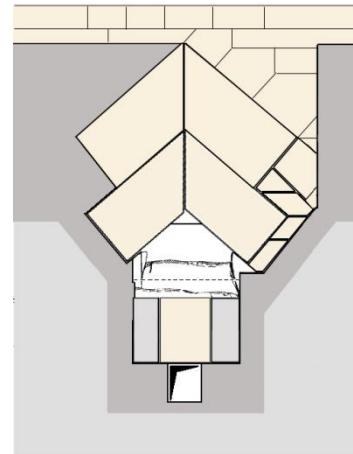

- three large blocks are laid obliquely against the rafters to restore the alignment of the layers.
- well-matched layers are built above the rafters.
- the West side layers are built to recover the level of the East side.

STRABO'S PORTCULLIS CHAMBER



View of the blocking wedges at the foot of the top right rafter:
 - the lower part is wedged first, using 2 wedges cut at an angle for 2-phase insertion.
 - a single block is used for the upper part.



Close-up on the wedging technique:
 - 2 beveled wedges at the bottom,
 - a perfectly cut block at the top,
 - below it, the wedge to receive the temporary wooden shim.



The blocks are fitted directly on the top of the top right rafter.

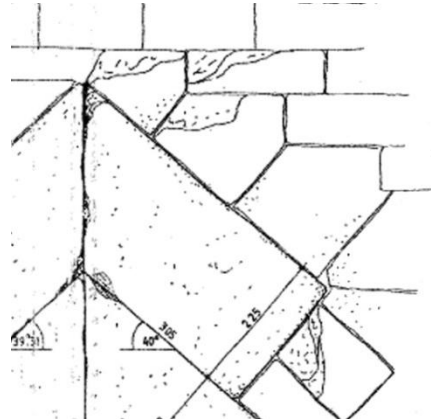

Gilles Dormion plan

View of the 3 oblique limestone blocks above the top right-hand rafter. They provide a link with the horizontal layers.

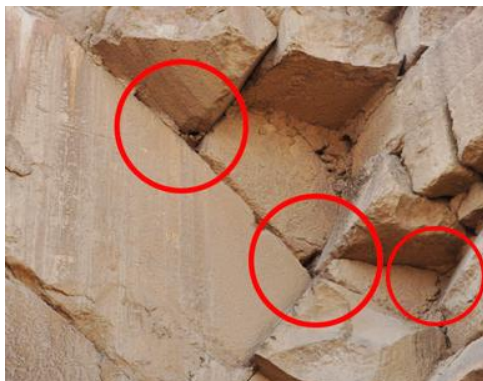

In the previous chapter on the ScanPyramids mission, one of the first anomalies²⁷⁸ discovered in the chevron zone is located to the right and above the lower upper face of the upper right chevron, where the first oblique limestone block is placed.

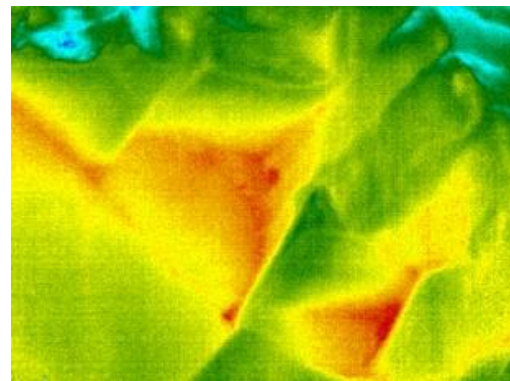

The thermal anomaly is perfectly localized and is the result of air circulation with very little temperature variation throughout the year. Three leaks are located in the blocking and wedging fitting, the escaping air being at the same temperature as the air inside the second entrance chamber and accumulating in two corners under two offset blocks.

²⁷⁸ See page 58.

STRABO'S PORTCULLIS CHAMBER



Back to the close-up of a hole and gutter on one side of a beam. This gutter turns over onto the adjacent face, leaving a gap between the rafter and its support over a certain length, potentially creating a passageway conducive to air leakage.

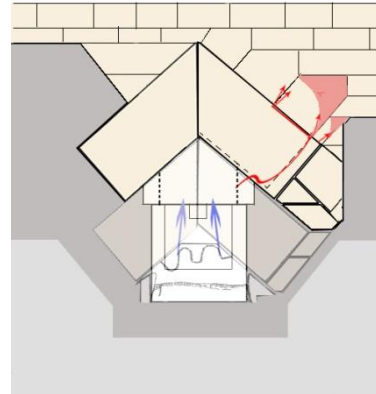

The origin of the air leak in this area could be linked to the gutter dug under the underside of the top right rafter just behind the rafter visible on the North face, to allow the rotation rope to pass through.

The air would then circulate between the oblique blocks and exit between the joints of the blocks visible from the façade. It has been established that air circulates between the outside and inside of the second chamber at the level of the connecting well between the two chambers, as demonstrated by the reaction of the Strabo Stone to infrared thermography.

Note: the endoscope used to uncover the second chamber was inserted into a gap behind the lower rafters.



Two other interesting details in the entrance area:

- the three rows of blocks above the second pair of rafters are made of perfectly-fitted Turah limestone. This height represents around 2.20 m, compared with the vertical distance, around 1.50 m, between the tip of the rafters and the base of the internal ramp that crosses above. There was nothing to prevent the use of less elaborate blocks on either side, apart from a special treatment of the space to accommodate the internal ramp.
- the vertical clear-cut (red line) on the West side (right) of the entrance, again using perfectly-fitted Turah limestone blocks, whereas on the East side (left), the blocks are staggered. This difference is consistent with the technique of installing the rafters on the West side only, as described in this chapter.

STRABO'S PORTCULLIS CHAMBER

Construction of the West side of the second entrance chamber:
3rd section.
Longitudinal section of the site

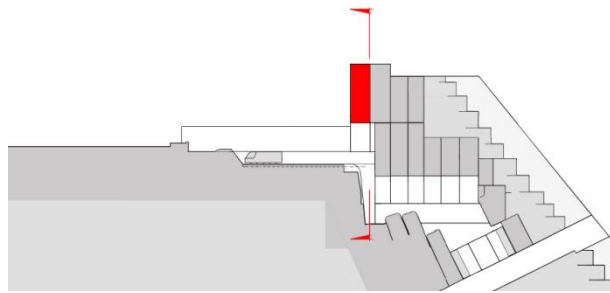

Installation of the 4th rafters (in red) on the West side of the second chamber above the first. It is blocked against the 3^{eme} rafters on the North side. This section of a single pair of rafters covers the vertical well linking the first and second chambers.

Site cross-sections

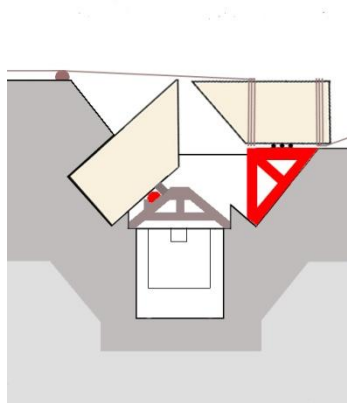

- the rafter is on the rotation platform, the tip of which will be pressed against the rafter in place.
- the ropes will be secured to a post anchored in the ground

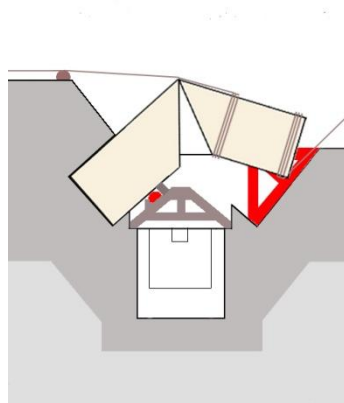

- the platform has been pushed behind the rafter as shown in the sketch
- the rafter is rotating, braked from behind by the counterweight and the team of pullers.

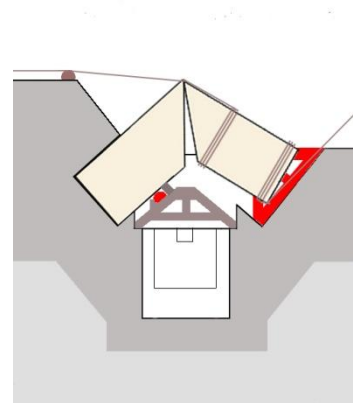

- the rafter continues to rotate, braked from behind by the counterweight and the pulling team.

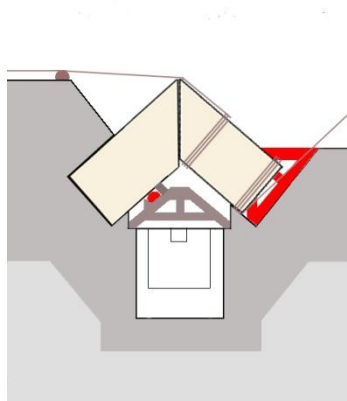

- the rotation of the rafter is complete, and it is held in this position for a few moments by the counterweight and the team of shooters
- Note: the Eastern rafter is wider than the Western one.

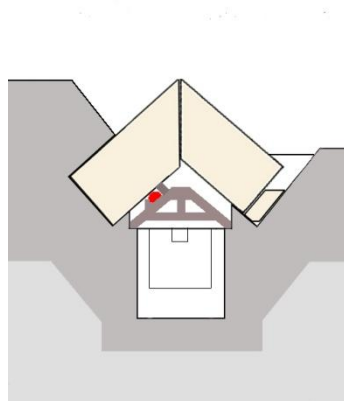

- a first wedge is inserted under the bottom of the rafter,
- the ropes have been removed and a second wedge will be inserted to complete the rafter blocking.
- the jig will be dismantled.

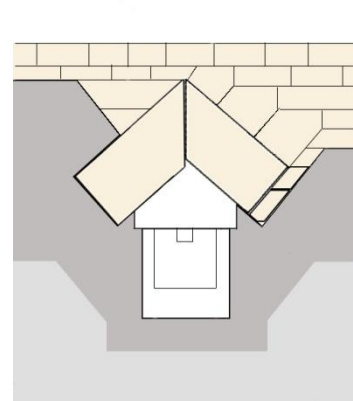

- the second wedge is in place.
- 3 large blocks are placed obliquely on the rafters to recover the alignment of the layers.
- well-bonded layers are built above the rafters.

STRABO'S PORTCULLIS CHAMBER

Construction of the East side of the second entrance chamber:
4th and 5th sections.
Longitudinal sections of the site

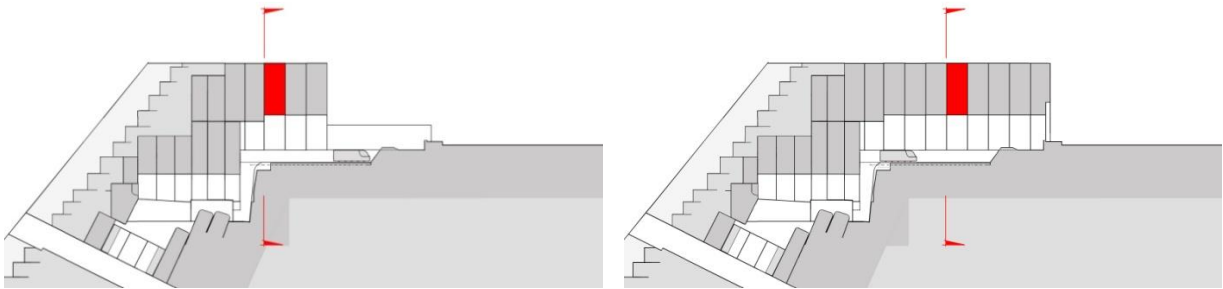

- the 4th section is made up of three pairs of rafters, covering around two-thirds of the first part of the second chamber. It ends before the temporary storage area for the Strabo Stone.
- except for the East rafter of the 3rd section above this well, all those in the second chamber are of the same type as the West rafter of the 3rd section.

- the 5th section consists of five pairs of rafters covering the rest of the roof of the second chamber.
- Prior to the construction of this last section, the Stone is pushed back to the front of the chamber, at the edge of the connecting well with the first chamber.

Site cross-sections

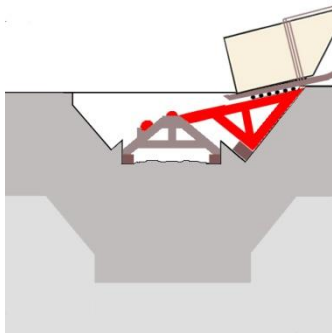

- the rafter transport sled arrives on rollers on the slide, braked by the counterweight and the pullers.

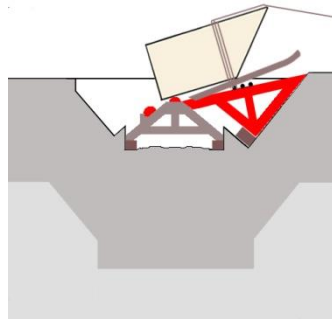

- the rafter is released from the sled and slides slowly up to the center piece of wood of the jig.

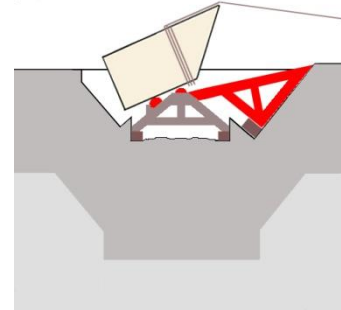

- With the sled removed, the rafter continues its descent, also resting on the second piece of wood in the jig.

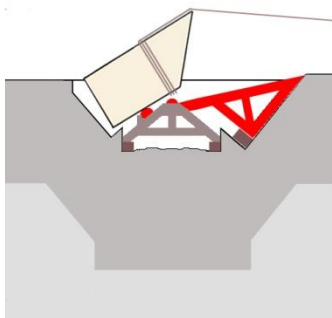

- the rafter rotates on the second piece of wood, its descent braked by the counterweight and the pullers.

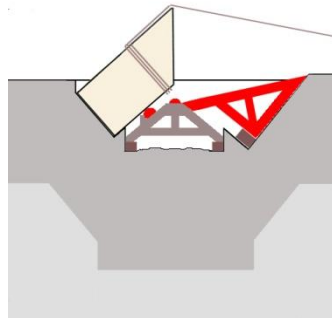

- the rafter now rests on the oblique stop and is supported by the second piece of wood.
- the ropes will be removed.

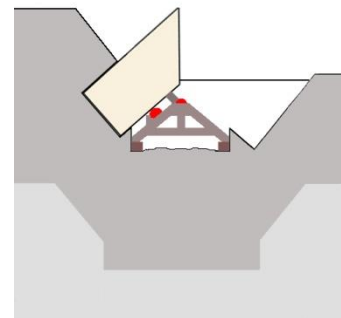

- a wooden wedge is inserted between the rafter and the template.
- three rows of layers are built to weigh on the bottom of the rafter and hold it in position.

STRABO'S PORTCULLIS CHAMBER

Construction of the West side of the second entrance chamber:
4th and 5th sections.
Longitudinal sections of the site

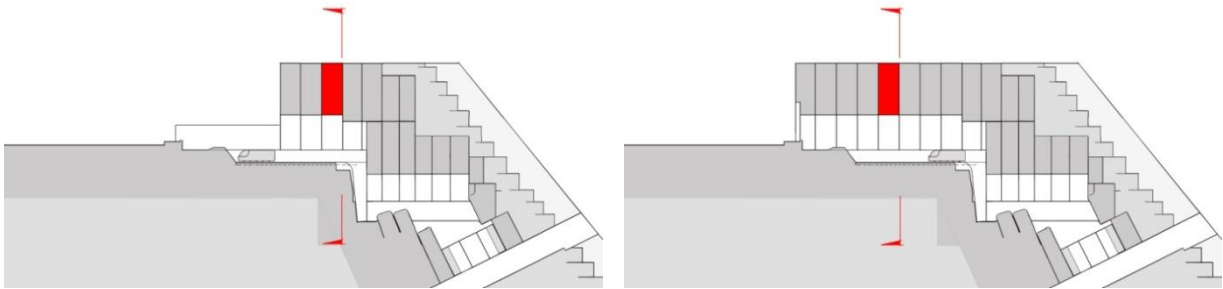

Setting of the 1st rafter (in red) on the 4th section of the West side of the second chamber.
It is held in place against the rafter.
The installation of the next two rafters is identical.

Installation of the 1st rafter (in red) on the 5th section of the West side of the second chamber.
Installation of the next 4 rafters is identical.

Site cross-sections

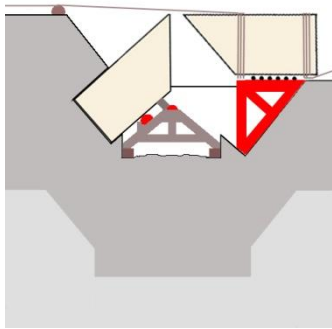

- when the rafter is on the rotation platform, its tip will be pressed against the existing rafter.
- the ropes will be secured to an anchored post.

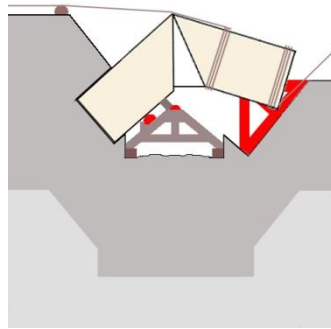

- the platform has been pushed behind the rafter as shown in the sketch
- the rafter is rotating, braked from behind by the counterweight and the team of pullers.

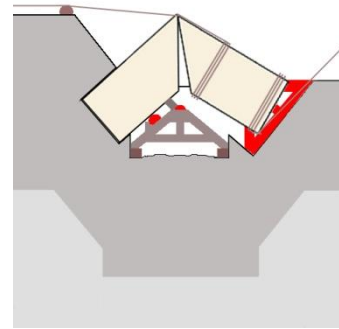

- the rafter continues to rotate, braked from behind by the counterweight and the pulling team.

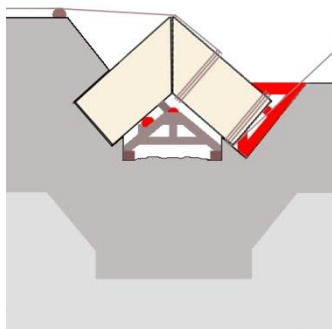

- the rotation of the rafter is complete, and it is held in this position for a few moments by the counterweight and the team of pullers

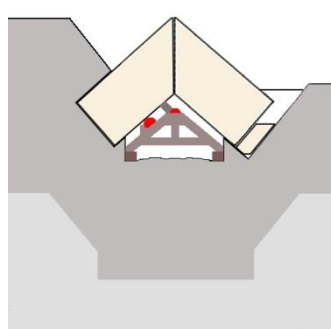

- a first wedge is inserted under the bottom of the rafter,
- the ropes have been removed.
- the jig will be dismantled.

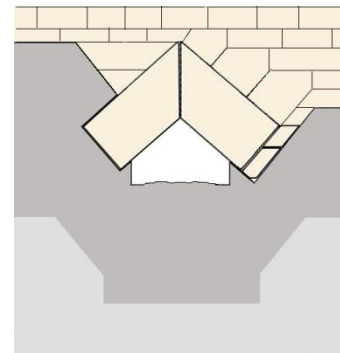

- the second wedge is in place.
- 3 large blocks are placed obliquely on the rafters to recover the alignment of the layers.
- well-bonded layers are built above the rafters.

STRABO'S PORTCULLIS CHAMBER

As we saw in this construction process, all operations were carried out on the West side of the site, leaving the East side completely free. The same process could perfectly well have been mirrored on the East side, leaving the West side free. In this case, the Western slopes would have been built first.

So why did the designers make this choice?

Quite simply to take into account, in the construction of the interior works²⁷⁹, of constraints resulting from the choices made for the construction of the pyramid's volume: an external ramp resting on the South face in the South-West part and an internal ramp starting in the South-East part of the same face and rising unclockwise in straight sections with quarter-turns.

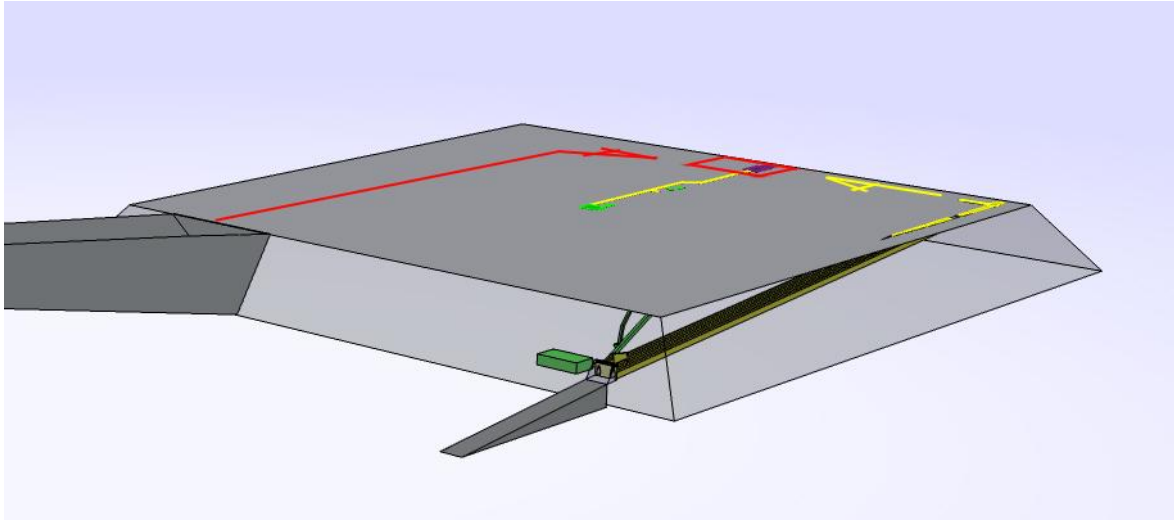

Site at +21 m level.

The Turah limestone rafters were delivered from the port of delivery:

- firstly towed up on the harbor ramp with the Plateau's counterweight.
- then hoisted onto the external ramp for delivery to the North-Western area (framed in red), where set-up operations were carried out.
- on the opposite side, the internal ramp could be developed without restriction (yellow arrow), the entrance chambers being covered while the internal ramp was still some twenty meters away.

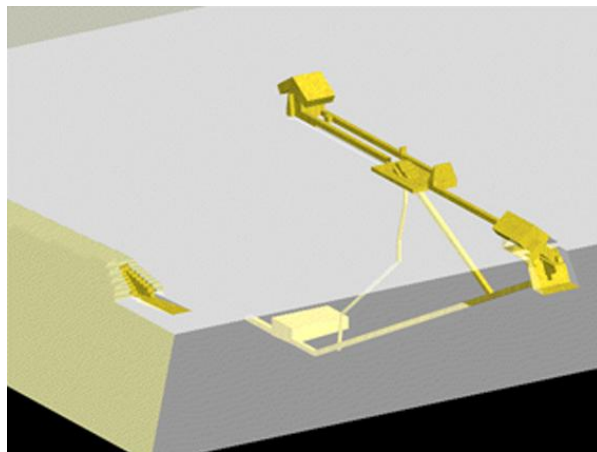

Site at +21 m level.

The internal ramp is the N°1 reason designers created the two entrance chambers with rafters roofing to reduce their height. The second chamber is more than 9 meters long, to leave enough free passage for this ramp by moving the start of the Noble Circuit further back.

²⁷⁹ The two construction sites within the same site, that of the volume and that of the chambers and corridors - See Memoir The BIG VOID, PREAMBLE page 2.

STRABO'S PORTCULLIS CHAMBER

Why did they build these two chambers?

The answer is very simple:

To create "official access" to a set of new corridors serving the known structures in the pyramid, the Queen's Chamber²⁸⁰ and the King's Chamber, as well as to other structures still unknown but for which we have proof of their existence, such as the BIG VOID (or rather a second Grand Gallery²⁸¹), or a very serious clue about them, such as one (or two) antechamber(s)²⁸² inserted on the route linking these entrance chambers to the King's Chamber.

When the roofs of the two entrance chambers were completed, the Strabo Stone was stored in the first part of the second chamber.



The roof ridge²⁸³ of the second entrance chamber is at level +25.53 m, and the floor behind it can be estimated at level +21.15 m,²⁸⁴ the same as the floor of the Queen's Chamber.

By extending the overall width of the second chamber beyond the "back wall" by 7 cubits, the space between the two levels in this rear area corresponds to a construction trench of the same type as that in which the other corridors were built using the Egyptian technique of the time.



To the rear of the second entrance chamber, behind the vertical slabs visible at its far end, the architects began construction of the second horizontal corridor, leading to the Queen's Chamber, and the second ascending corridor, leading to the King's Chamber and the second Grand Gallery; this is the Noble Circuit set of corridors described in Chapter 6.²⁸⁵ The level of the horizontal corridor is identical to that of the floor of the Queen's Chamber, which is approximately 78 m from the rear face of the closing slabs at the back of the second chamber.

²⁸⁰ And through it and the new corridor serving it, two direct entrances to the well-known Grand Gallery.

²⁸¹ See Memoir The BIG VOID.

²⁸² And the internal ramp crossing just above the second chamber.

²⁸³ i.e. the highest point where the rafters of both sides of the roof meet.

²⁸⁴ The known horizontal corridor has 2 levels: + 21.67 m in its first part, + 21.15 m in the second near the Queen's Chamber. The second horizontal corridor may also have its first section at an intermediate level.

²⁸⁵ See chapter 6, page 43 to page 53.

STRABO'S PORTCULLIS CHAMBER

As I wrote earlier in this chapter²⁸⁶ :

"That said, in the case of the two entrance chambers, the roofs are built with a basic constraint in mind: the "boundary" between the roof of the first and that of the second is decisive, as it is linked to the two functions that the architects gave to Strabo's Stone".

The first function of the Stone, linked to the construction of the first chamber, had been completed, but it would now wait for years, stored at the edge of the connecting well between the two chambers, for the day when it would again be called upon for its second function: the sealing of the Noble Circuit at the end of King Khufu's funeral. In anticipation of this day, the architects still had some preparatory work to undertake: the storage in the second chamber of all the components needed to close the pyramid, which was to be made with the Stone that became "STRABO'S PORTCULLIS" for the occasion. The handling of a limestone block of this weight was further proof of the incredible skill of the designers.

The technique will be explained in a later chapter.

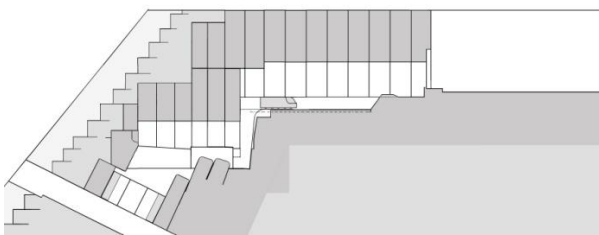

The Stone waiting at the edge of the connecting well between the two chambers.



The components needed to seal the Noble Circuit are placed in the trench behind the second chamber.



All components are now stored in the second chamber in a very precise order of use. The floor of the room was left in its original condition, as it was under the Stone, with the slabs and limestone blocks stored.

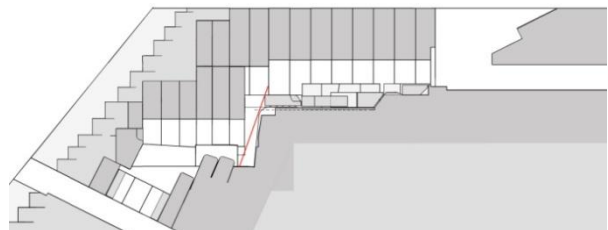

Construction work on the Noble Circuit has begun. A ladder (in red), coupled with a parallel slide²⁸⁷, allows access from the first to the second chamber.

Finally, from this stage onwards, the entrance to the Noble Circuit will be used mainly by members of the project management team, architects, engineers and other officials, and by the King and high dignitaries during visits to the construction site, for the duration of the pyramid's construction.

²⁸⁶ See page 87.

²⁸⁷ This ladder and the parallel slide were secured to the ground by wooden pegs inserted in holes dug in front of the Stone - see details on page 52.

STRABO'S PORTCULLIS CHAMBER

10 - APPEARANCE OF THE TWO ENTRANCE CHAMBERS ON THE EVE OF THE FUNERAL

In the penultimate paragraph of the previous chapter, I wrote:

"...the storage in the second chamber of all the components needed to close the pyramid, which was to be made with the Stone that became "STRABO'S PORTCULLIS" for the occasion. The handling of a limestone block of this weight was further proof of the incredible skill of the designers".



The components needed to seal the Noble Circuit are placed in the trench behind the second chamber.



All components are now stored in the second chamber in a very precise order of use. The floor of the room was left in its original condition, as it was under the Stone, with the slabs and limestone blocks in storage.

For the storage of beams and rafters for the superstructure to be built above the King's Chamber, I wrote in my Memoir on The BIG VOID²⁸⁸ :

"Starting in the summer of 2018, pending further results, I devoted myself to refining the configuration of the GG2 and reconstructing the likely optimal sequences for hoisting the monoliths from the temporary storage area at the foot of the external ramp until the end of the construction of the King's Chamber and its superstructure.

At first glance, this might seem unimportant, but the success of the solution devised by the designers was based on a succession of very precise hoisting sequences for the monoliths, with the position of the beams of each ceiling and the roof at each transfer conditioning their placement when the time came. As an example, Phase 1B, the hoisting of the sixty-five monoliths from the base of the external ramp to the storage area at level +43m on the South face: the sequences distribution of transfer of the monoliths from my 2011 theory version had to be modified with the introduction of the GG2; the old grouping of beams no longer met the constraints of the setting sequences above the King's Chamber and the available space. This shows the degree of organization of the site by the designers, nothing being left to chance".

The last sentence applies perfectly to the storage of the components that would be used to seal the Noble Circuit after King Khufu's funeral. The "FORM" of the second entrance chamber²⁸⁹ had been optimally designed to store the Strabo Stone, limestone blocks for the counterweight system used to lower it, reinforcing blocks under the rafters and²⁹⁰ blocking and closing slabs.

²⁸⁸ The first two paragraphs at the top of page 44.

²⁸⁹ Following the discovery of the SP-NFC, the "Form" of the first entrance chamber is unchanged from my January 2011 proposals, as it is still perfectly suited to its "FUNCTION". The reconstruction that has been made is difficult to contest.

²⁹⁰ To block any attempt to raise the Stone at the front of the second chamber and to wall it off from the rear, closing off access to the Noble Circuit.

STRABO'S PORTCULLIS CHAMBER

In the previous chapter, on pages 98 and 99, I explained how the Strabo Stone was extracted once its primary function had been fulfilled: to support the timbers used to build the chevrons roof of the first entrance chamber.

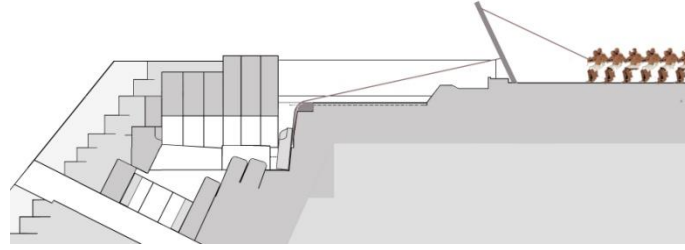

As the second entrance chamber had not yet been built, the men in charge of this operation had all the space they needed to pull the stone; moreover, the use of a technique based on the lever principle minimized the number of men required. To pull the Stone, a set of ropes was attached to an anchor point dug into the back of the Stone, in its axis and just below its center of gravity. The same configuration was applied again when the Stone was put in place for its second function, to become the PORTCULLIS for sealing the passage between the two chambers.

Note: The anchoring point is symbolized in the sketches of the Portcullis descent kinematics below.

Kinematics of the descent of Strabo's Portcullis, the reverse operation of Stone extraction.

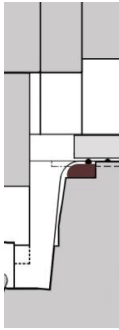

The Portcullis is in its storage position after the construction of the 4th roof section²⁹¹.

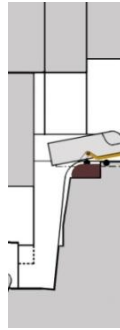

The ropes are attached to the anchoring device dug into the back of the Portcullis.

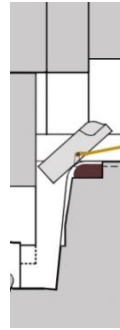

The tilting of the Portcullis has begun; the ropes are under tension, connected to the traction bar.

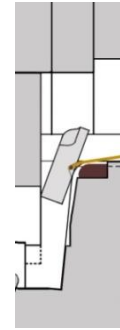

Rotation is aided by the position of the anchoring point, just below the Portcullis's center of gravity.

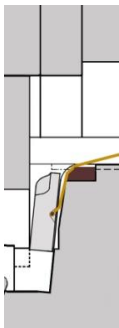

The Portcullis is slowed down by counterweights and friction on the walls of the well/housing. Braking is completed and controlled by 4 men holding other ropes.

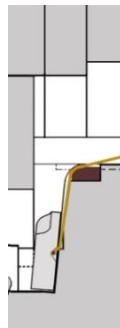

The Portcullis is placed on a slightly sloping part of the well/housing floor. Once the Portcullis has been lowered, all that's left to do is slide it under the rafters.



The Portcullis is tilted forward to rest on the flat ground of its final support, which is perfectly smooth²⁹².

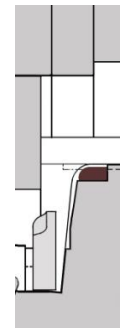

The Portcullis is pushed forward by means of levers from the second chamber; the small contact surface makes maneuvering easier. It is now locked under the lower rafters.

²⁹¹ See sketch at top of page 101.

²⁹² See Gilles Dormion's plans on page 52.

STRABO'S PORTCULLIS CHAMBER

This meant that the Stone/Portcullis had to be on the edge of the well's upper opening before it could be lowered into the well. That said, unlike its previous extraction, there was little room to hold back the descent of this several-ton block²⁹³, an operation that could only be carried out with the help of counterweights and a few men. The size of the second chamber would be conditioned by these imperatives, in addition to the passage of the internal ramp above it.



The size of the second chamber was determined by the components required to seal it, and the need to transfer part of the sarcophagus to a transversal position. Two flat lateral strips (shown in yellow below) some sixty centimeters wide were required for the counterweight system implemented.

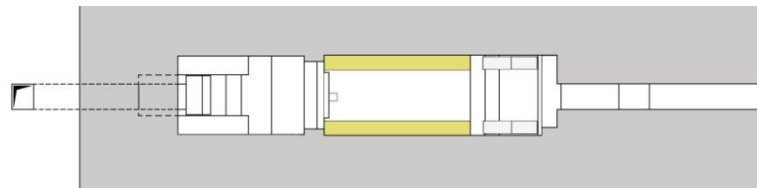

The second chamber and the start of the Noble Circuit with all the moving parts needed to seal it.

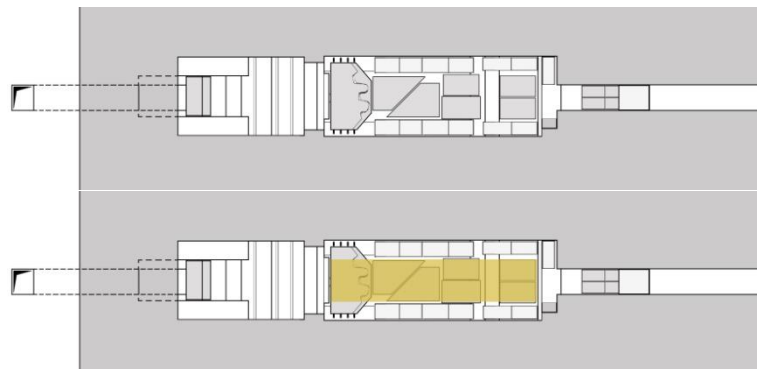

For the duration of the work, and right up to the funeral, the components on the floor were protected by mats (in yellow).

²⁹³ See footnotes on page 83.

STRABO'S PORTCULLIS CHAMBER

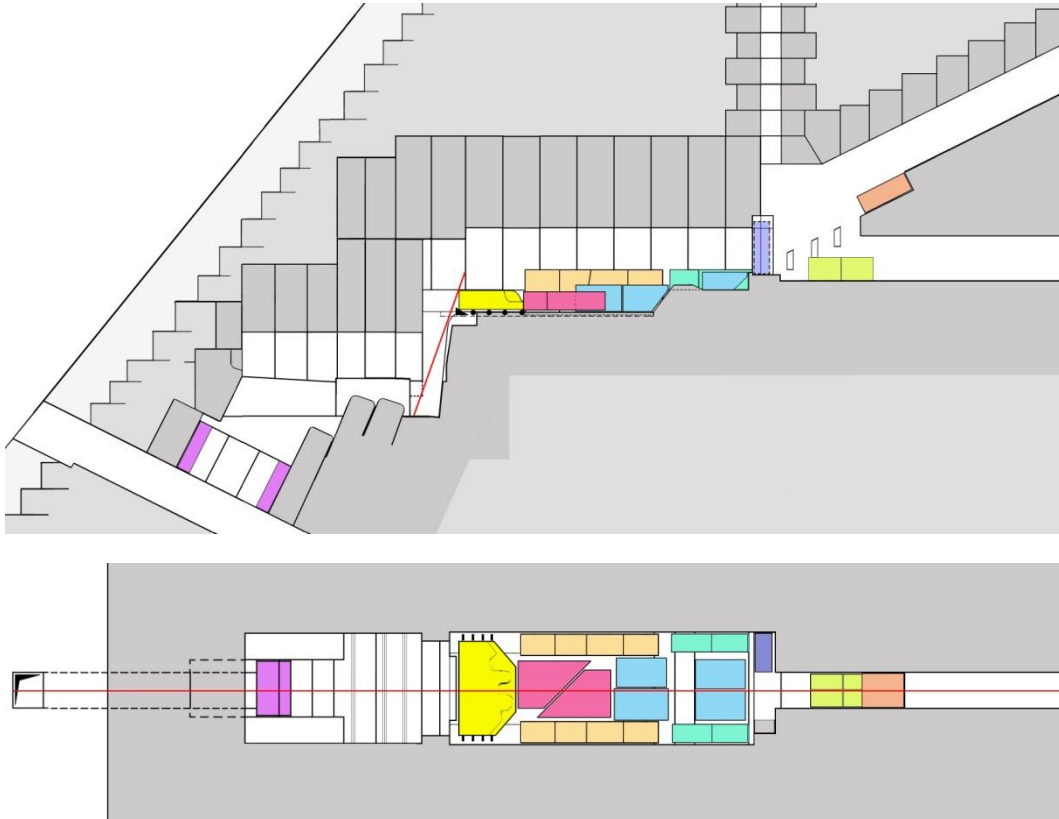

Visual marking of the main components stored inside the two entrance chambers and at the start of the Noble Circuit, which will be involved in sealing the latter after King Khufu's funeral.
Below is the color nomenclature and the role of each component:

- Strabo's Stone / Portcullis.
- The two vertical slabs behind the rafters and laid on the blocks on Strabo's Portcullis.
- The side blocks under the rafters are stored in the center of the chamber to make room for the counterweights.
- The side blocks under the rafters are set in place to their final position as soon as the chamber is built.
- The side blocks under the rafters which will be used as counterweights, sliding/crushing on the side strips.
- Blocks placed directly on Strabo's Portcullis waiting in the Noble Circuit.
- A closing slab between the chamber and the Noble Circuit waiting at the base of the ascending corridor 2.
- A slab to close off the passage between the chamber and the Noble Circuit, waiting in its lateral housing.
- One of the two slabs closing off the well between the descending corridor and the first entrance chamber.
- The plugging block for the descending corridor on the North face.

The nomenclature is designed to make the following two chapters easier to read.

STRABO'S PORTCULLIS CHAMBER

11 - PATH OF THE SARCOPHAGUS DURING THE FUNERAL PROCESSION

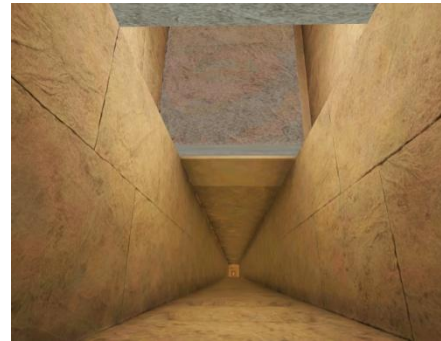
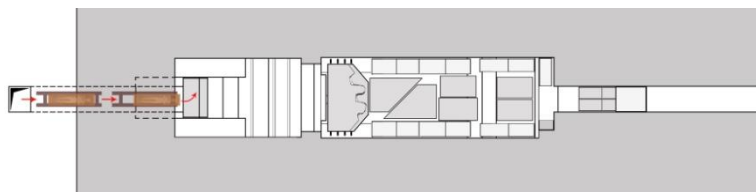
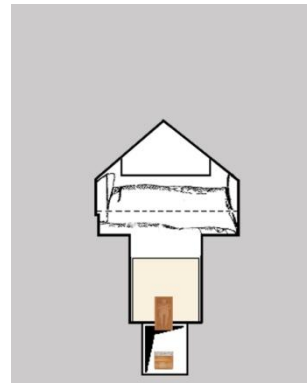

Descending corridor and connecting well.

The sarcophagus, placed on a special sled, is introduced into the descending corridor. Once under the connecting well to the first entrance chamber, it is uncoupled from the sled and begins its journey through the chambers.

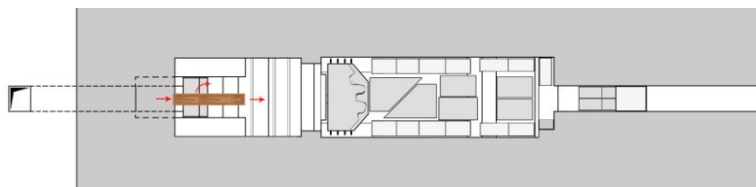
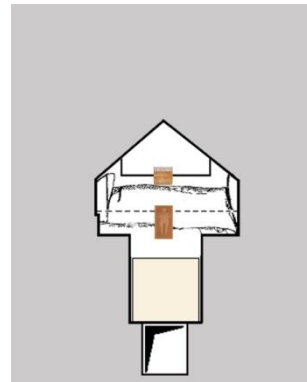

The first entrance chamber and the connecting well to the descending corridor.

The sarcophagus emerges from the well and enters the first entrance chamber. It is still transported **longitudinally**.

STRABO'S PORTCULLIS CHAMBER

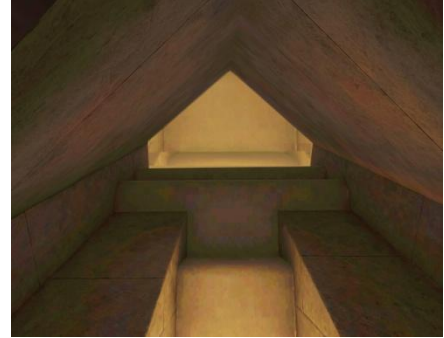
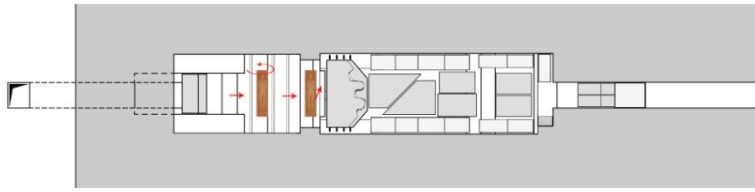
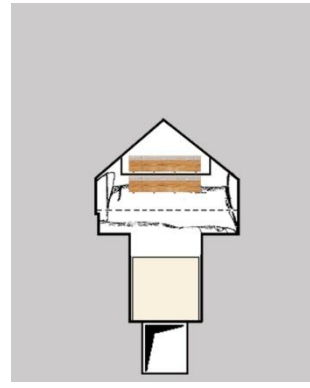

The recess in the wall at the bottom of the connecting well to the second chamber.

The sarcophagus was turned **transversely** in the first chamber and inserted at the bottom of the connecting well with the second chamber. A twenty-centimeter-deep, two-and-a-half-meter-wide recess in the bottom wall provides more space for the vertical transfer of the sarcophagus, without affecting the lowering of Strabo's Portcullis.

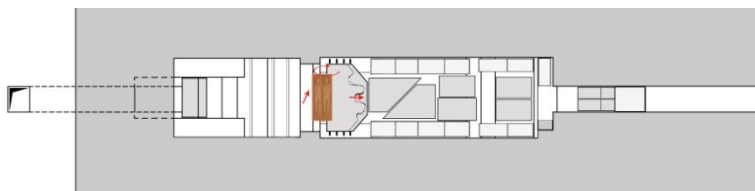
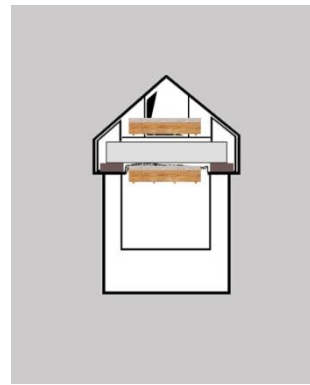

The second chamber as revealed to the public on March 2, 2023.

The sarcophagus emerges from the connecting well into the second chamber. Halfway up the second chamber, it is turned again, back in the **longitudinal** direction. The rotation of the sarcophagus in each chamber has imposed their width.

STRABO'S PORTCULLIS CHAMBER

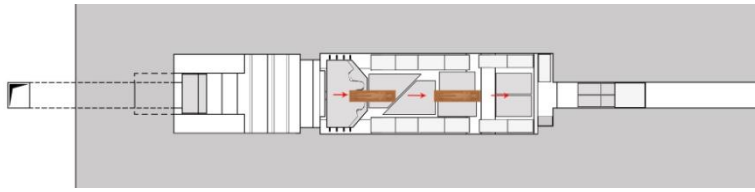
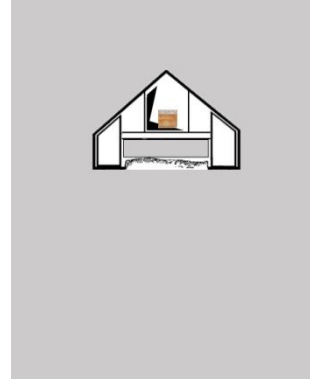

The second chamber as revealed to the public on March 2, 2023.

The sarcophagus is now transported to the rear of the second chamber to be brought closer to the start of the Noble Circuit.

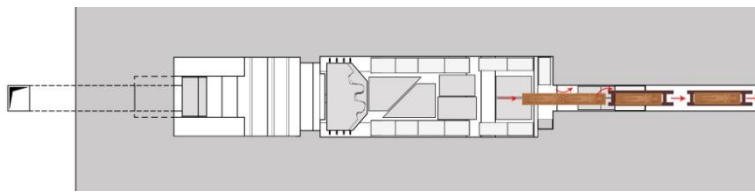
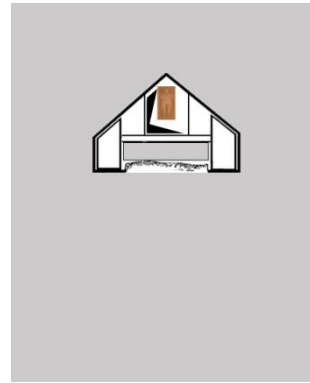
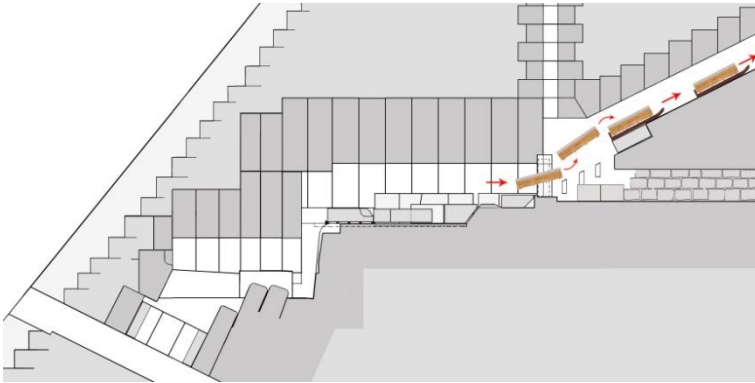

The passage between the second chamber and the start of the Noble Circuit.

The sarcophagus is introduced into the Noble Circuit towards the N°2 ascending corridor. Meanwhile, the transport sled has been transferred down it. The sarcophagus is then reset on it to continue its journey to the tomb²⁹⁴.

²⁹⁴ The rest of the journey to the tomb will be described in the 3rd Memoir of the trilogy: "Khufu's Pyramid, recent discovery of a cavity under the North-East edge by the ScanPyramids mission".

STRABO'S PORTCULLIS CHAMBER

12 - SEALING THE SECOND ENTRANCE WITH STRABO'S PORTCULLIS

Location on a ScanPyramids photo of the components²⁹⁵ for the sealing of the Noble Circuit.

This photo shows only part of the second Entrance Chamber as it stands after sealing; Strabo's Portcullis, the centerpiece of the system, and its vertical locking slabs are shown on two sketches in their storage position.

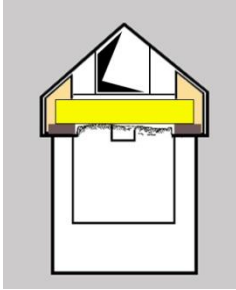

Strabo's Portcullis stored on rollers above the rough floor of the chamber.



The blocks of the counterweight system. Before the portcullis was lowered, they were pushed back to the level of the beam running through the chamber.



The blocks were stored in the center of the chamber to give the counterweight the necessary length of travel when braking the descent of Strabo's Portcullis.

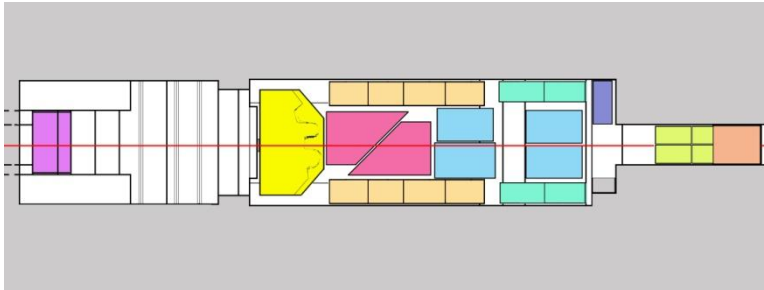

Plan of the layout of all the components used prior to sealing the access to the Noble Circuit with the centerpiece, Strabo's Portcullis. Before the Portcullis is lowered, the counterweight blocks are pushed back by the length required for the maneuver, the space being gained by moving several blocks to the center of the chamber.



Blocks already in their final positions. These are the blocks laid from the beam across the chamber to the rear of the chamber.

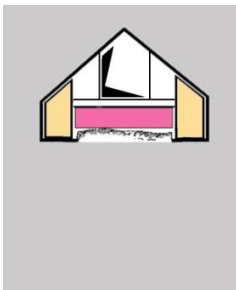

Vertical slabs stored in the center of the first part of the chamber, between the Portcullis and the displaced blocks (blue blocks).



The vertical slab already in place at the bottom of the chamber, which will be pushed slightly after the slab stored in the Noble Circuit has been put in place.



The vertical slab that seals the access to the Noble Circuit, and which is stored in this circuit until it is installed.

²⁹⁵ For colors, see also the nomenclature at the end of chapter 10, page 118.

STRABO'S PORTCULLIS CHAMBER

Sealing the entrance to the Noble Circuit.

Note: I imagine that the second horizontal corridor was filled in²⁹⁶ between the second chamber and its change of axis, ending up in the North-West corner of the North wall of the Queen's Chamber. This work would have been carried out during the King's seventy-day mummification procedure.

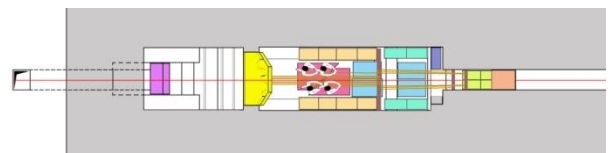
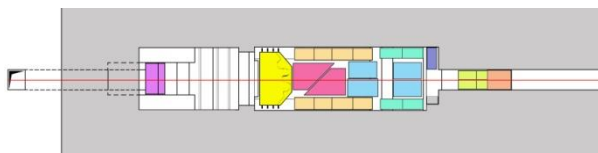

The funeral procession is over, and the Priests have left the pyramid in the opposite direction to the funeral procession. Sealing of the two chambers begins. The Portcullis is laid flat in the second chamber.

Two rope lines are connected to the pull bar of the side counterweight blocks, and 4 men are in their places. The Portcullis is pushed to the edge of the well before it tips over. The southern edge of the ground blocks has been rounded and a wooden rope return piece has been inserted into the notch cut in the well axis to facilitate descent²⁹⁷.

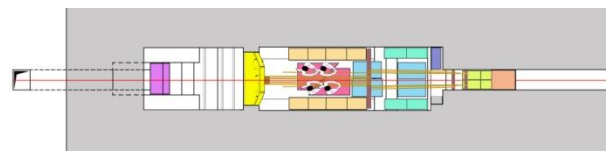
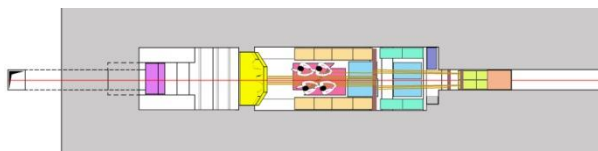
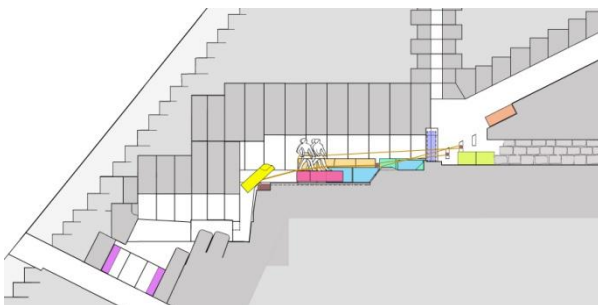

The ropes are attached to the device dug into the back of the Portcullis²⁹⁸, below the center of gravity. As the ropes are now taut, the Portcullis begins to tip into the well. In addition to the braking provided by the counterweight, the 4 men use the 2-strand technique to brake the descent by holding on to 2 ropes wrapped around 2 logs²⁹⁹ inserted in the side walls holes at the start of the Noble Circuit.

The Portcullis is now on its way down in the well, its tilting having been facilitated by the rope anchorage point below its center of gravity. The lateral counterweight blocks move forward on the lateral strips prepared on the floor, their friction on this one plus that of the Portcullis against the well walls providing 95% of the braking; the 4 men provide the rest and above all control the operation.

²⁹⁶ Like the West descending corridor of the Bent pyramid at Dahshur, reopened in 1951 by Egyptologist Ahmed Fakhry.

²⁹⁷ For details of this and the following six sketches, see the kinematics of Strabo's descent of the Portcullis in the previous chapter, page 116.

²⁹⁸ Which was used to extract the Strabo Stone at the end of construction of the first chamber.

²⁹⁹ Using a technique known from the Old and New Kingdoms. See Building in Egypt, Pharaonic Stone Masonry - Dieter Arnold - Oxford. Fig. 3.20, page 73.

STRABO'S PORTCULLIS CHAMBER

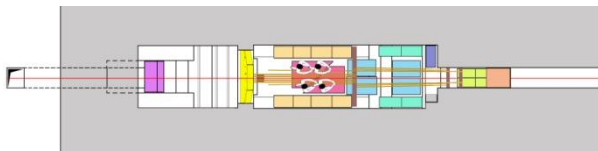

The Portcullis is halfway down the well. The lateral counterweight blocks continue to advance towards the well, rubbing on the prepared side strips on the floor; the 4 braking men are still maneuvering.

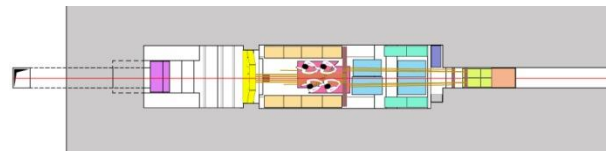

The Portcullis lays on the sloping part of the well floor. The lateral counterweight blocks have arrived at their final destination at the edge of the well, and all the ropes have been removed. The rear part of the side strips is ready to receive the blocks stored in the center of the chamber. The mission of the 4 braking men is over.

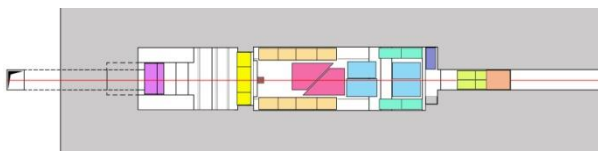

The Portcullis is tilted forward by means of levers to rest on the flat area prepared under the lower pair of rafters; sand has been sprinkled to facilitate pushing under the rafters.

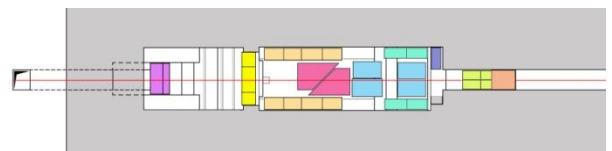

The Portcullis has arrived at its final destination, partly inserted under the lower rafters. Complementary operations for tamper-proof sealing of the access to the Noble Circuit are about to begin, with the two chambers now separated.

STRABO'S PORTCULLIS CHAMBER

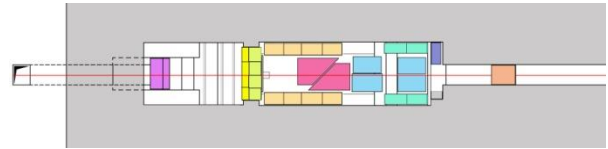
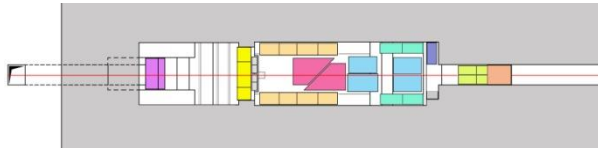
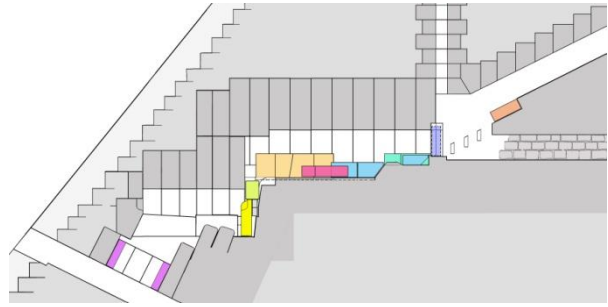
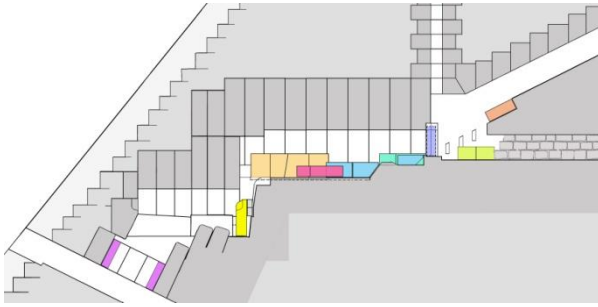

The rest of the operation is carried out by two teams, one in each chamber. The team of the second locks the Portcullis in a vertical position under the rafters, with small limestone blocks inserted between its rear face and the 20 cm recess in the well wall; mortar is used.

The same team places the four blocks stored in the Noble Circuit on a bed of mortar spread over the top of the Portcullis. The open space above it is then filled in. For its part, the team of the first room ensures the finishing of the visible joints.



View of the masonry laying on the Portcullis. The two blocks are not aligned due to the conditions under which they were laid.



On the right-hand side, a protrusion of mortar proves that it was laid from inside the second chamber.

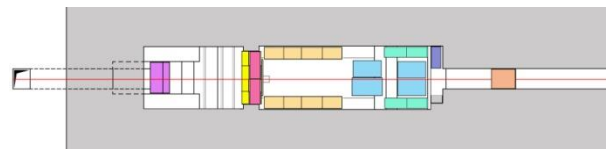
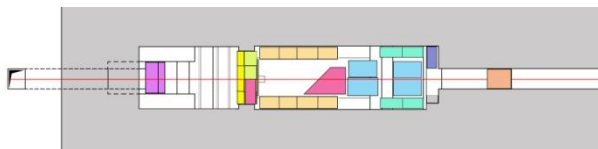

The team in the second room straightened the first bevel-cut slab³⁰⁰ and laid it on the new masonry; it was then pressed against the left rafter³⁰¹.

The team straightened the second bevel-cut slab, laid it on the masonry and pressed it against the right-hand rafter.

³⁰⁰ To follow the slope of the room's roof

³⁰¹ View from inside the second chamber.

STRABO'S PORTCULLIS CHAMBER

I'll explain below the idea of using vertical slabs laid on masonry.



In the second chamber of my theory announced in January 2011, I indicated 2 rows of blocks laid on the Portcullis to reinforce the closing of the entrance to the Noble Circuit.

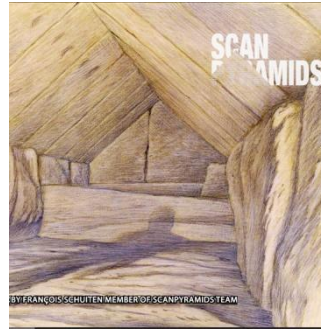

Observing that the bottom of the second chamber is blocked by 2 vertical slabs laid on a bed of limestone blocks similar to those laid on the Portcullis, it seems more than likely to me that the designers had the same idea for solidly blocking the Portcullis. This method is also simpler and quicker than building a wall.

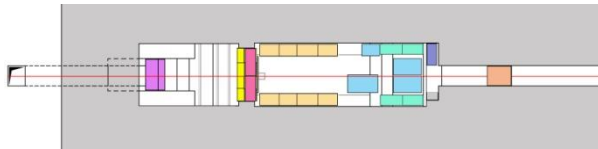

A first block, stored in the center of the chamber, is placed under the East rafters to fill the gap left by the displacement of the counterweight.

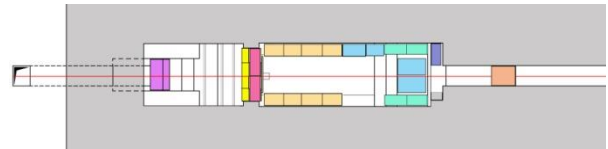

A second block fills the remaining space.

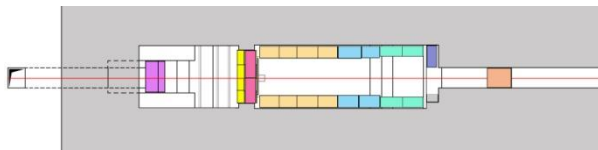

The same operation is carried out with the 2 blocks stored in the center at the rear of the chamber to fill the vacant space under the rafters on the West slope.

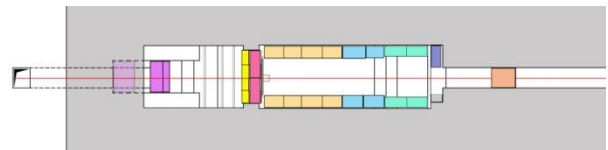

In the first entrance chamber, the last workers on site are lowering the upper slab closing off the passage between the descending corridor and this chamber.

STRABO'S PORTCULLIS CHAMBER

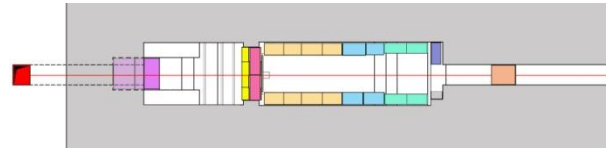
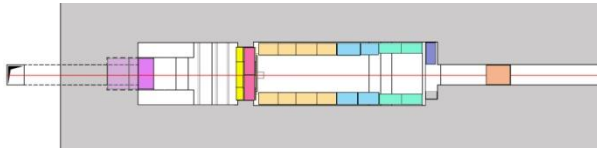

In the first chamber, the workers tilt the lower closing slab, leaving just enough space to slip into the descending corridor. Once in the corridor, they lower the slab once and for all. It becomes impossible to discern the presence of a passageway above them.

After exiting to the outside via the descending corridor, the workers join the last of the funeral officials to seal the entrance to the pyramid. The block, waiting on an inclined wooden support, is presented in front of the opening; after a final ritual, the block is released into its final home, drowned among thousands of similar blocks.

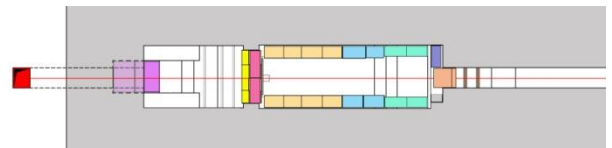
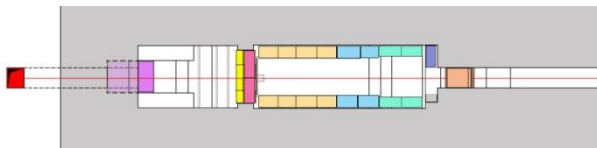

Meanwhile, the team in the second chamber inserted wooden crosspieces into the holes³⁰² in the side walls at the start of the Noble Circuit.

The closing slab is slid into its final position.

The slab is now in contact with the sill on which it will rest. A few workers remained in the second chamber.

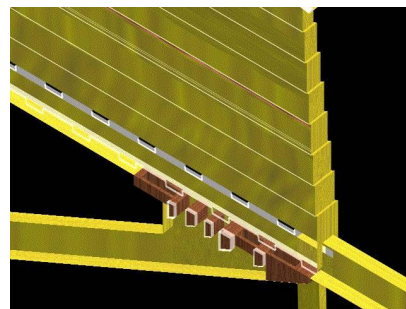
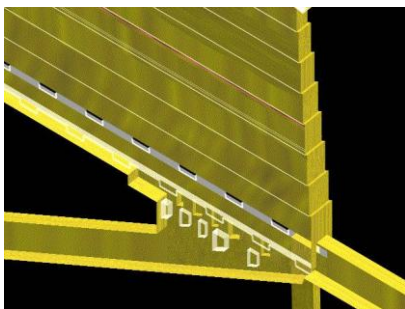

Configuration of the lateral holes dug at the bottom of the Grand Gallery, with wooden crosspieces inserted.

³⁰² The same type as those dug in the lower part of the Grand Gallery, where the ascending and horizontal corridors meet.

STRABO'S PORTCULLIS CHAMBER

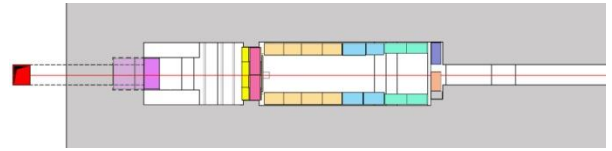
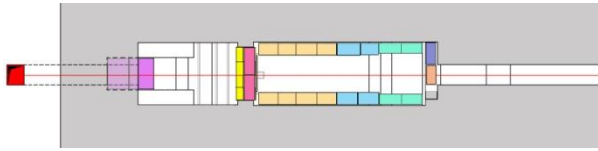

The slab has been positioned vertically; it will now be pushed westwards by around 25 cm by workers stationed on both sides.

The vertical slab was pushed back 25 cm, leaving enough space for the workers in the second chamber to return to the Noble Circuit.

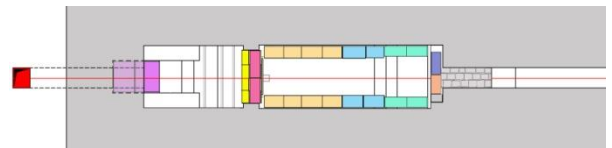
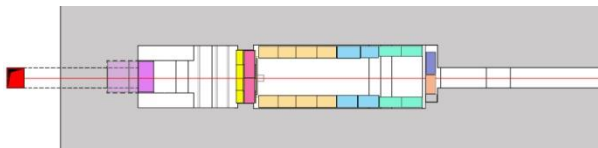

The slab waiting at the rear of the second chamber is pushed westwards with a lever to fill in the 25 cm.

Before leaving the Noble Circuit, the workers backfill the lower part of the remaining space with small limestone blocks sealed with plaster up to the base of the ascending corridor N°2.

After evacuation through the vertical well linking the Circuit Noble to the internal ramp, the remaining space is filled with limestone chips, as in mastabas.

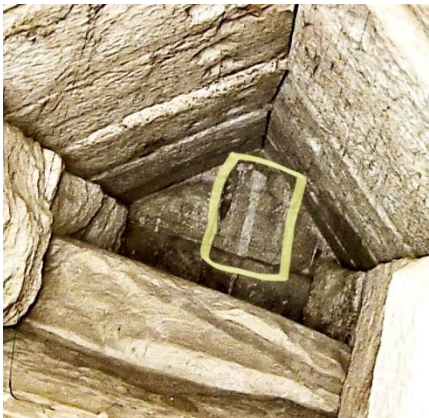

Curiously, traces of what appear to be plaster drips are visible on the West slab at the back of the chamber, one of which is in line with the axis of the chamber, i.e. plumb with the well linking the Circuit Noble to the internal ramp!

STRABO'S PORTCULLIS CHAMBER

Comparison of the reconstruction of two entrance chambers to the Noble Circuit after the funeral with the current condition of the rafters area and the discovered chamber announced on March 2, 2023



Original condition of entrance rooms.



From the cross-section of Gilles Dormion's N°5 plan

Current condition.

Comparison of the reconstruction of two entrance chambers to the Noble Circuit after the funeral with an update, for this Memoir, of the version presented to the public on January 27, 2011.



Same image as above, but with the lower level of the internal ramp positioned in relation to the roof rafters.

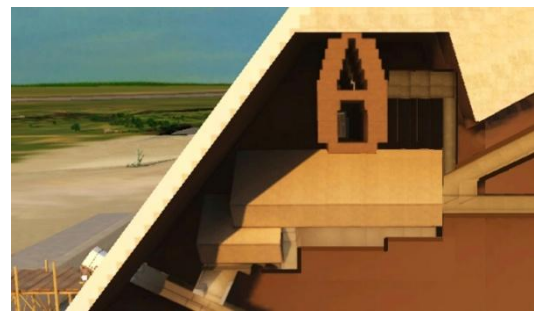

Version updated for this Memoir from the 2011 version of the "Khufu Reborn" presentation.

Comparison of the updated version for this Memoir with the original version presented to the public on January 27, 2011.

The "FUNCTION" hasn't changed, just the "FORM"!



Version updated for this Memoir from the 2011 version of the "Khufu Reborn" presentation.
 Moving the sarcophagus from the first to the second chamber **TRANSVERSALLY** eliminated a good part of the second chamber's volume.
 The lowering of the Portcullis made this solution possible.
 The second chamber is slightly longer, so the internal ramp is centered on it.



"Khufu Reborn" version revealed in 2011.
 Moving the sarcophagus from the first to the second chamber **LONGITUDINALLY** meant that the floor of the second chamber had to be level with the Strabo Stone.
 This had to be stored at the back of the chamber to allow passage for the funeral procession and to be pushed under the rafters. The internal ramp was slightly less well centered on the second chamber.

STRABO'S PORTCULLIS CHAMBER

The last workers sealing the second entrance chamber exit from the inside

In the January 2011 "*Khufu Reborn*" version, the last workers reached the upper level of the second section of the internal ramp via the connecting well running from the ceiling of the Noble Circuit departure point directly behind the second chamber. Once inside the internal ramp, they reached the first section leading to the base of the pyramid and quietly exited. The entrance to the ramp was then sealed off, erasing any trace of its presence.

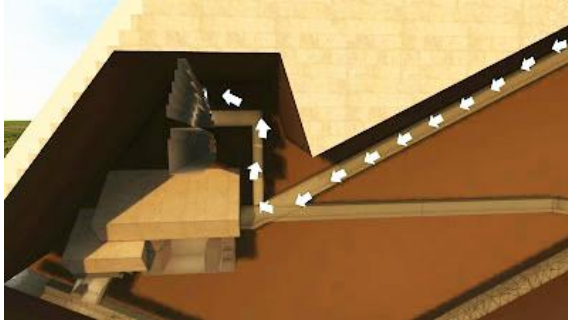

Exit route for the last workers at the end of the funeral and sealing of the Noble Circuit in the January 2011 version of "*Khufu Reborn*". A vertical well links this to the upper level of the internal ramp.

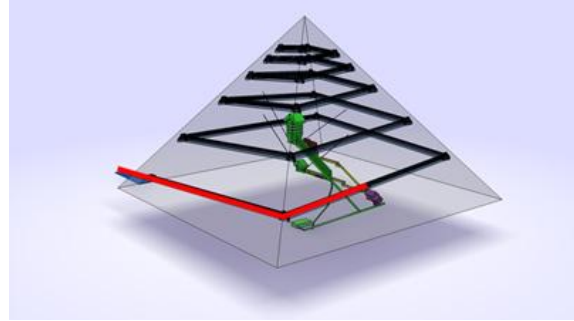

In this 2011 version, once inside the internal ramp, the workers reach the entrance to the internal ramp in the South-East corner of the South face. They have another 265 m or so to cover before reaching the open air.

That said, as time has gone by and my knowledge has advanced, I've revised my thinking about the current condition of this internal ramp due to several factors:

- Facts³⁰³ and clues support the strong probability that the corridors in the pyramids of this period were filled in before they were finally closed.
- The proximity of the faces along the entire length of the internal ramp, with its 7% slope, created a weakness in the structure of the backing stones that would have led the designers to take no chances of a possible collapse of this monument built for Eternity.
- The scant information obtained about the internal ramp by the ScanPyramids mission, which was not designed to detect it³⁰⁴, does not support the view that there is a continuous void. The muography carried out in the area of the North face entrance should have indicated the presence of such a void, but this was not the case. On the other hand, the detection, in November 2015 during the CEA telescope test campaign, of Cavity C1³⁰⁵ under the northeastern edge some twenty meters above Cavity C2 with a confidence index well in excess of 5 sigma, is a very positive result for the internal ramp. What's more, Cavities C1 and C2 are both on the route of the internal ramp. Finally, it should be added that other cavities were detected under other edges, but were unfortunately not investigated further due to the priority transfer of telescopes to complete the data on the BIG VOID; the number of sigma acquired was insufficient to consider them as discoveries.

I came to the conclusion that the internal ramp had been filled in³⁰⁶ between the rooms in the edges³⁰⁷ at the end of the construction work, right down to the base, and that a tiny part had been left empty for the burial and sealing of the pyramid.

On page 56 of this Memoir, I referred to the first announcement made to the press by the ScanPyramids mission on November 9, 2015 concerning the discovery, thanks to infrared, of a significant anomaly at the base of the pyramid's East face. I added that this discovery had been

³⁰³ See footnote 296 on the Bent pyramid at Dahshur.

³⁰⁴ Reason N°1 for my being sidelined from the ScanPyramids mission by the Egyptian Authorities...An "*agnostic*" mission...

³⁰⁵ This subject will be covered in the 3rd Memoir trilogy.

³⁰⁶ More on this also in the 3rd Memoir to come.

³⁰⁷ For the rotation of the sledges in the corners and whose Cavities C1 and C2 are remnants.

STRABO'S PORTCULLIS CHAMBER

"mistreated" in the literal sense of the word, and yet the specialists³⁰⁸ who intervened have strong reasons to believe in the data collected³⁰⁹. I rounded off with this sentence:

"As I'm well acquainted with the architectural and constructive mindset of the designers, Hemiunu and Ankh-haf, I wouldn't be surprised if they'd had an idea about this area of the pyramid that lay within the enclosure of the Upper Temple".

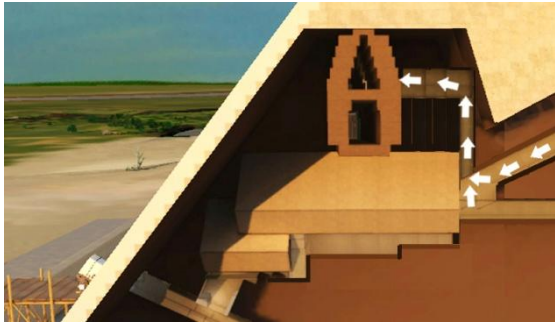

Updated following the discovery of Strabo's Portcullis Chamber. The exit route for the last workers at the end of the funeral and sealing of the Noble Circuit is identical, with a vertical well linking it to the upper level of the internal ramp.

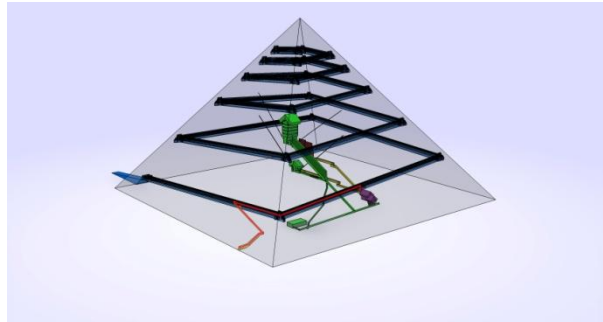

In the new 2023 version, once inside the internal ramp, workers exit more quickly via a downward corridor built to link the Upper Temple to the ramp.

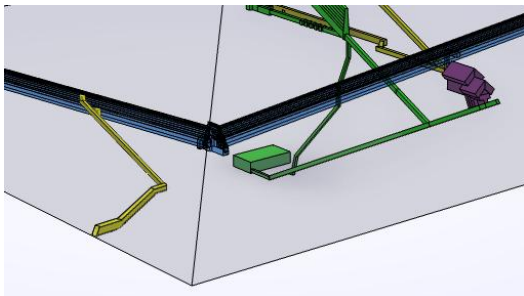

Built from the outset, this corridor was used by dignitaries travelling directly to the construction site.
When the internal ramp was backfilled at the end of the project, less than 100 m of the upper level remained empty, between the vertical well and the exit corridor.

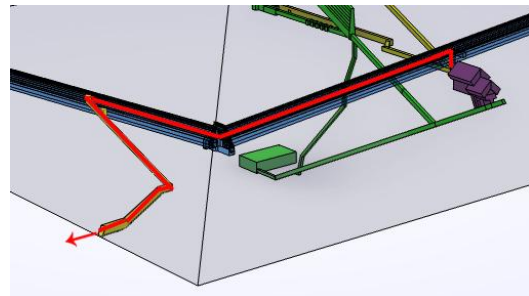

Some twenty meters after entering the 1st section of the internal ramp, the workers take the descending corridor to the Upper Temple.
All that's left is to seal the exit, a minor operation far from the public eye.



On page 57 of this Memoir, I quote Jean-Claude Barré:
"...which lead us to the conclusion that this particular feature is of great interest for further study and could potentially correspond to a subsurface anomaly (a cavity, a corridor, stone restoration, etc.). Alternative non-destructive techniques (muons radiography, radar, etc.) could help to gain more information about its nature".
I think they're even more topical after the discovery of Strabo's Porticullis Chamber.

³⁰⁸ Jean-Claude Barré and Clemente Ibarra-Castadena

³⁰⁹ See page 56, fifth paragraph and page 57, note 206.

STRABO'S PORTCULLIS CHAMBER

13 - BACK TO THE 4 KEY POINTS

In Chapter 4 - THE 4 KEY POINTS³¹⁰, I wrote:

"Much of the History of this pyramid is impossible to write until a rational explanation is provided for each of the following problematic points:

5. *The granite block abandoned in the King's Chamber,*
6. *Closure of the service well at the bottom of the Grand Gallery,*
7. *The three granite plugs at the bottom of the ascending couloir,*
8. *The original entrance to the pyramid".*

I went on to write: *"The stones talk"*.

And now I can say: *"They talked very well"*.

On the basis of the discoveries announced by the ScanPyramids mission, my analysis of the data³¹¹ and the reality³¹², it is now possible to finally provide the only plausible rational answer to each of these problematic points, so indisputable is the evidence.

1 - The granite block abandoned in the King's Chamber.

I concluded on page 22 with these two 3D images and the caption text.

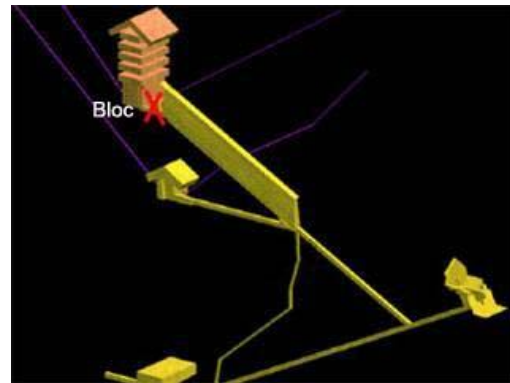
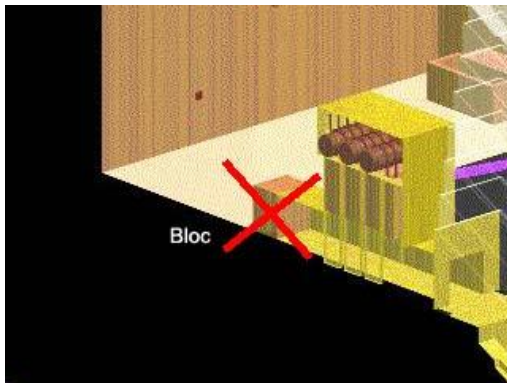

The sealing of the access to the King's Chamber from the Grand Gallery highlights a fact: it cannot be explained rationally, as something is missing to provide a credible solution.

Looking at the pyramid's known interior architecture, and taking into account the problem of installing the block to close the access to the King's Chamber, the first impossibility becomes apparent.

In the first Memoir devoted to the BIG VOID, I wrote:

"Analyzing the architecture of the Portcullis Chamber carefully, it is obvious that it is not optimized for an efficient blocking function because it had another important role during the construction: to be the base of a well in which the motor of the GG2 counterweight system moved. This room was the temporary shed in which the three motor lests were stored when the counterweight was not in use. The well itself was the exact extension of the North, East, South and West walls of the lower part of the chamber and had the same lateral grooves on its East and West walls, ensuring the parallelism of the portcullis-lests during maneuvers".

³¹⁰ See page 20

³¹¹ See the first Memoir The BIG VOID.

³¹² See this Memoir about the SP-NFC, which I now call "Strabo's Porticullis Chamber".

STRABO'S PORTCULLIS CHAMBER

Comparing this Portcullis Chamber with Strabo's Portcullis Chamber, the subject of this Memoir, a first observation is in order:

- the first is nothing more than a "corridor" with details cut into the masonry for a "FUNCTION" far more important than blocking the way to potential looters, its "FORM" not being optimized at all. Leaving a free space of over two meters twenty above the Portcullis in their final position is certainly not the best architecture for this type of function. The fact that this space is filled with masonry does little to change the problem, as anything placed in this way can easily be dismantled³¹³.

- the second is a structure made up of two successive chambers almost fifteen meters long, with a base width of over three meters sixty and a height varying from two meters forty to five meters, all designed to contain a block of Turah limestone weighing around seven tons, trapped in a well of its own dimensions and impossible to move one millimeter. It's quite another thing...

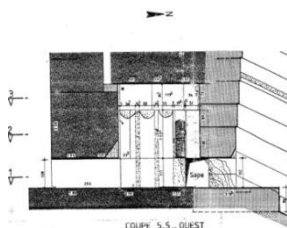

Gilles Dormion Cup



The "so-called" Portcullis Chamber.
A second function for a room that has been used while the BIG VOID was in operation.
(Scaled version to the Strabo's Portcullis Chamber in the image on the right)

A formidable barrier preventing access to the Noble Circuit, which remained inviolate for 45 centuries, even though the first part has disappeared and the second is less than a meter from the outside!

I kept going on the next page with two sketches showing the vertical "well" overhanging this Portcullis chamber during its basic function: to be one of the elements of the "motor"³¹⁴, with its three Portcullis³¹⁵, of the counterweight system moving in the BIG VOID, a second Grand Gallery, linked to the hoisting of the structure's beams above the King's Chamber.

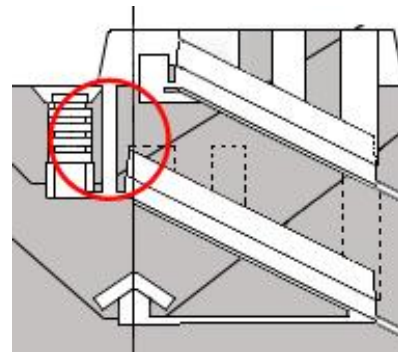
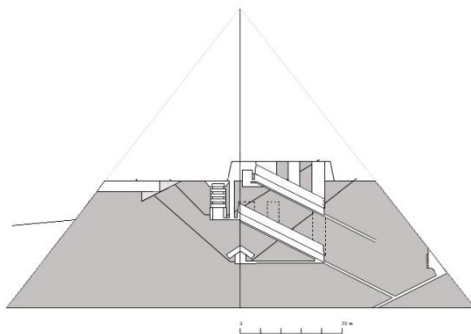

On the left, a new sketch with the well overhanging the Portcullis chamber. On the right, a close-up view of the well in which the three lests-Portcullis moved, forming part of the system's motor.

Looking at the sketch on the right, one will immediately notice that there's an opening available above the Portcullis Chamber until construction of the structure above the King's Chamber is completed.

³¹³ This must surely have been done, and was quickly cleared away by the looters.

³¹⁴ See The BIG VOID, starting on page 31.

³¹⁵ In the role of "lests" rising up and down in the well during use of the counterweight

STRABO'S PORTCULLIS CHAMBER

Finally, I wrote:

"Reading once again my written notes my thinking hours, I saw that as of August 30, 2017 I had written a few lines about an amazing idea regarding the relationship between the well above the Portcullis Chamber and the King's Chamber: the simpler and very likely answer to a riddle I thought I had solved convincingly a decade ago but based on knowledge earned long before the ScanPyramids mission. Again, a consequence of reverse engineering I will discuss in my next document to come".

The note accompanying the word "enigma" referred to the closing of the current entrance to the King's Chamber with the³¹⁶ block left behind in it. In the words of Commissioner Antoine Bourrel: *"Good Lord! But it's of course!"* The missing element for a credible solution³¹⁷ is quite simply that well!

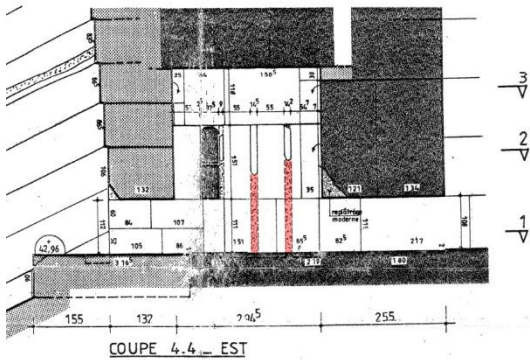

Gilles Dormion Cup

East wall of the Portcullis Chamber.
Two separators (in red) protruding 9 cm between the Portcullis rails were carefully leveled over three-quarters of their height.

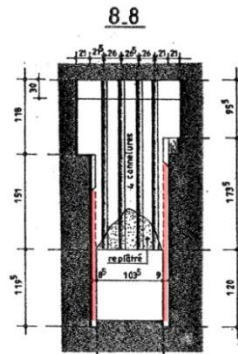

Gilles Dormion Cup

View towards the south wall of the Portcullis Chamber. The separators (in red) between the East wall on the left and the West wall on the right have been carefully leveled.

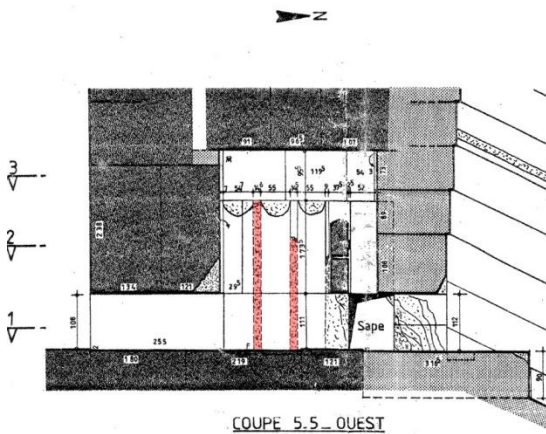

Gilles Dormion Cup

West wall of the Portcullis Chamber.
The two separators (in red) protruding 9 cm between the portcullis slides opposite those on the East wall were also carefully leveled, the one on the left at full height.



West wall of the Portcullis Chamber.
On the left, one of the wall's two separators, which have been carefully leveled.

This meticulous work is clearly not that of thieves in a hurry to force their way in by breaking the separators of the portcullis that would have been inserted between them, especially over a height far greater than that of these portcullis. All the evidence suggests that the entire width of the chamber

³¹⁶ With "Khufu Reborn", workers pushing the block from the King's Chamber and then placing the floor slab at this point. This operation took place at the end of the use of the counterweight in the Grand Gallery.

³¹⁷ See captions below images at the top of page 132

STRABO'S PORTCULLIS CHAMBER

between the fixed portcullis still in place and the South wall needed to be made available up to a certain height.

This brings me back to another sentence on page 21 followed by two sketches also based on Gilles Dormion's plans:

“A close look at the dimensions of the Portcullis Chamber, the passageway leading from the Grand Gallery and the passageway leading to the King's Chamber reveals one thing: the width of the former, 1.03 m, is insufficient (red circle) to allow a granite block (green) to pass through to seal the latter, which is 1.05 m wide³¹⁸. In addition, a 1 cm-high projecting slab (red arrow) blocks the passage under the fixed portcullis, making it impossible to push the block from the Grand Gallery”.

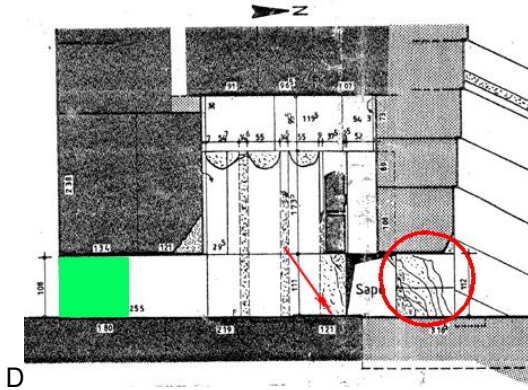

North-South section of the Portcullis Chamber, with the Grand Gallery on the right and the King's Chamber on the left.

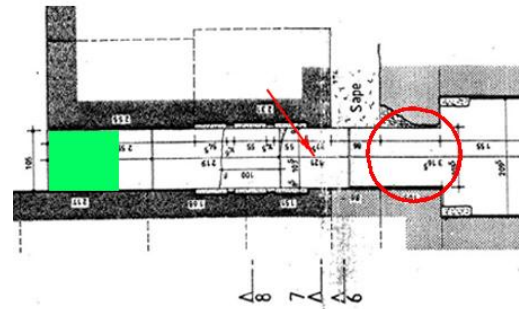

Section and plan by Gilles Dormion

North-South plan of the Portcullis Chamber, with the Grand Gallery on the right and the King's Chamber on the left.

In these sketches, the green square represents the block closing off access to the King's Chamber; the red arrow indicates the 1 cm protrusion slab and the red circle the passage between the Grand Gallery and the Portcullis Chamber. Including the availability of the³¹⁹ well and the leveling of the separators described above, all the elements required to recreate the closing sequences of this room are in place.

In my Memoir The BIG VOID³²⁰, I described the end of monoliths hoisting operations up to level +51.85 m, which marked the end of use of the Grand Gallery³²¹, later replaced by The BIG VOID, the building site's second Grand Gallery³²².

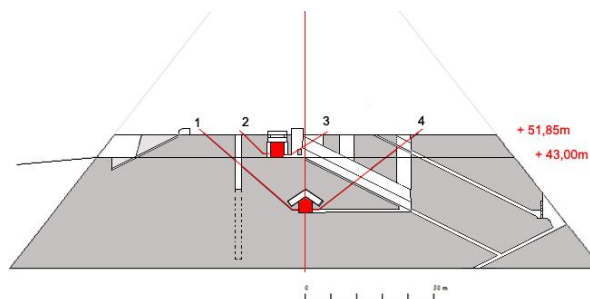

³¹⁸ It's hard to imagine that the Egyptians were content to seal this corridor with a block that was too "small"!

³¹⁹ In fact, two wells, the "motor" well and the well at the top of Grand Gallery GG1.

³²⁰ From page 101 to page 103, subchapter 3 - Phase 2A - Hoisting of the beams and construction of the 2nd ceiling. Last process of Phase 2A.

³²¹ As a reminder, I call it GG1.

³²² Which I call GG2.

STRABO'S PORTCULLIS CHAMBER

As a result, GG1 had no further role to play until the end of the project, and the moving parts of the counterweight system circulating in it were to be dismantled for reuse in GG2, with the exception of the three granite blocks of the base load; these were to be abandoned in situ by being launched down the ascending corridor, ending up as "plugs" at the base of the latter³²³.

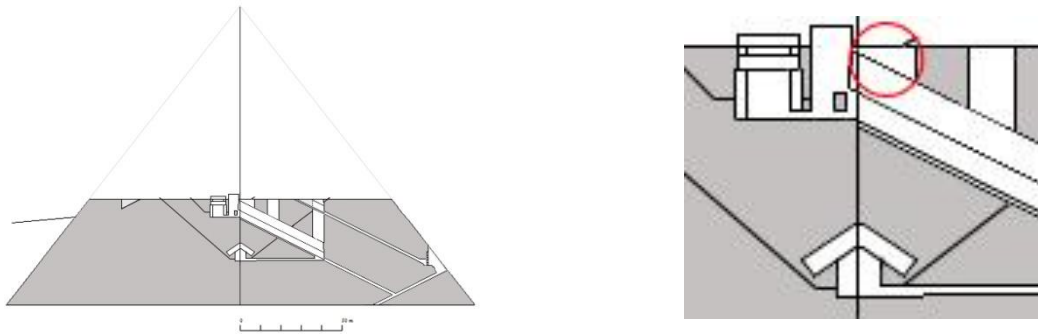

Left, view of the pyramid at the end of counterweight use in GG1. Right, close-up view of the upper well where the counterweight overloads were removed in GG1³²⁴.

At that time, the first operation - lowering the closing block from the Grand Gallery to the Portcullis Chamber - was carried out using the upper well of the GG1, just above its upper platform. Once down, it was stored on one side of the platform, pending completion of the structure above the King's Chamber.

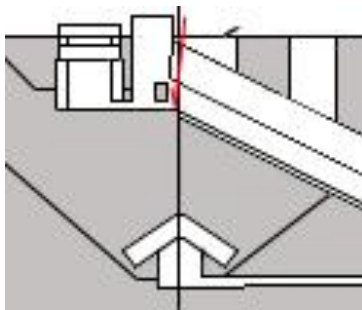

Lowering (red arrow) of the closing block for the passage between GG1 and the Portcullis Chamber.

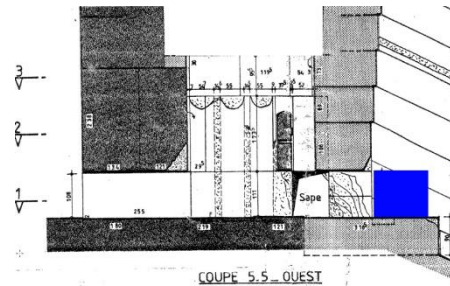

Gilles Dormion Cup

The block (in blue) is stored on one side of the platform at the top of GG1.

Some three years later, with all the rafters hoisted to the level of the King's Chamber roof, the GG2 has fulfilled its mission and the counterweight is dismantled and removed. Now, before the roof is built, the Portcullis Chamber is sealed thanks to the "motor" well that allows the descent of the block that will close the access to the King's Chamber; the leveling of the separators will find its justification here.

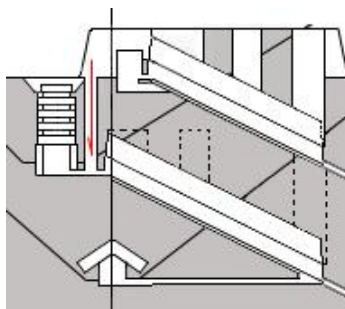

All the other closing blocks for access to the King's Chamber are lowered down through the "motor" well.

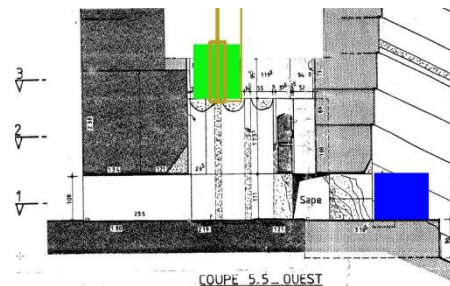

Gilles Dormion Cup

The first block to descend is the one for the access corridor to the King's Chamber. It is suspended from a load-bearing rope.

³²³ This operation is described in the third sub-chapter below.

³²⁴ See The BIG VOID Memoir from page 57 to page 69.

STRABO'S PORTCULLIS CHAMBER

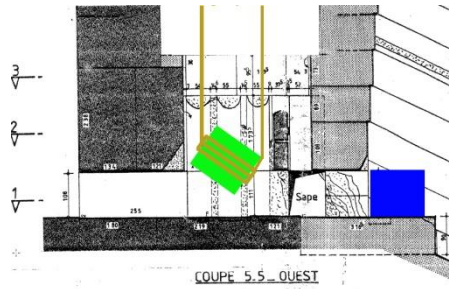

Gilles Dormion Cup

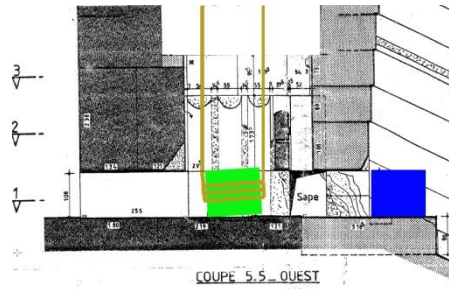

Gilles Dormion Cup

Once inside the Portcullis Chamber, the block begins to rotate next to the leveled separators. This operation was necessary to allow the ropes girdling laterally the block to pass between the East and West walls. A second rope is used to raise the base of the block.

The block has now arrived at its destination, resting on the King's Chamber side on the paving at access corridor level, and on the GG1 side on the 1 cm protrusion slab.

Why this particularity?

Quite simply, to eliminate the "start-up friction" when pushing the block, which increases the force required.

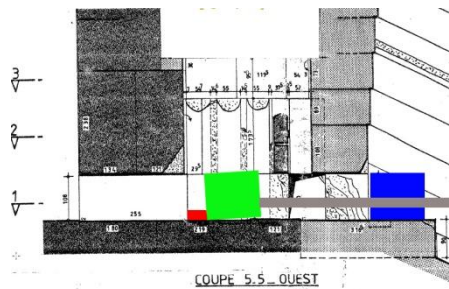

Gilles Dormion Cup

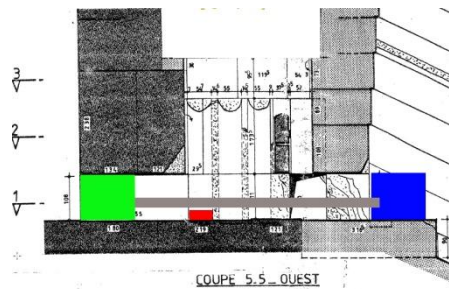

Gilles Dormion Cup

2 pieces of wood (in red) are inserted into the side holes in the paving to guide the block into the access passage. A fine sprinkling of sand is applied to the access passage paving to help the block slide.

The block was pushed from GG1 using a piece of wood as a piston. The block was stopped by the 2 cm step in the paving of the King's Chamber. The length of "level" paving between the protusion and the entrance to the access corridor is sufficient for the block to penetrate horizontally.

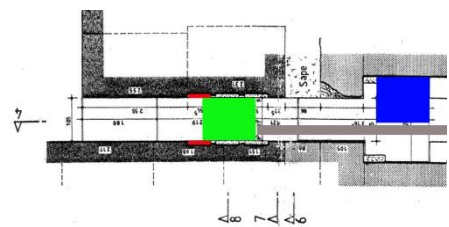

Map of Gilles Dormion

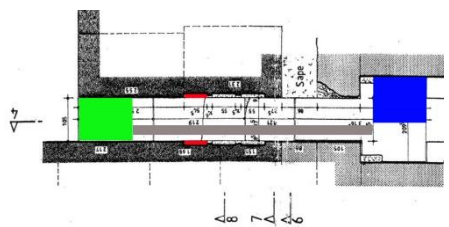

Map of Gilles Dormion

2 pieces of wood (in red) are inserted into the side holes in the paving to guide the block entry into the access corridor. The thrust piston (in brown) is in place, operated from the GG1.

The block was pushed and came up against the paving of the King's Chamber.

Then it was the turn of the granite weights that served as the³²⁵ "motor", which have completed their first function and begun their second, becoming blocking portcullis.

³²⁵ See The BIG VOID from page 31.

STRABO'S PORTCULLIS CHAMBER

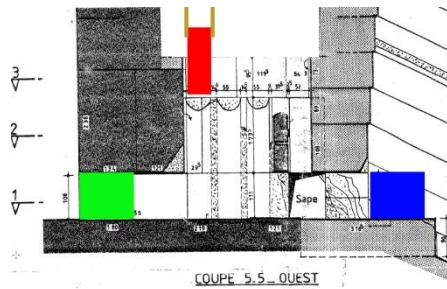

Gilles Dormion Cup

The 1st portcullis is lowered to its future location against the access corridor to the King's Chamber.

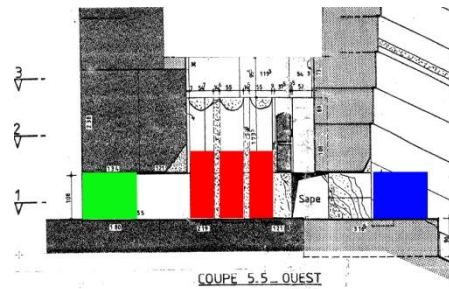

Gilles Dormion Cup

The other two portcullis are back in place. They can then be "locked" at³²⁶ by temporarily raising the double portcullis, which is still present.

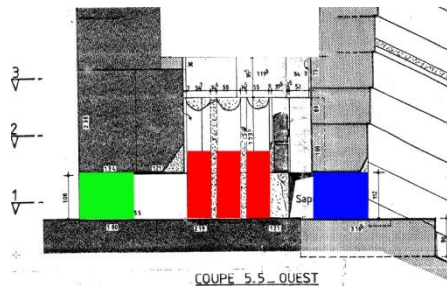

Gilles Dormion Cup

The block stored in GG1 (in blue) is placed in the passage between the latter and the Portcullis Chamber.

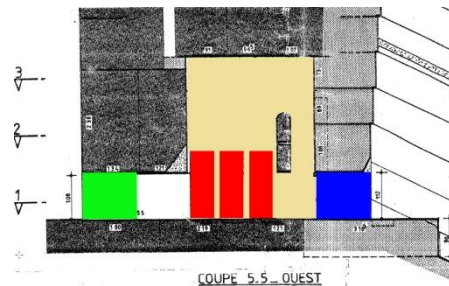

Gilles Dormion Cup

The "motor" well is filled with limestone chips up to the level of the ceiling before it is laid. The ceiling is made up of 3 granite slabs, which are lowered through the well, which is also filled in the same way once the ceiling is complete.

Conclusion:

Nothing could be simpler to give certain efficiency to a form that is not optimized for a second function, when the designers have foreseen this solution in the project from the outset.

To borrow a phrase from Albert Einstein that I've already used in my memoir *The BIG VOID*³²⁷ :

"A problem without a solution is a problem badly posed".

In the case of the Portcullis Chamber, the problem is poorly posed simply because the available data is totally incomplete. Once architectural analysis, clues and evidence of the existence of other volumes³²⁸ and corridors have entered the equation to be solved, a simple and logical solution becomes obvious, the evidence supporting it being there, namely :

- the impossibility of bringing in the block sealing the King's Chamber from the Grand Gallery,
- leveling of separators,
- the 1 cm protrusion of the paving at the precise point of use,
- the 2 cm protrusion in the paving of the King's Chamber floor.

And the list goes on...

It's not hard to understand why no one has ever been able to come up with a satisfactory solution by thinking about the problem only with the data that was available:

There are none!

³²⁶ As proposed by Gilles Dormion in his book "La Chambre de Khéops", Analyse architecturale - Éditions Fayard, pages 196 and 197.

³²⁷ Page 7, under Chapter 3.

³²⁸ Strabo's Portcullis Chamber in particular.

STRABO'S PORTCULLIS CHAMBER

2 - Closure of the service well at the bottom of the Grand Gallery.

In the second paragraph on page 25 I wrote:

"The conclusion is clear: the service well was never designed and built to allow workmen to leave the Grand Gallery and reach the outside via the descending corridor".

Followed by these two 3D images and the caption text.

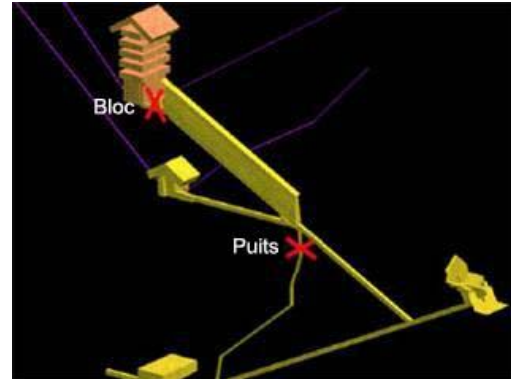
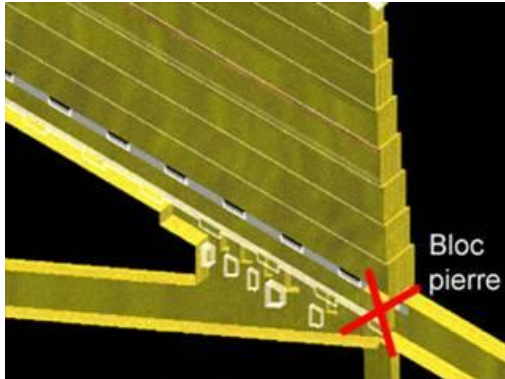

Following the closure of the Subterranean Chamber and the need to maintain adequate ventilation, the service well at the bottom of the West bench of the Grand Gallery was meticulously sealed to allow the counterweight system to be installed. The closing process had not been designed to allow temporary reopening. No exit from the Grand Gallery was now possible via the service well.

There's nothing to change in the caption below the two 3D images.

In addition to my explanations as to why it was impossible for the workers to "escape" from the Grand Gallery after a funeral procession, which would have taken the current "official" route³²⁹, the discovery of the second entrance chamber behind the entrance rafters provides absolute proof that it was in contact with the outside via the descending corridor. More importantly, it's hard to argue with the fact that this chamber provided access to all the volumes built into the pyramid, both known and yet-to-be-discovered, but whose existence is either proven, such as the BIG VOID, or suspected, such as the internal ramp. The presence of the latter is highly probable, firstly on the basis of architectural analysis of the entire construction, and secondly on the basis of an abundance of precise clues, not least the discovery of Cavity C1, above Cavity C2.

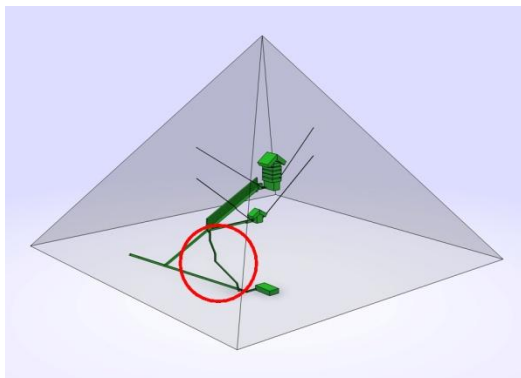

The service well, a narrow passageway through more than fifty-five meters of masonry and rock.



The evacuation well used by the last workers to seal the pyramid from the inside: just a few meters away to reach the inside ramp and leave the monument with ease.

³²⁹ Descending corridor, ascending corridor, Grand Gallery, Portcullis Chamber and last corridor to the King's Chamber.

STRABO'S PORTCULLIS CHAMBER

This leads to a simple and logical conclusion regarding the evacuation of the last workers: why would the designers have given this role to the³³⁰ service well linking the bottom of the Grand Gallery to the bottom of the descending corridor, a distance of over fifty-five meters to cover in very difficult conditions, when a vertical well about five meters high, starting from the back of the second entrance chamber and linking the internal ramp, was available!

3 - The three granite plugs at the bottom of the ascending couloir.

Information note N°5 :

One day in December 2011, I was contacted by a teacher³³¹ who told me that he was looking to introduce his young CM2 pupils to the splendors of the pyramids of Egypt, a subject that fascinated his whole class, writing to me among other things:

"So, with my 28 "budding researchers", every year we get passionate about Khufu, about your work, about the search for the simple truth.

And again this year, we'll be building a cutaway model, drawing plans to scale, comparing theories and feeding our class blog.

It's fabulous! Fascinating my students gives my job meaning! And you contribute to it, without even knowing it."

We thus entered into an epistolary relationship, which continues to this day, made up of questions and answers on the subject of the pyramids, including the exchange I relate below:

"Why is the lower part of the ascending corridor 'cut' into the masonry while the rest is masonry?"

Below is my answer, which is entirely appropriate for this "scientific" memoir:

"The Egyptians did this for three reasons: to avoid making a complex overlap in the ceiling of the descending corridor, to slow down the sliding of the granite plug blocks at the end of their travel and to end up blocking them just before the descending corridor.

They modeled³³² everything 50m east of the pyramid (the "trial passage") and they did well!

What interested them in the ascending corridor was a length of some thirty meters, part of which had to be well constructed for a smooth run of the rollers-train's tension ballast.

The section between the bottom of this well-built part and the descending corridor may not be perfect.

The Egyptians therefore lined up rows of well-calibrated, tightly packed stone blocks from the ceiling of the descending corridor upwards for half a dozen meters, thus reconstituting an artificial bedrock.

Using the grid, axes and plans, they started building the ascending corridor from a precise point, to make sure they got where they were willing to go.

When the masonry corridor was well advanced, "sappers" came in to drill from the bottom of the masonry corridor to "recover" the descending corridor. On the way, they left the walls rough, and better still, drilled in and narrowed the funnel-shaped corridor by playing on the side walls (very slight but real). They recovered the descending corridor without having to make a header. The granite blocks had been cut to the cross-section of the corridor (the first being slightly smaller than the other 2).

³³⁰ Mainly for ventilation of the Chamber opening

³³¹ Cédric Martin, teacher in Rennes's Priority Education Zone.

³³² I've attached a 3D model of this layout with a description of the elements reproduced.

STRABO'S PORTCULLIS CHAMBER

On launch, the 1st block arrived just above the descending corridor, trapped by the narrowness of the corridor, which could not widen given the lateral pressures (all the masonry at this level).

The 2nd, slightly larger block stopped 10cm from the first, thus avoiding the water hammer...

The 3rd block, identical to the 2nd, crashed into the 2nd to push it in. The 3rd block ended up being broken in 2...the al-Ma'mun' breakthrough proves it.

Not stupid, guys... "



Pupils in the CM2 class of the 2011-2012 school year.

I can assure you that these ten-year-old pupils had a wonderful school adventure³³³ that they will remember for a long time to come.

In addition to this note, I am once again attaching below the 3D modeling of this model with the description of the elements reproduced; this document allows a better understanding of the stakes involved in launching the base loads of the counterweight carriage, which will end up as blocks plugs at the bottom of the ascending corridor.

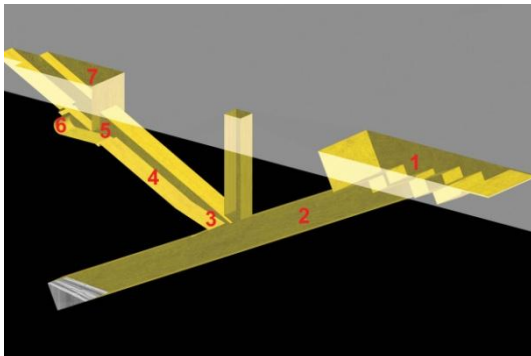

- 1 - Entrance to descending corridor.
- 2 - Descending corridor.
- 3 - Bottom of the ascending corridor.
- 4 - Ascending corridor.
- 5 - Junction of ascending corridor, horizontal corridor and Grand Gallery.
- 6 - Horizontal corridor.
- 7 - Grand Gallery.

In the model, the designers had planned to "raise" the floor of the ascending corridor in the last few meters before the descending corridor, thinking that this would be enough to stop the plug blocks. On analyzing their project, they realized that this solution was very fragile, with the first block ending its slide by "bursting" this area. In the pyramid, they changed their mind by "tightening" the side walls to take advantage of the full pressure of the mass.

Additional note:

On the same model, they dug a vertical well at the beginning of the ascending corridor, an arrangement that does not exist in the pyramid as we know it. This study was intended for another part of the pyramid: the evacuation well for the last workers at the end of the sealing of Strabo's Chamber of the Portcullis, a short well leading from the Noble Circuit to the internal ramp.

³³³ And I'm proud of it.

STRABO'S PORTCULLIS CHAMBER

A second challenge also had to be met when launching the³³⁴ plug blocks: successfully introducing them into the ascending corridor in an area of the Grand Gallery with a large void linked to the junction of three passages, points 4, 5, 6 and 7 in the model above.

On page 26, I already gave an answer:

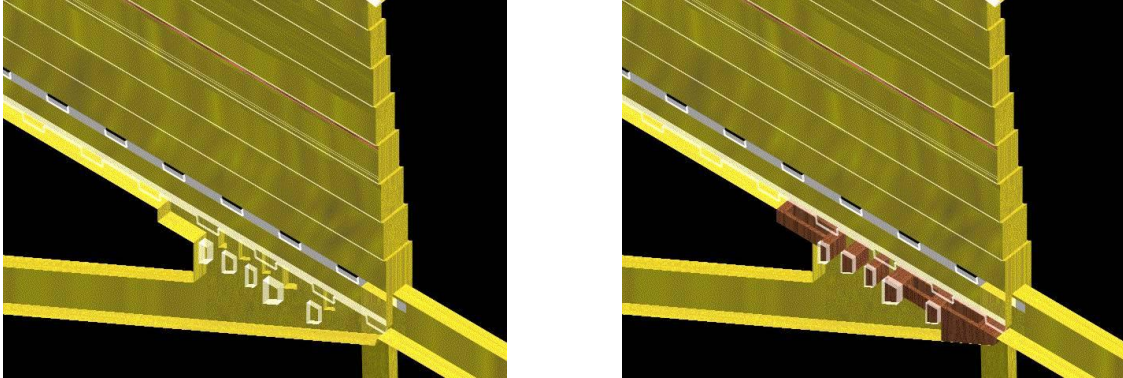

The openings visible in the side walls of this part of the Grand Gallery are undoubtedly linked to the process, based on wooden crosspieces, used to launch the plug blocks.

Launching block plugs in the ascending corridor (C.A.)

Note: This demonstration dates back to mid-March 2005, and since then the counterweight carriage has been improved with the introduction of the "roller train" in the counterweight system. That said, the principle of plug block launching has not changed.

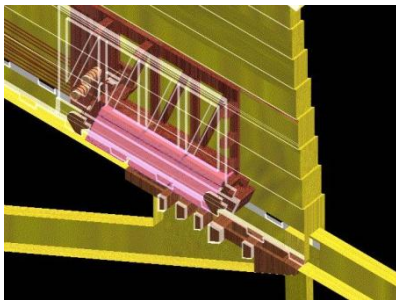

The carriage is brought close to the C.A.

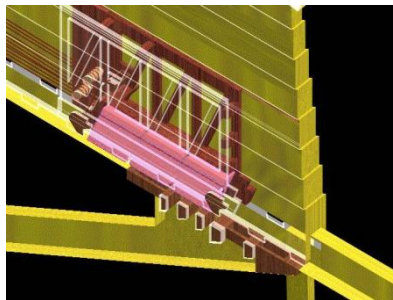

The rear of the carriage is removed.

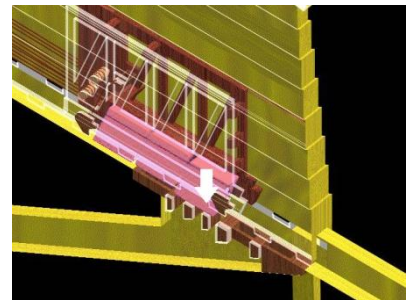

The 1st block is placed on the crosspieces.

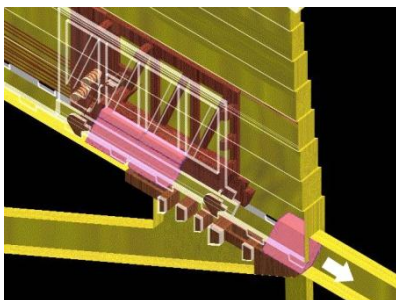

The 1st block is launched in the C.A.

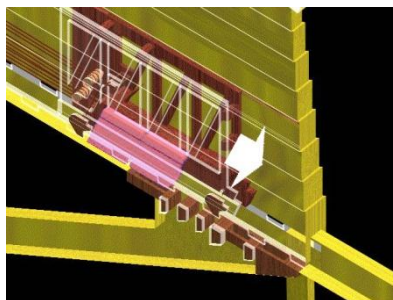

The carriage will be lowered by 1.5 m.

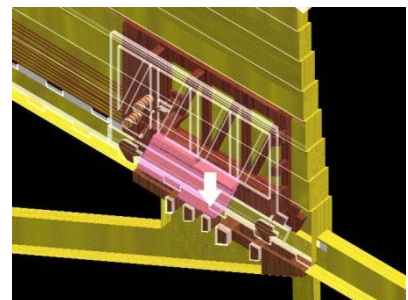

The carriage is on the edge of the A.C., then the 2nd block is placed on the crosspieces.

³³⁴ These granite blocks were suspended by ropes from the center of the carriage structure.

STRABO'S PORTCULLIS CHAMBER

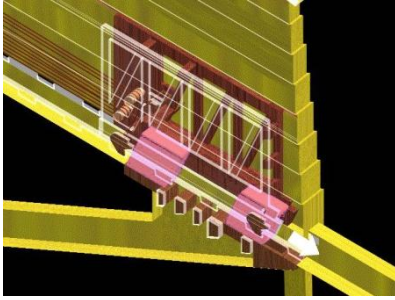

The 2nd block is launched in the C.A.

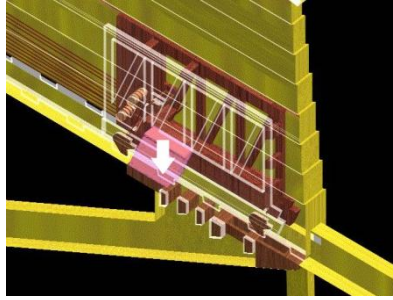

The 3rd block is placed on the crosspiece.

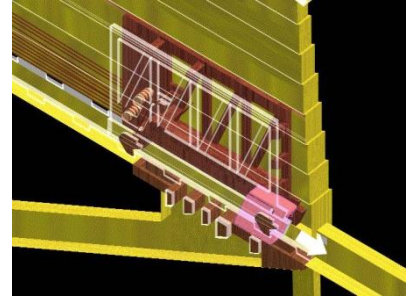

The 3rd block is launched in the C.A.

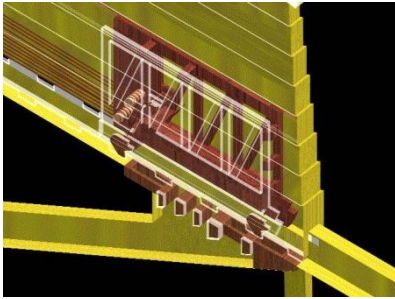

All blocks have been launched in the C.A.

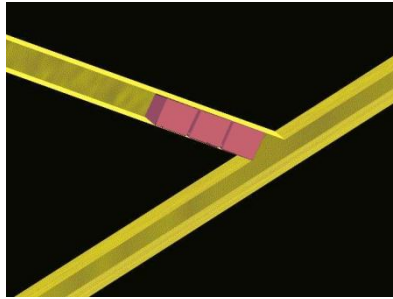

The 3 plug blocks seal the access to the C.A. from the descending corridor.

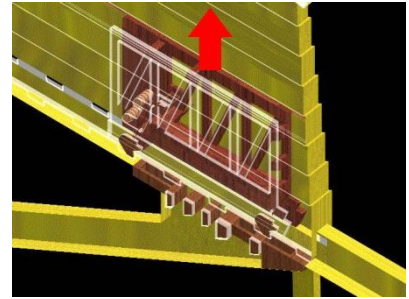

All the ropes have been removed and the carriage will now be dismantled and evacuated from the Grand Gallery via the lower well.

Once extracted from the Grand Gallery GG1, the dismantled carriage was stored on site before being reassembled to be put back into service³³⁵ as a new counterweight in the BIG VOID, the second Grand Gallery GG2. In the meantime, new base loads, identical to those abandoned at the bottom of the ascending corridor, had been cut and transported from the Aswan quarries to reconstitute the carriage's fixed load.

Another example illustrating what I wrote in The BIG VOID on page 9:

"But by defining a whole system based on the principle of counterweight which would be implemented relying on logic, Art of measure, programming and planning of tasks, time management, logistics, operations in sequences, economy of means, division of forces at stake, efficiency, minimal use of human force and finally the repetition of simple tasks".

4 - The original entrance to the pyramid.

In the fourth paragraph on page 29, I wrote:

"It's obvious that the descending corridor led to the outside and that a block of Turah limestone was inserted to seal the pyramid definitively³³⁶ after Khufu's funeral, and that its size didn't distinguish it from the other blocks on the façade. So I can't imagine that the placement of an ordinary block would have been such a momentous event as to cross twenty-five centuries and eventually reach the ears of Strabo, who gave it historical resonance. This block had to be very special to have remained in the memories of the men who passed on its existence for so long".

³³⁵ See *Information Note N°3* page 40 of the The BIG VOID Memoir concerning the dismantling and storage of boats at Wadi al-Jarf, the subject of Pierre Tallet's work. A proven common practice of the time.

³³⁶ Like all the pyramids cited in note 123 above

STRABO'S PORTCULLIS CHAMBER

On page 28, in the caption to the sketch on the right concerning Sir Flinders Petrie's interpretation of the stone mentioned by Strabo closing the access to the tomb in Khufu's Pyramid, I concluded:

"Clearly, this proposal is unrealistic, as it does not clear the passageway".

Petrie's stone is nothing more than a figment of the imagination with no scientific value, yet it has influenced many Egyptologists; I personally find it hard to understand why!

On the other hand, after all I've just written about the heavy stone inserted under the lower rafters with its notches dug³³⁷ into the upper part, I'm not surprised that it made its mark during the pyramid's construction and at funerals.

I would add: *"To the point of reaching the ears of Strabo more than 2,500 years later".*

It wasn't the final sealing stone on the facade that was able to leave its mark, a commonplace stone like thousands of others on the 84,000 m² of facing stones.



The exterior wooden scaffolding providing access to the pyramid's unique entrance. The Turah limestone block sealing the descending corridor was installed on an inclined portico on rollers before the funeral.



The funeral is over, and the Priests recite the last funeral formulas before the workers push the closing block in front of the opening of the downward corridor.



The final moments before the sealing of the entrance to Khufu's Pyramid. The workers pushed the closing block in front of the opening of the descending corridor. They're going to free it to slide it inside and seal Khufu's Pyramid, the "Great Pyramid".



It ends in the middle of 84,000 m² of facing blocks. A final safety feature: it is not aligned with the pyramid's North-South axis, as in all pyramids, but offset by around 6.81m to the East. This detail will cost Caliph al-Ma'mun a fortune: eight months of drilling for a meager profit.

³³⁷ Strabo's real Stone.

STRABO'S PORTCULLIS CHAMBER

Ironically, the "Mystery" of Khufu's Pyramid was born of a forced entrance in 832³³⁸ of our era!

When designing the pyramid, Hemiunu and Ankh-haf must have thought that, with the axis of the unique entrance offset thirteen cubits³³⁹ to the East from the North-South axis, the departure point of the Noble Circuit would be beyond the reach of grave robbers of limited means. They had not imagined that one day a wealthy and determined foreign Caliph, al-Ma'mun, Bagdag Caliph, would order his sappers to dig a passageway starting at the sixth course in the monument's North-South axis, on which, according to tradition, the pyramids' descending corridors were located. The Caliph was convinced that by drilling low enough along this axis, he would inevitably come across the passage leading to the tomb. Unfortunately for the two architects, after some thirty meters of stubborn, more or less rectilinear drilling, the resonance of pick blows on the stone blocks in the corridors leading down and up prompted the sappers to divert their advance eastwards, ending up on the ascending corridor at the level of the plug blocks. The die was cast, and History was about to be written on an unforeseen event.

The exploration of the interior began from this point, with the looters succeeding in breaking into the King's Chamber; after discovering the service well, they left the premises via the descending corridor, at the end of which they uncovered the common entrance to the Service Circuit and the Noble Circuit, but without discovering the latter.

The former, a complete circuit starting from the North face and leading to three chambers and a Grand Gallery, became, over time, the "official circuit" of Khufu's Pyramid. The failure of the Caliph's adventure in his quest for a "Royal Treasure" opened the door to all manner of speculation, giving rise to the "Mystery of the Pyramid", an idea that would apply to everything regarding the monument: secret chambers, treasure, the monument's purpose etc... and, above all of course, to the subject of its construction. In this field, the indigence of proposals made since the dawn of time is impressive!

At the bottom of page 8 of this Memoir, I reprinted a passage of dialogue from the documentary "The Mystery of the Pyramids"³⁴⁰, the source of my research; I reproduce it below:

Audran Labrousse: "Even if we find a perfect theory, there's nothing to say that it's the same one that would have been used; it remains speculation, that's all. You can't believe in a theory until there's absolute proof: it could be a bas-relief, a text, an unfinished pyramid, something. We can only hope for chance: it could be tomorrow, or maybe never. Construction is always a mystery".

Egyptian Egyptologist: "There's no mystery; we're ignorant, we lack the information to solve problems".

Audran Labrousse: "It could be the chance of a lucky discovery".

The discovery of the SP-NFC, or rather Strabo's Portcullis Chamber, by the ScanPyramids mission has opened the door to the Noble Circuit, and will revolutionize our knowledge of Khufu's Pyramid. Its construction was an "enigma" rather than a mystery, an enigma that is about to be solved scientifically as all the pieces of the puzzle are now available. What was missing from Audran Labrousse's words was that, one day, someone with a vision and architectural skills would set about solving this enigma with passion, perseverance and patience - something the Egyptian Egyptologist understood.

On March 2, 2023, absolute proof was announced to the public, and not by chance...but after twenty-five years of research. And there's more to come.

³³⁸ In 820 or 832 AD depending on source.

³³⁹ Or 6,81 m.

³⁴⁰ See footnote 8 page 8.

STRABO'S PORTCULLIS CHAMBER

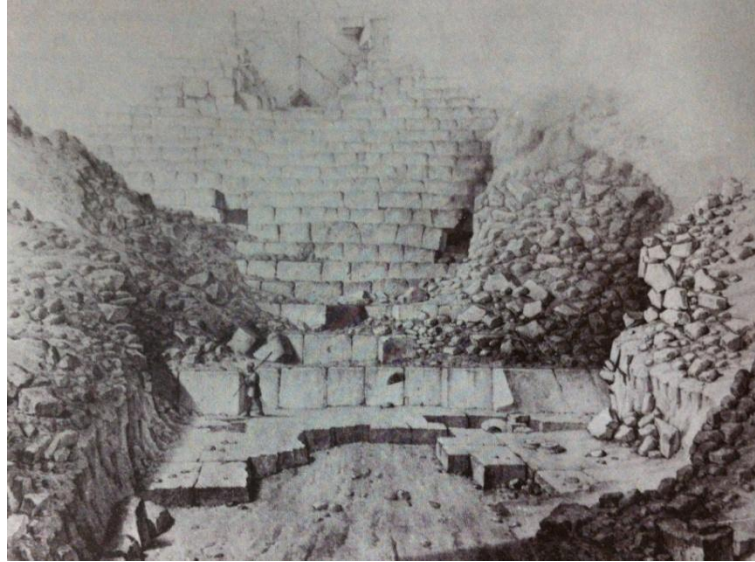

Very old engraving showing the condition of the base of the North face of Khufu's Pyramid. The entrance pierced in 832 AD by the Caliph al-Ma'mun must certainly have disappeared for centuries under the debris resulting from the plundering of the Turah limestone façade blocks by quarrymen delivering materials to Cairo's building sites in the Middle Ages. It was undoubtedly these quarrymen who cleared the masonry, including the rafter roof of the first entrance chamber, above the descending corridor and exposed the two pairs of rafters above the Strabo Stone. The latter was less than a meter away!



Late 19th century photo. The entrance to Caliph al-Ma'mun, on the right, is clear, but there is still some debris at the base of the North face. The man in the foreground gives the scale.

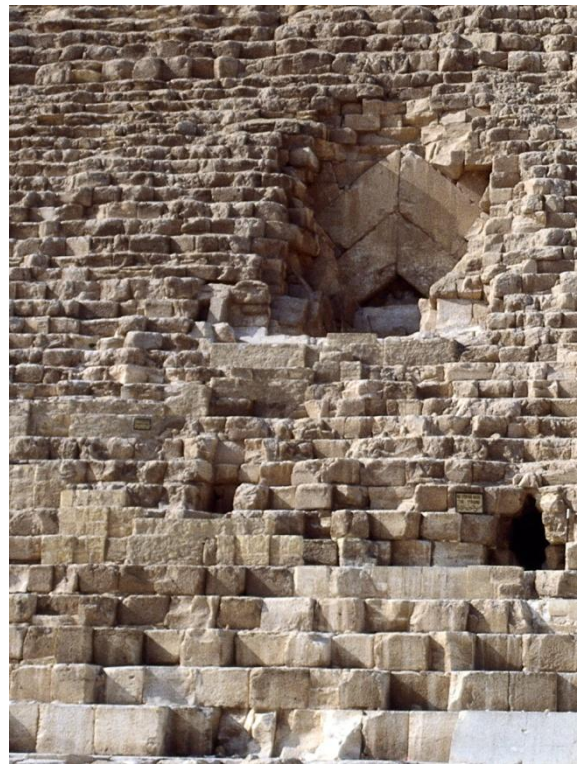

Photo taken in the mid-2000s. The pyramid has long since been cleared of debris. It wasn't until the spring of 2023 that we finally knew what lay behind the entrance rafters: a chamber I had imagined twenty years ago and announced in 2011.

14 - CONSEQUENCES OF THE DISCOVERY OF THE SP-NFC

The first, and by no means least, is the obvious relationship between the BIG VOID and the SP-NFC, both volumes being the result of architectural thinking by the designers of the Great Pyramid.

In the first Memoir of the trilogy, the BIG VOID, after a lengthy architectural analysis³⁴¹, I detailed the many reasons that led me to conclude³⁴² that this great Cavity was none other than a second Grand Gallery built for construction purposes. Like the known Grand Gallery, it had been part of an elaborate counterweight system that had hoisted all the monoliths of the superstructure above the King's Chamber from the bottom of the external ramp to its final roof³⁴³.

Among the elements contributing to traction operations, the well-known³⁴⁴ ascending corridor housed a mobile³⁴⁵ ballast roller maintaining tension on the roller train on which the counterweight carriage moved; the second Grand Gallery being a slightly shorter replica of the first, a second ascending corridor had been built for the same reason, also housing a tension roller. The architecture of this second set, parallel to the first, had led me to extend the second ascending corridor downwards, and what had to happen did happen: this corridor arrived exactly at the beginning of the Noble Circuit, at the rear of the second entrance chamber behind the rafters on the North face.

I had suspected this purpose as early as November 20, 2016³⁴⁶ and was convinced the day the ScanPyramids mission published its *ScanPyramids 2017 Video Report* on Vimeo just after the November 2, 2017 publication of the BIG VOID discovery article in *NATURE* magazine.

Of the three possibilities mentioned, two³⁴⁷ made no architectural sense taken on their own; however, the third, a sloping BIG VOID jumped out at³⁴⁸ the eyes and an imaginary extension of the "cat's tail" towards the SP-NFC discovered in October 2016 was obvious!



As soon as I watched the video published by ScanPyramids, I "saw" in my brain the white line added to the image above. As an architect, it was obvious to me!

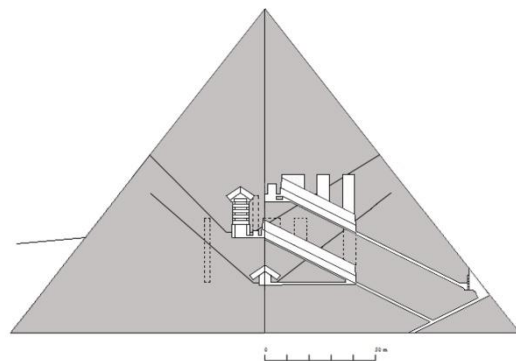

After several years of analysis of the BIG VOID, I was convinced that it was connected to the SP-NFC by an ascending corridor running from the rear of the latter, an extension of the one I imagined over twenty years ago for the Circuit Noble.

³⁴¹ See Le BIG VOID, Chapter 8, pages 48 to 69.

³⁴² See Le BIG VOID, Chapter 9, pages 82 to 99.

³⁴³ See Le BIG VOID, Chapter 10, pages 100 to 109.

³⁴⁴ What I've dubbed "the cat's tail". See Memoir The BIG VOID, Chapter 4, page 13.

³⁴⁵ See Le BIG VOID, Chapter 4, pages 12 and 13.

³⁴⁶ See Le BIG VOID, Chapter 5, pages 20-21.

³⁴⁷ A horizontal or multi-volume BIG VOID.

³⁴⁸ By its parallelism with the Grand Gallery.

STRABO'S PORTCULLIS CHAMBER

Even before the official discovery of SP-NFC was announced on March 2, 2023, I had carried out several studies on the subject, all of which confirmed this obvious fact.

Note: the images of the cross-section of the pyramid that follow have been "horizontally flipped" to match the vast majority of those in this Memoir.

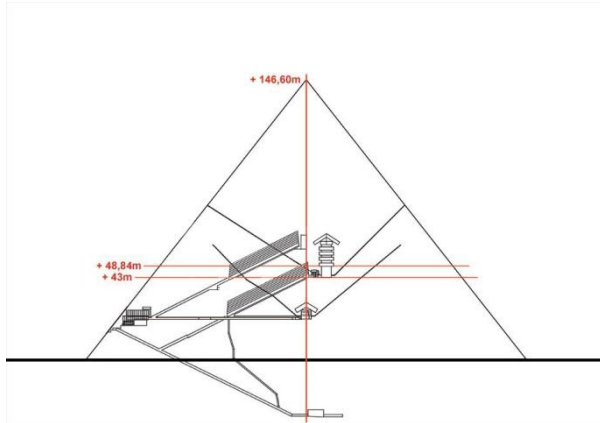

The main part of the BIG VOID, the second Grand Gallery 2017, applied to part of the Circuit Noble version 2011.

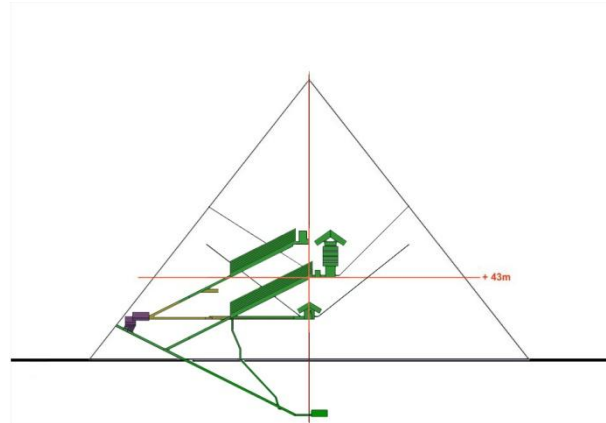

Another version of the main part of the BIG VOID applied to part of the Circuit Noble 2011 version, but with the Chamber of Strabo's portcullis included.

In the Memoir The BIG VOID, Chapter 8, I wrote at the bottom of page 50:

"The latest version of the GG2 and its position above the GG1 now takes into account an important element that was foreseeable: the extension of the ascending corridor in the lower part of the GG2 connects perfectly with the SP-NFC corridor discovered behind the entrance rafters. Again, this is not by chance, but the result of a precise plan. Finally, the entire GG2 set extends from the East-West axis to the plumb of the North wall of the GG1".

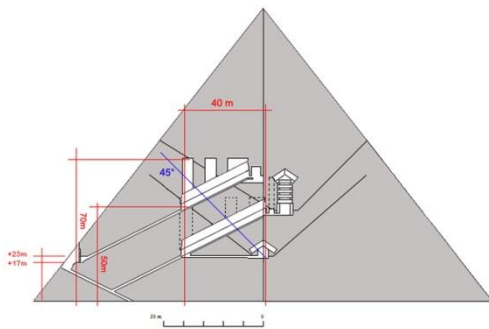

Cross-section of the pyramid including the latest version of the BIG VOID following delivery of the "2019 Scientific Report - September 2019" document to the Egyptian authorities³⁴⁹.

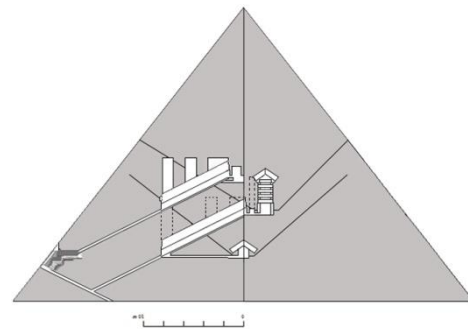

Cross-section with Strabo's Portcullis Chamber in place of the current condition of the entrance on the North face of the sketch on the left.

The discovery of the SP-NFC has brought a major piece of information that is of the utmost importance for the most exact possible positioning of the BIG VOID: an extra point in space! The announced length of the corridor-chamber and the deep position of its back wall not only fit in perfectly with the architecture of the Noble Circuit, but also with the architecture of a second Grand Gallery parallel to the first, the interest of which was detailed at length in the first Memoir³⁵⁰.

³⁴⁹ See Memoir The BIG VOID, Chapter 8, page 51 (here, image also horizontally flipped).

³⁵⁰ The counterweight system at the heart of the King's Chamber and its superstructure.

STRABO'S PORTCULLIS CHAMBER

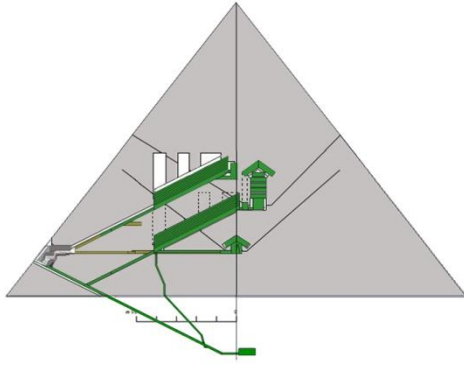

Superimposition of the right-hand sketch at the top of the previous page on the right-hand sketch at the bottom of the same page. The accuracy, following architectural analysis, is astonishing, reducing the vertical margin of error announced by ScanPyramids from a few meters to around 1 m.

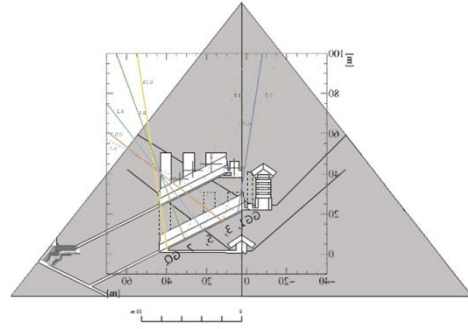

Superimposing the results of the Nagoya muography published in *The BIG VOID*, Chapter 9, page 87, on the sketch on the bottom right of the previous page. (Results also flipped horizontally)

Curiously, this information went unnoticed, yet it is an indisputable indication of a direct relationship between the two structures, which fit perfectly into an overall architectural plan incorporating the Circuit Noble and the internal ramp. None of these elements are the result of chance, but of the designers' will!

Another important piece of information linked to the discovery of the SP-NFC and to a technique used in the construction of the roofs of the two entrance chambers and in the lowering of Strabo's portcullis is the use of limestone blocks as counterweights some 30 meters from the counterweight system in the Grand Gallery GG1, to slow down and control the maneuvers. A proof of know-how and the use of this type of technique at the heart of the project.

The final direct consequence of the architecture thus reconstructed for the Noble Circuit, in relation to Strabo's text, is "*...a tortuous gallery or syringe, leading to the tomb*".

The meaning of the term "tomb" in Strabo's text is similar to the notion of a "funerary apartment", consisting of a chamber in which the mummy of the deceased is placed in a heavy sarcophagus, and an antechamber (or possibly two) in the immediate vicinity in which his personal belongings are gathered to accompany him into his new eternal life.

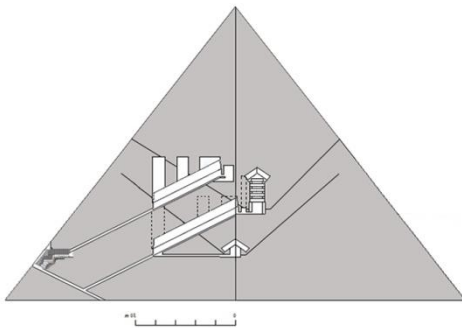

Cross-section of the pyramid incorporating the latest version of the BIG VOID with Strabo's Portcullis Chamber.

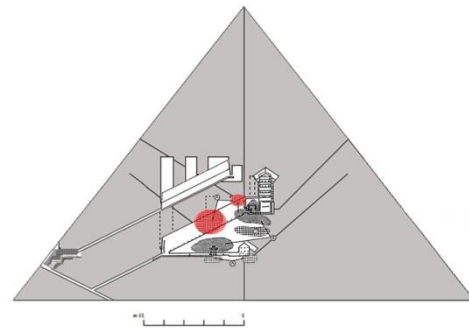

Application of the results of the 1986/87 EDF microgravimetry mission.

STRABO'S PORTCULLIS CHAMBER

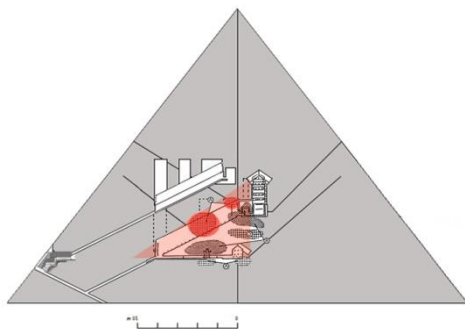

Addition (in pink) of the triangular zone protected from oblique forces resulting from the transfer of vertical loads received by the North slope of the King's Chamber roof.

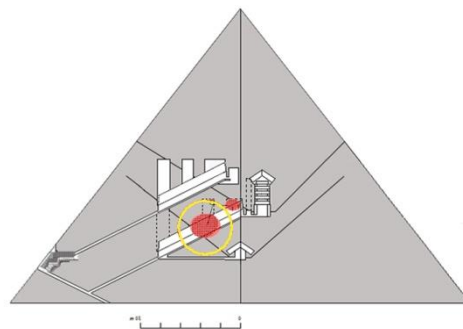

The lower density zone (red spot in the center of the circle) to the West of the Grand Gallery is less than 10 m from its center, and at the epicenter of all the cavities at the heart of the pyramid; once again, this is no coincidence!

The question that immediately springs to mind is, of course:

"Why didn't the ScanPyramids mission see an anomaly at this precise spot on the pyramid when it saw the BIG VOID a dozen meters higher up?"

The answer is also very simple:

"Muons detect voids, whereas microgravimetry detects differences in density that are not necessarily due to voids, but to a difference in materials in a specific area".

It has now been proven that the 1986/87 EDF mission had indeed detected an overdensity behind the Turah limestone rafters at the entrance; the latter's large dimensions and their compact assembly inside a mass of smaller blocks, multiplying the number of more or less wide joints, created the differences in density detected.

As a result, the large zone of under-density detected less than ten meters to the West of the Grand Gallery must be regarded as indisputable scientific information, on a par with the data acquired by the ScanPyramids mission. The position of this anomaly fits in perfectly with the architectural project conceived by the architects, with numerous parameters and clues pointing to a structured and well-constructed structure.

By discovering the BIG VOID, the ScanPyramids mission uncovered a particular parameter that was not available to me in 2003, when the Noble Circuit was conceived, nor in 2011, when *"Khufu Reborn"* was presented. In writing this Memoir, I had to go back over all the information I had acquired over almost two decades on the results of the microgravimetry mission. I discovered information that was buried in the analysis and articles of the time, and which is very telling. I'll be talking about this in the next Memoir³⁵¹ dedicated to ScanPyramids' third discovery, Cavity C1 under the North-East edge.

In this same future document, I'll also be addressing a number of issues that the architects had to resolve when establishing the programming and building site planning before the start of construction. As in a modern building site, they incorporated the idea of *"drawer operations"* to allow access³⁵² to all the interior volumes of the pyramid, whatever the phase of the work.

There will also be a chapter devoted to the Queen's Chamber, its construction and functions.

³⁵¹ In the meantime, I refer you to *Information Note N°2* of this Memoir from page 38 to page 42 . The clues to the answer are there.

³⁵² Thanks to a small detail that can be seen on several 3D models on page 44 of 2005.

But of course, this third Memoir will provide many answers regarding the existence of the internal ramp, an essential structure for the construction of the great pyramids of the 4th Dynasty: the Bent and Red Pyramids at Dahshur, and the Khufu and Khafre Pyramids at Giza³⁵³.

From the Menkaure Pyramid onwards, because of their reduced size, a new procedure replaced this internal ramp for the construction of all pyramids: "a construction gap³⁵⁴", a gap on one of the faces allowing materials to be brought into the pyramid enclosure and built "from the inside".

In the meantime, here are a few sentences written by famous Egyptologists that are direct testimonies to an indisputable fact about "building from the inside"; this reality doesn't seem to have been understood when studying the proposed construction theories.

I.E.S. Edwards³⁵⁵:

"Petrie declared himself convinced that the facing stones of the Great Pyramid had been built up to their respective courses with their outer faces already smoothed and set in position from the inside. In this way, the facing was laid first and the core filled in afterwards, so that a single ramp would have been all that was needed and three sides of the pyramid would have been completed as soon as their facing was placed. In support of this thesis, Petrie writes: "There is a small difference in angle between the (facing) blocks at their junction, which proves that the faces have not even been smoothed after they were fitted".

Dieter Arnold³⁵⁶ :

"Blocks intended to be built into foundations or core masonry, which did not need further dressing, could be left waiting, sometimes up to three years, until they were used. The other blocks that needed dressing could not be left too long, for the stone would dry fast and its hardness would increase considerably".

.../...

"There are instances, however, where blocks were already dressed down before setting, and we do not always understand under what conditions this happened".

.../...

"There is no doubt that the casing, backing and packing stones were treated as a structural unit to be built simultaneously".

Mark Lehner³⁵⁷:

About Khafre's pyramid.

"The casing stones at the top of the pyramid are much smaller... Their outsides are often staggered by a few millimeters rather than flush. This might suggest that at this level, the outer slope was cut into the blocks before they were laid, due to reduced working space".

³⁵³ And certainly for the construction of the pyramid at Meïdoum.

³⁵⁴ BUILDING IN EGYPT, PHARAONIC STONE MASONRY - Dieter Arnold - Oxford University Press, 1991, pages 179 to 181.

³⁵⁵ LES PYRAMIDES D'ÉGYPTE - I.E.S. Edwards - Tallandier, 1947 - 1972, page 187.

³⁵⁶ See note 354, pages 43, 132 and 169.

³⁵⁷ THE COMPLETE PYRAMID - Solving the Ancient Mysteries - Mark Lehner - Thames and Hudson, 1997, page 123.

STRABO'S PORTCULLIS CHAMBER

To illustrate this last point, I'm attaching two photos of the top of Khafre's Pyramid, because it's not a matter of millimeters, far from it, but rather of the way these facing blocks were laid on the nearly fifty courses still visible at the top of the Pyramid: they were put in place, already cut and surfaced to their final shape, pushed outwards from the inside!

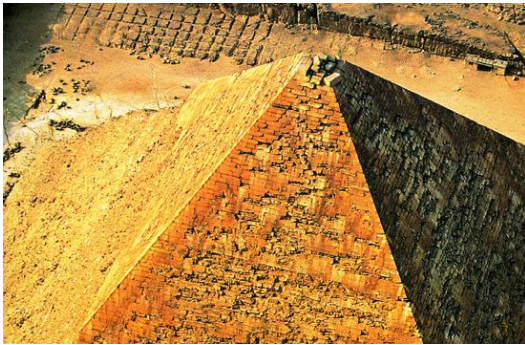

Common view, from above, of Khafre's pyramid top. Among the notable details, the pattern and regularity of the blocks in the edges are stunning. The last fifty layers are 1 cubit high, so around half a meter, for a 500 kg or less weight, a size of blocks well suited for an internal ramp travel.



An unusual view³⁵⁸ of Khafre's pyramid top from below. The layers are widely offset from one another, proving that each block had already been cut and surfaced before it was laid. There was only one way to lay them: deliver the blocks inside and push those outwards.

I also enclose two links to videos made by an ancient Egypt enthusiast³⁵⁹, Douglas Rennie³⁶⁰, which show in great detail how the Turah limestone blocks at the top of Khafre's pyramid are laid.

Go to **History for Granite** <https://www.youtube.com/watch?v=q4vV1aAgVGw> and posted just before the publication of the Memoir: <https://www.youtube.com/watch?v=43V9RTpnbk&t=920s>

These videos undermine the most common interpretation of Herodotus' text, according to which the cutting and polishing of the facing blocks was carried out at the end of the work from the top to the base.

Herodotus, II, 124-125, 127-128:

"However that may be the highest parts of it were finished first, and afterwards they proceeded to finish that which came next to them, and lastly they finished the parts of it near the ground and the lowest courses".

This text is still valid, it's the interpretation that's wrong...

Finally, I would like to point out that I have chosen to write the three Memoirs of the trilogy in the reverse order of the discoveries made by the ScanPyramids mission, for personal reasons:

- The First:

The BIG VOID is an exceptional discovery in terms of its size, volume, position and similarity to the Grand Gallery. It has been the subject of a very long scientific muon investigation by three international teams, all of which have concluded, each with its own technique, to the same result. My interpretation in the first Memoir enabled me to affirm my ideas on the construction of the superstructure above the King's Chamber. In so doing, new clues logically followed, with repercussions for my work.

³⁵⁸ Screenshot taken from the documentary "Le Mystère des Pyramides" (The Mystery of the Pyramids) directed in 1998 by Jean-François Delassus and produced by Point du Jour for France 2.

³⁵⁹ Like Matt Sibson, *Ancient Architects* (<https://www.youtube.com/@AncientArchitects>) and Keith Hamilton (<https://independent.academia.edu/KeithHamilton>). I will talk about them in my next Memoir on Cavity C1.

³⁶⁰ It's a proof that a "non-professional" can also contribute his "stone" to the knowledge of the pyramids.

STRABO'S PORTCULLIS CHAMBER

- The Second:

The SP-NFC, a chamber I had imagined over twenty years ago, would benefit from the fallout of the BIG VOID discovery, reinforcing the idea of the Noble Circuit I had announced in 2011. The official discovery of a nine-meter-long chamber behind the entrance rafters was an extraordinary stroke of luck for me, because now part of the History of Khufu's Pyramid has been written.

- The Third:

The Cavity C1 under the North-East edge, a first discovery by "chance" that didn't receive the scientific attention from the ScanPyramids mission for reasons I won't go into. That said, the first two Memoirs provide a great deal of information to support the internal ramp theory. You'll see when I publish the third Memoir on October 25, 2024.

Page 149 of my first Memoir about the BIG VOID, I ended with this sentence:

"I am absolutely convinced that Hemiunu and Ankh-haf, the architects-engineers who designed and built the Great Pyramid, were geniuses".

And I added:

"I'm even more convinced of that now".

Now, I hope that you too, after reading my first two Memoirs, will be convinced; I'm not making anything up, I'm just looking at the stones that talk to us and tell us a lot.



Hemiunu

© Madeleine Peters-Destérac



Ankh-haf

Excerpts from a recent editorial³⁶¹:

"Man fears time, but time only fears the pyramids," says an ancient Egyptian proverb. Nothing is more accurate except...

Except that an architect has arrived. A level-headed, rational architect, driven by decades of experience. You will tell me: so what? So I will answer you with another question: isn't an architect best placed to understand another despite centuries of difference?

The answer is: it's obvious.

.../...

Solve the mystery of the pyramids? The equation is simple: archeology + architecture + science. »

³⁶¹ Excerpt from the editorial by Nicolas Montigiani, editor-in-chief of *INEXPLIQUE* magazine, Special Issue No. 3: The Secrets of the Khufu Pyramid Revealed, July-August-September 2023.

15 - EPILOGUE

I began this very long Memoir by evoking the very distant origins of the last twenty-five years I've devoted to trying to solve the enigma of the Great Pyramid's construction, following a simple idea my father Henri had in January 1999 that "broke the paradigm" on which all construction theories were based: building from the "inside" instead of the "outside". This inversion was the key to the enigma, the breadcrumb thread to follow in order to overcome one obstacle after another.

On page 8, I reported the words of a note my father had written to me with this last sentence:

CONCLUSION: Operation Khufu is a child of Abidjan's first bridge.



Photo of a site meeting above a pile on Abidjan's first bridge in mid-1955. My father is second from the left, and André Ferré, the bridge's construction manager and future member of the College of Experts, is in the center, from the front. Back then, technical means of control were simple; now, computers have revolutionized construction sites.



R.A.N. public school in Abidjan, November 1958. The kid in the front row on the left can't imagine that, some forty years later, destiny will take him on a pyramid adventure for over twenty-five years because of a bridge that had just been built less than a kilometer from his school.

After nearly five years of study, the College of Experts³⁶² submitted its report³⁶³ to the French Ministry of Foreign Affairs, which, aware of the dangers to the Houphouët-Boigny Bridge, forwarded the dossier to the French Development Agency (AFD), which informed the Ivorian Minister of Infrastructure. On January 17, 2000, the latter formalized the action of the College of Experts.³⁶⁴

The situation in Côte d'Ivoire will delay renovation work on the Felix Houphouët-Boigny Bridge, which will not be launched until April 6, 2018, with the construction of fifty-six new piles being entrusted to two French companies³⁶⁵.

"The Félix Houphouët-Boigny Bridge, which was the pride and joy of the Pearl of the Lagoons and bore the scars of over fifty years of operation, had never benefited from a large-scale rehabilitation project³⁶⁶".

³⁶² See pages 7 and 8 of this Memoir.

³⁶³ Dated from February 24, 1998. The deed of delivery of the file will be registered with a Notary on June 22, 1998. The complete file will then be deposited to another Notary in June 1999 (notary fees paid by the members of the College of Experts).

³⁶⁴ Important note: all members of the College of Experts were volunteers.

³⁶⁵ Eiffage and Spie Batignolles.

³⁶⁶ Journal Info7 - Pont Houphouët-Boigny, la réouverture totale pour bientôt, by Ephrem Thora, 29/04 2021.

STRABO'S PORTCULLIS CHAMBER



Photo of the site where the piles of the first bridge were rebuilt. The technical resources available are nothing like those of the 50s. That said, the water in the lagoon has changed a great deal.

In my childhood, fish could be seen through the clear water, hence Abidjan's nickname: the Pearl of the lagoons...

Scheduled for delivery in 2021, this will not actually take place until 2023. Near thirty years passed between the first meeting of the College of Experts and the end of the risk of the bridge collapsing. My father will not have had enough time to see this positive end to a subject that concerned him personally, a reaction of a responsible engineer.

I mentioned this bridge story because it was at the origin of my work on the pyramid, which also began a long time ago, twenty-five years ago, and eventually led to the greatest discovery in Khufu's Pyramid since the 19th century: the *Strabo's Portcullis Chamber*. Without my father, ScanPyramids would never have existed. Of course, we can imagine that one day a mission would have been carried out, and that this chamber would have been discovered, as non-destructive investigation techniques made constant progress. This ScanPyramids mission, in which I was not officially able to take part even though it is the fruit of a dozen years of effort on my part, has succeeded in advancing our knowledge of the monument thanks to the teams who make it up and who are the "heroes of this scientific adventure", which has had to face some difficult moments since its official launch on October 25, 2015. I'll always be grateful to them.

My father used to say to me: *"I've only done 5% of the theory, you've done 95%"*.

I always replied: *"Without your 5%, I would have made...0%"*.



Sunset on October 24, 2014 behind the Natchez-Viduka Bridge on the Mississippi River - USA.
The next morning, my brother Bernard called to tell me that our father passed away during the night.
I always thought the photos I'd taken a few hours earlier were a symbol.

To be continued...

16 - RELATED DOCUMENT

Article published by journalist Marc Chartier on his blog PYRAMIDALES on February 25, 2011 about the "multiple-purpose" entrance to the Great Pyramid according to Jean-Pierre Houdin

Pyramidales

Théories sur la construction des pyramides égyptiennes

Friday February 25, 2011

The Great Pyramid "multiple purpose" entrance, according to Jean-Pierre Houdin³⁶⁷

Marc Chartier

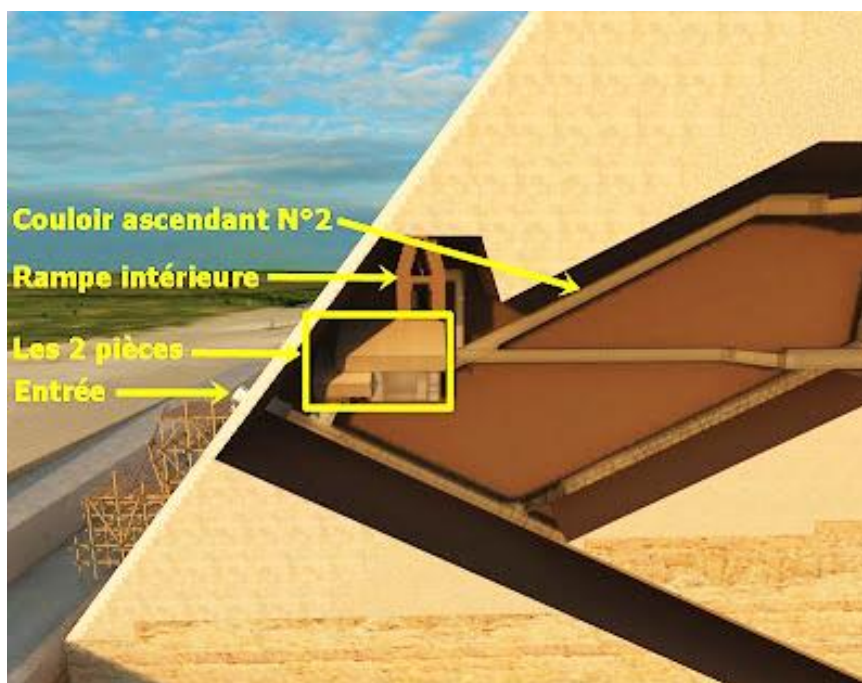

March 30, 2007: *Khufu Revealed*.

January 27, 2011: *Khufu Reborn*.

Two dates that punctuate, for the architect Jean-Pierre Houdin, some twelve years of research on the "why" and especially the "how" of the pyramids of Egypt. Two important moments, punctuating the evolution of a "theory" whose premises go back to 1999, when the engineer Henri Houdin, father of Jean-Pierre, had the intuition that something was wrong with the "normalized" presentation of the construction site of the Great Pyramid. Hence the idea of the internal ramp, which will see thereafter the developments that we know.

In an exclusive interview granted to *Pyramidales*, Jean-Pierre Houdin presented the main lines of *Khufu Reborn*, namely his new reading of the internal structures and the environment of Khufu's Pyramid.

Different notes of this blog have already been devoted to this inventory: the antechambers, the King's Chamber, the "Noble Circuit", the layout of the Giza Plateau...

The entrance to the pyramid has also been re-read and Jean Pierre Houdin has provided the following information for the readers of *Pyramidales*.

³⁶⁷ <https://pyramidales.blogspot.com/2011/02/lentree-usage-multiple-de-la-grande.html>

STRABO'S PORTCULLIS CHAMBER



The entrance of the pyramid and its scaffolding

We are (approximately) in the year - 2550. King Khufu, pharaoh and sovereign ruler of Egypt, is dead. Long live the King!

His body is transported to Giza in his Solar Boat to the lower temple, where the priests must proceed to the mummification, a ritual that will last seventy days. The pharaoh is then ready for his great journey to the Imperishable Stars, transiting through the Royal Causeway of his pyramid, built for this sole circumstance of the solemn funeral.

The funeral procession begins by going up the monumental causeway that connects the temple of the valley to the upper temple, at the foot of the eastern face of the pyramid. *There,* comments Jean-Pierre Houdin, *"the priests proceed to the ceremony of the opening of the mouth in order to give the King back the use of his senses. He then recovers his speech and can appear before Osiris for the weighing of souls. No reproach having appeared during his confession, he is ready for eternity in the afterlife."*



Ceremony at the Upper Temple

At sunset, the procession reaches the entrance of the last residence of the pharaoh - "his" pyramid -, more than seventeen meters above the ground on the northern face.

To do so, it takes a wooden scaffolding, built many years ago, which gives access to the interior of the monument. It is then about to enter the bowels of the monument to reach the King's Chamber, where the voluminous granite sarcophagus was put in place, because of its size, in the year of its construction.

"Service circuit" and "Noble Circuit"

According to Jean-Pierre Houdin, the funerary procession will indeed enter through the outlet of the descending corridor on the North face but, contrary to what is commonly believed, will abandon the latter a few meters further on, ignoring the entire route that follows it: ascending corridor (to which we will now add the precision "N° 1"), Grand Gallery, Portcullis Chamber, access corridor (to which we will also add the precision "N° 1") to the King's Chamber, a route that visitors from all over the world join, since tourism and curiosity exist, by taking the break-in tunnel dug in the North/South axis by the Caliph al-Ma'mun in 820 CE.

STRABO'S PORTCULLIS CHAMBER

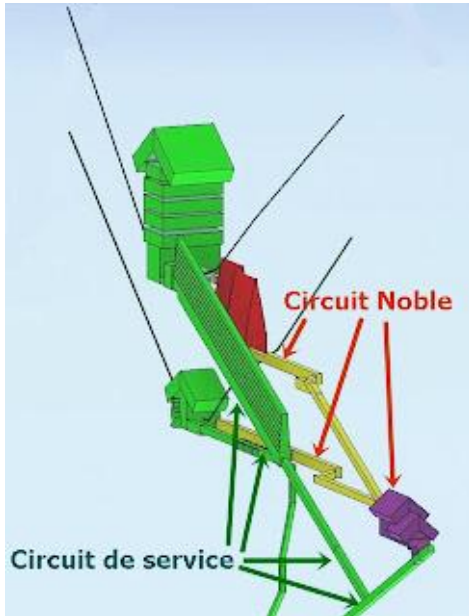

This route will not be followed, and for good reason: it has been blocked in several places. It was used, as a "service Circuit", during the whole period of the construction of the King's Chamber and the strange structure that covers it.

At the end of this construction, which had become useless, it was abandoned to the silence of the stones, until it was frequented by "visitors", more or less well-intentioned, who were far from imagining that such was not the true circuit for the royal funeral.

The procession will follow, according to the indications of Jean-Pierre Houdin, what we could call a "second itinerary", but which in reality, to use the terms of the architect, is the "Noble Circuit", the one that was conceived and built for the only day of the solemn ceremony of the royal funeral.

Consequence of this configuration, unknown to this day: the original entrance to the Great Pyramid, in order to give access not only to the "service Circuit", but also and above all to the "Noble Circuit", must include in its very structure this functional duality, which is supposed to remain secret so as not to give any indication to the eventual desecrators of the royal burial. Proof of this is that the Caliph al-Ma'mun and his soldier-sappers did not succeed in detecting the true entrance to the monument, but undertook to dig at a lower level to lead to... the "service Circuit"!

Presence of clues

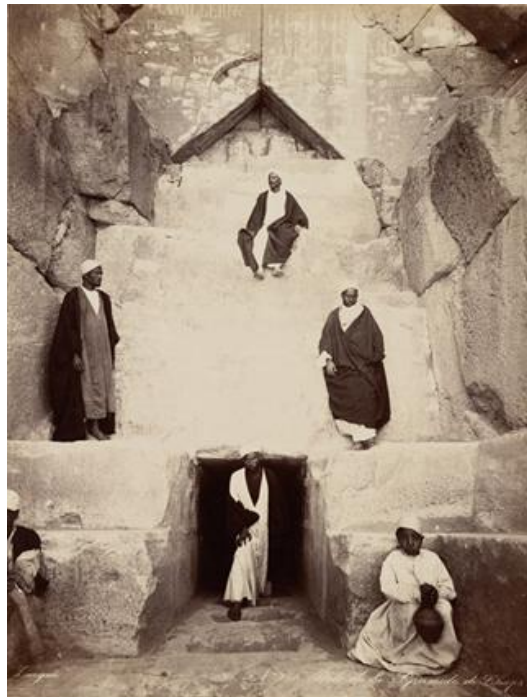

Excluding the hole of al-Ma'mun, which is like a wart, even very useful today for the access of the tourists, in the northern face of the pyramid, and taking into account the fact that this pyramid is, since several centuries, deprived of its facing blocks in Turah limestone, which clues can be revealing of the true entry of the "Noble Circuit"?

STRABO'S PORTCULLIS CHAMBER

Jean-Pierre Houdin enumerates them thus:



Chevrons and "Strabo's stone"

- the Turah limestone chevrons above the original entrance are oversized for the covering of the descending corridor (two cubits wide, i.e. 1m 05) and, moreover, much too high in relation to it;
- We can see on the spot, by measuring the existing oblique stops, that six pairs of rafters are missing in the lower part and three pairs in the upper part: the lower series covered a void, while the upper series constituted an overlap of the roof, extending a second void *"that the Egyptian builders,"* says Jean-Pierre Houdin, *"who were sparing with time and materials, must have had a very good reason to build. The current large hole did not exist at the time. Everything that is visible today was embedded in the mass of masonry and set back behind the original North face, some ten meters away. Closest to the face, a first room (where the current hole is), was located just above the descending corridor and a vertical access well, centered in the room, directly connected these two structures. The rest of the descending corridor is supposed to have been used by the funeral procession, but in reality it was only used by the workers of the pyramid construction site;*

STRABO'S PORTCULLIS CHAMBER

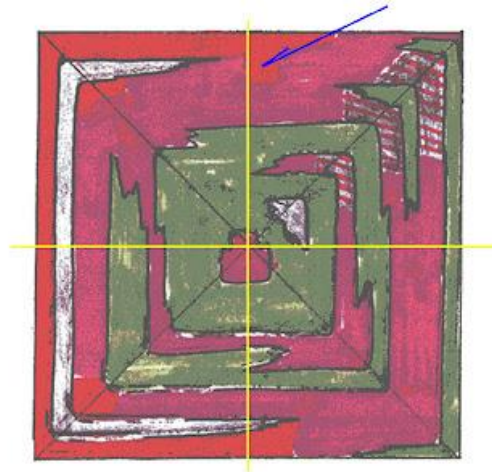

Arrow: overdensity zone

- Measurements carried out 25 years ago by microgravimetry," continues Jean-Pierre Houdin, "detected an anomaly, namely the presence of a zone of strong overdensity under the North face of the pyramid, in the exact extension of the chevrons of the entrance. This zone is located east of the North/South axis, thus in the alignment of the known corridors of the pyramid. Moreover, this overdensity stops at the 2nd section of the supposed internal ramp. (1)

- the fluted block inserted under the first pair of chevrons, and previously stored at the bottom of the second room, was visibly pushed from the inside, traces of mortar overflowing under the right chevron. In front of this block, one can see that the limestone floor has been grouted with plaster and has received a surfaced and perfectly flat finish;

- the fluted block does not go all the way to the tip of the opening; a triangle about 40 cm high has been filled in with masonry centered on the chevrons ridge.

About this stone, the Greek geographer Strabo (1st century B.C.) wrote: "At a certain height on one of its sides is a stone that can be removed, and, once removed, reveals the entrance to a tortuous gallery or syringe, leading to the tomb." (2) Hence its current name of "Strabo's stone".

A single entrance leading to two rooms



STRABO'S PORTCULLIS CHAMBER

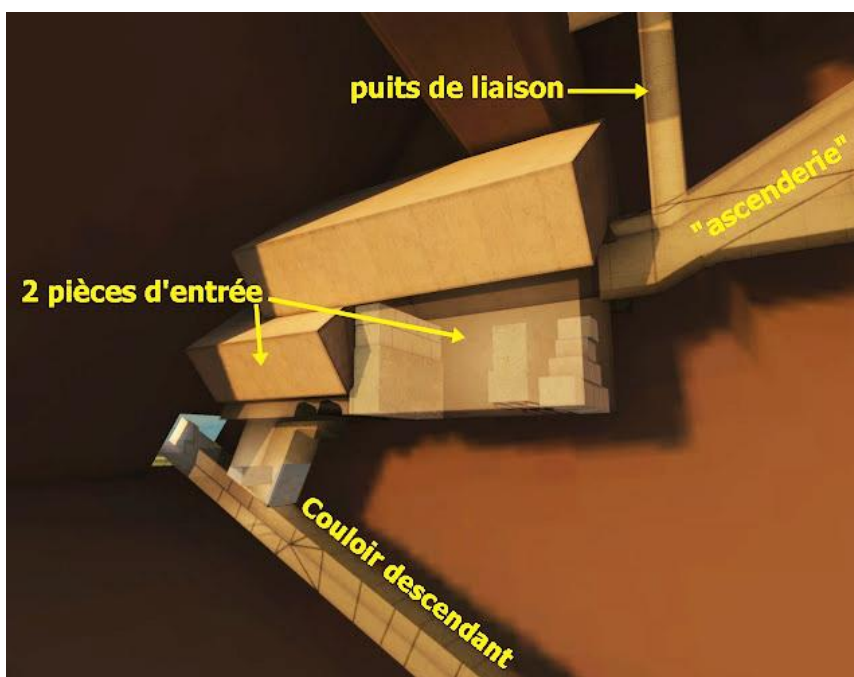

Faced with these observations, I had proof," Jean-Pierre Houdin continues, "that other chevrons had been placed up to a very small distance from the face, in front of the chevrons currently visible. It was therefore obvious that in the area of the current gaping hole, there were two rooms, one in front of the Strabo stone, and the other behind this stone, slightly offset in height.

"I then understood that the Egyptians, great architects that they were, had imagined a single entrance to serve several corridors at once. This entrance could lead to any room in the monument, and thus serve for the funeral of Khufu and, at any other time, for access to the site during the construction of the pyramid.

"The two rooms under the chevrons made it possible to get a direct connection with the descending corridor and to link it with a second series of corridors that led to the Queen's Chamber and the King's Chamber without passing through the Grand Gallery."

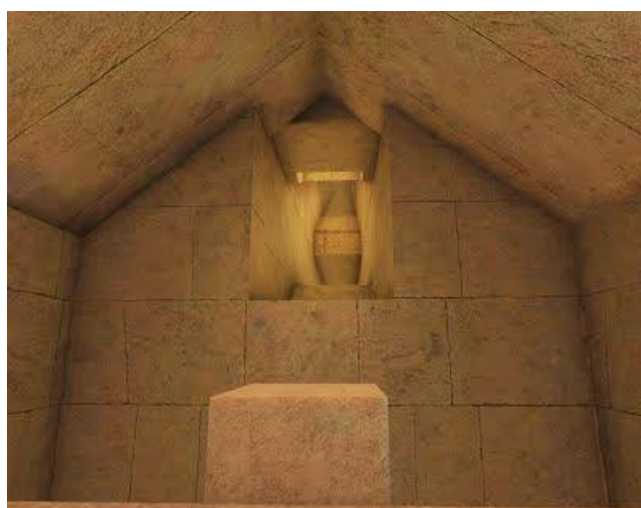

STRABO'S PORTCULLIS CHAMBER



By the complexity of its configuration, the original entrance of the pyramid is thus characterized by a clever diversity of use: it gives access, by the descending corridor, to the "service Circuit" (of no use at the end of the construction site), and it opens on the "Noble Circuit", which immediately comprises two distinct axes: one, horizontal, in the direction of the Queen's Chamber (let's not forget that this room was intended, in case of premature death of the King, to accommodate his burial); the other, ascending, as the first part of the route leading to the King's Chamber.

The two successive rooms have the function of starting the "Noble Circuit" (the "Royal Way") deep inside the mass of the pyramid (the rear of the second room is about 16 meters from the façade). Contrary to all the previous pyramids, the King's Chamber is very high up in the mass of the pyramid; therefore, it is no longer a question of connecting it by a "descending corridor", which opens practically perpendicularly to the face, but first by an "ascending corridor" (more or less parallel to this face, opening tangentially and no longer perpendicularly: a "whistle" configuration that is very complex to deal with), and then by a horizontal corridor (No. 2) opening on the two antechambers. Moreover, the passage of the internal ramp in the area would have had the effect of cutting off the ascending corridor N° 2, through which the funerary "Noble Circuit" to the King's Chamber begins; the simplest and most economical solution was to push the departure of this corridor farther into the mass, with the two horizontal entrance chambers serving as connecting and transfer modules.



Worker's exit route

STRABO'S PORTCULLIS CHAMBER

At the same starting point, a well is connected to the internal ramp next door, for the evacuation of the last workers: "*At the end of Khufu's funeral*", Jean-Pierre Houdin explains, "*and after having sealed the pyramid at several 'sensitive' points (chamber, antechambers, access corridor, entrance room), the workers are supposed to have left the funeral circuit via the internal ramp by joining it through a connecting well dug just behind the second entrance room, at the starting point of the second ascending corridor. The designers had previously simulated this device in the construction site model dug into the bedrock some fifty meters east of the pyramid.*"

Previously, the priests and other officials of the funeral ceremony left the pyramid as they had entered it, taking exactly the same route, as a result of the nobility of their function.

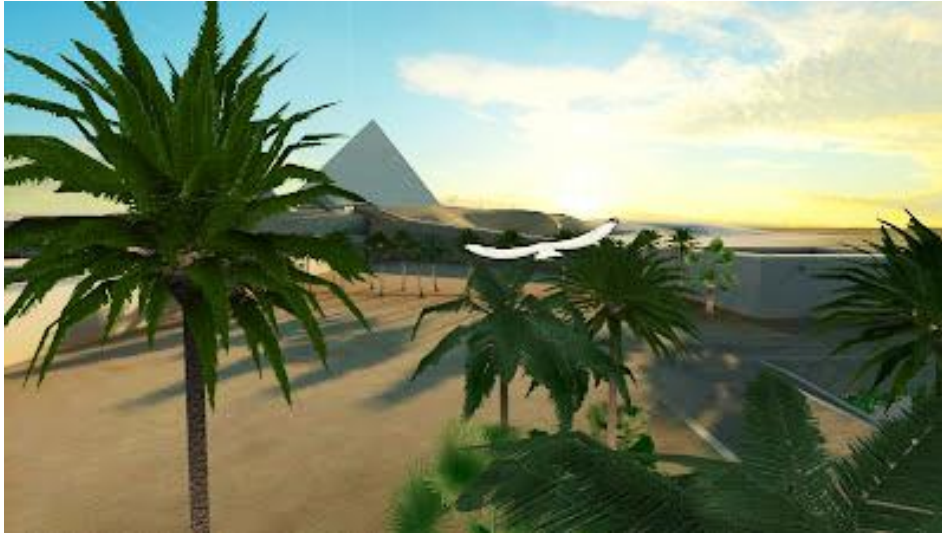

(1) The internal ramp was one of the major elements of *Khufu Revealed*. It is obviously still present in *Khufu Reborn*, but with variations that will be the subject of a future note in *Pyramidales*.

(2) The exact translation of the Greek text, as confirmed for example by Ian Lawton, author of *Giza, the Truth*, in a letter addressed to Jean-Pierre Houdin, is indeed "*leading to the tomb*" (and not "to the foundations"). It is the one proposed by Amédée Tardieu: "*At a certain height on one of its sides is a stone that can be removed, and, once removed, reveals the entrance to a tortuous gallery or syringe, leading to the tomb*".

Illustrations: copyright Jean-Pierre Houdin/Dassault Systèmes

Numerous links to the *Pyramidales* blog about *Khufu Reborn* are added at the end of the present Memoir page 167

STRABO'S PORTCULLIS CHAMBER

17 - BIBLIOGRAPHY

THE CONSTRUCTION OF KHUFU'S PYRAMID: TOWARDS THE END OF THE MYSTERIES?

Jean-Pierre Houdin, Henri Houdin - Annales des Ponts et Chaussées - ELSEVIER N°101, January-March 2002

EGYPT: THE CONSTRUCTION OF THE GREAT PYRAMID

Henri and Jean-Pierre Houdin - TRAVAUX International N°792, December 2002

KHUFU'S PYRAMID

Jean-Pierre & Henri Houdin - Editions du Linteau, 2003

THE CONSTRUCTION OF THE GREAT PYRAMID

Jean-Pierre Houdin - Actes du 9^{ème} Congrès International des Egyptologues - Grenoble, 6-12 septembre 2004 - Volume I & II PETERS, 2007

KHEOPS, THE SECRETS BEHIND THE CONSTRUCTION OF THE GREAT PYRAMID

Jean-Pierre Houdin - Farid Atiya Press 2006 - Editions du Linteau, Farid Atiya Press, 2008

KHUFU, THE SECRET OF THE CONSTRUCTION OF THE GREAT PYRAMID

Jean-Pierre Houdin - Farid Atiya Press 2006

HOW THE PYRAMIDS WERE BUILT

Bob Brier - ARCHAEOLOGY - Archaeology Institute of America, May-June 2007

THE SECRET OF THE GREAT PYRAMID

Bob Brier & Jean-Pierre Houdin - Smithsonian Books - HarperCollins, 2008

THE SECRET OF THE GREAT PYRAMID

Bob Brier & Jean-Pierre Houdin - Smithsonian Books - HarperCollins - Fayard, 2008

UPDATE: BUILDING THE GREAT PYRAMID

Bob Brier - ARCHAEOLOGY - Archaeology Institute of America, July-August 2009

KHUFU'S PYRAMID REVEALED

Jean-Pierre Houdin - Farid Atiya Press, 2009

KHUFU'S PYRAMID REVEALED

Jean-Pierre Houdin - Farid Atiya Press, 2009

A COMPUTER SIMULATION TO DETERMINE WHEN THE BEAMS IN THE KING'S CHAMBER OF THE GREAT PYRAMID CRACKED

Richard Breitner, Jean-Pierre Houdin and Bob Brier - JARCE 48, 2012

THE MYSTERY OF THE PYRAMIDS

Jean-Philippe Lauer - Presses de la Cité, 1974

THE NIL:HOPE AND ANGER - From wisdom to excess

Jean Kérisel - Presses des ponts et Chaussées, 1999

THE GENIUS AND DEMESNE OF A PHARAOH: KHEOPS

Jean Kérisel - Stock, 1996

THE CHAMBER OF KHÉOPS - Architectural analysis

Gilles Dormion - Fayard, 2004

CHEOPS PYRAMIDE - Architecture of the funerary apartments, plan 1 to 13

Gilles Dormion - 1996

L'ARCHITETTURA DELLE PIRAMIDI MENFITE, PARTE IV

V. Maragioglio & C. Rinaldi - Centro per le Antichità e la Storia dell'Arte del Vicino Oriente - Rome, 1965

THE PYRAMIDS OF EGYPT

I.E.S. Edwards - Tallandier, 1947 - 1972

BUILDING IN EGYPT, PHARAONIC STONE MASONRY

Dieter Arnold - Oxford University Press, 1991

HOW THE GREAT PYRAMID WAS BUILT

Craig B. Smith - Smithsonian Books - HarperCollins, 2006

THE COMPLETE PYRAMID - Solving the Ancient Mysteries

Mark Lehner - Thames and Hudson, 1997

PAPYRI FROM THE RED SEA (OUADI EL-JARF, GULF OF SUEZ),

Pierre Tallet - Académie des Inscriptions & Belles Lettres - CRAI/2013, II (April-June), p. 1015-1024

STRABO'S PORTCULLIS CHAMBER

PAPYRI FROM THE RED SEA (OUADI EL-JARF, GULF OF SUEZ),
Pierre Tallet - Académie des Inscriptions & Belles Lettres - *CRAI* 2013, II (April-June), p. 1015-1024

THE PAPYRUSES OF THE RED SEA 1: MERER'S DIARY (P. Jarf A and B)
Pierre Tallet - MIFAO 136, 2017

THE HARBOR OF KHUFU on the Red Sea Coast at Wadi al-Jarf, Egypt
Pierre Tallet & Gregory Marouard - *Near Eastern Archaeology* 77:1 (2014)

THE WADI EL-JARF SITE: A HARBOR OF KHUFU ON THE RED SEA
Pierre Tallet - *Journal of Ancient Egyptian Interconnections*, 2013

THE PYRAMIDS AND TEMPLES OF GIZEH
Sir W. M. Flinders Petrie - *Field & Tuer*, 1883

THE SECRET OF THE BUILDERS OF THE GREAT PYRAMIDS: KHEOPS
George Goyon - *Pygmalion*

THE MYSTERY OF THE PYRAMIDS
Jean-Philippe Lauer - *Presses de la Cité*, 1974

DIE ÄGYTISCHEN PYRAMIDEN, VOM ZIEGELBAU ZUM WELTWUNDER
Rainer Stadelmann - von Zabern publishing house, Mainz 1985-1997

THE PYRAMIDS
Ahmed Fakhry - University of Chicago, 1961

OPERATION CARRIED ON AT THE PYRAMIDS OF GIZEH
Richard Willian Howard Vyse - 1840-1842

THE PYRAMIDS OF GIZEH
John Shae Perring - 1839-1842

THE GREAT PYRAMID OF KHUFU AND ITS MORTUARY CHAPEL
Selim Hassan - *Excavations at Giza, Season 1938/39 - Vol X*

NEW RESEARCH IN HATNOUB'S ALABASTER QUARRIES: THE P QUARRY
Yannis Gourdon, co-director of the Hatnoub archaeological mission, Institut Français, Cairo, October 7, 2018.

THE ENGINEERING GEOLOGY OF ANCIENT WORKS, MONUMENTS AND HISTORICAL SITE - Preservation and Protection. Extracts from proceedings edited by A.A. Balkema / Rotterdam / Brookfield - 1988.

SHIP TIMBER AND THE REUSE OF WOOD IN ANCIENT EGYPT
Pearce Paul Creasman - *Journal of Egyptian History* 6 (2013) 152-176

TECHNICAL AND PHYSICAL ASPECTS OF OPERATION KHEOPS
Jacques Lakshmanan and J.-C. Erling - *ANNALES de l'Institut Technique du Bâtiment et des Travaux Publics* - May 1987

LETTERS FROM ENGINEER WAYNMAN DIXON TO GEORGE RESINER AND ALAN ROW
Museum of Fine Arts, Boston Archives

EGP 1 - Egyptian Department Correspondence 1905-1980
Box 2, Correspondence "D" - Folder 1
Typewritten letter from Dixon to Reisner, January 27, 1925

EGP 1 - Egyptian Department Correspondence 1905-1980
Box 5, "Reisner, Mary and George."
2 page handwritten letter to Reisner, April 13, 1925
1 page printed newspaper article, January 10, 1924

The two articles simultaneously published online just after the March 2, 2023 press conference:

Localization and shape determination of a hidden corridor in the Great Pyramid of Giza using non-destructive testing

Mohamed Elkarmoty, Johannes Rupfle ... Hany Helal

Mohamed Elkarmoty et al, *NDT&E International*, <https://doi.org/10.1016/j.ndteint.2023.102809>

Precise characterization of a corridor-shaped structure in Khufu's Pyramid by observation of cosmic-ray muons

Sébastien Procureur, Kunihiro Morishima...

Procureur, S., Morishima, K., Kuno, M. *et al.* Precise characterization of a corridor-shaped structure in Khufu's Pyramid by observation of cosmic-ray muons. *Nat Commun* **14**, 1144 (2023).
<https://doi.org/10.1038/s41467-023-36351-0>

STRABO'S PORTCULLIS CHAMBER

18 - USEFUL LINKS TO DISCOVER MY WORK

ACGP WEBSITE

Association Construire la Grande Pyramide, created in 2003 to support my research on the Great Pyramid
<https://www.construire-la-grande-pyramide.org>

PYRAMIDALES, blog by Marc CHARTIER, journalist

Jean-Pierre Houdin: "Our knowledge of the Khéops pyramid and the other great smooth pyramids of the 4th Dynasty, which form an indissociable whole, continues to grow".

<https://pyramidales.blogspot.com/2010/03/jean-pierre-houdin-toujours-plus-loin.html>

"There's no reason why you shouldn't study pyramid construction, especially if you're an architect, just because you don't have a 'certified Egyptologist' badge" (Jean-Pierre Houdin).

<https://pyramidales.blogspot.com/2011/01/il-ny-aucune-raison-de-sinterdire.html>

"The Egyptians built what they knew how, in the simplest, most logical way possible" (Jean-Pierre Houdin)

<https://pyramidales.blogspot.com/2011/01/les-egyptiens-construisaient-ce-qu'ils.html>

Apothème: a question... and Jean-Pierre Houdin's interpretation

<https://pyramidales.blogspot.com/2009/10/apotheme-une-question-et.html>

Transporting stone blocks and monoliths to build the Great Pyramid: the ingenuity of Egyptian builders, according to Jean-Pierre Houdin

<https://pyramidales.blogspot.com/2011/02/transport-des-blocs-de-pierre-et.html>

Will infrared thermography reveal more of the Great Pyramid's secrets?

<https://pyramidales.blogspot.com/2011/02/la-thermographie-infrarouge-revelera-t.html>

"Khufu Reborn, one year on

<https://pyramidales.blogspot.com/2011/12/kheops-renaissance-un-apres.html>

"Without a valid explanation for the placement of the facing blocks, we cannot explain the construction of the pyramids themselves" (Jean-Pierre Houdin).

<https://pyramidales.blogspot.com/2013/05/sans-explication-valable-pour-la-mise.html>

Backed by architectural and topographical evidence, Jean-Pierre Houdin is convinced that the Giza Sphinx represents King Khufu.

- 1^{ère} part

https://pyramidales.blogspot.com/2013/07/preuves-architecturales-et_17.html

- Part 2

<https://pyramidales.blogspot.com/2013/07/preuves-architecturales-et.html>

- Part 3

https://pyramidales.blogspot.com/2013/07/preuves-architecturales-et_31.html

Numerical simulation to determine when the beams in the Great Pyramid's King's Chamber cracked

<https://pyramidales.blogspot.com/2014/02/une-simulation-numerique-pour.html>

OTHER LINKS RELATED TO THIS DOCUMENT

Article published in 2006 in the New York Times:

<http://www.nytimes.com/2006/05/27/world/africa/27houdin.html?scp=1&sq=jean-pierre%20houdin&st=cse>

It's all about DNA.

<https://www.youtube.com/watch?v=iVXHDJzmqm0>

Article published in JARCE (Journal of American Research Center in Egypt) on the cracking of the ceilings in the King's Chamber and another on the 34 clues

<https://independent.academia.edu/JeanPierreHoudin>

Summary of the 2011 Great Pyramid project

https://www.youtube.com/watch?v=CwcCTPL-S_0&feature=youtu.be

The counterweight in the Grand Gallery version 2007

<https://vimeo.com/showcase/3407622/video/127310120>

The counterweight in the Grand Gallery version 2011

<https://www.youtube.com/watch?v=xE39WfQRZL4>

Interview by Sharon Janet Hague for the "Stars of Egyptology" series published on her blog www.sharonjanethague.com

STRABO'S PORTCULLIS CHAMBER

PHOTO CREDITS AND ILLUSTRATIONS

ScanPyramids, Gilles Dormion, Albert Ranson, Jean-Pierre Houdin, Dassault Systèmes, Eduard Spelterini, Emissive, Google Earth, Google (Fair Use), Franck Monnier, Mathias Glad, Jon Bodsworth, Bruno Neyret, Benoît Marini, Vincent Steiger, Emmanuel Guerriero, Pierre Gable, *Nature* Magazine, Michelle Houdin-Plessix, D. Laisney, G. Castel, Gregory Marouard, Th. Sagory (IFAO), Q. Lavigne (IFAO), Selim Hassan, Denis Denoël, Kunihiro Morishima (Nagoya University), Sébastien Procureur (CEA), Pr. Hui Duong Bui, Rudolph Gantenbrinck, Pyramid Rover, Shaun Whitehead (Robot Djedi, Edgar Brothers, Fonds Société des Entreprises Boussiron, MFA Boston, Jean-Claude Barré, Madeleine Peters-Destérac.

ACKNOWLEDGEMENTS

First and foremost, THANK YOU to Michelle, whom I embarked on my "*Adventure to the Pyramids*" almost 25 years ago, and who has always encouraged me to persevere and supported me through thick and thin. When I embarked on this adventure, she asked only one thing of me: to make a serious commitment to my quest for knowledge, something I've respected ever since.

A big THANK YOU to the members of the ACGP³⁶⁸ (Association Construire la Grande Pyramide) who have supported me unreservedly since its creation in 2003 in my research into the Cheops pyramid. I have a special thought for those who have left us since the beginning of this very long journey on a quest for knowledge.

Office

Chairman : Laurent CHAPUS
General secretary: Jean BILLARD

Treasurer: Chantal MAZIERES
CST Chairman: François LEVIEUX

Founding members

Paul ALLARD *
Charles BAMBADE *
Jean BILLARD
Hubert CURIEN *
Emilienne DUBOIS
Dominique FERRE
Henri HOUDIN *
André GUILLAUME *
Paul LEMOINE *
François LEVIEUX
Bernard MARREY
Jean-Claude PARRIAUD *
Georges REME *

Laurent SARVER
Ruth SCHUMANN ANTELME
Jean-Louis SIMONNEAU
Daniel SOLVET *
IESF French Engineers and Scientists
IREX Institute for Research
and Experimentation

Full members

Denis DENOEL
Bruno NEYRET
Chantal MAZIERES
Anne MAHIEU
Marc BUONOMO
Jean CARAYON
Laurent CHAPUS
Jean-François COSTE
Pierre GRUSSENMEYER
Jacques HUILLARD
Hubert LABONNE *
Gérard LEDIEU
Bertrand LEMOINE

Honorary members

Frédéric ABBAL
Taha ABDALLA
Eric ALIX
Farid ATIYA *
Mourad M. BAKHOUM
Fabien BARATI
Hassan BEHNAM
Jean BERTHIER *
John BODSWORTH
Richard BREITNER
Bob BRIER
Thierry BRIZARD
François BROUSSE
Hui Duong BUI *
Jean-Louis CHENEL
Olivier AMET

Guy DELBREL
Michel GERGONNE
Emmanuel GUERRIERO
Hany HELAL
Mahmoud ISMAIL
Christian JACQUET
Jeffrey KEARNEY
Patrick LONGUEVILLE
Jacques JAWORSKI
Alain DUGOUSSET
Atef MOUKHTAR
Jean-Jacques URBAN-GALINDO
Mounir NEAMATALLA
Robert GOLDBERG
Jack BAKLAYAN
Jack SCAPPARO *

Hervé PIQUET
Guillaume BUTTY
Laurent DONDEY
Philippe ETCHEVERRY
Lionel WOOG
Jean-François BORDENAVE
Jean-Christian KIPP
Sophie KEROB-SCHONBORN
Jérôme STEVENS
Pierre DELETIE *
Wafiq SHAMMA
Mehdi TAYOUBI
François THIERRY
Raphaël THIERRY *
Essam EL-MAGHRABY *
Eric LEMASSON

* Deceased members

A big THANK YOU also to the companies and individuals listed below whom, by funding the ACGP through sponsorship, have enabled me to pursue my research on the Cheops Pyramid since 2003.



368 www.construire-la-grande-pyramide.org

STRABO'S PORTCULLIS CHAMBER

A big THANK YOU to all those involved in the SCANPYRAMIDS mission below who, thanks to their skills, know-how and technologies, succeeded in "making the stones talk" and thus record invaluable discoveries for my research into the Khufu pyramid.

F-lab. Nagoya University: Kunihiro Morishima, Mitsuki Kuno, Akira Nishio, Nobuko Kitagawa, Yuta Manabe, Masaki Moto.

KEK: Fumihiko Takasaki, Hirofumi Fujii, Kotaro Satoh, Hideyo Kodama, Kohei Hayashi, Shigeru Odaka.

IRFU, CEA, Université Paris Saclay: Sébastien Procureur, David Attié, Simon Bouteille, Denis Calvet, Christopher Filosa, Patrick Magnier, Irakli Mandjavidze, Marc Riallot.

Université Laval in Quebec City: Xavier Maldague, Matthieu Kelin, Clemente Ibarra-Castanedo
Jean-Claude Barré

Cairo University: Hany Helal, Mustapha Ezzy, Yasser Elshayeb and the faculty students involved in the project.

HIP Institute: Mehdi Tayoubi, Benoit Marini, Vincent Steiger, Nicolas Serikoff, Laure Kaltenbach, Laurent Chapus, Henri Pomeranc, François Schuiten, Philippe Forestier.

NHK: Toshihide Yabuki, Takeshi Shibasaki, Koichi Jo, Hideo Kado, Takumi Hisaizumi, Mutsumi Funato

Technical University of Munich: Christian Grosse, Johannes Rupfle.

Dassault Systèmes: Bernard Charlès.

Emissive: Emmanuel Guerriero, Pierre Gable and the 3D modelers involved in the project.

NEP: Yoshikatsu Date.

Suave images: Makiko Sugiura.

Ain Shams University: Tamer Elnady.

Inria: Jean-Baptiste Mouret.

Special thanks to Dr Hiroyuki Tanaka for introducing me to muography and making this mission possible.

A big THANK YOU also goes to the companies listed below who funded the SCANPYRAMIDS mission.

The Dassault Systèmes Foundation

NHK

Suez

IceWatch

The Dassault Group

Batscop

Emissive

Itekube

Parrot

ILP

Kurtzdev

Gen-G

Schneider Electric

Octave & Octave

A big THANK YOU also to the people who helped me write, correct or preview the manuscript of this memoir: Marc Chartier, Jean Billard, François Levieux, Jean Carayon, Gérard Ledieu, Pierre Gable, Fabien Barati and Jean-Jacques Urban-Galindo,

Finally, I would like to THANK these two highly respected French institutions for awarding me two prizes for my work on the Cheops pyramid:

In 2006, the PRIX MONTGOLFIER, awarded by the "Construction and Fine Arts" Committee of the Société d'Encouragement pour l'Industrie Nationale³⁶⁹, founded in 1801 by scientist Jean-Antoine Chaptal with the support of First Consul Bonaparte.



In 2010, the MEDAILLE D'ARGENT DE L'ARCHÉOLOGIE awarded by L'ACADÉMIE D'ARCHITECTURE³⁷⁰, which originated in 1840 as the Société Centrale des Architectes when it was founded to promote quality in architecture.



³⁶⁹ <https://www.industrienationale.fr/>

³⁷⁰ <http://academie-architecture.fr/>