

Egypt Fourth Dynasty

# **KHUFU'S PYRAMID**

The “Inside-Out” construction theory

## **34 CLUES IN SUPPORT OF THE THEORY**



Study carried out by Jean-Pierre Houdin

Honorary Architect

Paris, January 13 – 2011

**The 34 clues can be grouped as follows:**

**1. Clues about the internal ramp**

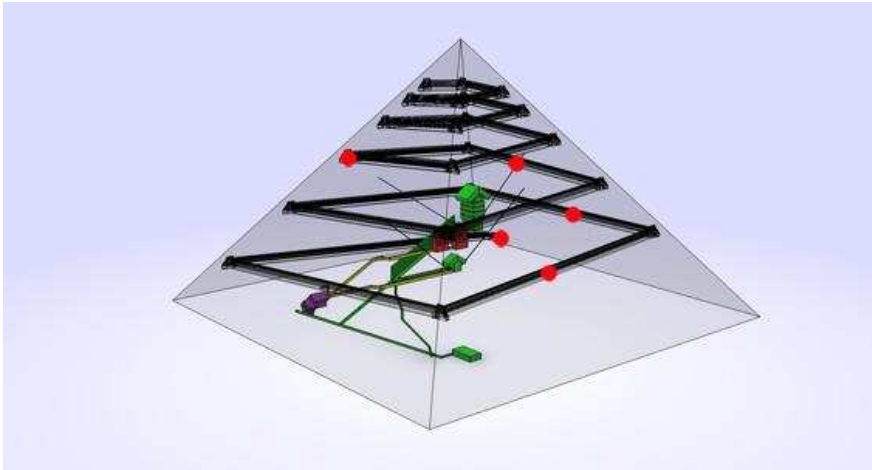

**2. Clues about the internal distribution**

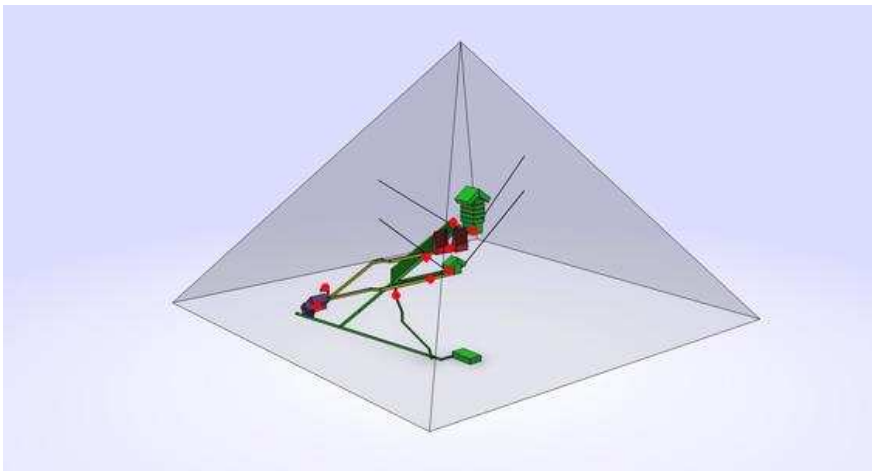

**3. Clues about the external ground installations**

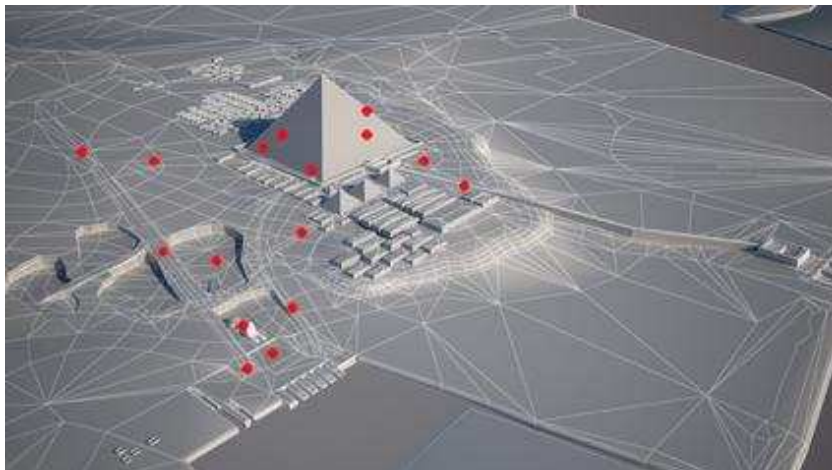

Important note : The evidence presented in this report was gathered subsequent to the publication of the original theory. It should thus be viewed as part of the on-going validation process of the original theory rather than a part of its inception. *The original theory was conceived without the benefit of these clues.*

# 1

## Clues about the internal ramp

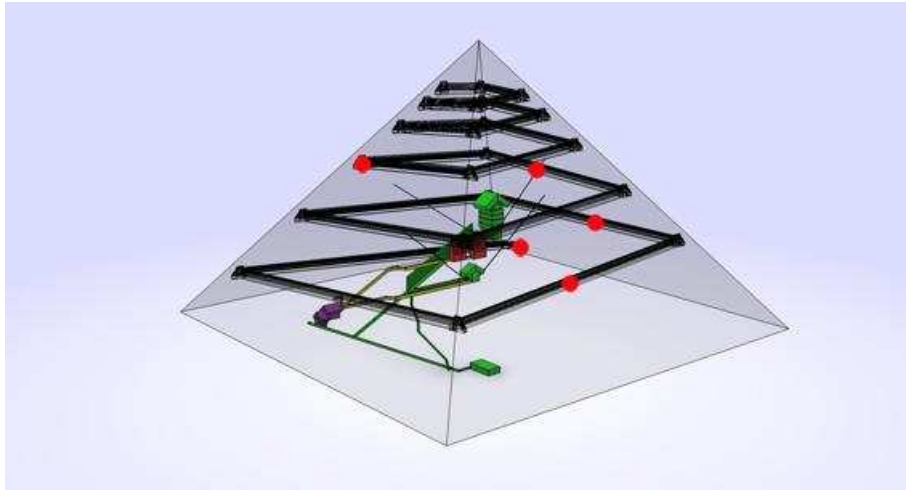

## The anomaly detected by microgravimetry



In blue, the first section of the internal ramp, beginning at the Southern face near the Southeast corner, and running North/South along the Eastern face of the pyramid. In yellow, the fourth section of the internal ramp running East/West along the Southern face of the pyramid. In the yellow circle, the location of Bob's room.

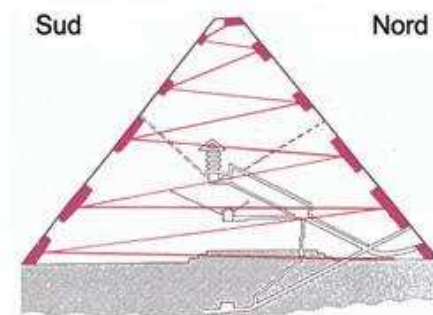
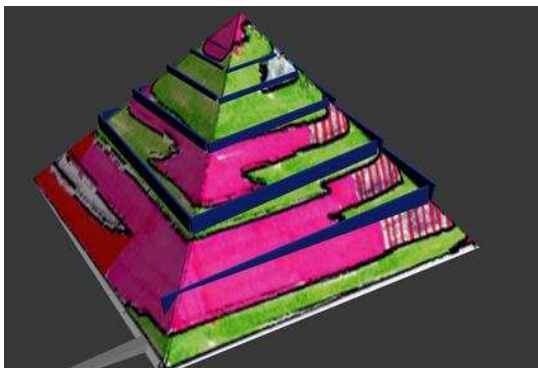

Right : a 3D application of the results with a vertical projection of the sections of the internal ramp.  
 Left : a drawing from the author of the above image—the ascending spiral clearly shows a low-density anomaly winding its way up the pyramid just beneath the surface.

The notch appearing in the Northeastern edge

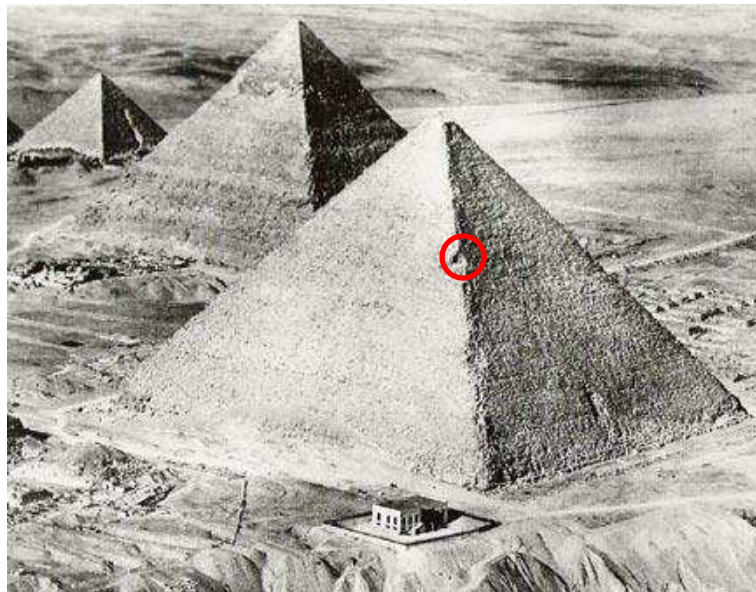

**“Bob’s room”**

The notch explored during the filming of the documentary “Khufu Revealed”

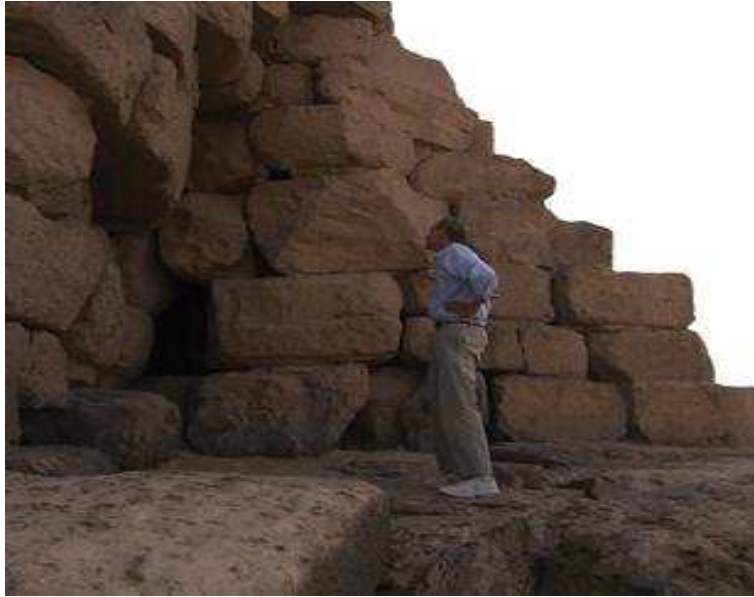

Bob Brier arrives at the notch



Bob Brier discovers an opening



Bob Brier follows the opening into a room



This 3m x 3m room was “built”, meaning that it is a part of the construction, not just a hollow space

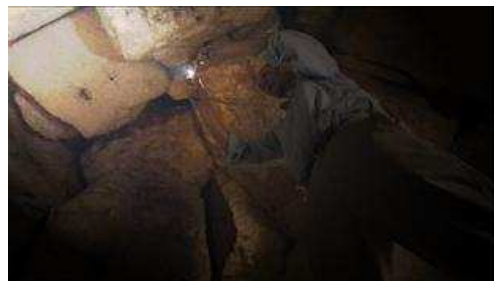

The room is roofed with a cupola

## Virtual reconstruction of “Bob’s room”

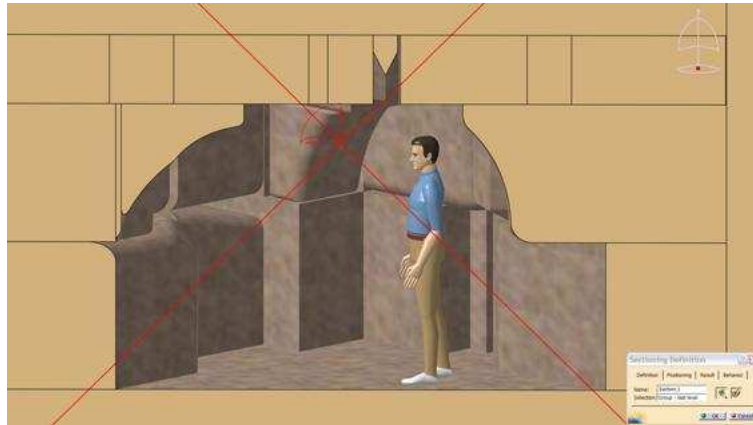

A virtual model of Bob Brier in the reconstruction of “Bob’s room”

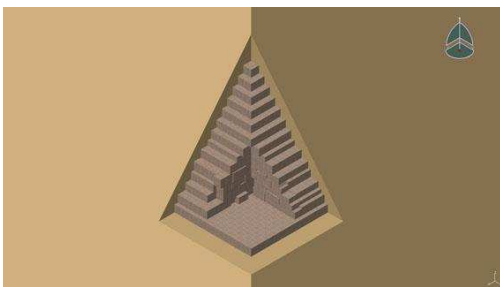

External view of the actual notch

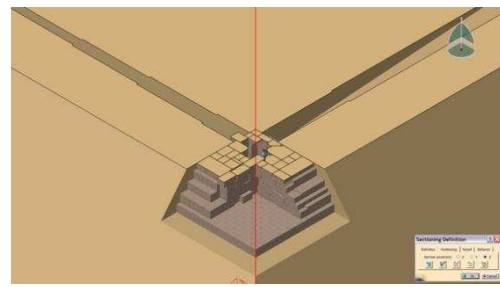

Two ramps converge in a corner of the room

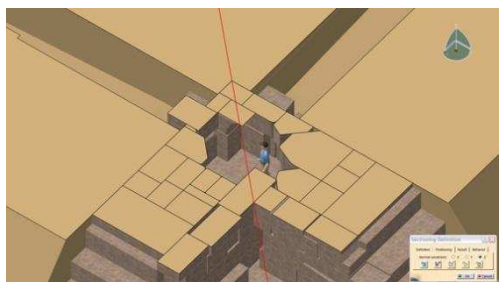

The room shows a 3m x 3m width

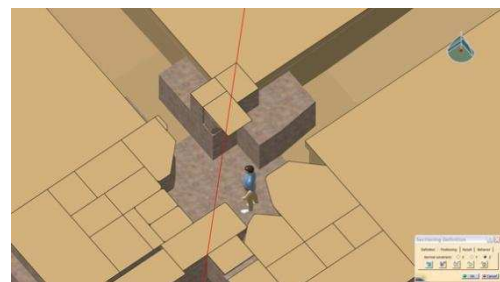

The room is roofed with a cupola built at a later date

## The bi-level internal ramp

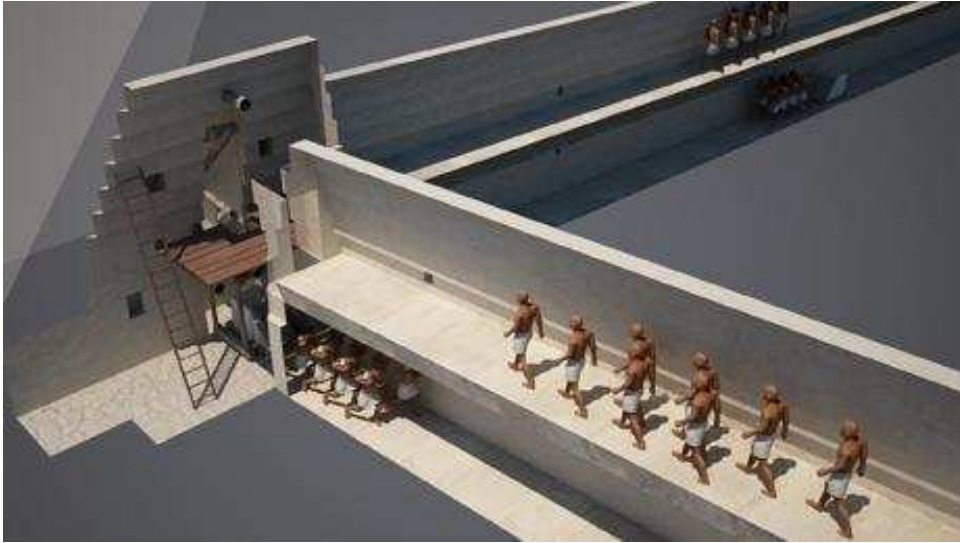

A corridor with a corbelled vault is a well-known technique for the builders of this era

In 2000, a French team conducted a survey of Pharaoh Snefru's pyramid at Meïdum (built around 60 years before Khufu's pyramid). The team discovered several corbelled rooms above the descending corridor and the two small proto-antechambers

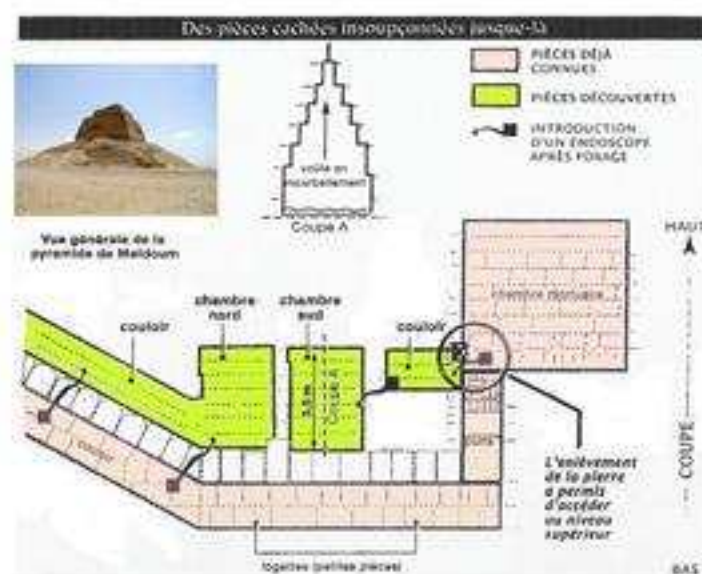



**Situation of the proposed entrance of the internal ramp**

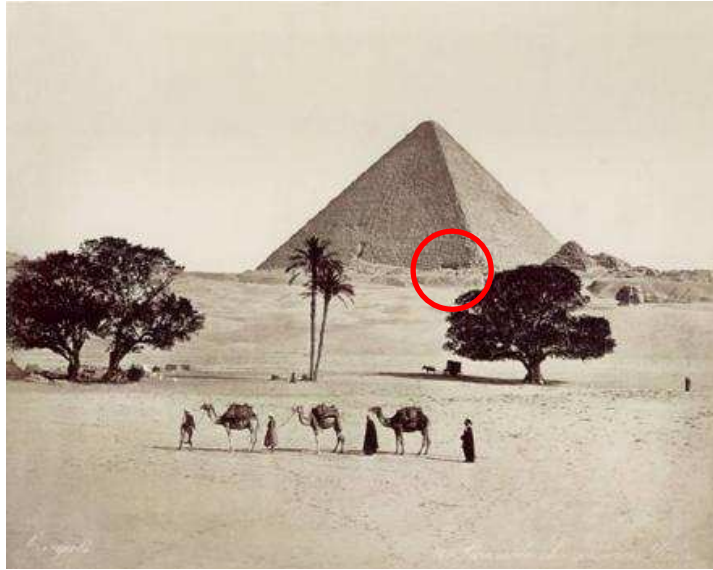

This anomaly at the base of the south face is exactly at the perpendicular of the first “Bob’s room” under the northeastern edge. The first section of the ramp is parallel to the East face. This means that the inset of the anomaly from the Southeast corner places it where we would expect to see the entrance to the first section of the internal ramp and would align the trajectory of the ramp to end where a “Bob’s room” would be at the Northeast corner.

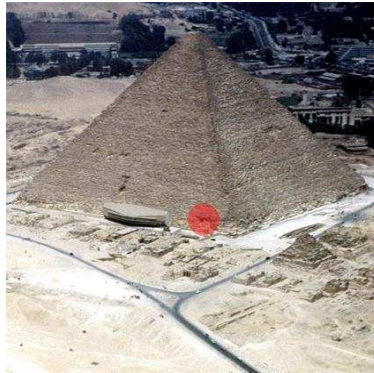

The anomaly is also in alignment with the path coming from the base of the Plateau and port, which also situates it where we would expect to find the entrance to the internal ramp.



The anomaly appears to have been filled in with blocks that look different from the surrounding masonry. This is what we would expect to see if an opening had been later walled-off.

**Attempt to break into the interior ramp at level +43 m**



These four borings occur at the +43m level of the pyramid, parallel to a horizontal section of the proposed internal ramp. This attempt to break into the pyramid at this level could be the result of hammer strikes echoes during the stripping of the facing blocks.

These borings in the South wall had already been noticed several centuries ago and are very discernable during the sound and light evening show.

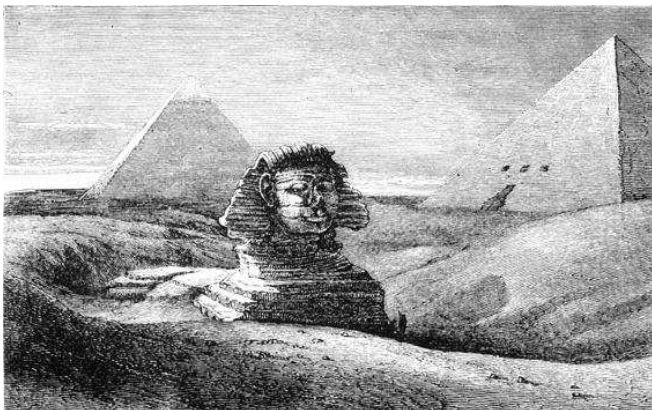

A 17th century engraving



Under a low-angled light

### Phantom lines on the South face



Two horizontal phantom traces are visible on the Southern face of the pyramid. The lower line runs along the +43 m level, the upper line runs at a slant corresponding to the eighth section of the internal ramp, passing just below the mouth of the Southern shaft that extends from the King's Chamber.



The same traces viewed from a different angle.

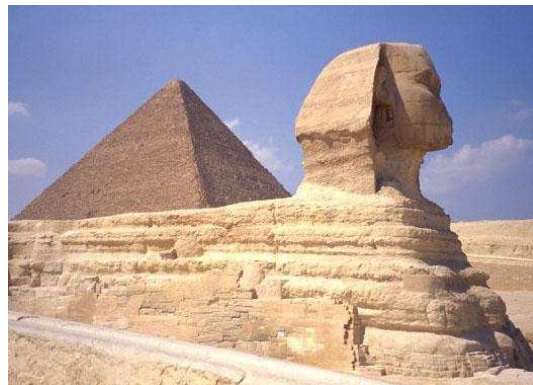

Another view, from a third angle.

## The King's Chamber South shaft

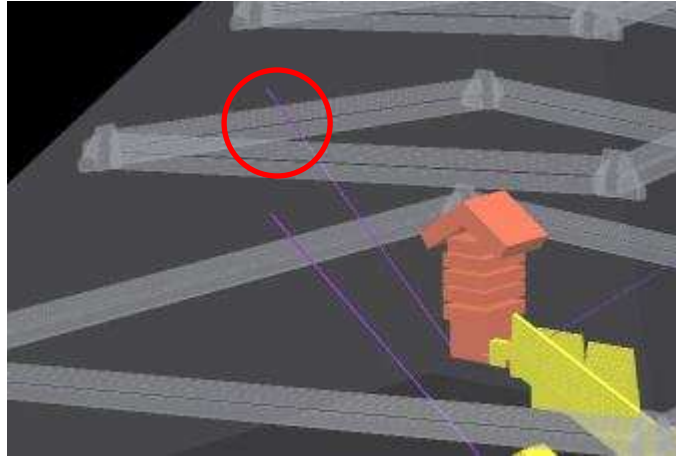

The King's Chamber Southern shaft runs within a few meters of the internal ramp.

Because of how the shaft was built, its construction was halted when it reached an area where the internal ramp was under construction. The stopping point is visible in the shaft at the location of an anomaly dubbed the “Khufu Niche”. This is a place in the shaft where the joint between the upper and lower blocks that comprise the shaft runs perpendicularly on the same alignment on the four faces. Everywhere else the joints are out of line with each other. This suggests a change in the construction at this point, right where a section of the internal ramp would have been constructed. Once the construction of the ramp was completed, work on the shaft resumed.

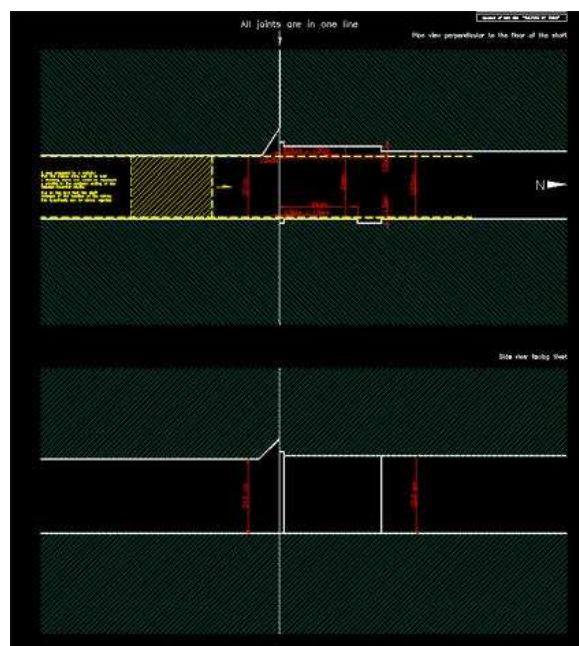

There are four shafts in the pyramid and this anomaly is only found in this shaft.

## **Building from the “inside-out”: A method that stood the test of time**

Niuserre's Solar Temple at Abu Ghurab, built less than a century after Khufu's pyramid.  
A spiraling internal ramp is still visible.

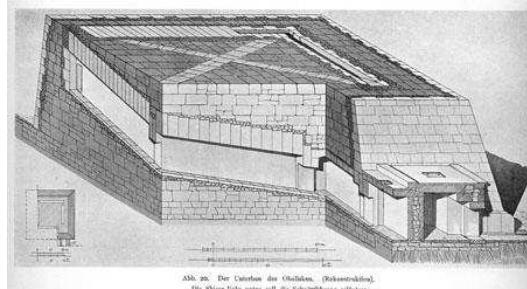

The same methods still in use 45 centuries later: a pile-load test built “inside-out” with sand bags, thanks to an internal ramp. This unusual temporary structure is built to test the resistance of the ground before the construction of a building.



A text published in 1944 by the JEA about pyramids made of bales of rice straw.

### **A Suggestion regarding the Construction of the Pyramids**

WHEN visiting the Société Nationale du Papier at Aboukir near Alexandria recently, I saw several pyramids, 40 to 50 feet high, constructed of bales of rice straw. Rice straw is one of the principal raw materials of this important factory and large amounts have to be stored ready for use in the manufacture of various grades of strawboard. As we passed these pyramids I noticed that there was an entrance, about 4 or 5 feet wide and 6 or 7 high, on one side of each pyramid. I asked the manager, Mr. Donald Parkin, if this was the entrance to a shelter in which the workmen rested, but was told that it was through these entrances that the bales were carried during the construction of the pyramids, which were built from the inside. I therefore made a closer examination and found that what looked like a small chamber was a sloping passage or tunnel leading right into the interior of the pyramid. Apparently, in constructing the base of the pyramid, an opening is left in one side and a sloping passage is made from this opening nearly to the other side of the pyramid. All the bales are carried up this internal ramp (which had a slope of about 20°) and the building of the pyramid is continued from the inside. When the structure has risen about 6 or 7 feet above the floor of the passage, a few lengths of timber or iron are placed across the passage, which is then roofed in with the bales which will form part of the next layer. The result is a sloping tunnel through the lower part of the pyramid. The passage is then made to turn on itself at an acute angle till the next layer of the pyramid has been built and is again roofed in. This goes on till the top of the pyramid is reached, all the construction having been carried out by taking the bales up this sloping, zigzag tunnel, which is like an internal staircase without any steps. Mr. Parkin informed me that this was the local Egyptian labourers' own method of construction; they had been told merely to stack the bales. Have they unwittingly adopted some hereditary, traditional method of construction, handed down through the centuries from the building of the Pyramids, and does this throw any light on one, at least, of the methods by which those enormous monuments were built? It will be seen that the method is much more economical in labour and materials than one based on external ramps, which must have reached enormous dimensions. I shall be interested to learn if this suggestion is new to Egyptian archaeologists.

J. E. G. HARRIS

# 2

## Clues about the internal distribution

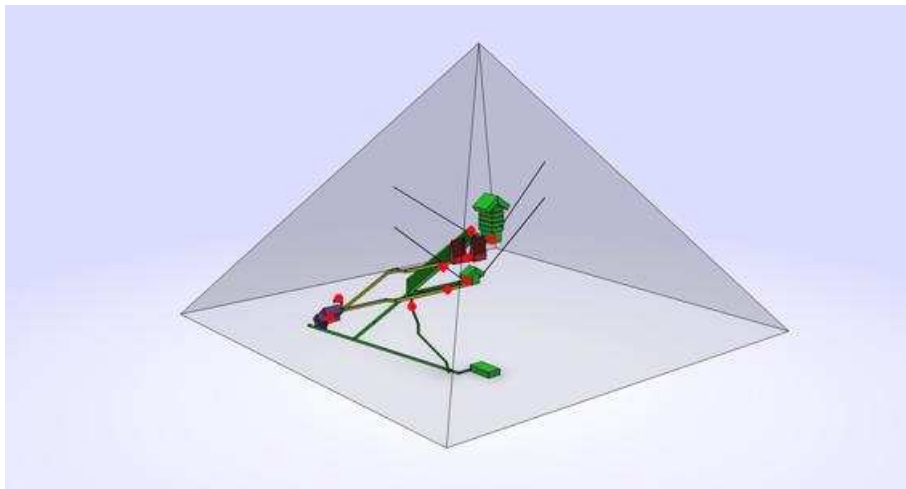

**The Grand Gallery and the counterweight**



Original V shaped step



Step reshaped during the 20th century



Scratches parallel to the lateral benches



Brown traces on the lateral benches

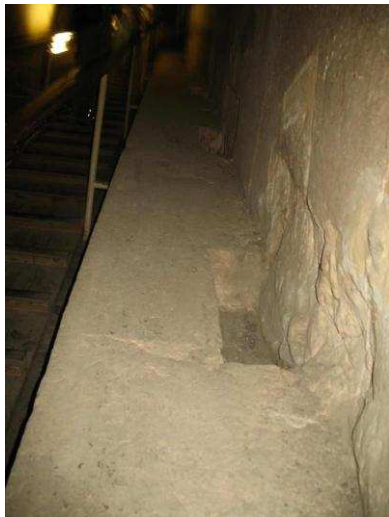

Regularly spaced holes in the lateral benches



Holes in the V shaped step



A groove on both sides of the Grand Gallery all along the third corbelling.



The roofing technique of the Grand Gallery is slightly different from usual corbelling. Some of the slabs were set in place at a later date (pictured here, the roof of the pit of the Khufu's Solar Boat).



## The Grand Gallery and the well

The purpose of the so-called “well shaft” situated in the Western wall at the lower end of the Grand Gallery has generated much speculation. One theory, in conjunction with the hypothetical case of a funeral procession which followed the ascending corridor and Grand Gallery, is that the well-shaft was used as an exit for the builders who carried out the maneuvers to put in place the blocks used to plug the ascending corridor once the interment was concluded. This is impossible for two reasons:

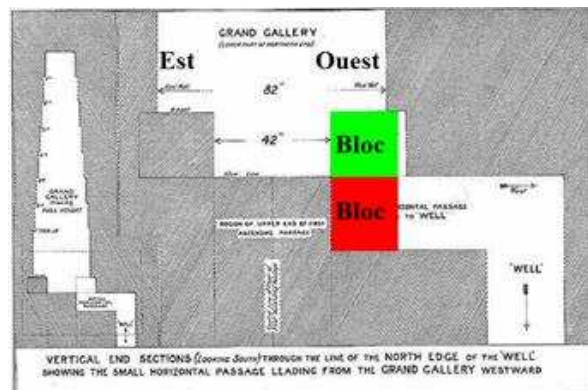
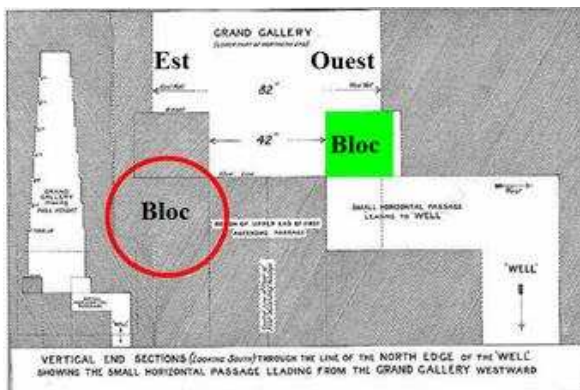

In order to set the green block in place and properly seal the well, one must set in place a supporting block as shown in the red circle (left).

If the red block is set in place first, it becomes impossible to position the green block from the well.

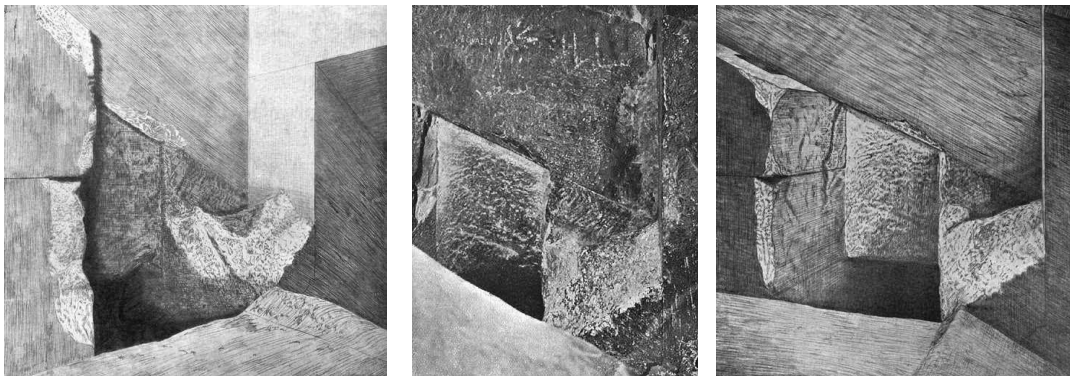

The evidence left by the robbers as they broke in indicates that the well-shaft was perfectly sealed from the Grand Gallery before being re-opened by the intruders. Only one vertical block was used to build this part of the bench in the Grand Gallery, as evidenced by the two vertical joints. In the image on the left, one can see a small vertical block, 13cm wide, in the first row. This detail is a result of the construction technique of the well-shaft.

**The pyramid's conception based on grids**

For the volume: a horizontal plane and a frontal plane with a 20-square-cubit primary grid centered on the North/South axis and the East/West axis.

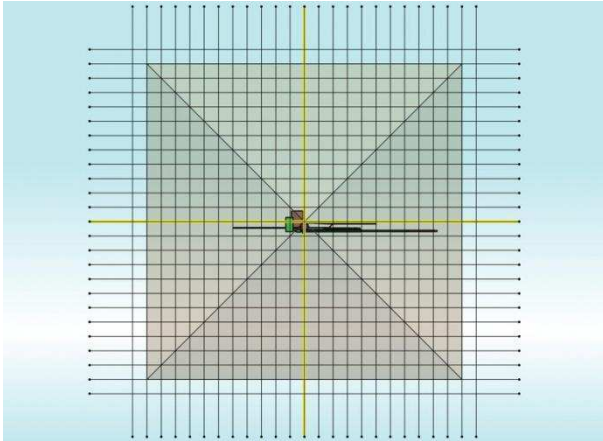

22 units on the horizontal plane, so 11 units on each side of each axis

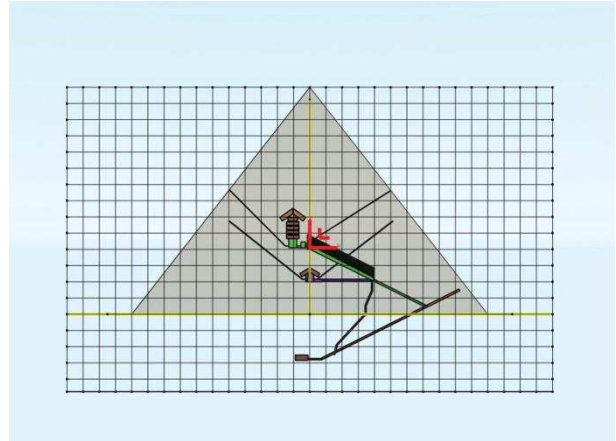

14 units on the vertical plane for a base of 11 units (22/2) ; that gives a 14/11 ratio, called *Seked* by the Egyptians

As for the inner construction works, they were conceived based on a secondary one-cubit grid traced within the primary grid, limited to the area where they would be built.

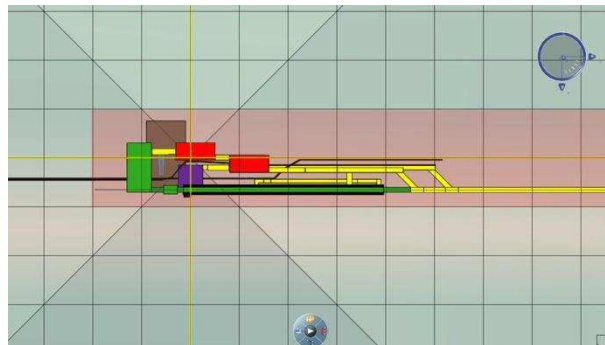

The primary grid (above) with, in the red area, a secondary grid (below)

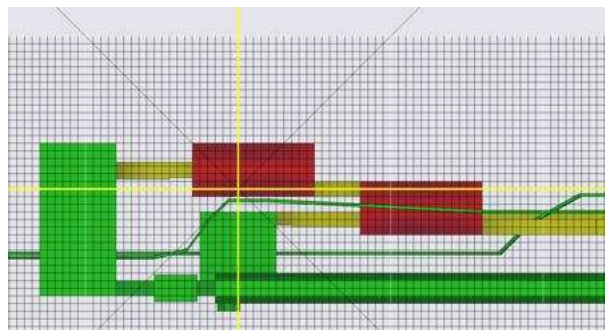

### Snefru's legacy with the Red Pyramid: two antechambers

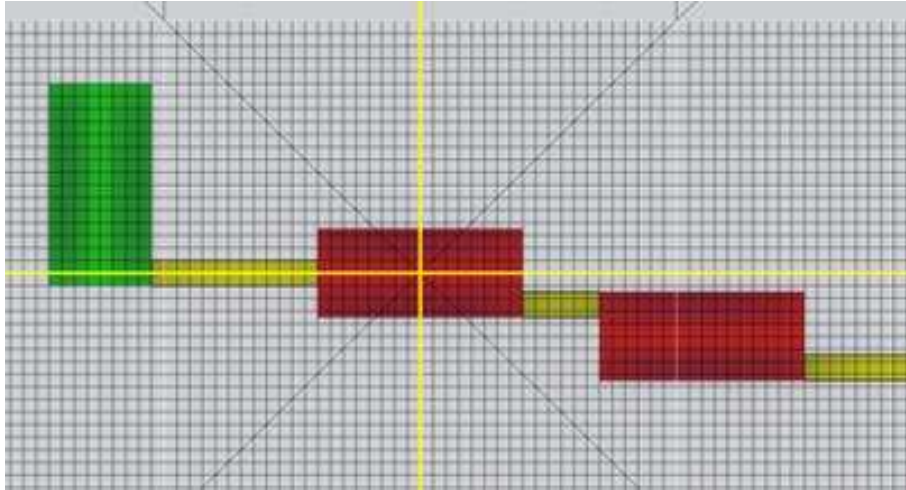

The two antechambers (red) and the funerary chamber (green) in the Red Pyramid

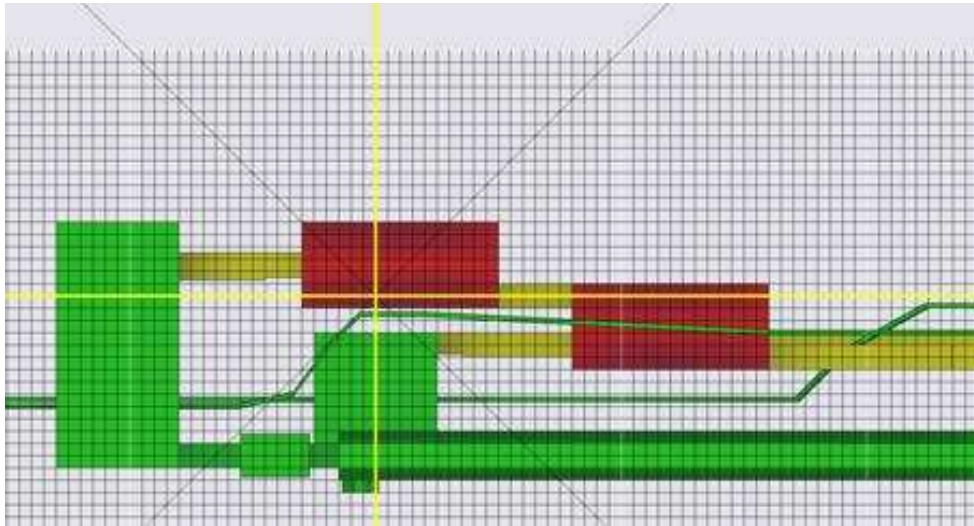

The two antechambers and the funerary chamber in Khufu's pyramid: a perfect "copy and paste".

All of the internal architecture of Khufu's pyramid was planned around this central configuration of two antechambers and a burial chamber. All other passages, chambers, and shafts were designed and built to accommodate the precise location of these three chambers.

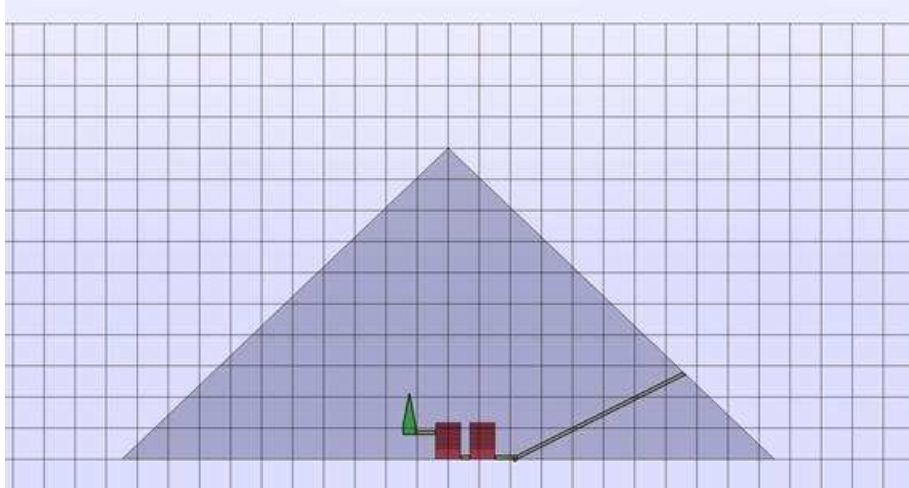

The funerary apartments in the Red pyramid

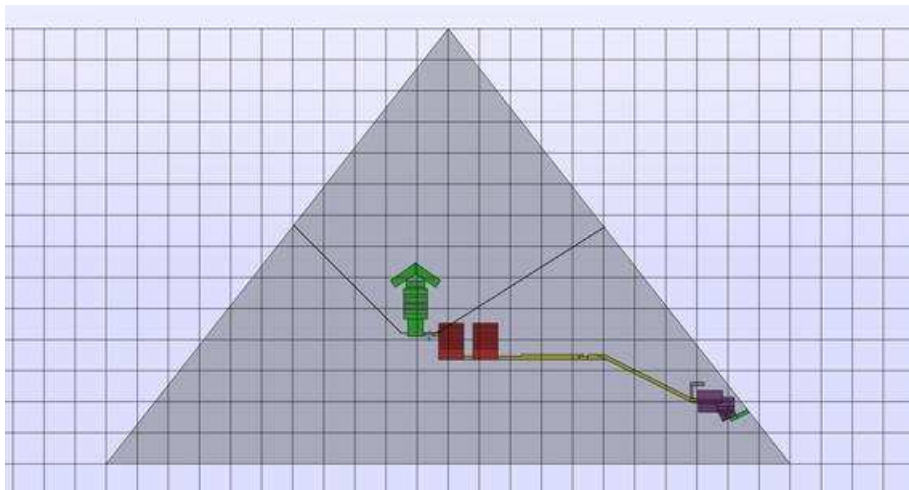

The funerary apartments in Khufu's pyramid

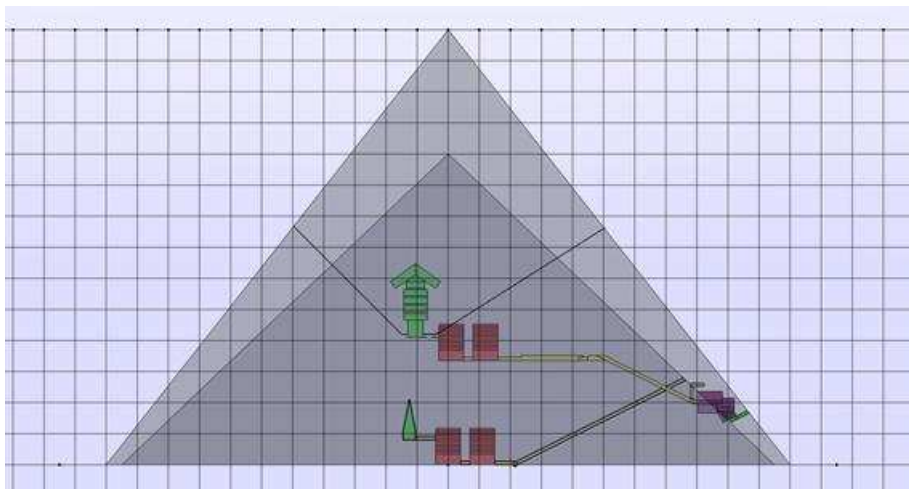

The funerary architecture legacy left by King Snefru to his son Khufu.

**The layout of the blocks in the North wall of the King's Chamber**



Hidden portico (in pink left) and the entrance block (red arrow right); the blocks in yellow (left) fill the space above the entrance, but do not rest on the entrance block. They are supported by the surrounding blocks instead. This entrance will hereafter be referred to as the “second entrance”, with the first entrance being the one we are all familiar with—the one that enters from porticulis chamber.

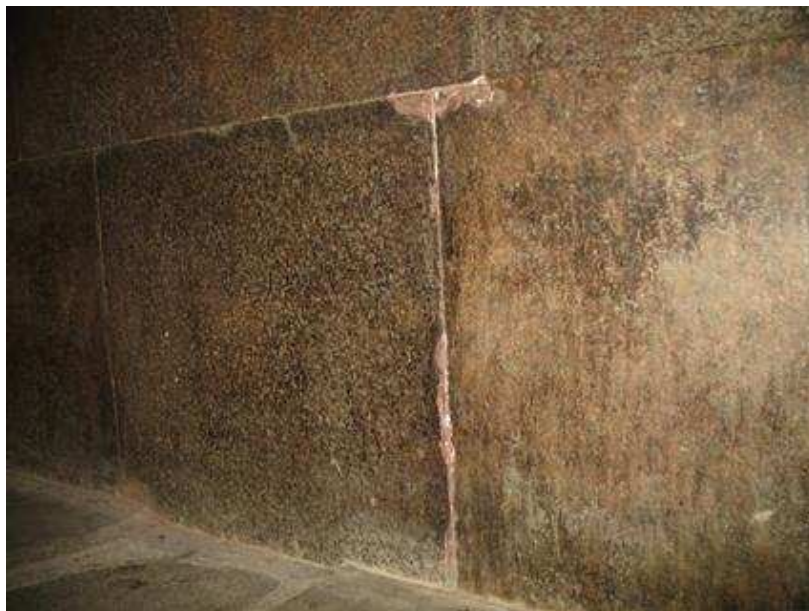

A wide joint is seen on the right of the block sealing the second entrance. A closer look shows that this block is not in the same alignment as the other blocks of the North wall.

### The cracks in the blocks of the North wall of the King's Chamber

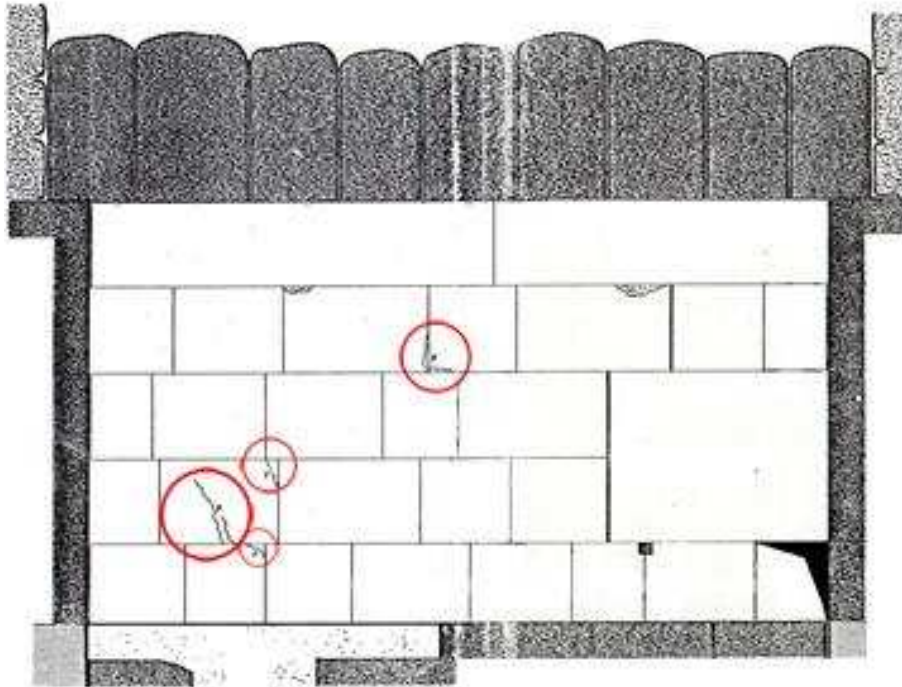

The North wall is perfectly resting on its foundations and hasn't moved in 45 centuries; only a few very thin cracks appear on four of the blocks: the block sealing the second entrance, the block immediately above it, and two blocks in the upper part of the portico. The width and positioning of the block above the second entrance allowed it to serve as a lintel, indicating that the block that currently rests under it does not serve a supportive function—its sole purpose was to seal the second entrance. It was not intended to support the weight above it. The builders left some clearance for the positioning of the sealing block. When Al-Mamoun's men dug a deep hole at the base of the sealing block while looking for treasure, it slightly weakened the foundation beneath the second entrance, causing the cracks as the structure resettled.

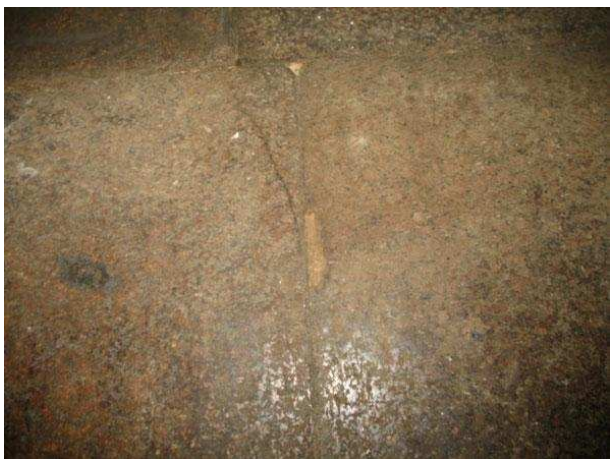

Cracks on the upper part of the lintel



Cracks on the lower part of the lintel

### The forgotten block in the King's Chamber



The granite block on the right was still in the King's Chamber in 1998, before some restoration work was conducted. This block has since disappeared.



This block was perfectly cut: it was part of the North wall of the King's Chamber and sealed the entrance from the portcullis chamber. It was partially broken and pushed inside the King's chamber by Al-Mamoun's men when they broke into the pyramid around year 820, seeking treasure. The block stood in the chamber for nearly twelve centuries, although no one ever asked about its presence.

### The hole dug in the King's Chamber floor

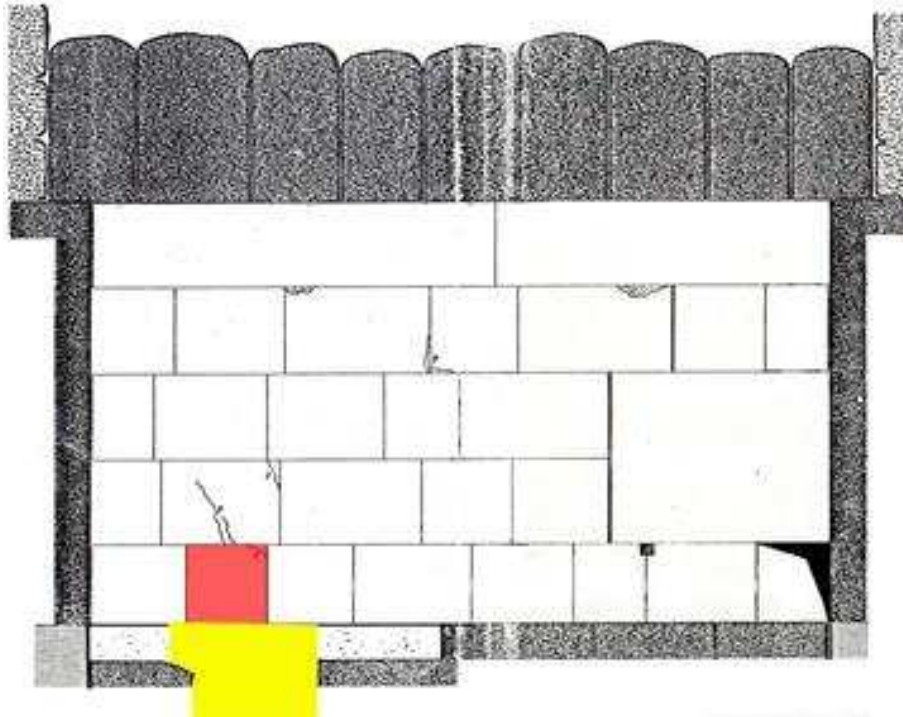

Al-Mamoun's men dug a deep hole in the floor of the King's Chamber (in yellow at the base of the wall) exactly vertical to the second entrance block (in red). What drew the treasure hunters to this particular spot? They must have perceived some anomaly that suggested that there was something there to be found.



The precision with which this granite block was cut is noteworthy and suggests it served an important function. From the Ninth Century until its removal in 1998 (to who knows where?) the block stood as a silent piece of the puzzle. For a while it was used to hold in place the metal grate that blocked entrance to the hole in the floor. One can only wonder if this important piece of architectural evidence serves an equally mundane function now.



### The microgravimetry measurements carried out in the King's Chamber

In 1986, a microgravimetry survey was carried out by a team sponsored by the EDF Foundation. The team made a detailed analysis of the King's Chamber and the relieving chambers above it, searching for low-density anomalies that suggested a hidden chamber. The team had expected to find evidence of such a chamber in the North area behind the upper part of the relieving chamber, and had even gone so far as to simulate how such an anomaly would appear.

But the survey failed to produce the expected results. Instead of indicators of a hollow space north of the upper part of the relieving chamber, the team isolated a low-density area in the lower Northwestern corner of the North wall—precisely in the area of the proposed second entrance.

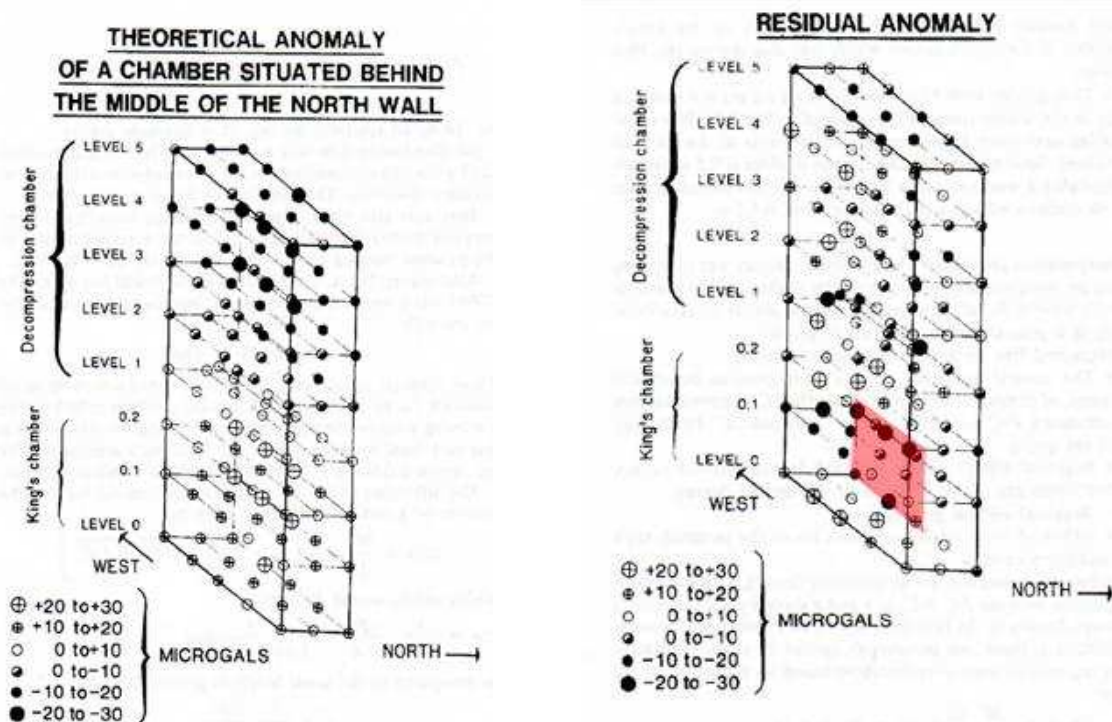

Figure 5.

Simulation before the survey

Results of the survey

Separated by nearly twelve centuries, and using very different methods of observation, the microgravimetry team had been led to the same spot as Al-Mamoun's men. As the above images from the study show, the low-density anomaly (in pink) corresponds exactly with the location of the theoretical second entrance and the room that would house the closure mechanism that would maneuver its sealing block into place.

**The closure system of the second entrance**

The room housing the closure system, which would have been used to position the sealing block in the corridor linking the second antechamber to the King's Chamber, should stand directly on the other side of the North wall where the anomaly was detected.

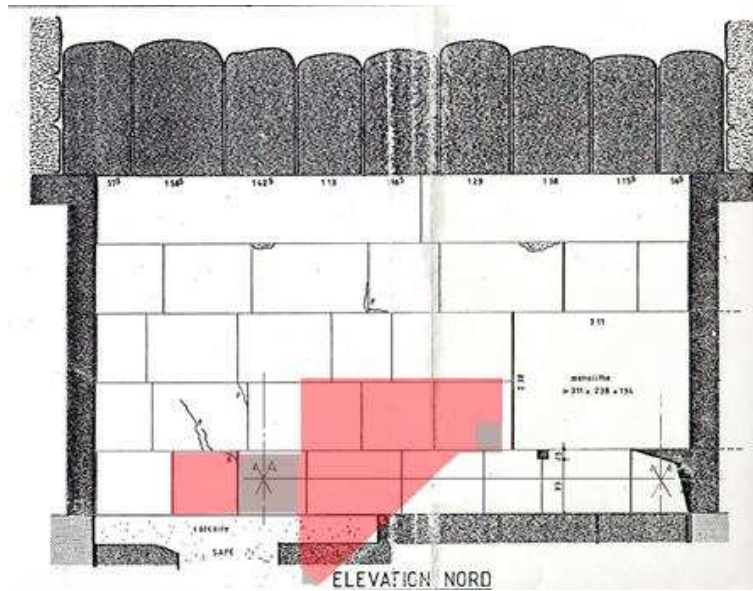

This closure system is a direct evolution from a portcullis system used in the Bent pyramid.

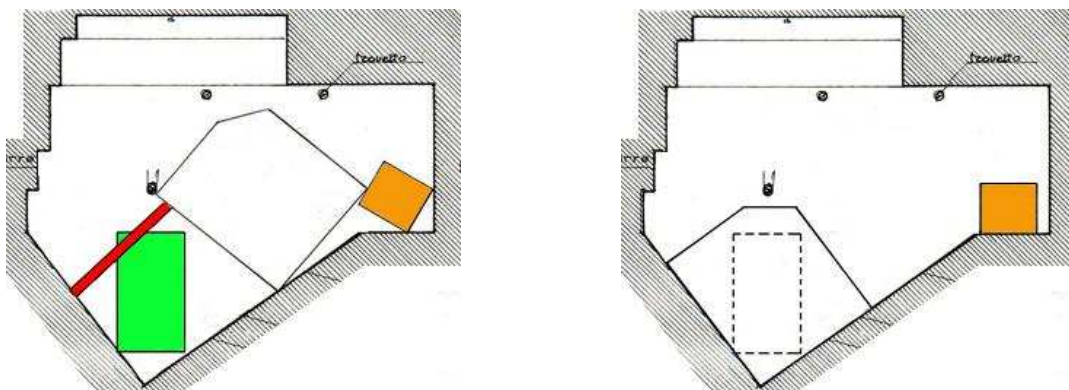

This closure system was already used in the Red pyramid between the Second antechamber and the funeral chamber.



### The King's Chamber North shaft

The starting point of the Northern shaft in the King's Chamber was determined by the location of two elements of the pyramid's internal architecture that were already designed: the portcullis chamber to its right and the room housing the second entrance closure system to its left.

The shaft could have started straight from the center of the North wall and could have avoided a very tortuous path. But in that case, it would have crossed the room with the closing system.

Since we know that the shaft twists to avoid a known structure—the Grand Gallery—we may infer that other changes of trajectory were incorporated to avoid other internal structures, and one of these unaccounted-for twists occurs where the accumulation of evidence suggests the housing compartment for the second entrance sealing mechanism would be. Another change of course occurs where the corbelling of the second antechamber should be.

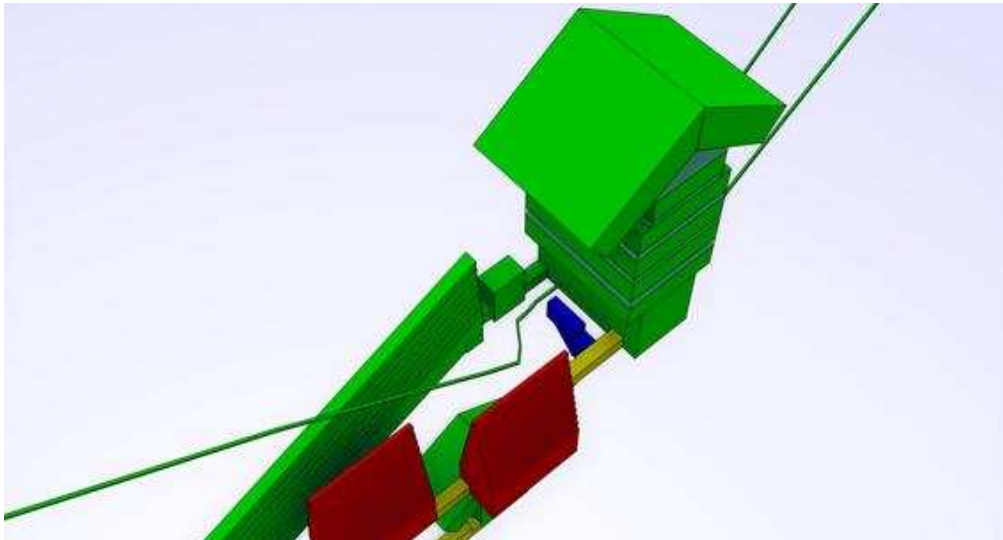

### The second corridor leading to the Queen's Chamber

A second corridor leading to the Queen's Chamber was detected by a team from Waseda University (Japan). Two radar surveys were carried out in 1987 and both results were identical: There should be a corridor (1m x 1.80m x 30m) starting in the Northwestern corner of the North wall (in the same corner as the second entrance to the King's Chamber)

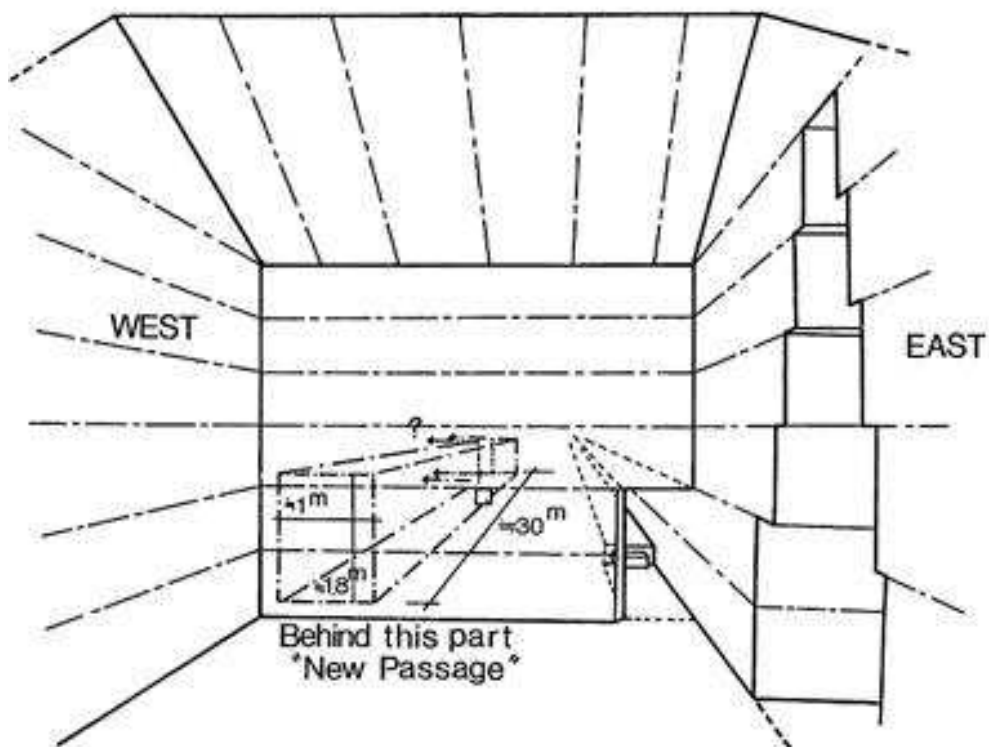

Fig.38 North wall of Queen's Chamber

As of this date, this archaeological evidence remains filed away in a drawer, its importance seemingly unapparent to those who collected it.

### **Position and path of the North shaft of the Queen's Chamber**

The size of the Queen's Chamber, the position of the North shaft and its path through the masonry were greatly influenced by the presence of this second corridor:

1. The designers had to navigate the North shaft between the two corridors.
2. Due to the thickness of the walls of these two corridors, the designers added one cubit to the length of the Queen's Chamber. Both the King's and Queen's Chambers are 10 cubits wide, but the Queen's Chamber is just over half (eleven cubits) the length of the King's Chamber (twenty cubits). Why the odd number? Why not an even 10 x 10 cubits, exactly half the length of the King's Chamber, if not for structural purposes? The extra cubit allows for the setting of the shaft between both corridors walls.
3. A little further up the shaft makes another unusual change of course, shifting about nine cubits to the West to avoid the second corridor leading to the King's Chamber, just north of the two antechambers. A shift of just one or two cubits would have been sufficient to avoid the Grand Gallery; so again, a radical change in the course of a shaft implies the existence of something the designers were trying to dodge, in this case the corridor leading into the antechambers.

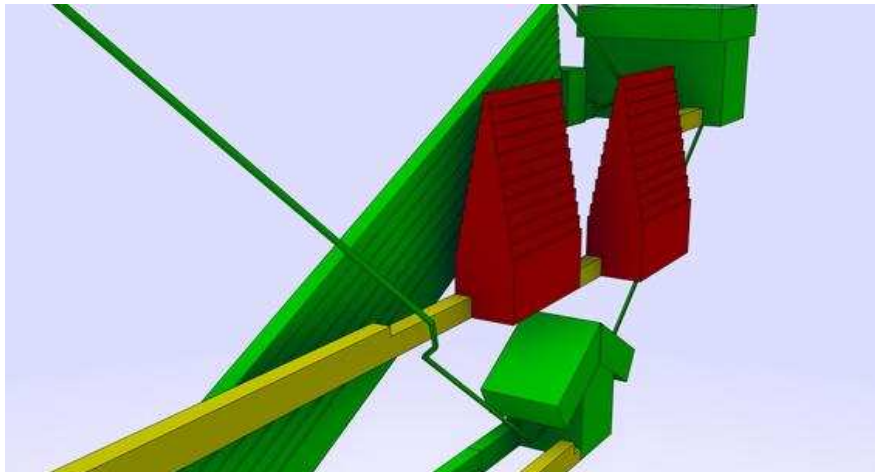

A view from above

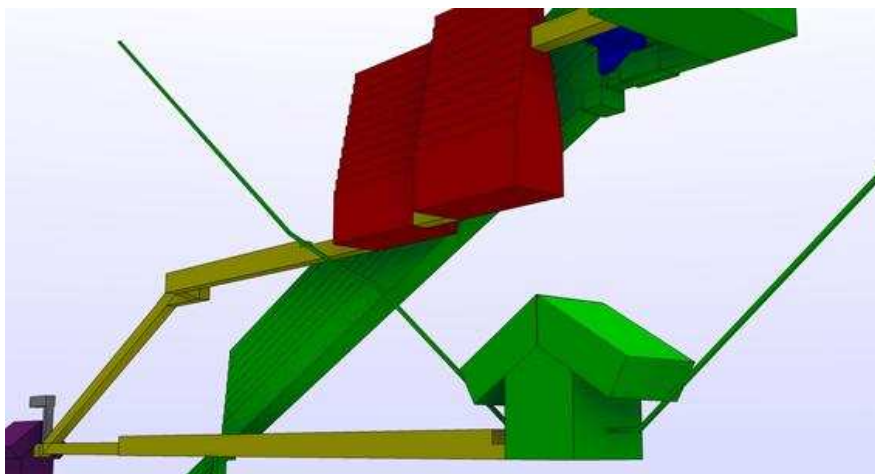

A view from below

## The two antechambers and the microgravimetry survey

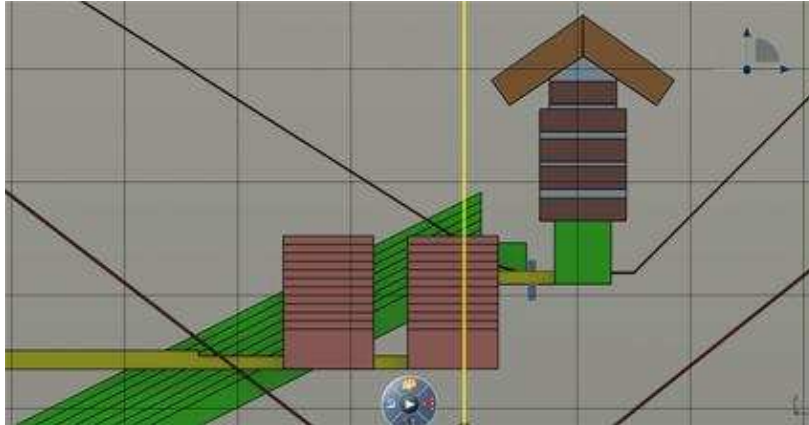

Microgravimetry survey - EDF Foundation - 1986

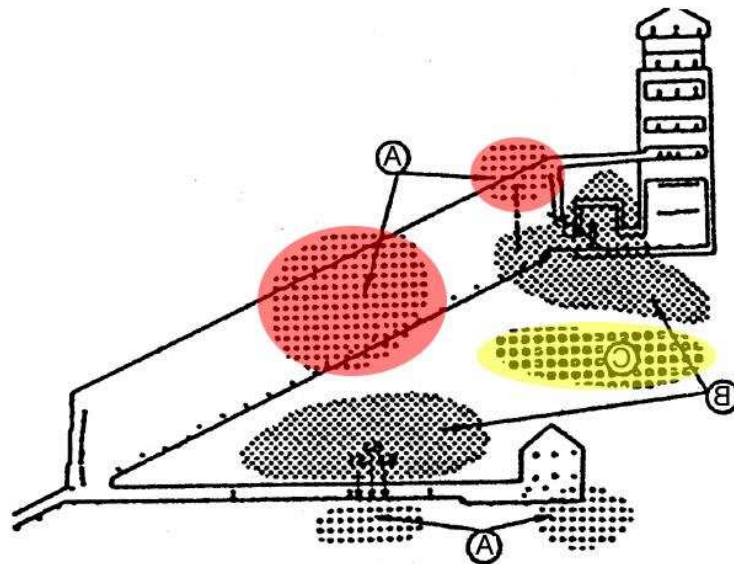

Areas marked A are areas of low-density:

Two small anomalies, one below the horizontal corridor leading to the Queen's Chamber, one below the same chamber

One small anomaly on top of the Grand Gallery (in red) which could correspond to the opening through which the ropes for the counterweight system ran

One large anomaly very close to the Grand Gallery (in red)

Areas marked B are areas of high-density:

Reinforced masonry beneath the Grand Gallery, beneath the King's Chamber, and on its North side

The area marked in C (in yellow) is an area of possible low-density:

Observations in this area could be linked to the nearby area B and by the lack of microgravimetry measurements on one part of the Northwestern edge.

### The reason for the relieving chambers

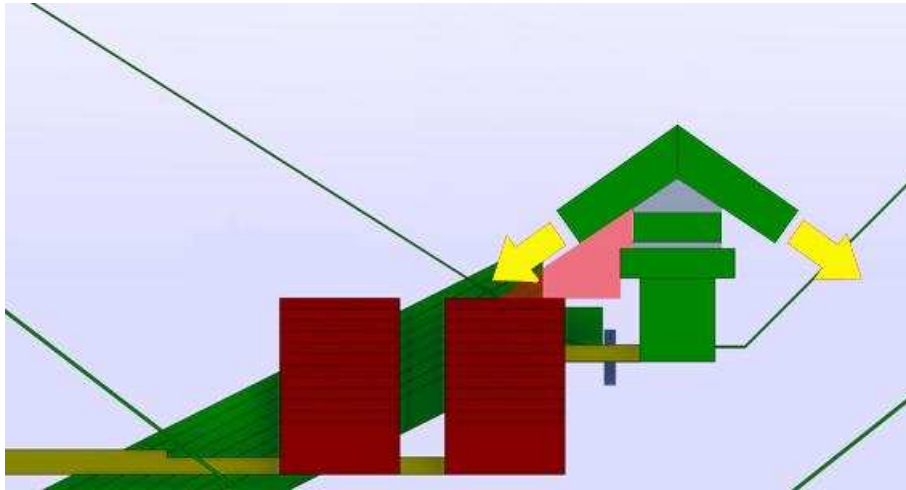

If the limestone gable roof bearing the load above the King's Chamber would have been built on top of the first ceiling, the oblique load transferred by the North side would have crushed the antechambers. The corbelled vaults of these rooms were only designed to bear vertical loads.

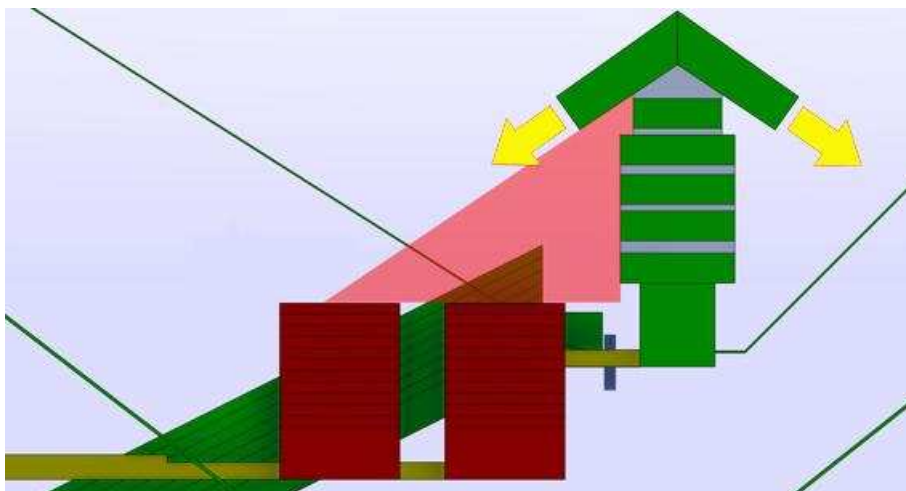

To avoid this problem, the Egyptians built this strange structure, made of five successive ceilings and a limestone gable roof. Doing so, the roof was pushed very high above the first ceiling. The oblique load of the North side of the roof is transferred in the masonry well above the antechambers.

The counterweight system running in the Grand Gallery was needed for the construction of the first ceiling. The Egyptians didn't hesitate to build this structure in order to assure the success of this grandiose project: a King's Chamber with a flat ceiling in the core of the pyramid.

The pyramid of Khufu deserves its ranking as the 7th Wonder of the World.

**The rafters of above the entrance**

The limestone rafters above the original entrance (at the center of the photo above) are disproportionately large for a simple roof for the descending corridor. Moreover, they are set much too high above the descending corridor.

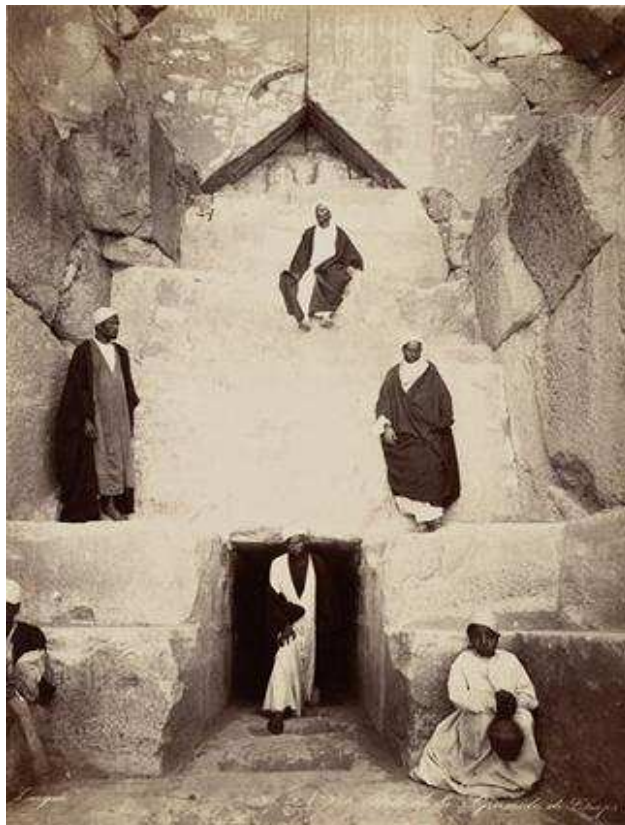

The men standing in the photo give a good idea about the distance between the descending corridor and the rafters.



By measuring on site the oblique existing abutments, one can notice that 6 pairs of rafters are missing for the lower row and 3 are missing for the upper row. The lower series covered a void, while the upper series partly overlapped the lower roof.

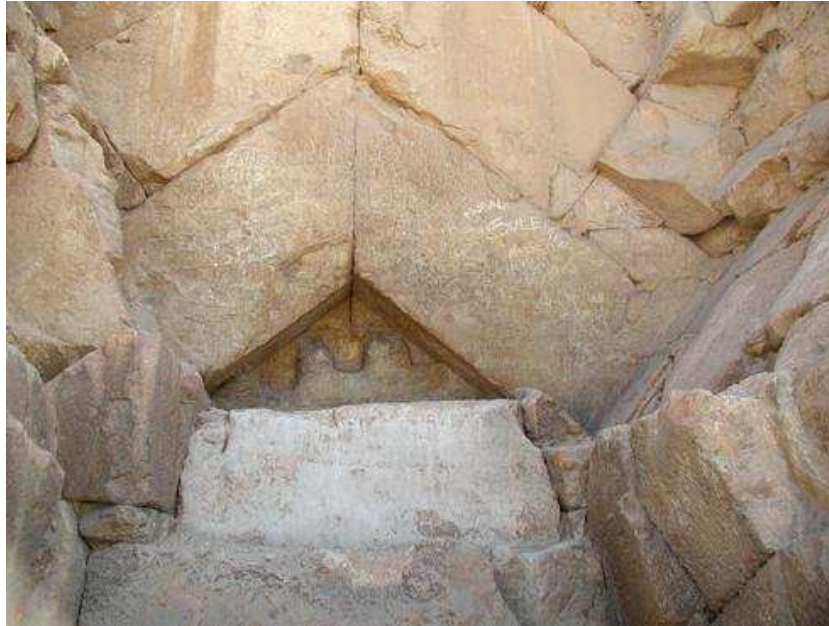

Obviously, the fluted block inserted below the first row of rafters was pushed from the inside, as indicated by traces of mortar jutting out below the rafter on the right. Ahead of this block, the limestone floor was carefully repointed with plaster and polished. Additionally, this block doesn't fill the whole opening, a 40cm high triangular void was filled with a masonry perfectly centered with the axis of the gable roof.

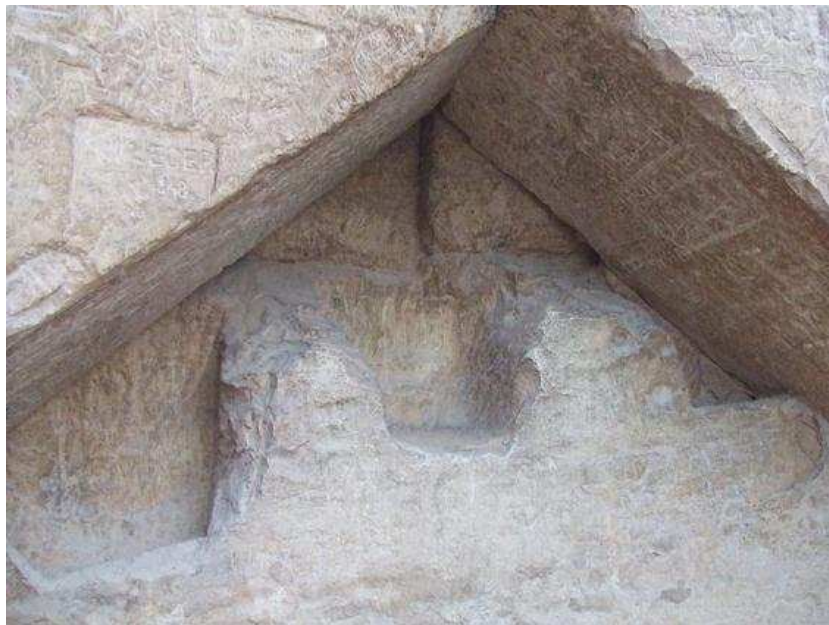

**The upper gable roof above the entrance was detected by microgravimetry**

A detail went unnoticed in the image of the spiral anomaly detected by microgravimetry: there is an area of very high density under the north face exactly corresponding with the prolongation of the rafters above the entrance. This area is shifted to the East of the North/South axis, placing it in precise alignment with the already known corridors of the pyramid. Moreover, this over-density stops just at the vertical of the second section of the proposed internal ramp.

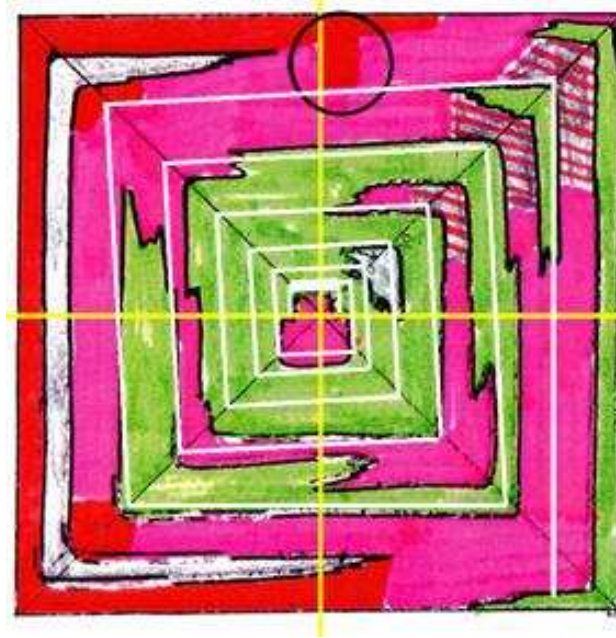

Around ten pairs of rafters should be embedded in the masonry behind the upper series above the entrance. These pairs of rafters should cover a second void.



### The model of the connecting well behind the entrance

After the funerals, and after having sealed the pyramid in several places (Chamber, antechamber, corridor and entrance room), the workers had to leave the monument. It is supposed that they left the funerary apartments through a well, built behind the second room of the entrance, connecting the second ascending corridor to the internal ramp. During the conception phase, the designers did a model of the well in the so-called "trial passage" dug at around fifty meters East of the pyramid.

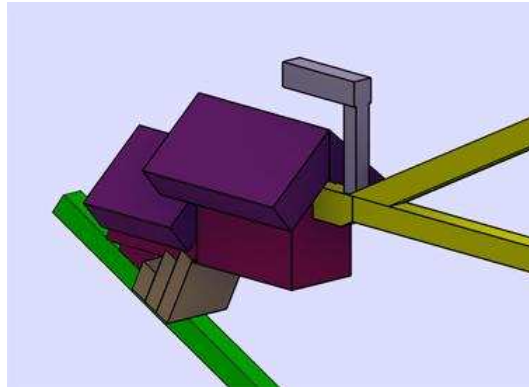

The vertical well (in grey) was simulated on the "trial passage". By making a model, the designers were able to understand its interconnection with the horizontal corridor and the ascending corridor.

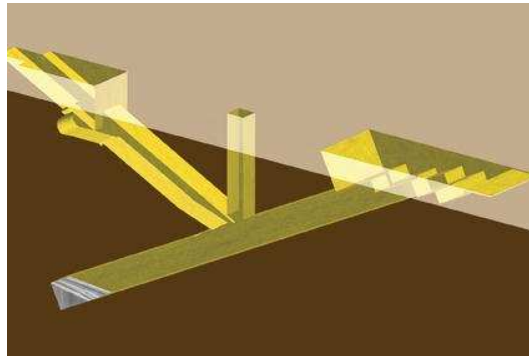

The well at the junction of the corridors in the model doesn't appear in the present corridors inside the pyramid, although it has not been simulated for nothing. Its dimensions fit very well for a connexion with the internal ramp.

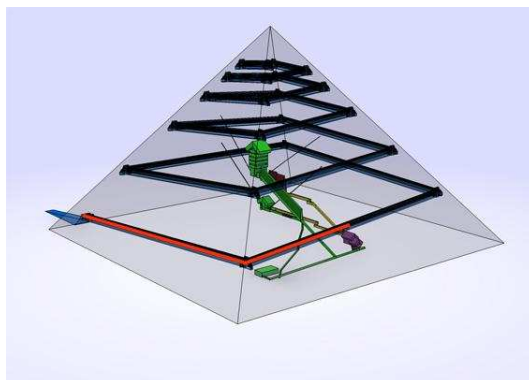

The well links the second entrance to the internal ramp, allowing the passage of the workers. The only task remaining is the sealing of the entrance of this ramp at ground level on the South face.

**The Turah limestone of the facing was set already cut and polished**

During the construction of smooth-sided pyramids, the facing blocks were set in place first, layer after layer, having already been cut and polished at the quarry; the pyramid was completed while being raised.

Bent Pyramid at Dahshur :



Many patches on the facing blocks, some of these could not have been inserted after the setting in place of the blocks in the row above them.

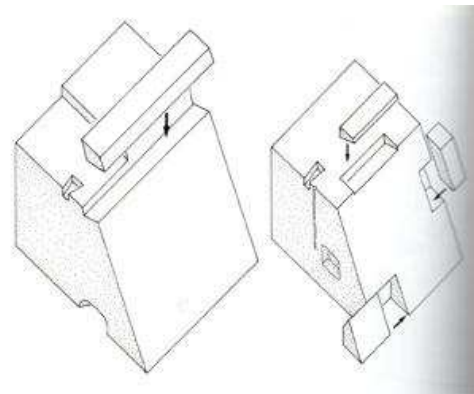
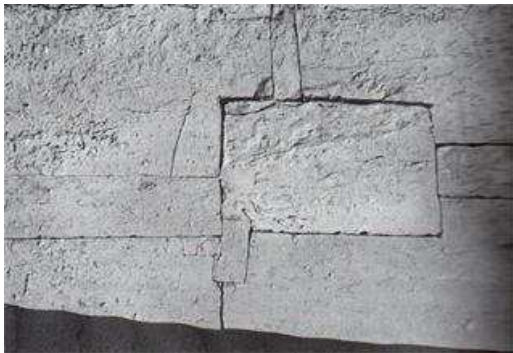

Examples of "repair patches" described by Egyptologist Dieter Arnold in his book "Building in Egypt"

# 3

## Clues about the external ground installations



**The ramp from the port for the construction site of Khufu's pyramid**



General view with the ramp linking the Lower Temple of Khafre and his pyramid ; in the foreground, the Sphinx's Temple, and behind, the Sphinx. The length between the entrance of the Lower Temple and the pyramid is about 650m for a difference of level of 55m. The average slope is around 8,5%.

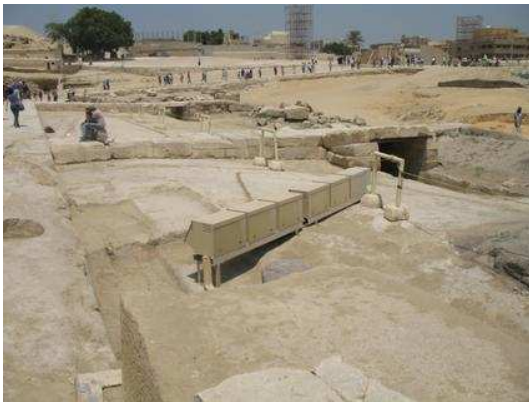

Left, the port of Khafre, right, the quays.



View from the exit of the Lower Temple. Khafre's pyramid is in the background.

Centered at half-way of the ramp and for about 250m, there is a slight depression beneath the south part of the causeway. This section had to be filled with huge limestone blocks. The causeway had to be "built" for this precise area.



Left, a view towards the Lower Temple. Right, a view towards Khafre's pyramid. The width of the causeway can clearly be determined for the whole area: the main central lane, slightly thicker, is 19 to 20 cubits wide, and both side lanes, North and South, are 13 cubits wide each. The total width comes for 45 to 46 cubits (23.50m to 24m), which is twice the width of Khufu's causeway.



Only one layer of blocks was required to fill this slight depression. Passers-by give the scale of the blocks. At a later date, the bedrock was even dug beneath the causeway.



The Royal Causeway reaches the Upper Temple in the South part of the East face with an angle of 80°. Thus, the entrance is not centered on the East/West axis (in order to reach this shifted entrance, the causeway had to bent slightly at 50 meters from the entrance).

## The Lower and Upper Temples of Khafre and the Sphinx Temple

The Royal Causeway does not enter the temples in a logical manner but had to be adapted to an existing situation linked to the presence of the first ramp for Khufu's construction site, the ramp linking the port to the bottom of the exterior ramp. It does not enter along the centre-lines of the temples but to the sides of the faces. Moreover, the Causeway starts from the middle of the Lower Temple, pointing out that the Temple was built astride on an existing ramp. In addition, the architecture is solid and heavy, the void/solid ratio distinctly favouring solid. We could qualify it as "solid" architecture.

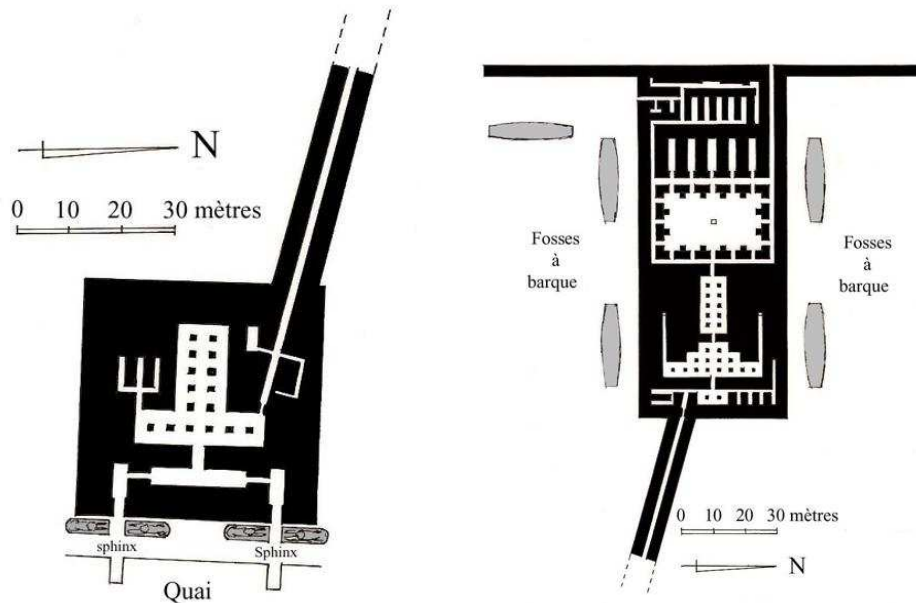

Entrance to the Upper Temple of Khufu: although the Royal Causeway is at an angle, it joins the Upper Temple on the (West-East) axis aligning it with the pyramid.

The interior architecture is very airy: this is "void" architecture and pre-dates the Temples of Khafre.

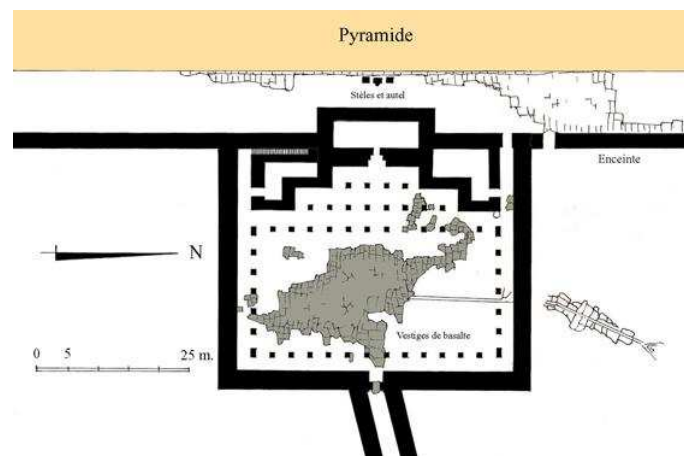



Entrance to the Upper Temple of Menkaure : the Royal Causeway is straight and enters the Upper Temple perpendicularly, in line with the East/West axis between it and the pyramid.  
 The architecture is solid and heavy: this is "solid" architecture, as seen in the Temples of Khafre, showing it was built after them.

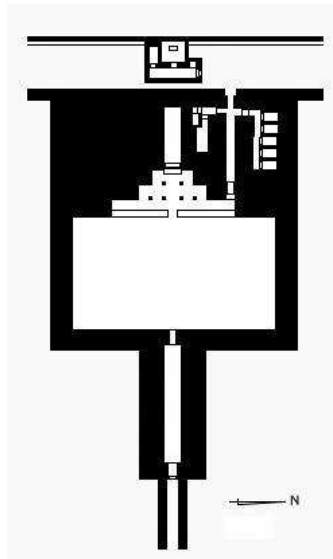

Finally, the Temple of the Sphinx and the Lower Temple of Khafre. From the above observations, we can clearly see that the Temple of the Sphinx was constructed before that of Khafre; the Temple of the Sphinx has the airy architecture of the Upper Temple of Khufu (below).

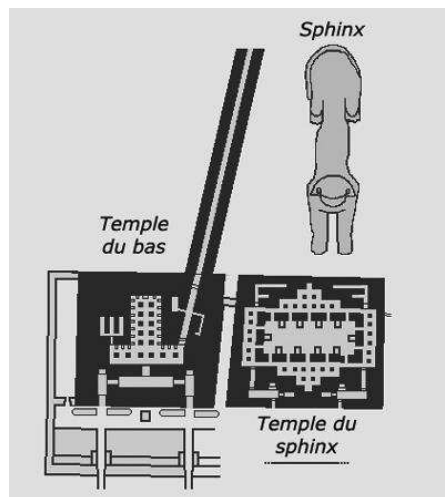

**The trench beneath Khafre's pyramid in continuation of the ramp from the port**

The slideway for the second counterweight system must have been excavated in the bedrock of the upper part of this causeway and along its extrapolation. It must have looked like two trenches known from this period and still visible today:



The Great Excavation at Zayet El-Ahryan



The trench of the Pyramid of Djedefre at Abu Rawash

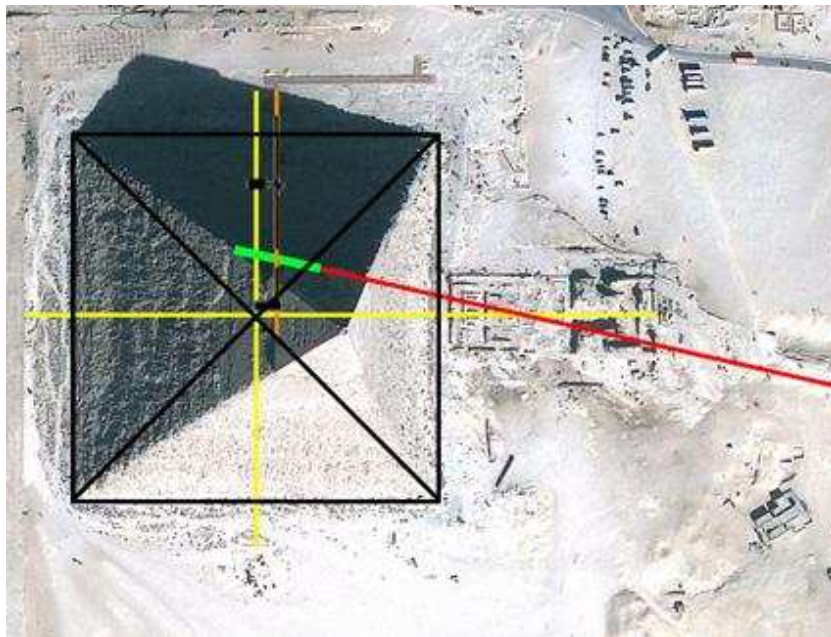

The trench must therefore have left traces beneath the pyramid of Khafre

Actually, there are traces of a trench around 10 meters wide beneath the pyramid and this trench is in perfect alignment with the axis of the ramp of the port.

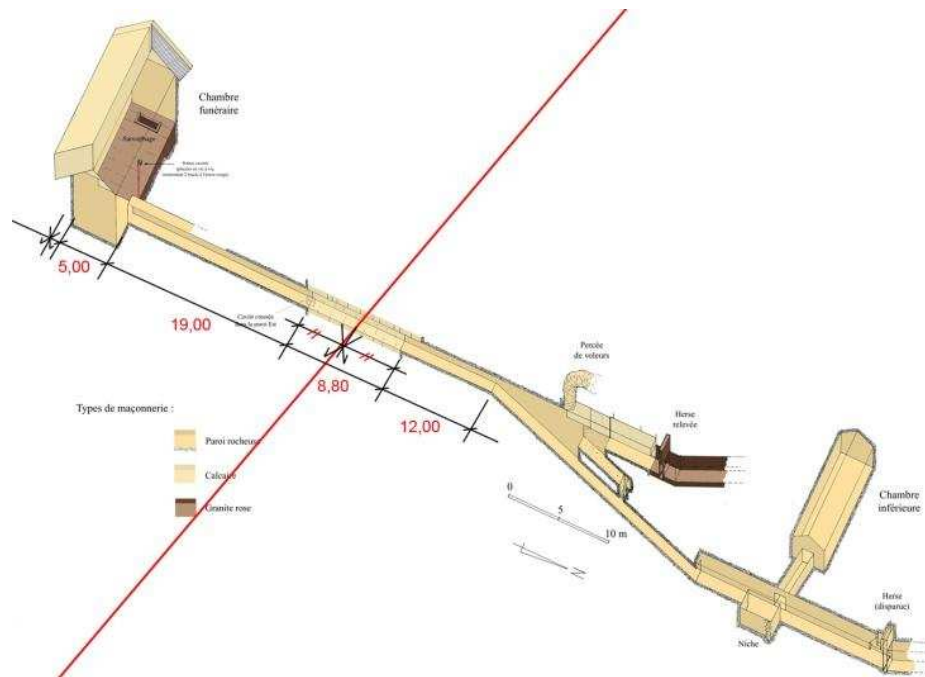

The red axis of the ramp from the port crosses the corridor leading to the King's Chamber in Khafre's pyramid. The designers had to "build" this part of the corridor with masonry while the rest of the corridor was simply dug through the bedrock. In other words, as the corridor was being dug through the bedrock, when the builders came to the point where the corridor intersected the counterweight trench they had to patch the intersection with masonry. This patched section does exist in the corridor, exactly where the counterweight trench would be.

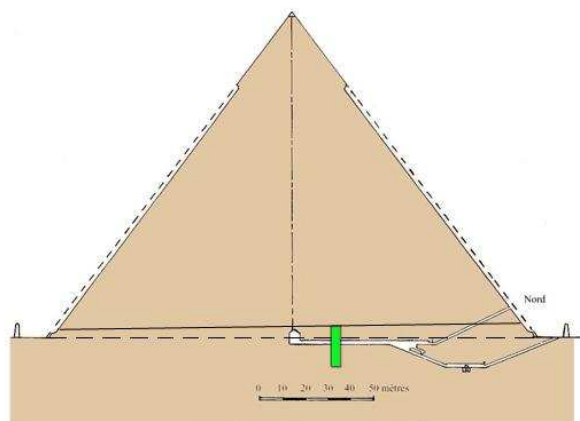

The trench (in green) has nothing to do with Khafre's pyramid.

**The blocks of the base of the exterior ramp of Khufu's pyramid**

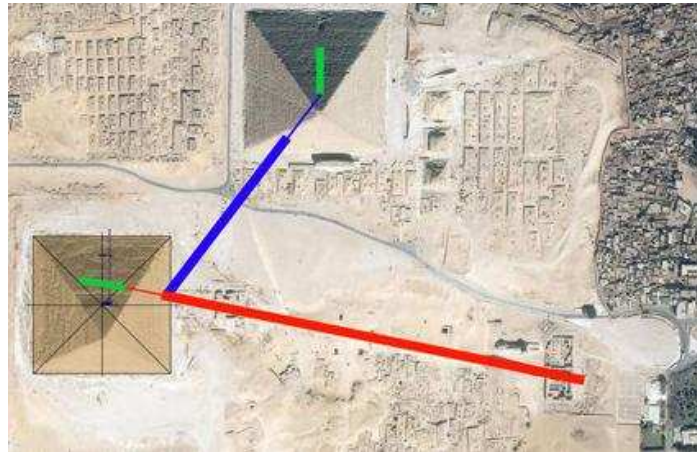

The ramp from the port (in red) meets up with the exterior ramp of Khufu's pyramid (in blue). The counterweights were in continuation of the ramps (in green)



On this photo, one can see an outgrowth towards the pyramid of Khufu



Some slabs turn towards the South/West corner of Khufu's pyramid



The pavement ends suddenly as if this area was cut neat



The present platform is made of 2 to 3 layers of huge blocks



On the right, a large block has even been laid with its strata vertical, showing a temporary usefulness. Once again, people show the scale of the blocks.



South-Eastern area: the paving sets out at a gentle slope towards the South



It does the same towards the East

### **The quarries on the construction site of Khufu's pyramid**

The German Egyptologist Pr Dr Rainer Stadelmann did a remarkable study of the history, topography and morphology of the Great Sphinx. This study was published for a communication at the "Académie des Arts et Belles Lettres" in 1999:

[http://www.persee.fr/web/revues/home/prescript/article/crai\\_0065-0536\\_1999\\_num\\_143\\_3\\_16044](http://www.persee.fr/web/revues/home/prescript/article/crai_0065-0536_1999_num_143_3_16044)

Extracts of Pr Dr Rainer Stadelmann's communication

*« La limite méridionale de ces carrières est clairement définie par l'escarpement rocheux sur lequel plus tard Chéphren a placé la chaussée menant à sa propre pyramide. C'est justement à cause de ces carrières de Chéops que la chaussée de Chéphren ne dessine pas un trajet E-O vers son temple de la vallée, mais dévie visiblement vers le sud. Cela signifie que pour tracer le trajet de sa chaussée, Chéphren devait tenir compte d'une disposition déjà existante, d'une structure importante plus ancienne qu'il fallait contourner, ce qui exigeait un changement du cours normal de la chaussée et non l'inverse, comme on le prétend toujours. Or cet objet ne peut avoir été que le Grand Sphinx. Ainsi, la cavité rectangulaire au centre duquel le sphinx a été taillé à même le roc participe sûrement des carrières de Chéops. Ceci peut être appuyé par la comparaison de la pierre des différentes assises de la Grande Pyramide avec les diverses couches de formation observées sur le rocher qui forme le corps du Sphinx et les parois de cavité. La séquence des blocs provenant des couches diverses est clairement identifiée par le type d'érosion. A l'origine, la surface de la roche dans laquelle on a taillé le Grand Sphinx devait être considérablement plus élevée que la plaine rocheuse qui s'étend vers le sud. Il est probable qu'elle était aussi haute que l'avancée nord sur laquelle on a construit les tombes des fils royaux ou au moins de hauteur égale à celle de la butte à l'extrême sud qui recèle les vestiges des carrières de Chéphren et Mykérinos.*

*Toute la masse du promontoire original entre le niveau actuel du sol de la dépression du Sphinx et le niveau supérieur du plateau de la Grande Pyramide, quelque 20 m de hauteur, a été extraite pour fournir les blocs du corps de la maçonnerie de la Grande Pyramide.*

*On se demande alors pourquoi Chéops aurait fortuitement laissé à la limite sud de ses carrières une butte où plus tard Chéphren et ses artistes auraient improvisé l'idée d'y sculpter un Sphinx, comme on le suppose généralement. Selon moi cette idée n'est pas convaincante.*

*Naturellement, le seul fait que le Grand Sphinx occupe la limite méridionale des carrières de Chéops ne prouve pas encore que c'est indubitablement Chéops qui a eu l'idée de le faire sculpter. Pourtant, il est impensable que sous un règne aussi prodigieux et dans un complexe funéraire d'une conception si rigoureuse et grande, dont la perfection rarement égalée lui vaut encore aujourd'hui d'être considéré comme une des merveilles, on ait par hasard laissé un roc aux abords méridionaux du chantier le plus extraordinaire. Qui plus est, le roc est situé tout près de la vallée et donc visible aux habitants de la résidence tout proche. »*

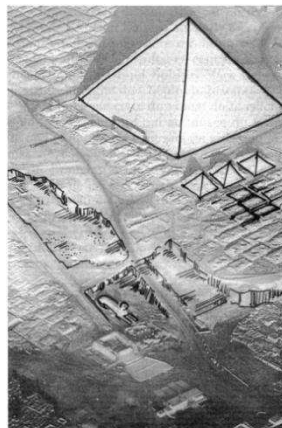

## The Sphinx

Its head was not cut out of a mound but in a very limited rocky outcrop resulting from reduced erosion of a stratum of much harder limestone.



Left, view of the Sphinx from the road leading to the South face of the pyramid of Khufu; in the background we can see the "Hill of Crows" (Heit el-Gurob) that overlooks the wadi. Zooming in on this hill, several outcrops come out of it, one of which is particularly interesting.



The photograph on the left has been inverted to put it in the same direction as the Sphinx; we can see some similarities: front feet, head, body and rear thigh. The right-hand photograph shows the original position. We can easily understand that it is more tempting and easier to sculpt a head in an outcrop of this type rather than attack an entire mound. Furthermore, the reduced size of the Sphinx's head in relation to its body certainly depends on the size of the original outcrop. If the sculptors had used a whole mound, surely they would have carved the head in proportion to the body.



A Sphinx's head could very well have been sculpted in the outcrop in the left-hand photo.

One also can observe that the bedrock surrounding the outcrop is uniformly eroded; one can therefore assume that the topography around the head of the future Sphinx was identical. So the Royal Causeway of Khafre could very well have passed to the right of this outcrop without great difficulty.



The Lower Temple of Khafre would have been constructed along the axis of this causeway, as for Menkaure. The sphinx would have been sculpted and excavated and its Temple would have been in the same place, but to the left of the Lower Temple of Khafre.



In reality, the topographers did not have this option because they did not draw the Royal Causeway on undisturbed ground, but had to take account of the existing layout on the plateau.

In fact, they advised the architects and surveyors to make use of an old abandoned construction ramp to site the Royal Causeway of Khafre, with all that that implied for the plans for the High and Low Temples: the offsetting of the entrances from the processional corridor into these Temples. These disadvantages were minimal compared with the enormous gain from re-using an existing ramp as the foundation for the Royal Causeway.



## Clues unrevealed

In case where the 34 clues above would not be seen as sufficient to support the credibility of the theory, several other clues are kept in reserve.



Credits for photos, 3D graphics and drawings

Jean-Pierre Houdin, Dassault Systèmes, Bulleplexiglass, Farid Atiya, Ludwig Borchardt, Gilles Dormion, Franck Monnier, Rudolph Gantenbrink, Jon Bodsworth, Keith Payne, Craig B. Smith, Dieter Arnold, Rainer Stadelmann, Piazzzi Smyth, Edgar Brothers, EDF Foundation, Gedeon Programmes, Lehnert and Landrock, Waseda University