



HAL
open science

Comparisons of Different Propulsion Topologies of Service Ships for Islands

Feriel Abderrahmane, Fabian Amoros, Wael Sammari, Ignacio Hernando-Gil, Ionel Vechiu, Walter Lhomme, Jean-Frédéric Charpentier

► **To cite this version:**

Feriel Abderrahmane, Fabian Amoros, Wael Sammari, Ignacio Hernando-Gil, Ionel Vechiu, et al.. Comparisons of Different Propulsion Topologies of Service Ships for Islands. The 6th International Conference on Renewable Energy and Environment Engineering (REEE 2023), Aug 2023, Brest, France. pp.02006, 10.1051/e3sconf/202343302006 . hal-04318327

HAL Id: hal-04318327

<https://hal.science/hal-04318327>

Submitted on 1 Dec 2023

HAL is a multi-disciplinary open access archive for the deposit and dissemination of scientific research documents, whether they are published or not. The documents may come from teaching and research institutions in France or abroad, or from public or private research centers.

L'archive ouverte pluridisciplinaire **HAL**, est destinée au dépôt et à la diffusion de documents scientifiques de niveau recherche, publiés ou non, émanant des établissements d'enseignement et de recherche français ou étrangers, des laboratoires publics ou privés.

Comparisons of Different Propulsion Topologies of Service Ships for Islands

Feriel Abderrahmane^{1,2*}, Fabian Amoros^{1,3,4}, Wael Sammari^{1,5}, Ignacio Hernando-Gil², Ionel Vechiu², Walter Lhomme³, and Jean-Frédéric Charpentier¹

¹French Naval Academy Research Institute, Brest, France

²Univ. Bordeaux, ESTIA-Institute of Technology, EstiaR, F-64210 Bidart, France

³Univ. Lille, Arts et Metiers Institute of Technology, Centrale Lille, Junia, ULR 2697 – L2EP, F-59000 Lille, France

⁴SEGULA Technologies, Le Havre, France

⁵Menzel Bourguiba Naval Academy, Tunisie

Abstract. Maritime transport is one of the main drivers of a country's economic growth. Up to 90% of world trade is carried out by sea. However, the high consumption of fossil fuels leads to significant greenhouse gas emissions and other pollutants emissions, such as the nitrogen dioxide (NO_x) and the sulfur oxides (SO_x). Decarbonizing maritime transport, through the transition to electrified propulsion, is a major challenge for researchers and engineers in the naval construction sector. This paper studies electric, thermal and hybrid energy/propulsion solutions for ships serving the island of Ouessant, located near Brittany's coast in France. Using a simplified methodology based on power flows between the various components (batteries, generators, fuel cells), the most suitable type of energy is investigated according to the case study, for efficient and effective vessel use. The simulations show that the energy consumption of the fully electric solution is the best with 5.78 MWh consumed against, for example, 13.89 MWh equivalent of fuel for the classic diesel topology.

1 Introduction

The maritime sector plays a significant role in the global greenhouse gas and pollutant emissions, with 2.2% CO₂ emissions and 15% of NO_x emissions. These emissions are set to increase significantly and this trend highlights the need for a transition to sustainable energy sources on board [1].

To accelerate maritime transportation transition, strict regulations have been introduced by the International Maritime Organization (IMO) to reduce the total volume of ship annual greenhouse gas emissions by 50% in 2050 compared to 2008 [2]. This regulatory context offers a framework for developing and adopting of cleaner propulsion technologies for ships.

Island regions are vulnerable to the energy crisis and represent an opportunity to experiment reduced scale solution. By adopting sustainable energy solutions for energy and transportation, they can reduce their pollutant emissions and contribute to global efforts.

Electrification and hybridization of transportation solutions are seen as promising solutions to contribute to preserve the ecosystems of islands and improve the quality of life of the inhabitants. The objective of this paper is to compare different propulsion topologies (electric, hybrid and thermal) to define the best configuration that will reduce polluting emissions while ensuring the reliability and safety of maritime transport services for islands. The presented study focuses on a

typical case based on one of vessel serving the island of Ouessant: the Fromveur II (shown on Figure 1).

In section 2, the case study is presented, then, the models used for simulations are described using Energetic Macroscopic Representation (EMR) [3] in section 3. Finally, the simulation results for the different propulsion topologies are presented and discussed.

2 Case Study

2.1. Ouessant Island Maritime Services: General Specifications

Ouessant is part of the Molène Archipelago which is located near the Brittany Coast in France. Ouessant is the



Figure 1 : The Fromveur II, a ship serving island

* Corresponding author: feriel.abderrahmane@ecole-navale.fr

largest island in the Iroise Sea, with a surface area of 15.59 km². Each week, more than 100 islanders as well as tourists use the ship connecting Ouessant to the mainland [4]. Two ships are used for this purpose.

The case study is based on the specifications of one of the two ships serving island, the Fromveur II (Figure 1) whose characteristics are presented in Table 1.

Table 1: Characteristic of the Fromveur II [5]

Characteristics	Fromveur II
Dimensions	45,00 x 9,90 x 6,76 m
Draught	2.6 m
Capacity	365 passengers
Total power	3 300 kW
Motorization	2 A.B.C. diesel engine, model 8DZC
Propulsion	2 propellers
Speed	15 knots
Construction	2011 by Piriou Concarneau

2.2 Brest-Ouessant Travel: Existing Ship Mission Profile Analysis

The Fromveur II has a propulsion system consisting of two diesel engines, two propulsion shafts, two gearboxes and two propellers. A typical mission profile is determined to investigate the energy needed by the system. Speed data is retrieved using AIS (Automatic Identification System) data sent by the vessel each few seconds during the ship mission. The speed profile of the typical mission is given in Figure 2. From the hull of the boat, the advance resistance and a first approximation of power required to propel the ship is calculated using Calcoque Software [5]. The cruising speed of Fromveur II is around 15 knots (28 km/h) (shown on Figure 2), and the average shaft power needed is around 1.5 MW [6].

A round trip from Brest to Ouessant Island takes about 4 hours, consuming around 4MWh of energy.

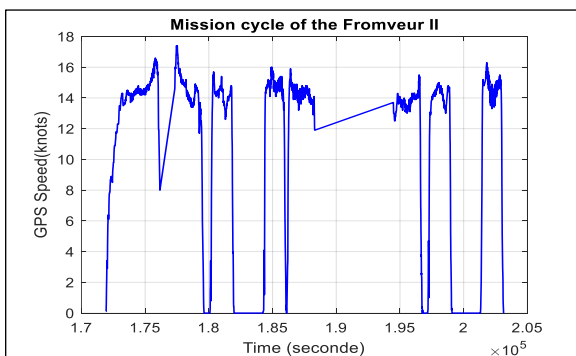

Figure 2 : Speed profile for a typical mission of the studied ship

The aim of the presented work is to simulate the behavior of the energy/propulsion system of the ship in this working cycle with a simple but accurate model, taking into account the various electrical, mechanical and hydrodynamic phenomena associated with the components of several possible naval propulsion chain (thermal, hybrid or fully electric).

3 Modeling of the Propulsion System

Four configurations of the energy propulsion chain are studied. The first is the existing thermal configuration based on mechanical diesel propulsion (which is used as a reference). The second is an all-electric solution where the vessel is powered by batteries and an electric motor. The third is a series hybrid topology using an ICE (Internal Combustion Engine) and a battery. The fourth one is a series hybrid topology using a hydrogen fuel cell and a battery.

Each element of the four propulsion systems (thermal, electric, thermal-hybrid and hydrogen-hybrid) is modelled, from the energy sources to the ship's environment, and represented using the Macroscopic Energy Representation (EMR). In order to simplify the EMR of the four systems, the two propulsion shaft lines are assumed to be identical and to operate symmetrically. Power adaptation blocks are used to adapt the thrust and power demand of the energy sources.

EMR is a graphical formalism suited for the synthetic representation of multidisciplinary energy systems, based on interconnected sub-systems according to integral causality and action-reaction principle [3].

A global model of each propulsion chain has been implemented in Matlab Simulink environment to evaluate the various possible configurations, as well as various control strategies, in order to improve the performance of the propulsion system and compare the solution performances.

3.1 Diesel Propulsion

The conventional diesel propulsion EMR is represented in Figure 3.

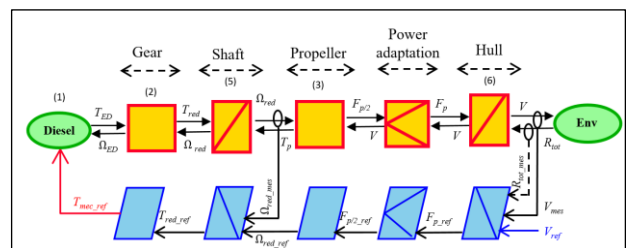

Figure 3 : EMR of the classic thermal architecture

3.1.1 Diesel Engine Model

The diesel engine is a controlled mechanical torque source. A static model, which provides the torque T_{mec} , as a function of a reference torque, $T_{mec-ref}$, is used [7].

$$T_{mec} = T_{mec-ref} \quad (1)$$

The consumption is estimated with a generic specific consumption curve corresponding to a marine diesel [8].

3.1.2 Gear

A gear is used to adapt the torque and speed between the motor and the propeller shaft with a conversion factor K_{red} . Ω_{red} and Ω_{mec} are respectively the gear and diesel engine rotation speeds and T_{red} is the gear torque.

$$\begin{cases} T_{red} = K_{red} \cdot T_{mec} \\ \Omega_{red} = \frac{\Omega_{mec}}{K_{red}} \end{cases} \quad (2)$$

3.1.3 Propeller Model

A mono-quadrant propeller model is used to calculate the thrust F_p and the hydrodynamic torque T_p needed for the propeller as a function of a given operating point J characterized by the vessel's speed of advance and the propeller's speed rotation [9].

$$\begin{cases} F_p = \rho \cdot n^2 \cdot D^4 \cdot K_t(J) \\ T_p = \rho \cdot n^2 \cdot D^5 \cdot K_q(J) \end{cases} \quad (3)$$

Where D is the diameter of the propeller, ρ is the density of the water and K_t , K_q (Figure 4) are empirical coefficients given as a function of J , the advance parameter for a given propeller

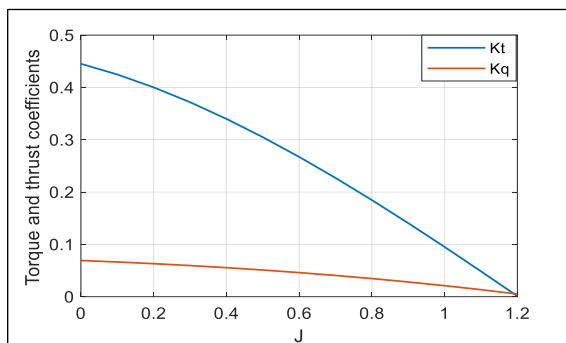

Figure 4: K_t and K_q curves of the considered propeller

$$J = \frac{V}{n \cdot D} \quad (4)$$

V is the advance speed and n the propeller rotational speed in rotations per second (rps). These no dimensional numbers (K_t and K_q) are determined by testing reduced scale propeller model in test basin [9].

3.1.4 Resistance to Advance

The force required to move the vessel forward at a given speed depends on the characteristics of the boat's hull and environmental conditions such as currents, waves, wind, etc. The resultant of these resistive forces is the resistance to advance R_{tot} . Figure 6 shows R_{tot} as a function of the ship speed given by the naval architecture software Calcoque [5].

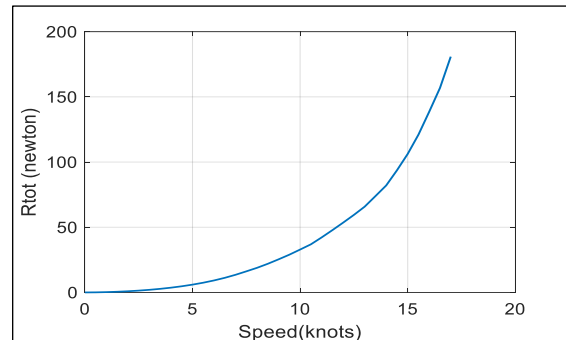

Figure 6: Resistance to advance curve of the considered ship hull

3.1.5 Dynamic Mechanical Modeling of Shaft and Hull

The— fundamental principle of dynamics is applied to the shaft and the hull, the two main mechanical dynamic to consider (as given in the equation 5 and 6).

$$\Omega_{red} = \frac{1}{I} \cdot \int (T_{red} - T_p) \cdot dt \quad (5)$$

$$V = \frac{1}{M} \cdot \int (F_p - R_{tot}) \cdot dt \quad (6)$$

with M the total mass of the vessel and I the inertia of all the rotating part leaded by the propeller shaft (considered on the propeller side of the gear box)

3.2 Hybrid Propulsion

In this configuration, a hybrid series propulsion with a diesel engine and a battery pack is considered.

The subsystems modelled in the first part (conventional propulsion components) will be reused. The EMR of this topology is illustrated in Figure 5. A common DC bus links the diesel generator set with the battery and its converter. The considered solution is a not plug-in hybrid solution.

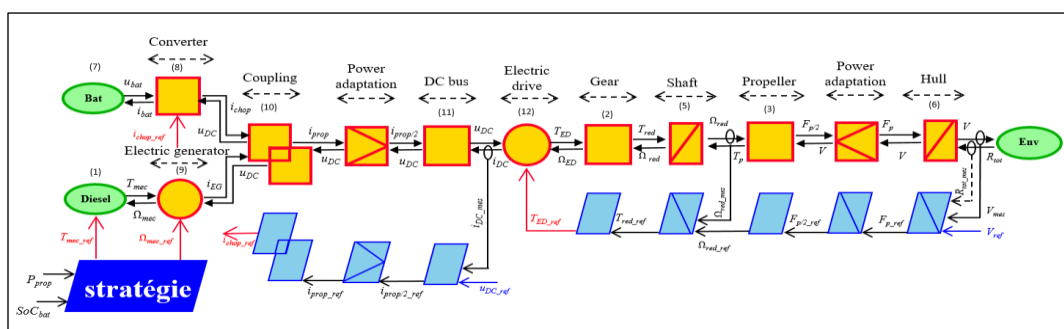

Figure 5: EMR of Hybrid Diesel - Battery Propulsion System

3.2.1 Battery

The battery is considered as a voltage source U_{bat} composed of an open circuit voltage (U_{ocv}) as a function of the battery state of charge (SoC), in series with an internal resistance (R_{int}), i_{bat} is the current of the battery and C_{bat} is its capacity in A.h [7].

$$\begin{cases} U_{bat} = U_{ocv}(SoC) - R_{int} \cdot i_{bat} \\ SoC(t) = SoC_0 - \frac{C_{bat}}{3600} \cdot \int i_{bat} \cdot dt \end{cases} \quad (7)$$

3.2.2 Battery to Bus Converter

A DC/DC converter is used to connect the battery and the DC bus. It is modelled by a constant efficiency $\eta_{chop}=0.95$. U_{DC} is the DC bus voltage controlled to be constant and equal to 1200 V and i_{chop} the current exchanged between the converter and the bus.

$$\begin{cases} i_{chop} = i_{chop-ref} \\ i_{bat} = \eta_{chop} \cdot i_{chop-ref} \cdot \frac{U_{DC}}{U_{bat}} \end{cases} \quad (8)$$

3.2.3 Electric Generator

An AC electric generator and rectifier are connected to the diesel engine. The mechanical power ($P_{eng} = T_{mec} \cdot \Omega_{mec}$) delivered is converted into electrical power ($P_{EG} = U_{DC} \cdot i_{EG}$) and then transferred to the propulsion chain.

$$\begin{cases} \Omega_{mec} = \Omega_{mec-ref} \\ i_{EG} = \frac{T_{mec} \cdot \Omega_{mec}}{U_{DC} \cdot \eta_{EG}} \end{cases} \quad (9)$$

Where i_{EG} is the current provided by the electric generator and rectifier to the DC bus and η_{EG} is the efficiency of this system. The electrical generator is controlled to constant speed and the delivered electrical power is controlled by excitation winding current.

3.2.4 Power Balancing

The system is assumed to be controlled to maintain the DC bus value at a constant rated value. Consequently, the current which supply the propulsion motor and drive i_{prop} , is the sum of the currents provided to the DC bus by the electric generator i_{EG} , and the battery via the chopper i_{chop} (equation 10).

$$i_{prop} = i_{chop} + i_{EG} \quad (10)$$

3.2.5 DC Bus

The power transfer from the sources to the propulsion system on the DC bus is modelled considering the losses

on the resistance of the DC bus r_{dc} (only power losses are considered in steady state)

$$U_{dc} = r_{dc} \cdot (i_{prop/2} - i_{DC}) \quad (11)$$

3.2.6 Electric Propulsion Model

The propulsion electric motor and drive torque are considered to be perfectly controlled (using a speed control loop to follow the speed reference related to the mission profile). Thus, a very simple model is considered for the propulsion motor and drive. This model is shown in equation (12) and allows evaluating the current consumed by the drive in the DC bus. T_{ED} is the machine torque, Ω_{ED} is machine rotation speed and η_{ED} is the efficiency of the motor and drive which is assumed to be constant equal to 0.95.

$$\begin{cases} T_{ED} = T_{ED-ref} \\ i_{DC} = \frac{T_{ED} \cdot \Omega_{ED}}{U_{DC} \cdot \eta_{ED}} \end{cases} \quad (12)$$

3.3 Electric Propulsion

This section focuses on a fully electric propulsion solution represented by the EMR in Figure 7. The subsystems modelled in the hybrid model (section 3.2) are re-used but the only power sources are batteries, which are charged during ship stops.

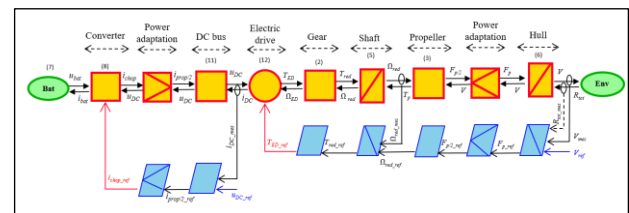

Figure 7 : EMR of the Full Battery Electric Propulsion Configuration.

3.4 Hydrogen Hybrid Propulsion

This section focuses on the hybrid hydrogen modelization. The EMR of this topology is the same as the hybrid diesel – battery (section 3.2) with the diesel generator being replaced by a fuel cell system. The fuel cell system EMR is represented in Figure 8. The considered solution is not plug-in hydrogen hybrid solution.

3.4.1 Fuel Cell Mathematical Model

The PEMFC fuel cell is an assembly of several cells where, the fuel cell voltage v_{fc} is the sum of the potential of each elementary cell v_{cell} .

$$v_{fc} = N_{cell} \cdot v_{cell} \quad (13)$$

Where N_{cell} is the number of cells.

The voltage v_{fc} generated by the fuel cell depends on the electrolysis chemical reaction occurring in each cell [10]. These chemical reactions are empirically modelled using

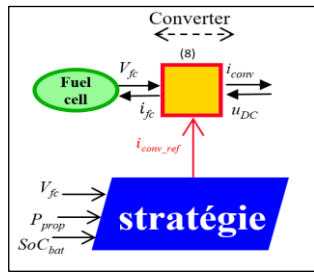

Figure 8 : EMR of the Fuel Cell System

a polarization curve represented in the Figure 9. The shape of this curve depends on the specific characteristics of the fuel cell, such as thickness, pore size and humidification

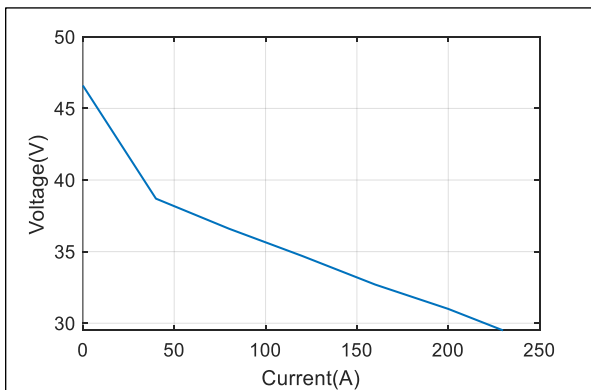

Figure 9: Polarization curve of the used Fuel Cell

4 Results and Comparative Analysis

Simulation results and considered system configuration and sizing are presented in Figure 10 and Table 2. Figure 10 shows the primary power consumption on board. This is the power related to fuel consumption (fuel mass flow rate multiplied by fuel lower heating value (LVH)) for configurations 1,2 and 4 or electric power provided by the battery pack for configuration 3.

Table 2 highlight primary energy consumption and global efficiency of the electrical chain. The calculation of the efficiency is made as follows:

$$\eta_{system} = \frac{\int F_p \cdot V \cdot dt}{\sum Consumed Energy} \quad (14)$$

Table 2 : Comparative analysis of the different topologies studied

Topologies	Power plan	Installed power	Primary Energy consumption	Energy Efficiency
Diesel	Diesel generators	Diesel generators 2×1.65 MW	13.89MWh	0.27
Hybrid diesel	Diesel generator and battery	Diesel gen=2MW Battery= 4.32MW	14.57MWh	0.26
Electric	Battery	Battery=7.9.MW	5.785MWh	0.65
Hydrogen hybrid	Fuel cell and battery	Fuel cell=3MW Battery=4.32MW	10.128MWh	0.37

For example, hybrid hydrogen efficiency is the ratio between the total kinetic energy consumed by the ship during the mission and the potential amount of the energy corresponding to the consumed H2 (H2 mass multiplied by H2 LHV). For Hybrid configuration a equivalent consumption is added to bring the final state of charge of the battery pack to the initial state of charge $SoC_0 = SoC_{end\ of\ mission}$.

As propellers and gear are supposed to remain the same between the four different topologies simulated, only the electrical propulsion machine and the energy sources efficiencies explain the variation observed.

It is important to note that design does not have a significant impact on the results. Considering the hypotheses made, efficiency of each component are not dependent on their design.

In terms of energy and efficiency, the fully battery-electric solution is the best one with 5.785 MWh of primary energy consumption. High efficiencies of both the sources and the electric drive explain that the global efficiency of the full electric system is close to the efficiency of the propeller (around 0.7). However, installing 6 MWh of Li-ion batteries also means adding around 60t to the original 100t weight of the ship (Typical Marine LFP battery – 100Wh/kg) and leads to high capital expenditure. The ageing of the battery during the lifetime of the ship has also to be considered.

Investment costs and recharge infrastructure need further studies and logistic improvement.

Hybrid diesel topology is the worst ones for energy savings but are still, nowadays, the most mature alternative to the current diesel architecture. The multiplicity of the components can explain the poor energy efficiency compared to the classical diesel topology (generator, converters, motors, etc.) and that the ship operates mostly near its rated operating point (speed around 15 knots). Thus, the variation of propulsion power during the mission profile is not so important. This is why the conventional propulsion system is globally a little more efficient than the diesel hybrid system because in conventional cases the diesel engines are mainly used in their efficient operating area (engine load higher than 50%).

However, hybrid diesel system allows zero-emission mode for dynamic phases of the cycle or in harbour/sensitive, areas, cost, and weight of the batteries can be limited with an optimized design and sizing.

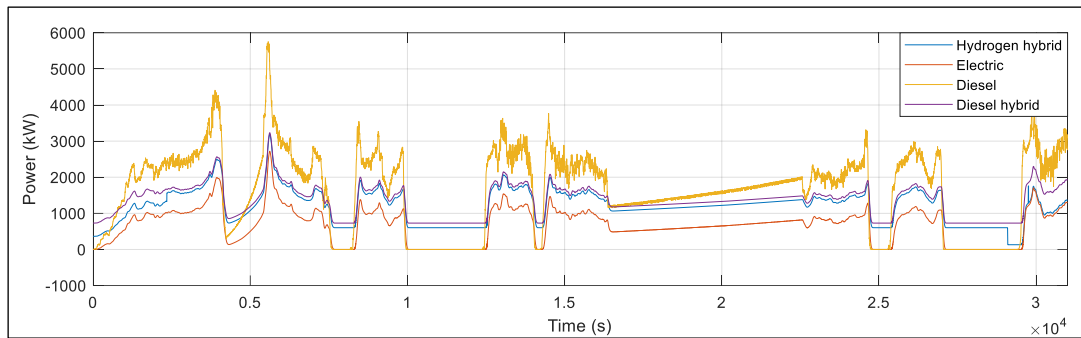

Figure 10 : Primary Energy Consumption (Primary Power)

The hydrogen solution is a promising one. The efficiency is better than with a diesel thanks to the fuel cell efficiency, which is almost twice better than the Internal Combustion Engine (~ 0.6 for a fuel cell against ~ 0.36 for a diesel engine). However, the maturity of the solutions has to be proven. Particularly safety and green H₂ supply and local production have to be studied. The cost of the fuel cell system is also very restraining.

5 Conclusion

In this paper, naval propulsion simulator has been implemented and is used to study different propulsive architecture for ships connecting Ouessant to the mainland. Primary energy and global system efficiencies for 4 configurations (full electric, conventional diesel, hybrid battery-diesel and the hybrid hydrogen-battery configurations) has been estimate and compared leading to the conclusion: the electric propulsion has a better efficiency while hybrid hydrogen is a very promising solution and hybrid diesel battery is an already mature solution.

Plug-in hybrid solution has not been studied despise being a key solution to reduce the emission and the operating costs of hybrid architectures. Another interesting track is to consider, for hybrid systems, a combination of several kinds of energy storage systems to improve system dynamic behavior and reliability (as for example the association of batteries and super capacitors).

In the next steps of the work presented in this paper, the energetic analysis will be improved adopting more advanced power management strategies.

References

1. N. Bennabi, J. F. Charpentier, H. Menana, J. Y. Billard, et P. Genet, « Hybrid propulsion systems for small ships: Context and challenges », in *2016 XXII International Conference on Electrical Machines (ICEM)*, Lausanne, Switzerland: IEEE, sept. 2016, p. 2948-2954. doi: 10.1109/ICELMACH.2016.7732943.
2. 250_IMO_submission_Talanoa_Dialogue_April_2018.pdf. Consulté le: 18 juillet 2023. [En ligne]. Disponible sur: https://unfccc.int/sites/default/files/resource/250_IMO%20submission_Talanoa%20Dialogue_April%202018.pdf
3. A. Bouscayrol, J.-P. Hautier, et B. Lemaire-Semail, « Graphic Formalisms for the Control of Multi-Physical Energetic Systems: COG and EMR », in *Systemic Design Methodologies for Electrical Energy Systems*, John Wiley & Sons, Ltd, 2012, p. 89-124. doi: 10.1002/9781118569863.ch3.
4. Population OUESSANT: statistics of Ouessant 29242. <https://www.map-france.com/Ouessant-29242/population-Ouessant.html> (consulted on 18 July 2023).
5. F. Grinnaert, J.-Y. Billard, et J.-M. Laurens, « Calcoque: a fully 3D ship hydrostatic solver », *STAB2015*, p. 203, 2015.
6. Marine marchande, Fromveur II global description, <https://www.marine-marchande.net/Reportages/Fromveur/0-Fromveur.htm> (consulted on 18 July 2023).
7. A. Pam, A. Bouscayrol, P. Fiani, et F. Faval, « Comparison of different models for energy management strategy design of a parallel hybrid electric vehicle: Impact of the rotating masses », *IET Electrical Syst in Trans*, vol. 11, n° 1, p. 36-46, mars 2021, doi: 10.1049/els2.12003.
8. L. C. W. Yuan, T. Tjahjowidodo, G. S. G. Lee, R. Chan, et A. K. Adnanes, « Equivalent consumption minimization strategy for hybrid all-electric tugboats to optimize fuel savings », in *2016 American control conference (ACC)*, IEEE, 2016, p. 6803-6808.
9. J. S. Carlton, *Marine propellers and propulsion*, 2nd ed. Amsterdam: Butterworth-Heinemann, 2007.
10. C. Spiegel, *PEM fuel cell modeling and simulation using MATLAB*. Elsevier, 2011.