



HAL
open science

PV Hosting Capacity in LV Networks by Combining Customer Voltage Sensitivity and Reliability Analysis

Mikka Kisuule, Mike Brian Ndawula, Chenghong Gu, Ignacio Hernando-Gil

► **To cite this version:**

Mikka Kisuule, Mike Brian Ndawula, Chenghong Gu, Ignacio Hernando-Gil. PV Hosting Capacity in LV Networks by Combining Customer Voltage Sensitivity and Reliability Analysis. *Energies*, 2023, 16 (16), pp.5893. 10.3390/en16165893 . hal-04318167

HAL Id: hal-04318167

<https://hal.science/hal-04318167>

Submitted on 1 Dec 2023

HAL is a multi-disciplinary open access archive for the deposit and dissemination of scientific research documents, whether they are published or not. The documents may come from teaching and research institutions in France or abroad, or from public or private research centers.

L'archive ouverte pluridisciplinaire **HAL**, est destinée au dépôt et à la diffusion de documents scientifiques de niveau recherche, publiés ou non, émanant des établissements d'enseignement et de recherche français ou étrangers, des laboratoires publics ou privés.

Article

PV Hosting Capacity in LV Networks by Combining Customer Voltage Sensitivity and Reliability Analysis

Mikka Kisuule ^{1,*}, Mike Brian Ndawula ², Chenghong Gu ³ and Ignacio Hernando-Gil ^{4,*}

¹ Department of Electrical and Computer Engineering, College of Engineering Design Art and Technology, Makerere University, Kampala P.O. Box 7062, Uganda

² Research and Development, Energy Division, Orijtech Inc., Palo Alto, CA 94301, USA

³ Centre for Sustainable Power Distribution, Department of Electronic and Electrical Engineering, University of Bath, Bath BA2 7AY, UK

⁴ ESTIA Institute of Technology, University of Bordeaux, 64210 Bidart, France

* Correspondence: kisuule01@gmail.com (M.K.); i.hernandogil@estia.fr (I.H.-G.)

Abstract: This paper investigates voltage regulation in low voltage (LV) networks under different loading conditions of a supply network, with increased levels of distributed generation, and in particular with a diverse range of locational solar photovoltaic (PV) penetration. This topic has been researched extensively, with beneficial impacts expected up to a certain point when reverse power flows begin to negatively impact customers connected to the distribution system. In this paper, a voltage-based approach that utilizes novel voltage-based reliability indices is proposed to analyse the risk and reliability of the LV supply feeder, as well as its PV hosting capacity. The proposed indices are directly comparable to results from a probabilistic reliability assessment. The operation of the network is simulated for different PV scenarios to investigate the impacts of increased PV penetration, the location of PV on the feeder, and loading conditions of the MV supply network on the reliability results. It can be seen that all reliability indices improve with increased PV penetration levels when the supply network is heavily loaded and conversely deteriorate when the supply network is lightly loaded. Moreover, bus voltages improve when an on-load tap changer is fitted at the secondary transformer which leads to better reliability performance as the occurrence and duration of low voltage violations are reduced in all PV scenarios. The approach in this paper is opposed to the conventional reliability assessment, which considers sustained interruptions to customers caused by failure of network components, and thus contributes to a comprehensive analysis of quality of service by considering transient events (i.e., voltage related) in the LV distribution network.

Keywords: low voltage supply; on-load tap changer; PV hosting capacity; risk and reliability assessment; voltage sensitivity analysis



Citation: Kisuule, M.; Ndawula, M.B.; Gu, C.; Hernando-Gil, I. PV Hosting Capacity in LV Networks by Combining Customer Voltage Sensitivity and Reliability Analysis. *Energies* **2023**, *16*, 5893. <https://doi.org/10.3390/en16165893>

Academic Editor: Alon Kuperman

Received: 4 July 2023

Revised: 1 August 2023

Accepted: 7 August 2023

Published: 9 August 2023



Copyright: © 2023 by the authors. Licensee MDPI, Basel, Switzerland. This article is an open access article distributed under the terms and conditions of the Creative Commons Attribution (CC BY) license (<https://creativecommons.org/licenses/by/4.0/>).

1. Introduction

To cope with the upcoming low-carbon electricity systems, it is imperative to increase the portfolio of flexibility sources cost-effectively and sustainably [1–4]. The increased penetration of residential distributed energy resources (DER) within the last mile of the power supply network, such as rooftop photovoltaic (PV) systems and batteries [5], is posing many challenges and opportunities to distribution companies and third-party aggregators [6]. Ancillary services and wholesale energy prospects can be offered by this type of technologies. However, if their aggregated response is not effectively managed, both active power imports and exports might result in voltages and currents well beyond the limits of their networks. In particular, considering exports from solar PV microgeneration, the solution commonly adopted is a region-wide, fixed export limit at the customer's power delivery point (i.e., a smart meter) [7].

Moreover, low voltage (LV) microgrids are increasingly becoming more relevant to the reliability of power distribution systems [8–10]. This makes the computation of the system's

reliability evaluation quite complex, especially for long-term system planning. Therefore, there is a need to assess the reliability of LV networks amidst the increasing penetration of distributed generation [11]. This paper considers the influence of PV microgeneration technologies on the overall network performance and quality of supply of LV residential customers, which further contributes to the network models and demand-response scenarios developed by the authors in [12,13], assessing the changes in active/reactive power flows, system losses, voltage profiles, and harmonic emissions due to the combined effects of implementing microgeneration, energy storage, and demand-response. Given that the voltage along LV feeders is more correlated to active power than reactive power, higher levels of PV penetration can lead to a voltage rise along the feeder with customers at the end of long feeders who are traditionally exposed to low-voltage problems more likely to experience higher voltages at high PV penetration levels [14]. Additionally, the location (node and phase) and capacity of the PV—termed collectively as ‘allocation’ are fundamental to the network characterisation to accurately reflect the network’s performance in the presence of PV. It is also critical to consider that the load demand and PV generation outputs are stochastic and influenced by external factors and uncertainties [15].

However, reliability and power quality studies are usually performed independently, resulting in two different sets of data and indices, although they often describe phenomena or events with the same origin and impact on the analysed power supply system [16]. These include any problem manifested in voltage, current, or frequency deviations that result in a failure or malfunction of the customer’s equipment [17]. Research in [18] details the adverse effects of the high level of PV penetration in LV networks, such as voltage sags/swells, phase unbalance, distortion in the coordination and operation of protection equipment, harmonics, etc. Voltage regulation is a key issue faced by many utilities in LV feeders [19] with a voltage rise occurring during the peak generation hours, with little or no load due to the power flow reversal and reactive power disturbance in the circuit. Accordingly, one of the objectives of this paper is to combine the impact of the frequency and duration of momentary and sustained interruptions, such as the methodology proposed in [20] where a single reliability metric gathers different classes of outages, at the same time, their frequency and duration, and thus the effective time of each interruption experienced by a customer can be established. These reliability results can be compared to a probabilistic methodology based on a Monte-Carlo Simulation of component failure rates and repair times as done in [21,22].

Accordingly, sensitivity analyses on the voltage variations on LV feeders have been extensively researched. For example, research in [23,24] provides an overview of the various voltage analyses of distribution systems with distributed generation and compares different research on the voltage variations concerning solar PV penetration. The LV network, normally consisting of an individual secondary transformer, presents different limits depending on multiple factors, considering that voltage violations in the LV network can be avoided even at high penetration levels (around 90% of feeder maximum load [25]) in certain conditions. The voltage rise is highly sensitive to the position and concentration of PVs along the feeder [26]. However, it is possible to manage a large penetration of PVs without major changes in the LV network parameters by accurately estimating the size, location, and concentration of PVs along the feeder length [27,28]. One of the prime obstacles in absorbing/hosting large amounts of PV safely is the voltage control at the medium voltage (MV) level, which is normally more sensitive than at the LV network level [29,30].

Utilities are challenged with operating the network reliably without violations [31] while connecting as much PV and ensuring compliance with grid standards and regulations [18]. The modelling of the actual load to actual PV profiles provides a more comprehensive approach. While high PV penetration limits (up to 90% in [12]) can be tolerated in LV networks without voltage violations, the voltage rise depends on the location and size of the PV systems along the feeder. For example, the formation of LV microgrids in general, with PV technologies in particular, may have a substantial impact

on the reliability of the distribution system, however, they might create a great complexity in the computation for the system's reliability evaluation [22]. In this regard, one of the PV contributions might be to provide alternative supply and hence improve the reliability of customer loads during some of the network interruptions.

However, the PV output power may stochastically change due to environmental conditions. The PV penetration level in a distribution system depends upon multiple factors, such as load type and profile, solar irradiance level and cloud conditions, PV concentration along the feeders, network topology and PV generator connection types (single phase or three-phase). Research in [32] conducted modelling and analysis of various scenarios of PV penetration levels considering clouding and seasons based on data from the UK and Europe. It must be anticipated that the load profile of the network strongly affects the impacts of PV penetration levels. If high demand hours coincide with peak PV generation, at, for example, noon, network distribution losses are hence reduced and the need for peak shaving is overcome. However, if the network supplies a considerably low demand, the feeders might experience a voltage rise and reverse power flow [23].

Building on the work conducted in [1], this paper offers a new risk and reliability perspective to the conventional voltage analyses (i.e., in [16,33]) performed on distribution LV feeders, presenting the following main contributions and innovations:

- (a) Assessment of the reliability of an LV power distribution network for different PV penetration levels and locations along an LV feeder.
- (b) Assessment of the frequency of occurrences and duration times when the beneficial impacts from the PV hosting capacity in the distribution network start to diminish.
- (c) A critical review of the existing reliability and power quality indices and using them as a basis for the creation and definition of novel system performance indicators.
- (d) Development of novel reliability indices to quantify the changes in network reliability based on the voltage-based reliability assessment methodology in [33] that and compare the results to a probabilistic reliability assessment that uses the time-sequential Monte-Carlo Simulation (MCS) as in [21].

2. Methodology

The proposed methodology involves the assessment of the reliability of the power distribution system considering different PV penetration levels and locations along an LV feeder. The reliability assessment is based on the extent to which voltages at all buses remain within the regulator-set voltage limits (typically +10%/−6% in UK and Europe) as in [1]. Firstly, an MCS is carried out to establish the well-known reliability indicators of the System Average Interruption Frequency Index (SAIFI), System Average Interruption Duration Index (SAIDI), and Energy Not Supplied (ENS). The main inputs to the MCS are the component failure rates and repair times which are converted to system states using the inverse transform method. As an enhancement to the conventional MCS method, this research models component failure rates as time-varying based on a 'bathtub' distribution curve. This accurately captures the higher likelihood of component failure right after installation and towards the end of its service. More details on the enhanced MCS used in this research are provided in [21,22]. Then, different network scenarios are used to check how voltages at different network buses are affected by both the level of PV penetration and the location of PV generation along the feeder. This is quantified using novel voltage-based indicators that quantify the impact of PV penetration from the reliability perspective. The subsections detail the steps followed.

2.1. Modelling of the LV Feeder

A typical LV feeder in the urban load sub-sector (i.e., metropolitan) of the distribution network models, as developed in [32], is adopted for this analysis with a total demand of 156 customers supplied by 7 load points (LPs) and a maximum load of 354 kW. The feeder is supplied by a 0.5 MVA 11/0.415 kV secondary substation transformer and consists of underground cables (UC) as shown in Figure 1. This paper uses a time-varying residential

demand profile that is derived from the after-diversity maximum demand (ADMD) for each load point in the network, as in [21]. Each customer is modelled to have an ADMD of 2.27 kW [34].

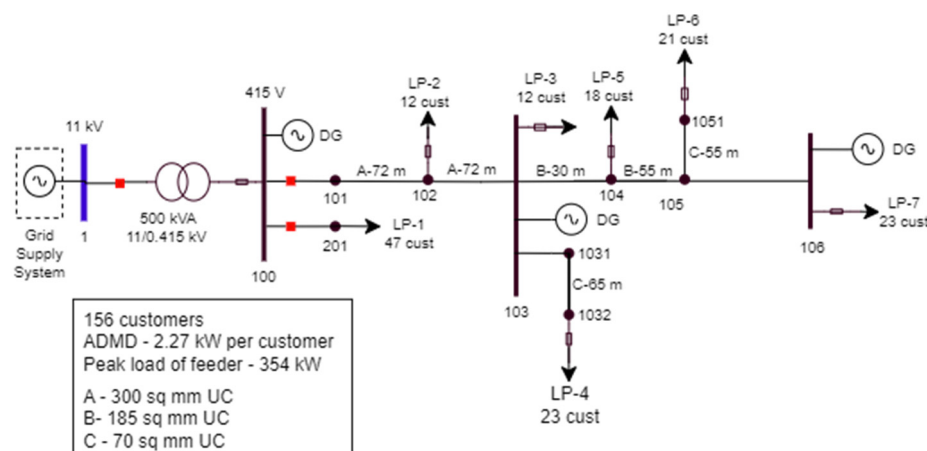

Figure 1. Modified highly urban LV network model.

2.2. Modelling of PV Penetration Levels

The PV is modelled as a generator with a set-point output that varies sequentially in 30-min time steps following the typical PV generation profiles developed in [32]. The impact of the PV on the reliability and hosting capacity of the feeder depends on its size and location in the distribution circuit. The analysis considers the realistic PV profiles described in [22] which more accurately model the intermittence and temporal variation of PV. Therefore, the PV is connected at the end of the feeder during different loading conditions of the MV supply network, to quantify how the reliability from a voltage perspective is affected. The PV scenarios are detailed in Table 1. For each PV scenario, different penetration levels (0, 50% and 100%) were considered in the analysis with PV connected to the terminal bus. Further, the paper investigates the variation in the voltage violations experienced by customers connected to each of the buses for each of the PV scenarios.

Table 1. PV Scenarios.

ID	PV Penetration	MV Supply Network
S-1(a)	Base case; no PV connected	Normal loading
S-1(b)	50% PV penetration	
S-1(c)	100% PV penetration	
S-2(a)	Base case; no PV connected	Heavy loading
S-2(b)	50% PV penetration	
S-2(c)	100% PV penetration	
S-3(a)	Base case; no PV connected	Light loading
S-3(b)	50% PV penetration	
S-3(c)	100% PV penetration	

2.3. Voltage Analysis

The voltage analysis was conducted with the reference voltage set to model:

- I. A heavily loaded MV supply network;
- II. A normally loaded MV supply network;
- III. A lightly loaded MV supply network.

The voltage thresholds used to define the loading of the supply network are 0.94 pu and 1.1 pu corresponding to the acceptable voltage limits (i.e., +10%/−6%) according to British Standard on Voltage Characteristics of electricity supplied by distribution network operators (DNOs) BS EN 50160 [35]. Any sustained violation of these limits can

lead to adverse effects on customers' equipment and the accelerated ageing of network components [23]. Bus voltages in the analysis are denominated in per unit (pu).

This paper focuses on the entire spectrum of network loadings because typically overloaded LV networks suffer from low voltages whereby the beneficial impact of PV can be better evaluated for those low voltages. Conversely, the negative impacts of PV such as overvoltage are accentuated in lightly loaded networks. A load flow algorithm as in [1] is used to ascertain the voltages at each of the buses along the main feeder when different PV capacities are placed at the beginning, middle, and end of the feeder. The voltages are then evaluated to determine the reliability impact on the network as an entire system and at each bus as well as the hosting capacity of the feeder, from a voltage perspective. The algorithm uses time-varying PV generation in 30-min timesteps according to irradiance data from [32] and runs a load flow analysis to derive the steady-state voltages at each bus throughout the day. In this paper, the voltage profiles at the terminal bus of the feeder were of keen interest as customers connected to this bus often experience the lowest voltages and worst quality of service (QoS). These are the worst-served customers, and it is expected that PV connected to this bus will significantly improve the QoS.

2.4. Voltage-Based Reliability Assessment

To analyse the reliability and transient risks of the LV feeder from a voltage perspective, voltage-based reliability indices are proposed. The voltage variation indices used were selected for their scalability so that they can be applicable in more complex analyses for larger networks and the resulting system-like averages that can be compared to conventional indices like SAIFI and SAIDI, which measure the frequency and duration of system outages respectively. The MV supply system is interrupted whenever any network bus voltage goes below or above the set threshold, accounting for the voltage violation, as a result of the action of the transitory protection settings. Therefore, the proposed indices quantify the frequency and duration of these interruptions to derive the customer-wise risk of supply disconnection and the overall system-wide reliability. This approach differs from the conventional reliability assessment, which looks at sustained interruptions to customers caused by failure of network components, and thus lacks a more detailed analysis of power quality by looking at (voltage-related) transient events [1].

Accordingly, the System Average RMS (Voltage) Frequency Index (SARFI_x) and System Average RMS (Voltage) Duration Index (SARDI_x) are calculated by counting the number and duration of interruptions respectively at all load points and dividing by the total number of customers in the network as in (1) and (2). The system-wide indices, SARFI_x and SARDI_x are derived from [21] and calculate the average number and duration of interruptions per customer served on the entire feeder. An interruption is defined as a timestep when the bus voltage to which a customer is connected falls below the set voltage threshold x . These system-wide indices are comparable to SAIFI and SAIDI respectively and can be used by utilities to plan for network operations and improve reliability, from a voltage perspective. Energy not Supplied (ENS) per customer calculates the unserved energy to customers during interruptions as in (3). Customer Average RMS (Voltage) Frequency Index (CARFI_x) and Customer Average RMS (Voltage) Duration Index (CARDI_x) are proposed for the reliability and hosting capacity assessment of the test distribution network. These indices are calculated by dividing the total number of interruptions and interruption duration by only the affected customers as in (4) and (5) [1].

$$SARFI_x = \frac{\sum N_i}{N_T} \quad (1)$$

$$SARDI_x = \frac{\sum D_i}{N_T} \quad (2)$$

$$ENS_x = \frac{\sum D_i \times L_i}{N_T} \quad (3)$$

$$CARFI_x = \frac{\sum N_i}{N_C} \quad (4)$$

$$CARDI_x = \frac{\sum D_i}{N_C} \quad (5)$$

where x is the RMS voltage threshold; N_i is the number of voltage deviations experienced by customers, with magnitudes below (or above) the set voltage threshold, x ; D_i is the duration of voltage deviations experienced by customers, with magnitudes below (or above) set voltage threshold, x ; L_i is the load interrupted to customers during voltage deviations with magnitudes below (or above) set voltage threshold, x ; N_T is the number of the total number of customers served on the feeder. N_C is the total number of customers affected by a given interruption. The customer-based indices are calculated based on only the customers affected by the interruptions and provide a customer perspective on the reliability assessment as they better depict and quantify how customers are affected.

In the analysis, the threshold voltage, x was set to 0.94 pu and 1.1 pu to correspond to the acceptable lowest voltage limit and highest voltage limit, respectively, at LV. To the best knowledge of the authors, while SARFI $_x$ and SARDI $_x$ are introduced in [21], all the other indicators described above have been proposed in this paper drawing from the need to obtain a more comprehensive reliability assessment from the DNO and customer perspective using standardised indices. The results of the reliability assessment for the different distributed generation (PV) scenarios (i.e., PV in this study can inform utilities about how voltage profiles will vary given the different locations and penetrations of PV and how this may affect network reliability, the need and frequency of application of network interventions, and network protection). Ultimately, this analysis can improve the quantification of reliability and risks of voltage deviations in LV networks with increased levels of PV penetration [1].

2.5. Impact of On-Load Tap Changers

Research in e.g., [36] details the potential benefits of adopting distribution transformers fitted with an on-load tap changer (OLTC) in LV networks regarding voltage regulation with high penetration of PV. Various OLTC-based control strategies have been presented to DNOs such as capacitor banks that provide additional voltage support. In this paper, the benefits of adopting the OLTC-fitted transformer, set to control the bus in the middle of the feeder (bus 103), are quantified from a reliability perspective. Whenever the bus voltage being monitored goes below the low voltage threshold, the voltage at the secondary of the transformer is boosted to 1 pu by increasing the transformer tap position accordingly. It is expected that the voltage profile along the feeder will be greatly impacted by the OLTC as the voltage at the monitored bus will be kept above the low voltage threshold at all times of the day. The impact of the OLTC on the reliability of the feeder from a voltage perspective is investigated for the scenario when the supply network is heavily loaded as the voltages along the feeder are expected to be low from the onset.

3. Results

3.1. Conventional Reliability Assessment

As a base reference to the proposed study, the conventional reliability of the modified highly-urban network in Figure 1 is established by conducting an MCS of the network behaviour based on the power component failure rates and repair times adopted from [12]. The methodology to perform the MCS is detailed in [21] and the results are presented in Table 2 which include SAIFI, SAIDI, ENS and customer average interruption duration index (CAIDI).

Table 2. Conventional Reliability Assessment Results.

Reliability Index	Unit	Result
SAIFI	Interruptions/customer/year	0.60
SAIDI	Hours/customer/year	18.10
CAIDI	Hours/interrupted customer/year	20.99
ENS	kWh/customer/year	386.64

3.2. Voltage-Based Reliability Assessment

Based on the obtained results, the aforementioned reliability indices are computed for the different scenarios and are presented in Table 3. A comparison is made between different PV penetration levels (i.e., 50% and 100% Realistic PV profiles to validate the incremental impacts of increasing the PV penetration levels for different loading conditions of the supply network). From the results, it can be seen that the system-wide reliability indices (i.e., ENS, SARFI, and SARDI improve with increased PV penetration levels when the MV supply network is heavily and normally loaded, while they regress when the MV supply network is lightly loaded).

Table 3. Reliability indices from the different PV scenarios.

	Normally Loaded Network S-1		Heavily Loaded Network S-2		Lightly Loaded Network S-3
		% change from base case		% change from the base case	
SARFI (interruptions/customer/year)					
Base case (No PV)	86.57		622.37		0
50% PV	46.79	−45.95%	587.27	−5.64%	14.03
100% PV	35.09	−59.46%	498.36	−19.92%	49.13
SARDI (hours/customer/year)					
Base case (No PV)	43.29		311.18		0
50% PV	23.39	−45.95%	293.63	−5.64%	7.02
100% PV	17.54	−59.46%	249.18	−19.92%	24.56
CARFI (interruptions/affected customer/year)					
Base case (No PV)	217.82		890.73		0
50% PV	165.90	−23.83%	840.50	−5.64%	104.28
100% PV	124.43	−42.87%	713.25	−19.92%	174.20
CARDI (hours/interrupted customer/year)					
Base case (No PV)	108.91		445.36		0
50% PV	82.95	−23.83%	420.25	−5.64%	52.14
100% PV	62.21	−42.87%	356.62	−19.92%	87.10
ENS (kWh/customer/year)					
Base case	788		5232		0
50% PV	436.00	−44.67%	5008.00	−4.28%	126.00
100% PV	327.00	−58.50%	4205.00	−19.63%	452.00

In S-1, 50% Realistic PV penetration levels lead to an improvement of 45.95% in SARFI and SARDI, 23.83% improvement in CARDI and CARFI, and 44.67% in ENS. These reliability improvements are higher with 100% Realistic PV penetration where SARFI and SARDI reduce by 59.46%, CARDI and CARFI reduce by 42.87%, and ENS by 58.50%. For a normally

loaded MV supply network, increased PV penetration levels lead to significant reliability improvement for customers connected to the feeder. In each case, the improvement in ENS and SARDI is larger than in SARFI due to the trend seen in Figure 2 where increased PV penetration levels reduce the duration of interruptions at affected buses by pushing the start time of violations in the day. Accordingly, when PV is introduced in the network, customers faced with low voltage violations experience significantly shorter interruptions compared to a reduction in the number of interruptions.

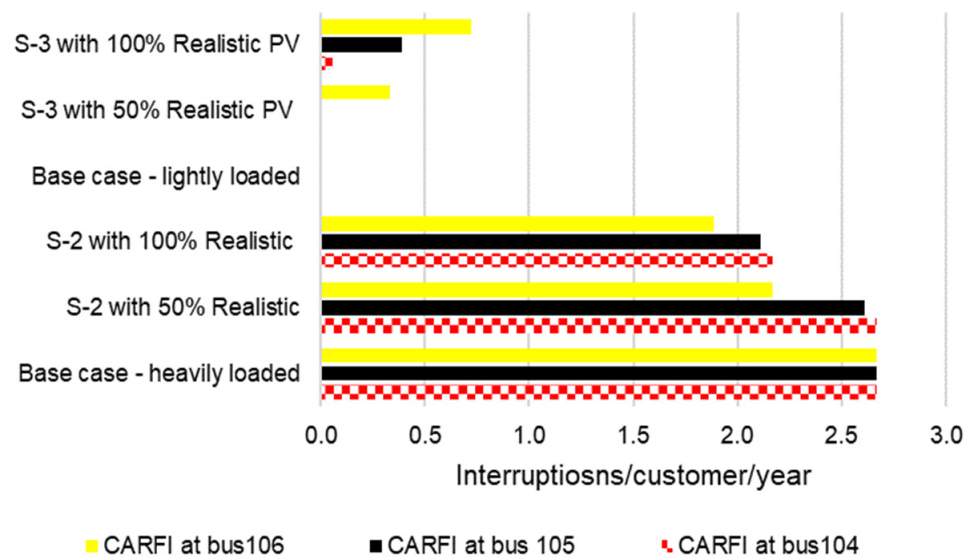

Figure 2. CARFI at bus 106, 105, and 104 for the different PV scenarios.

In S-2, while PV leads to an improvement in all reliability indices, it is clear that 50% penetration levels have a much lower impact than the 100% penetration levels due to the low voltages at all buses in the base case with all below the low voltage threshold throughout the day and going as low as 0.86 pu. While 50% penetration levels lead to a 5.64% reduction in SAIFI/SAIDI/CARDI/CARFI and a 4.28% reduction in ENS, 100% penetration levels lead to a 19.92% reduction in SAIFI/SAIDI/CARDI/CARFI and 19.63% reduction in ENS. This is seen in Figure 3B where the bus voltages are all boosted in comparison to Figure 3A but all remain at the 0.94 pu threshold. Customers, therefore, don't experience a significant improvement in reliability with low PV penetration levels compared with bigger reliability benefits realised at high PV penetration levels. Additionally, all the customers are affected in all PV scenarios as all buses violate the low voltage threshold at some point during the day leading to the same values for the system-wide indices (SAIFI and SAIDI) and the customer-based ones (CARDI and CARFI).

In S-3, the base case doesn't result in overvoltage violations at any of the buses and arising violations with the introduction of PV seen in Figure 3 lead to a deterioration in the reliability as seen by an increase in all reliability indices. It is noted that only bus 106 violates at 50% PV penetration level with bus 105 also violating at 100% penetration level. This implies that only the customers at the end of the feeder will be affected from a reliability perspective.

A further step is taken to analyse the reliability performance of customers connected at each of the last 3 buses (bus 104, 105, and 106) on the feeder by computing their location CARFI and CARDI as shown in the results in Figures 2 and 4, respectively.

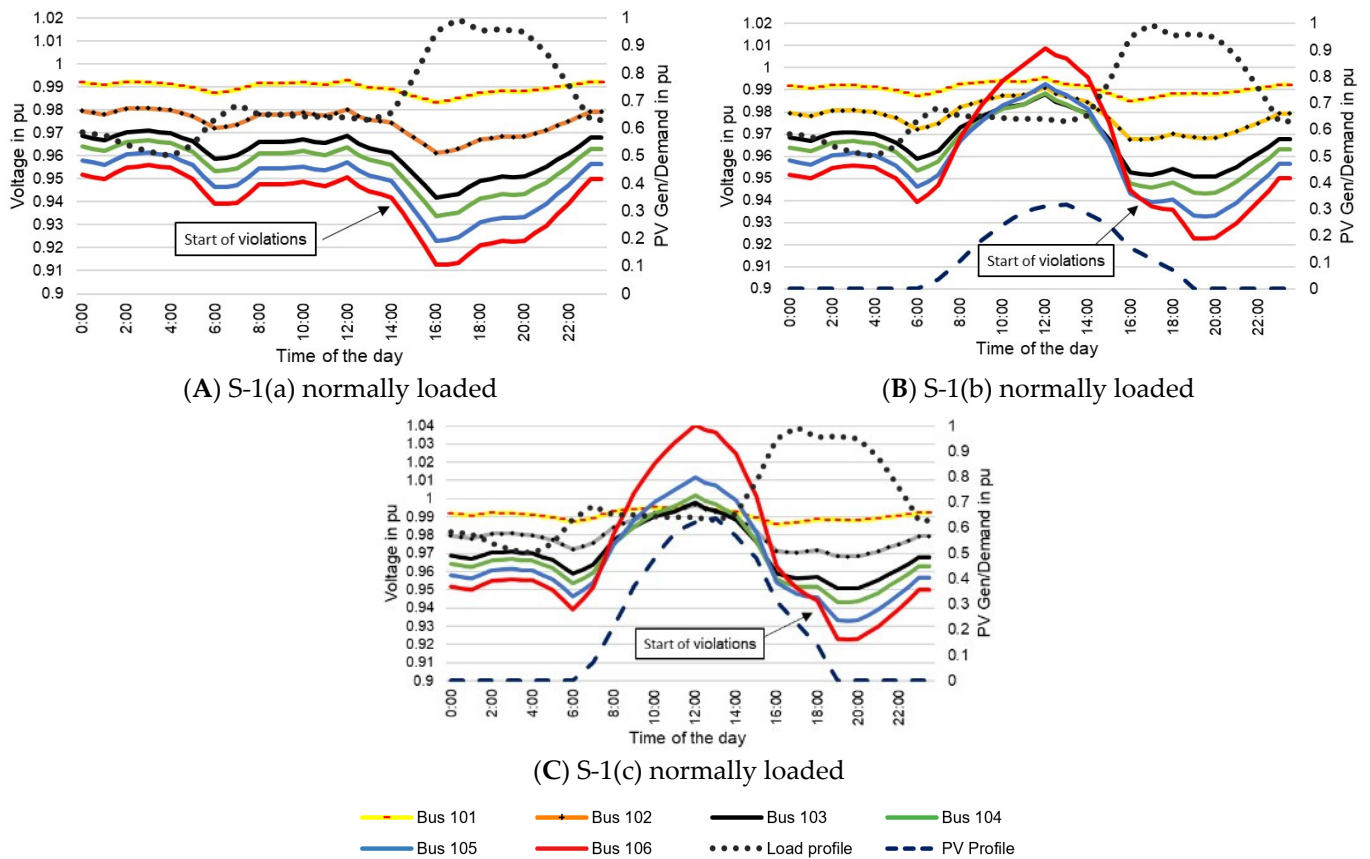

Figure 3. Bus voltages along the feeder connected to a normally loaded network with; (A) No PV, (B) 50% Realistic PV, and (C) 100% Realistic PV.

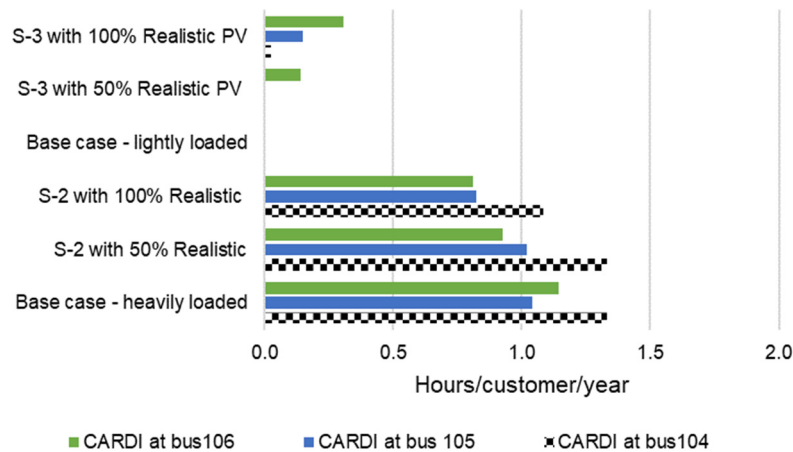

Figure 4. CARDI at bus 106, 105, and 104 for the different PV scenarios.

When the MV supply network is heavily loaded (S-2), CARDI at the three terminal buses reduces at higher PV penetration levels. At 50% PV, only customers at bus 104 experience fewer average number of interruptions in a year (from 2.7 to 2.2 interruptions per customer per year). At 100% PV, CARDI at bus 104 further reduces to 1.9 interruptions per customer per year. Customers at buses 105 and 106 also realise a reduction in CARDI from 2.7 to 2.2 interruptions per customer per year. Under light loading conditions of the MV supply network (S-3), customers at the three buses do not experience any interruptions with 50% PV leading to an increase in CARDI at bus 106 to 0.35 interruptions per customer per year further worsening to 0.7 interruptions per customer per year at 100% PV where

CARFI at bus 105 also reduces to 0.4 interruptions per customer per year. The loading conditions of the MV supply network determine the reliability improvement/deterioration experienced by customers in terms of the frequency of interruptions.

When the MV supply network is heavily loaded, CARDI at the three terminal buses on the feeder reduces at higher levels of PV penetration. It can also be seen that for all the PV scenarios, each customer at bus 104 experiences the longest interruptions in the year. This is because bus 104 has the least number of connected customers so they are worst impacted by the voltage violations, from a customer perspective. When 50% PV is connected, there is no change in CARDI at bus 104 and 105 with only bus 106 registering an improvement from 1.15 to 0.9 h per customer per year. When 100% PV is connected, all 3 buses register a decrease in CARDI to 0.8 h per customer per year for buses 105 and 106 with bus 104 registering 1.1 h per customer per year. This implies that while customers at the end of the feeder benefit from PV when the MV supply network is overloaded, these improvements are more significant when customers are connected to the same bus as buses 105 and 106. DNOs can therefore improve the reliability of customers by adding PV at the end of LV feeders, more so when many are connected to the same bus.

3.3. Voltage Variations at Different PV Locations and Penetration Levels

This analysis accurately models PV solar irradiance using ‘realistic’ PV profiles as opposed to the use of ‘idealistic’ PV profiles that do not account for the temporal variation of PV throughout a diurnal cycle [22]. PV is connected to the end of the feeder supplied by a normally loaded MV supply network and modelled with 50% and 100% penetration in scenarios S-1(b) and S-1(c), respectively. The resulting bus voltages are shown in Figure 3A–C.

It is clear that in scenario S-1(a) (i.e., the base case), low voltage violations occur only on buses 105 and 106, which are both located at the end of the feeder (Figure 1). The voltage violations occur during peak demand times i.e., from 2 p.m.–10.30 p.m. and last a total of 8.5 h. Voltage violations are also experienced at bus 104 between 4 p.m. and 6 p.m. Through the addition of PV, the start time of these violations is delayed, thereby reducing their duration. For example, in S-1(b), 50% PV penetration at the end of the feeder results in violations only on buses 105 and 106 starting at 4 p.m. which is 2 h later than the start time in the base case; in S-1(c), 100% PV penetration results in violations at the same buses starting at 6 p.m. (4 h later than the base case).

It can be seen that while all the bus voltages are boosted during the hours of PV generation, improvements in the reliability from the voltage perspective can be seen from the delayed start of low voltage violations at the 3 buses at the end of the feeder that occurs during the peak demand hours when there is no PV connected. The violations at bus 104 are eliminated even at 50% penetration levels with customers at bus 105 and 106 experiencing violations that are shorter by 23.5% at 50% penetration level and 47% at 100% PV penetration level. These reliability improvements underscore the benefit of adding PV at the end of the feeder even when the MV supply network is normally loaded albeit being less significant than when the supply network is heavily loaded where all the buses tend to violate when no PV is connected as explained below.

Figure 5 shows the bus voltages along the feeder when the MV supply network is heavily loaded as modelled in S-2.

In S-2(a), all the bus voltages along the feeder violate the low voltage threshold (indicated by the double red) for most of the day. This presents an opportunity for significant reliability improvements by reducing the duration and occurrence of the violations, mostly during the hours of the day with high PV generation. S-2(b) and S-2(c) depict how much the bus voltages are boosted during the PV hours at 50% and 100% penetration levels respectively. At 50% penetration level, only bus 106 stops violating between 9 a.m. and 3 p.m. extending to between 8 a.m. and 4 p.m. at 100% penetration level along with violations at bus 105 were eliminated from 9 a.m. to 3 p.m. and those at bus 104 and 103 eliminated between 10 a.m. and 2 p.m. This significant reduction in the duration (6 h less at 50%

penetration and 22 h less at 100% penetration level) and frequency of the violations leads to an improvement in the quality of supply of connected customers.

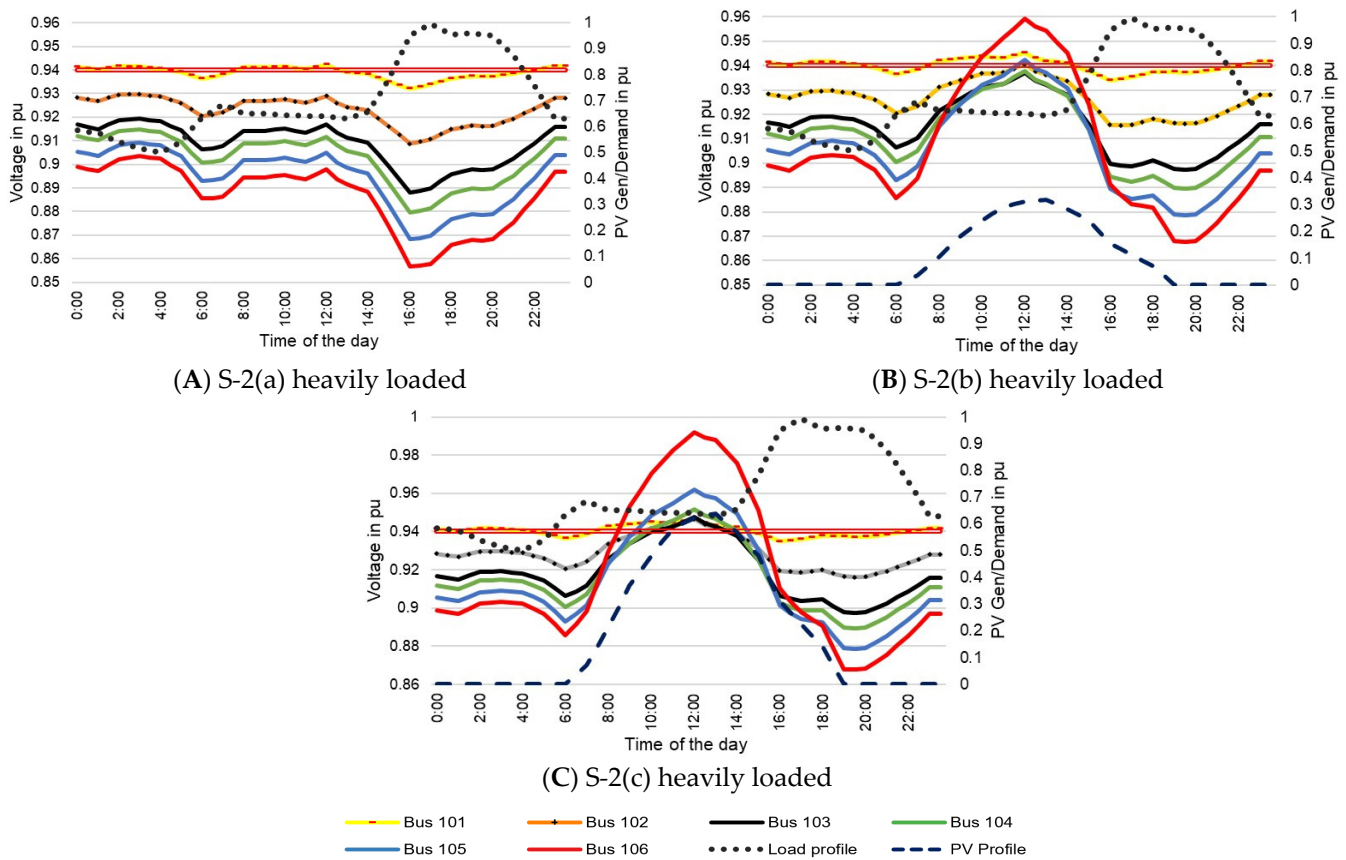

Figure 5. Bus voltages along the feeder connected to a heavily loaded network with; (A) No PV, (B) 50% Realistic PV, and (C) 100% Realistic PV.

Converse to the S-1 scenario when the network is normally loaded, it is evident from the above that introduction of PV at the end of the feeder when the MV supply network is heavily loaded progressively leads to a reliability improvement by reducing the occurrence of violations during the hours of PV generation given that all the buses violate when no PV is connected. Bigger reliability improvements are realised at the buses towards the end of the feeder with higher PV penetration levels. It is worth noting that when the network is heavily loaded, it is expected that the DNO will typically boost voltages on the MV network by integrating on-load tap changers on the distribution transformers and capacitor banks at the feeder substation. The scenario in the former is investigated in Section 3.3.

The impact of PV connected in a lightly loaded MV supply network is modelled using scenario S-3 and the resulting feeder bus voltages are shown in Figure 6 with a focus on violation of the upper voltage threshold (indicated by a double red line).

With no PV connected as in S-3(a), none of the buses experience voltage violations however with the introduction of PV, buses at the end of the feeder start to experience over voltages above the threshold. At 50% PV penetration in S-3(b), the feeder terminal bus (106) exceeds the set voltage threshold from 10.30 a.m. to 2 p.m. (3.5 h) while this voltage violation lasts 6 h i.e., from 9 a.m. and 3 p.m. when there is 100% PV penetration in S-3(c). Bus 105 also experiences voltage violations from 10 a.m. to 2 p.m. (4 h) with 100% PV penetration in S-3(c). These overvoltage violations underpin the detrimental effect of downstream PV when the supply network is lightly loaded.

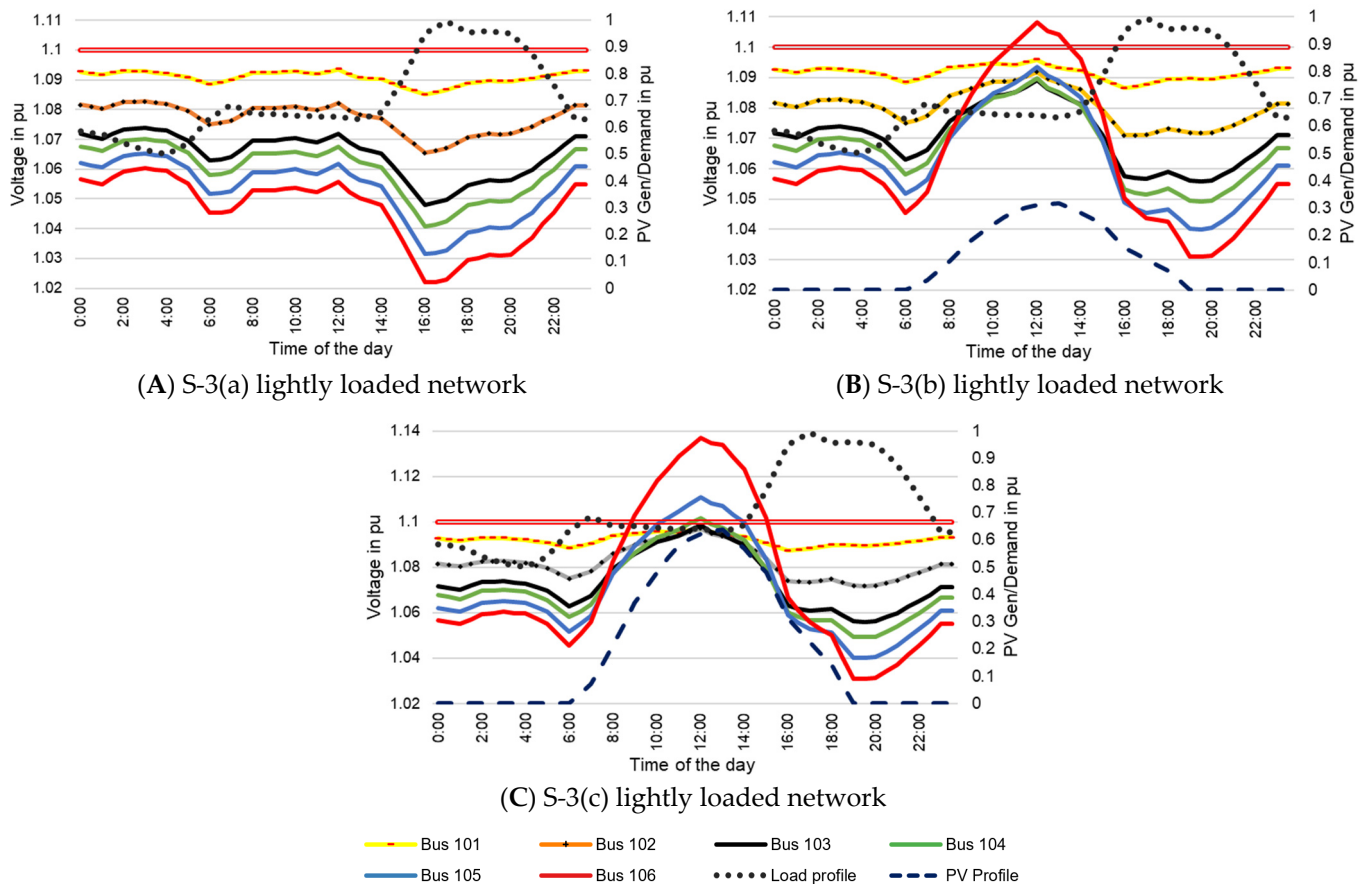

Figure 6. Bus voltages along the feeder connected to a lightly loaded network with; (A) No PV, (B) 50% Realistic PV, and (C) 100% Realistic PV.

In summary, the results show that the impact of PV on the bus voltages is greatly affected by the loading conditions of the supply network and the level of PV penetration. For heavily loaded supply MV networks, PV significantly reduces the frequency and duration of undervoltage violations while for normally loaded networks, PV reduces instances of undervoltage violations while also delaying their time of occurrence which reduces the risk of loss of supply during certain periods of the day. Conversely, the PV has negative effects when the network is lightly loaded as some bus voltages start to violate the upper voltage threshold.

3.4. Impact on the Voltages at the Feeder Terminal Bus

Finally, considering the different loading conditions of the MV supply network, the impact of the different PV penetration levels on the voltage levels of the terminal bus (106) is analysed in Figure 7a,b.

Figure 7a shows the beneficial impact of PV in heavily loaded networks, by reducing the undervoltage violations for the connected customers. Conversely, Figure 7b shows the detrimental effect of PV increasing overvoltage violations in lightly loaded networks. The double red line indicates the relevant voltage threshold.

When the MV supply network is heavily loaded as modelled in S-2, Figure 7a shows that while the terminal bus voltage violates throughout the day when no PV is connected, customers connected to the terminal bus experience reduced Undervoltage violations during hours of PV generation with 50% PV penetration levels resulting in no violations for 4.5 h between 10 a.m. and 2 p.m. increasing to 8 h between 8 a.m. and 4 p.m. at 100% PV penetration. The introduction of PV therefore greatly increases the quality of service for these worst-served customers on the feeder when the supply network is heavily loaded.

On the other hand, when the MV supply network is lightly loaded as in S-3, there are no violations at the terminal bus with no PV connected. When PV is added at the terminal bus, overvoltage violations are seen for 2 h from 11 a.m. to 1 p.m. at 50% penetration levels, worsening to 6 h between 9 a.m. and 3 p.m. at 100% penetration levels. PV, therefore, worsens the quality of service for customers connected to the terminal bus, worsening at higher penetration levels. The impact of downstream PV on voltages experienced by customers at the terminal bus depends on the loading conditions of the supply network with beneficial impacts realised when the supply network is heavily loaded and detrimental when lightly loaded. DNOs should consequently encourage PV to be connected at the end of LV feeders in parts of the network that are heavily loaded to reduce the frequency and duration of interruptions, Additionally, PV should be discouraged in parts of the network that are lightly loaded.

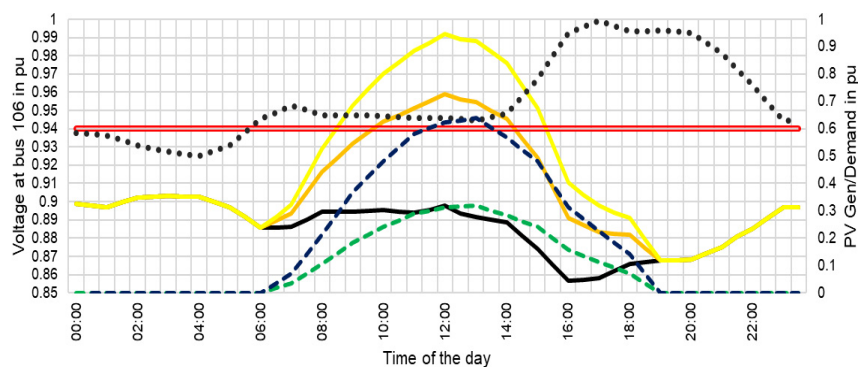

(a) heavily loaded supply network (S-2)

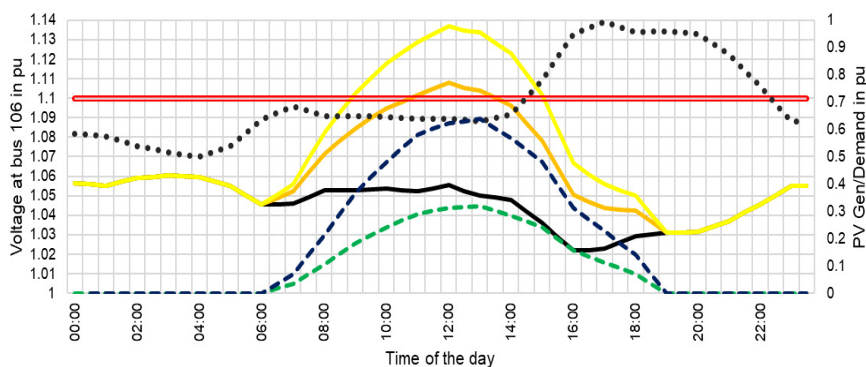

(b) lightly loaded supply network (S-3)

— No DG — 50% Realistic — 100% Realistic — Load — 50% Realistic PV Profile — 100% Realistic PV Profile

Figure 7. Voltages at the terminal bus of the feeder (bus 106) for different PV penetration levels when PV is connected to (a) a heavily loaded supply network (S-2), and (b) a lightly loaded supply network (S-3).

3.5. Effect of the On-Load Tap Changer

As one of the most important aspects of the network's voltage control, it is observed that when the OLTC control in the transformer is set to 'monitor' the bus voltage compliance at the very end of the network, there is a significant improvement in the voltage profile along the feeder, as every time the voltage falls below the threshold, the transformer changes tap thus improving the voltage along the entire circuit. To depict this network behaviour, the PV scenarios when the network is heavily loaded (S-2) are simulated when there is voltage control at the secondary substation and the resulting voltage profiles are shown in Figure 8a–c. The improvement in bus voltages, when OLTC at the secondary transformer leads to better reliability performance as the occurrence and duration of low voltage violations, are reduced in all PV scenarios when compared to Figure 5.

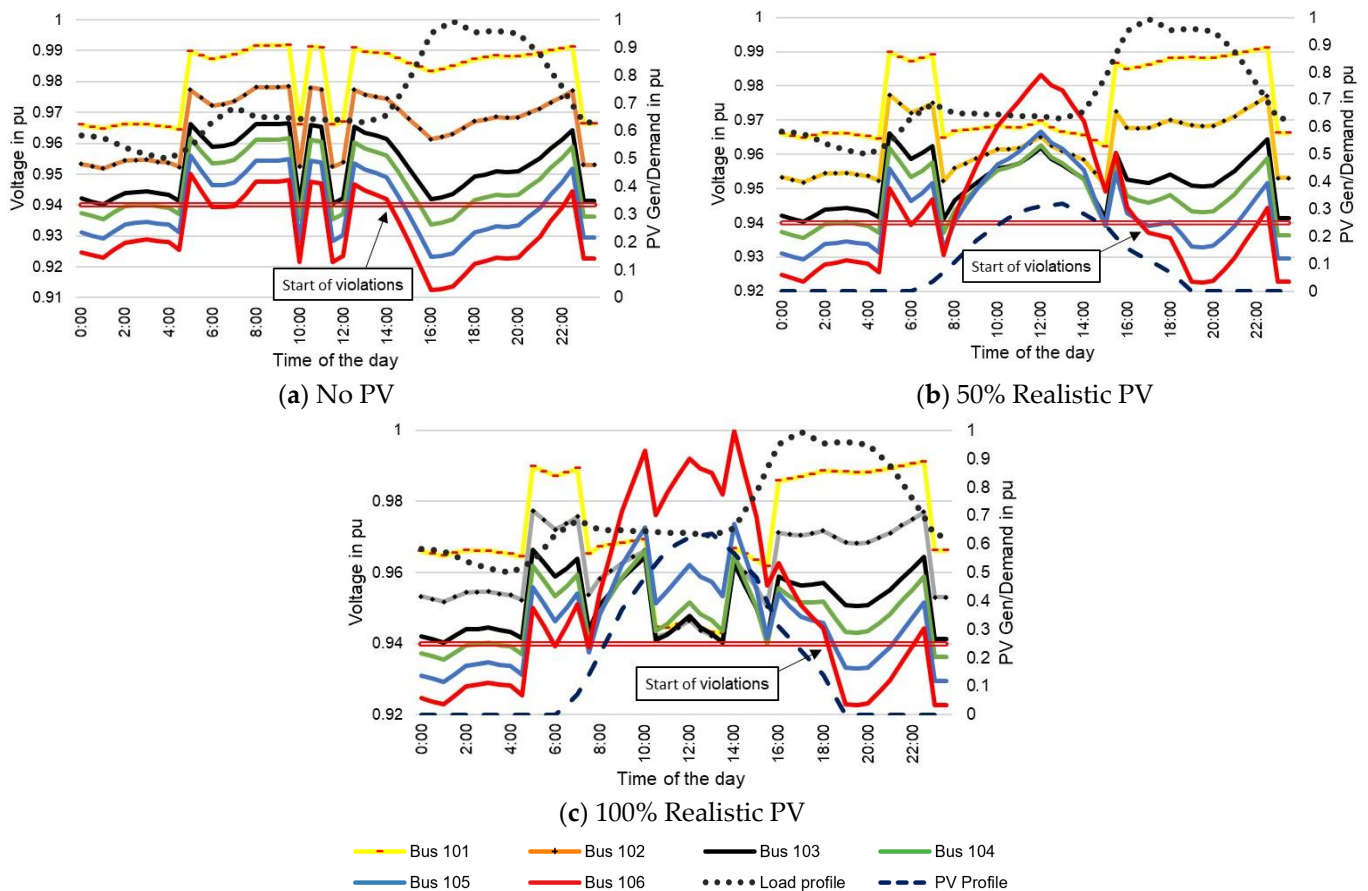

Figure 8. Bus voltages along the feeder connected to a heavily loaded network when OLTC at the secondary transformer is set to control bus 106.

It is observed that when there is no PV connected, the OLTC operates for most of the day by increasing the tap position to restore voltage at bus 100 to 1 pu when the voltage at bus 103 falls below the lower limit of 0.94 pu. There is a significant reduction in the frequency and duration of violations with only buses 104–107 violating between 2 p.m. to 4 a.m. compared to the scenario when the MV supply network is heavily loaded and the OLTC doesn't operate (S-2) when all buses violate throughout the day. The introduction of 50% PV at the end of the feeder further improves the voltages by delaying the start time of the violations at bus 105 and 106 by 3 h, to start at 5 p.m. with violations at bus 104 starting at 11 p.m. all ending at 4 a.m. Moreover, when 100% PV is connected, the start time of the violations at buses 105 and 106 is delayed by a further 4.5 h, to start at 6.30 p.m. with the violations at bus 104 starting at 11 p.m. Therefore, the improvement of bus voltages and consequently the network reliability through OLTC action is complimented by the addition of PV where the most significant impact is observed when the MV supply network is heavily loaded.

4. Conclusions

The analysis in this paper contributes to the important aspects of voltage regulation in LV networks, with increased levels of solar PV penetration, affecting the LV network's PV hosting capacity and quality of supply of customers connected along the feeder. The paper provides a risk and reliability perspective of voltage sensitivity analysis on an LV circuit and its PV hosting capacity at different PV penetration levels and locations by analysing novel voltage-based reliability indices and comparing them with the conventional reliability assessment. Moreover, the LV network is assessed under different loading conditions i.e., light, normal and heavy loading, to further illustrate the impact of PV generation

under different MV supply conditions. The proposed method compliments the standard reliability indices measuring frequency and duration of interruptions, to provide a holistic view of LV network performance and adequately characterise the quality of supply for different customers.

Accordingly, the study concludes that the proposed non-conventional (i.e., voltage-related) reliability in the system improves with higher PV penetration levels, up to a certain limit. Also, the quality of service for the worst-served customers significantly improves when the PV is connected further towards the end of the feeder highlighting the impact of PV placed at different points along the feeder. It is also noted that the loading conditions of the supply network significantly affect the reliability improvement/deterioration accruing from PV being connected on the feeder with all analysed reliability indices reducing (reliability improvement) when the supply network is heavily loaded and increasing accordingly when the supply network is lightly loaded. The impact of the OLTC is also seen to improve reliability across all the indices with the addition of PV further complementing these benefits, more so when the supply network is heavily loaded.

Further work will complement the current state of the art in this work by proposing a techno-economic impact assessment of distributed energy resources (DERs) on the predictive reliability of LV networks. This will consider the economic impact of supply interruptions and propose methods for the deployment of PV that account for the spatial and temporal variation of demand, as well as the impact of PV on the customer voltage based on the loading of the MV supply network. Also, the methodology will employ multilevel Monte-Carlo simulation techniques to investigate PV hosting capacity at more reduced timescales, without affecting the computational complexity and time required. More accurate modelling of typical LV networks incorporating the stochastic nature of PV output and demand profiles in the real network operation can also be done to provide more realistic results.

Author Contributions: Conceptualisation, M.K., I.H.-G. and M.B.N.; methodology, I.H.-G. and M.B.N.; software, M.K.; validation, M.K., I.H.-G. and M.B.N.; formal analysis, M.K.; investigation, M.K., I.H.-G. and M.B.N.; resources, M.K., I.H.-G. and M.B.N.; data curation, M.K.; writing—original draft preparation, M.K. and I.H.-G.; writing—review and editing, M.K., I.H.-G., C.G. and M.B.N.; visualisation, M.K., I.H.-G. and M.B.N.; supervision, I.H.-G. and M.B.N. All authors have read and agreed to the published version of the manuscript.

Funding: This research received no external funding.

Data Availability Statement: No new data were created or analyzed in this study. Data sharing is not applicable to this article.

Acknowledgments: The authors wish to thank the reviewers for their helpful and constructive comments.

Conflicts of Interest: The authors declare no conflict of interest.

References

1. Kisuule, M.; Hernando-Gil, I.; Gu, C.; Ndawula, M.B. Customer Voltage Sensitivity Analysis to Facilitate Reliability and PV Hosting Capacity in LV Networks. In Proceedings of the 13th Mediterranean Conference on Power Generation, Transmission, Distribution and Energy Conversion (MEDPOWER 2022), Hybrid Conference, Valletta, Malta, 7–9 November 2022; pp. 324–329. [\[CrossRef\]](#)
2. Ballanti, A.; Ochoa, L.N.; Bailey, K.; Cox, S. Unlocking New Sources of Flexibility: CLASS: The World's Largest Voltage-Led Load-Management Project. *IEEE Power Energy Mag.* **2017**, *15*, 52–63. [\[CrossRef\]](#)
3. Xavier, R.; Bekker, B.; Chihota, M.J. Smart Inverters in LV networks: A Review of International Codes and Standards, and Opportunities for South Africa. In Proceedings of the 2021 Southern African Universities Power Engineering Conference/Robotics and Mechatronics/Pattern Recognition Association of South Africa (SAUPEC/RobMech/PRASA), Potchefstroom, South Africa, 27–29 January 2021; pp. 1–6. [\[CrossRef\]](#)
4. Cazzato, F.; Di Martino, D.; Di Clerico, M.; Caneponi, G.; Marmeggi, F. The Impact of Distributed Generation on the Italian Distribution Network: Upgrading of Regulatory and Technical Rules in Order to Guarantee and Improve Reliability and Efficiency of the Electrical System. In Proceedings of the 22nd International Conference and Exhibition on Electricity Distribution (CIRED 2013), Stockholm, Sweden, 10–13 June 2013. [\[CrossRef\]](#)

5. BloombergNEF. New Energy Outlook. New York. 2020. Available online: https://assets.bbhub.io/professional/sites/24/928908_NEO2020-Executive-Summary.pdf (accessed on 17 July 2023).
6. Nacmanson, W.J.; Zhu, J.; Ochoa, L.F. Assessing the Unmanaged EV Hosting Capacity of Australian Rural and Urban Distribution Networks. In Proceedings of the CIRED Porto Workshop 2022: E-mobility and Power Distribution Systems, Porto, Portugal, 2–3 June 2022; pp. 681–685. [[CrossRef](#)]
7. Liu, M.Z.; Ochoa, L.F.; Wong, P.K.C.; Theunissen, J. Using OPF-Based Operating Envelopes to Facilitate Residential DER Services. *IEEE Trans. Smart Grid* **2022**, *13*, 4494–4504. [[CrossRef](#)]
8. Dialynas, E.; Hatziargyriou, N. Impact of Microgrids on Service Quality. In Proceedings of the 2007 IEEE Power Engineering Society General Meeting, Tampa, FL, USA, 24–28 June 2007. [[CrossRef](#)]
9. Caldon, R.; Coppo, M.; Raciti, A.; Sgarbossa, R.; Turri, R. Modeling the Control of Islanded Networks Supplied by Inverters: The Case of MV and LV Systems. In Proceedings of the AEIT Annual Conference 2013, Palermo, Italy, 3–5 October 2013. [[CrossRef](#)]
10. Cerretti, A.; D’Orazio, L.; Pezzato, C.; Sapienza, G.; Valvo, G.; Cammalleri, N.; Mattavelli, P.; Sgarbossa, R.; Turri, R.; De Berardinis, E. Uncontrolled Islanding Operations of MV/LV Active Distribution Networks. In Proceedings of the 2015 IEEE Eindhoven PowerTech, Eindhoven, Netherlands, 29 June–2 July 2015. [[CrossRef](#)]
11. Narimani, A.; Nourbakhsh, G.; Ledwich, G. Impact of PV Units in LV Feeders on Distribution System Reliability. In Proceedings of the 2014 Australasian Universities Power Engineering Conference (AUPEC), Perth, WA, Australia, 28 September 2014–1 October 2014; pp. 1–6. [[CrossRef](#)]
12. Collin, A.J.; Hernando-Gil, I.; Acosta, J.L.; Ilie, I.-S.; Djokic, S.Z. Realising the Potential of Smart Grids in LV Networks. Part 2: Microgeneration. In Proceedings of the 2011 2nd IEEE PES International Conference and Exhibition on Innovative Smart Grid Technologies, Manchester, UK, 5–7 December 2011. [[CrossRef](#)]
13. Collin, A.J.; Acosta, J.L.; Hernando-Gil, I.; Djokic, S.Z. An 11 kV Steady State Residential Aggregate Load Model. Part 2: Microgeneration and Demand-Side Management. In Proceedings of the 2011 IEEE Trondheim PowerTech, Trondheim, Norway, 19–23 June 2011; pp. 1–8.
14. Rajabi, A.; Elphick, S.; David, J.; Pors, A.; Robinson, D. Innovative approaches for assessing and enhancing the hosting capacity of PV-rich distribution networks: An Australian perspective. *Renew. Sustain. Energy Rev.* **2022**, *161*, 112365. [[CrossRef](#)]
15. Chihota, M.J.; Bekker, B.; Gaunt, T. A stochastic analytic-probabilistic approach to distributed generation hosting capacity evaluation of active feeders. *Int. J. Electr. Power Energy Syst.* **2021**, *136*, 107598. [[CrossRef](#)]
16. McDermott, T.; Dugan, R. Distributed Generation Impact on Reliability and Power Quality Indices. In Proceedings of the 2002 Rural Electric Power Conference, Papers Presented at the 46th Annual Conference (Cat. No. 02CH37360), Colorado Springs, CO, USA, 5–7 May 2002; p. D3-1. [[CrossRef](#)]
17. Guban, R.C.; McGranaghan, M.F.; Beaty, H.W. *Electric Power Systems Quality*, 2nd ed.; McGraw-Hill: New York, NY, USA, 2002; Volume 1.
18. Wajahat, M.; Khalid, H.A.; Bhutto, G.M.; Bak, C.L. A Comparative Study into Enhancing the PV Penetration Limit of a LV CIGRE Residential Network with Distributed Grid-Tied Single-Phase PV Systems. *Energies* **2019**, *12*, 2964. [[CrossRef](#)]
19. Caire, R.; Retiere, N.; Morin, E.; Fontela, M.; Hadjsaid, N. Voltage Management of Distributed Generation in Distribution Networks. In Proceedings of the 2003 IEEE Power Engineering Society General Meeting, (IEEE Cat. No. 03CH37491), Toronto, ON, Canada, 13–17 July 2003; pp. 282–287. [[CrossRef](#)]
20. Ortmeyer, T. A Unified Index for Power Distribution Reliability/Power Quality Indices. In Proceedings of the 14th International Conference on Harmonics and Quality of Power—ICHQP 2010, Bergamo, Italy, 26–29 September 2010. [[CrossRef](#)]
21. Kisuule, M.; Hernando-Gil, I.; Serugunda, J.; Namaganda-Kiyimba, J.; Ndawula, M.B. Stochastic Planning and Operational Constraint Assessment of System-Customer Power Supply Risks in Electricity Distribution Networks. *Sustainability* **2021**, *13*, 9579. [[CrossRef](#)]
22. Ndawula, M.B.; Zhao, P.; Hernando-Gil, I. Smart Application of Energy Management Systems for Distribution Network Reliability Enhancement. In Proceedings of the 2018 IEEE International Conference on Environment and Electrical Engineering and 2018 IEEE Industrial and Commercial Power Systems Europe (EEEIC/I&CPS Europe), Palermo, Italy, 12–15 June 2018; pp. 1–5. [[CrossRef](#)]
23. Aziz, T.; Ketjoy, N. PV Penetration Limits in Low Voltage Networks and Voltage Variations. *IEEE Access* **2017**, *5*, 16784–16792. [[CrossRef](#)]
24. David, J.; Elphick, S.; Crawford, M. Cause and Effect of Overvoltage on the LV Network. In Proceedings of the 2017 Australasian Universities Power Engineering Conference (AUPEC), Melbourne, VIC, Australia, 19–22 November 2017. [[CrossRef](#)]
25. Tursun, F.; Smiai, M.; Sahin, C.; Gezer, D. Impacts of PV Installation on the Low Voltage Residential Distribution Networks: A Case Study of Yildiz. In Proceedings of the 4th International Conference on Power Engineering, Energy and Electrical Drives, Istanbul, Turkey, 13–17 May 2013; pp. 1415–1420. [[CrossRef](#)]
26. Alam, M.J.E.; Muttaqi, K.M.; Sutanto, D. An Approach for Online Assessment of Rooftop Solar PV Impacts on Low-Voltage Distribution Networks. *IEEE Trans. Sustain. Energy* **2013**, *5*, 663–672. [[CrossRef](#)]
27. Al-Maghalseh, M.; Odeh, S.; Saleh, A. Optimal Sizing and Allocation of DGs for Real Power Loss Reduction and Voltage Profile Improvement in Radial L.V Networks. In Proceedings of the 2017 14th International Conference on Smart Cities: Improving Quality of Life Using ICT & IoT (HONET-ICT), Irbid/Amman, Jordan, 9–11 October 2017; pp. 21–25. [[CrossRef](#)]

28. Demirok, E.; Sera, D.; Teodorescu, R.; Rodriguez, P.; Borup, U. Clustered PV inverters in LV networks: An Overview of Impacts and Comparison of Voltage Control Strategies. In Proceedings of the 2009 IEEE Electrical Power & Energy Conference (EPEC), Montreal, QC, Canada, 22–23 October 2009; pp. 1–6. [[CrossRef](#)]
29. Soltanis, N.L.; Hatziargyriou, N.D. Control Issues of Inverters in the Formation of L. V. Micro-Grids. In Proceedings of the 2007 IEEE Power Engineering Society General Meeting, Tampa, FL, USA, 24–28 June 2007; pp. 1–7. [[CrossRef](#)]
30. Polat, K.; Ozdemir, A.; Delkhooni, M. Reliability Analysis in Low Voltage Distribution Network with Peer to Peer Energy Trading. In Proceedings of the 2021 IEEE Madrid PowerTech, Madrid, Spain, 28 June–2 July 2021; pp. 1–6. [[CrossRef](#)]
31. Mohammadi, P.; Mehraeen, S. Challenges of PV Integration in Low-Voltage Secondary Networks. *IEEE Trans. Power Deliv.* **2016**, *32*, 525–535. [[CrossRef](#)]
32. Hoke, A.; Butler, R.; Hambrick, J.; Kroposki, B. Steady-State Analysis of Maximum Photovoltaic Penetration Levels on Typical Distribution Feeders. *IEEE Trans. Sustain. Energy* **2012**, *4*, 350–357. [[CrossRef](#)]
33. Brooks, D.; Dugan, R.; Waclawiak, M.; Sundaram, A. Indices for assessing utility distribution system RMS variation performance. *IEEE Trans. Power Deliv.* **1998**, *13*, 254–259. [[CrossRef](#)]
34. Hernando-Gil, I.; Shi, H.; Li, F.; Djokic, S.; Lehtonen, M. Evaluation of Fault Levels and Power Supply Network Impedances in 230/400V 50Hz Generic Distribution Systems. *IEEE Trans. Power Delivery* **2017**, *32*, 768–777. [[CrossRef](#)]
35. EN 50160; Voltage Characteristics of Electricity Supplied by Public Distribution Systems. European Standard, CENELEC: Brussels, Belgium, 2005; pp. 1–20. Available online: <https://powerquality.blog/2021/07/22/standard-en-50160-voltage-characteristics-of-public-distribution-systems/> (accessed on 6 August 2023).
36. Long, C.; Ochoa, L.F. Voltage Control of PV-Rich LV Networks: OLTC-Fitted Transformer and Capacitor Banks. *IEEE Trans. Power Syst.* **2015**, *31*, 4016–4025. [[CrossRef](#)]

Disclaimer/Publisher’s Note: The statements, opinions and data contained in all publications are solely those of the individual author(s) and contributor(s) and not of MDPI and/or the editor(s). MDPI and/or the editor(s) disclaim responsibility for any injury to people or property resulting from any ideas, methods, instructions or products referred to in the content.