



**HAL**  
open science

## Emotion in action: When emotions meet motor circuits

Anaëlle Braine, François Georges

► **To cite this version:**

Anaëlle Braine, François Georges. Emotion in action: When emotions meet motor circuits. *Neuroscience and Biobehavioral Reviews*, 2023, 155, pp.105475. 10.1016/j.neubiorev.2023.105475 . hal-04311811

**HAL Id: hal-04311811**

**<https://hal.science/hal-04311811>**

Submitted on 28 Nov 2023

**HAL** is a multi-disciplinary open access archive for the deposit and dissemination of scientific research documents, whether they are published or not. The documents may come from teaching and research institutions in France or abroad, or from public or private research centers.

L'archive ouverte pluridisciplinaire **HAL**, est destinée au dépôt et à la diffusion de documents scientifiques de niveau recherche, publiés ou non, émanant des établissements d'enseignement et de recherche français ou étrangers, des laboratoires publics ou privés.



## Emotion in action: When emotions meet motor circuits

Anaëlle Braine, François Georges<sup>\*</sup>

Univ. Bordeaux, CNRS, IMN, UMR 5293, F-33000 Bordeaux, France

### ARTICLE INFO

#### Keywords:

Brain  
Neuronal circuits  
Emotional states  
Movement  
Limbic system  
Basal ganglia  
Motor system  
Motor behavior  
Neuromodulators  
Sensory-motor control

### ABSTRACT

The brain is a remarkably complex organ responsible for a wide range of functions, including the modulation of emotional states and movement. Neuronal circuits are believed to play a crucial role in integrating sensory, cognitive, and emotional information to ultimately guide motor behavior. Over the years, numerous studies employing diverse techniques such as electrophysiology, imaging, and optogenetics have revealed a complex network of neural circuits involved in the regulation of emotional or motor processes. Emotions can exert a substantial influence on motor performance, encompassing both everyday activities and pathological conditions. The aim of this review is to explore how emotional states can shape movements by connecting the neural circuits for emotional processing to motor neural circuits. We first provide a comprehensive overview of the impact of different emotional states on motor control in humans and rodents. In line with behavioral studies, we set out to identify emotion-related structures capable of modulating motor output, behaviorally and anatomically. Neuronal circuits involved in emotional processing are extensively connected to the motor system. These circuits can drive emotional behavior, essential for survival, but can also continuously shape ongoing movement. In summary, the investigation of the intricate relationship between emotion and movement offers valuable insights into human behavior, including opportunities to enhance performance, and holds promise for improving mental and physical health. This review integrates findings from multiple scientific approaches, including anatomical tracing, circuit-based dissection, and behavioral studies, conducted in both animal and human subjects. By incorporating these different methodologies, we aim to present a comprehensive overview of the current understanding of the emotional modulation of movement in both physiological and pathological conditions.

### 1. Introduction

Human beings are constantly in motion. Our capacity to generate adaptive and efficient movements in a continuous manner is crucial for everyday tasks (i.e., being able to move to one place or grab a cup of water) and is also a major mode of communication (Pezzulo et al., 2019; Schwartz, 2016). A large body of the Neuroscientific literature has focused on the challenging question of how the brain controls movement (Schwartz, 2016; Kandel et al., 2021). The significant advances in the motor field cover a multitude of discoveries such as pinpointing relevant activity patterns, neurotransmitters, brain structure and circuits (Arber and Costa, 2022) involved in the control of movement. These discoveries are not only important for academic research but also necessary for the development of clinical treatments for patients with brain-derived motor dysfunctions (Tanner and Ostrem, 2020). Nonetheless, we are still far from a complete and detailed picture of how the brain controls and refines voluntary movements, nor can we be satisfied with the current available treatments (Dayalu and Albin, 2015; Armstrong and

Okun, 2020).

Our movements are far from being an independent process and are modulated by different factors (Proske and Gandevia, 2012; Glickstein, 2000; Berlot et al., 2021), including our emotions. It is widely accepted that emotions can drive strong and fast whole-body motor responses (e.g., run or freeze), and have control over facial and bodily expressions. However, the influence of emotions on motor actions encompasses what can be referred to as “survival responses” or emotional expression. What about when our primary intent is to grab a cup, drive or just walk somewhere and we just had a very bad day or very exciting news? Chances are that you might drop the cup or hit it on your teeth, stall once or twice, or trip. Even on learnt skilled movements, such as dance choreographies, it is not uncommon that performers enhance or decrease their performance on the day of the representation.

This area of study is of clinical importance as there is a strong relationship between motor disorders and psychiatric disorders (Cummins et al., 2015). For most movement disorders, while the most prominent features are related to motor dysfunction, there has been an emerging consensus that many motor pathologies have very debilitating

<sup>\*</sup> Corresponding author.

E-mail address: [francois.georges@bordeaux.fr](mailto:francois.georges@bordeaux.fr) (F. Georges).

**Abbreviations***Brain structures*

<b>M1</b>	Motor Cortex
<b>DS</b>	Dorsal Striatum
<b>DMS</b>	Dorsomedial Striatum
<b>DLS</b>	Dorsolateral Striatum
<b>GPe</b>	Globus Pallidus, <i>pars externa</i>
<b>GPi</b>	Globus Pallidus, <i>pars interna</i>
<b>SN</b>	Substantia Nigra
<b>SNr</b>	Substantia Nigra, <i>pars reticulata</i>
<b>SNC</b>	Substantia nigra, <i>pars compacta</i>
<b>BLA</b>	Basolateral Amygdala
<b>Cg</b>	Cingulate Cortex
<b>IC</b>	Insular Cortex
<b>OFC</b>	Orbitofrontal Cortex
<b>mPFC</b>	medial Prefrontal Cortex
<b>IL</b>	Infralimbic Cortex
<b>PL</b>	Prelimbic Cortex
<b>VP</b>	Ventral Pallidum
<b>LS</b>	Lateral Septum
<b>CeA</b>	Central Amygdala
<b>BNST</b>	Bed Nucleus of the stria terminalis
<b>NAc</b>	Nucleus Accumbens
<b>DRN</b>	Dorsal Raphe Nucleus
<b>VTA</b>	Ventral Tegmental Area
<b>LC</b>	Locus Coeruleus
<b>STN</b>	Subthalamic Nucleus
<b>LH</b>	Lateral Hypothalamus
<b>PVN</b>	Paraventricular Hypothalamic Nucleus
<b>vHPC</b>	ventral Hippocampus
<b>PVT</b>	Paraventricular Thalamus
<b>GRN</b>	Gigantocellular reticular nucleus
<b>LGRN</b>	Lateral Gigantocellular reticular nucleus
<i>Neurotransmission-related</i>	
<b>CRF/CRH</b>	Corticotropin Releasing Factor/Hormone
<b>ChAT</b>	choline acetyltransferase
<b>CaMKII</b>	Calcium-calmodulin-dependent protein kinase II
<b>vGlut</b>	Vesicular glutamate transporter
<b>vGat</b>	Vesicular GABA transporter
<b>SERT</b>	Serotonin Transporter
<b>DAT</b>	Dopamine Transporter
<b>Gabbr3</b>	Gamma-Aminobutyric Acid Type A Receptor Subunit Rho3
<b>Gad</b>	Glutamate Decarboxylase
<b>PV</b>	Parvalbumin
<b>Rbp4</b>	Retinol-binding protein 4
<b>Oxt</b>	Oxytocin

<b>AVP</b>	Arginine Vasopressin
<b>SST</b>	Somatostatin
<b>NTS</b>	Neurotensin
<b>Mc3R</b>	Melanocortin 3 Receptor
<b>Penk</b>	Proenkephalin
<b>NA</b>	Noradrenaline
<b>5-HT</b>	5-hydroxytryptamine
<b>DA</b>	Dopamine
<b>TH</b>	Tyrosine Hydroxylase
<b>CORT</b>	Corticosterone

*Tracers*

<b>A</b>	Anterograde
<b>R</b>	Retrograde
<b>HRP</b>	Horseradish Peroxidase
<b>WGA</b>	Wheat Germ Agglutinin
<b>CTb</b>	Cholera toxin-b
<b>FG</b>	FluoroGold
<b>rAAV</b>	retro-Adeno-Associated Virus
<b>AAV</b>	Adeno-Associated Virus
<b>PHA-L</b>	Phaseolus vulgaris-leucoagglutinin
<b>BDA</b>	Biotinylated dextran amines

*Human & rodent behavioral tests*

<b>MAS</b>	Manifest Anxiety Scale
<b>STAI</b>	State-Trait Anxiety Inventory
<b>IAPS</b>	International Affective Picture System
<b>MRF</b>	Mental Readiness Form
<b>SAM</b>	Self-Assessment Manikin
<b>SSRs</b>	Multiple Subject Stress Ratings
<b>ECG</b>	Electrocardiogram
<b>HAM-A</b>	Hamilton Anxiety Rating Scale
<b>CCEI</b>	Crown-Crisp experiential index
<b>SCL-90</b>	Symptom Checklist 90
<b>L/D box</b>	Light/Dark box
<b>EPM</b>	Elevated-Plus Maze
<b>RS</b>	Restrain Stress
<b>CSDS</b>	Chronic Social Defeat Stress
<b>CVS</b>	Chronic Variable Stress
<b>MABC</b>	Motor Assessment Battery for Children
<b>UPDRS</b>	Unified Parkinson's Disease Rating Scale
<b>PD</b>	Parkinson's Disease
<b>PANAS</b>	Positive and Negative Affect Schedule
<b>MINI</b>	Mini International Neuropsychiatric Interview Plus Version
<b>K-SADS PL</b>	Kiddie-Schedule for Affective Disorders and Schizophrenia, Present and Lifetime Version

non-motor symptoms, which include neuropsychiatric symptoms such as anxiety (Chaudhuri et al., 2006; Roos, 2010; Hirschtritt et al., 2015) or deficiencies in recognizing emotions (Henley et al., 2012; Argaud et al., 2018). More importantly, these neuropsychiatric symptoms may aggravate (Ehgoetz Martens et al., 2018; Dissanayaka et al., 2010) or be a part of the pathophysiology (Martínez-Martín and Damián, 2010) of motor disorders.

The existence of psychogenic movement disorders further highlights the connection between psychic state and motor disorders as they are defined (Peckham and Hallett, 2009) as “movement disorders caused by an abnormal psychiatric state, rather than an organic disorder of the nervous system”. This is further illustrated by the frequent motor dysfunctions in psychiatric disorders, discussed in (Perju-Dumbrava and Kempster, 2020), which closely resemble those of movement disorders

such as Parkinson's Disease (PD). One striking example of this would be catatonia, which has raised much debate on its motor or affective prominent origin (Hirjak et al., 2022). It is currently classified as a neuropsychiatric disorder and often occurs in affective disorders (Abrams and Taylor, 1976), but its primary diagnosis is based on the observation of motor symptoms (Perju-Dumbrava and Kempster, 2020). Authors have raised the similarities of those symptoms such as postural abnormalities to those observed in basal ganglia motor disorders (Perju-Dumbrava and Kempster, 2020; Hirjak et al., 2022).

Previous reviews on the subject have highlighted the role of stress on motor control and elegantly described the different ways through which the hormonal response to stress could impact motor circuits and function (Metz, 2007). The goal of this review is to provide an overview of the current state of knowledge in this rapidly evolving field. To better

define the impact of emotional control on motor output, we conducted a comprehensive narrative review of behavioral evidence assessing the effect of emotional state on motor performance. We report a variety of factors including walking speed, postural stability, hand-eye coordination, manual dexterity, fine motor skills and balance during different emotional states in humans and rodents, in normal and pathological conditions.

To comprehend how these two systems interact, previous studies have investigated the neural basis of emotion to motor interaction. Neuronal circuits are thought to play a crucial role in integrating sensory, cognitive, and emotional information to ultimately guide behavior. Neural circuits underlying the emotion-motor interface have classically been assigned to the Nucleus Accumbens (NAc), based on its capacity to generate locomotor and oral motor responses and its connectivity, with inputs from various emotion-related areas such as the Amygdala, and outputs to the structures of the motor system (Mogenson et al., 1980). However, this view has been challenged over the years with many reports of other direct emotion-to-motor anatomical connections (Hunt et al., 2018a; Smith et al., 2016; Cregg et al., 2020). In line with this idea, functional neuroimaging studies in humans during self-generated emotions could display significant activity changes in motor-related structures (Damasio et al., 2000). Importantly, both structural (Husain et al., 1991; Groenewold et al., 2023) and functional (Klumpp et al., 2012, 2010; Stuhmann et al., 2011; Xia et al., 2022; Zhang et al., 2023; Heitmann et al., 2016) alterations of motor-related structures or sensorimotor networks have been reported in pathologies with dysfunctional emotional processing such as major depressive disorder or anxiety disorders. The goal of this review is to expand the neural basis of emotion to motor connectivity. We provide a comprehensive connectivity map of the direct anatomical emotion to motor reported projections and we shed light on neural circuits to explore or that require further clarification. We hope this will encourage researchers of the emotion- and motor- field to provide additional anatomical details on specific circuits with respectively their collaterals and their inputs. Furthermore, this should encourage the exploration of these circuits and associated function, both in physiological and pathological conditions.

For this purpose, we first compiled an exhaustive list of emotion- and motion-related structures. Over the years, studies using a variety of techniques, including electrophysiology, imaging, and optogenetics, have revealed a complex network of neural circuits involved in the regulation of emotional (Tovote et al., 2015; Xia and Kheirbek, 2020; Berridge and Kringelbach, 2015) and motor processes (Arber and Costa, 2022). Research has also highlighted the role of neuromodulatory systems, such as serotonin, dopamine (DA), and noradrenaline (NA), in modulating the activity of these circuits and influencing motor or emotional processes (Likhnik and Johansen, 2019; Conio et al., 2020; Speranza et al., 2021; Bacqué-Cazenave et al., 2020; Delaville et al., 2011).

To gain insight on the capacity of an emotion-related structure to drive or modulate motor behavior, we searched for evidence of motor-related effects following manipulation of the activity of emotion-related structures. Most studies manipulating emotion-related structure do not consistently provide basic reports of locomotor activity or gross motor-coordination, though many exceptions exist.

Though not the subject of this review, there is a growing body of evidence suggesting that many brain structures traditionally associated with motor functions also play a role in mediating emotional behaviors (Sztainberg et al., 2011; Révy et al., 2014). Thus, it would not be surprising if some of the emotion-to-motor connections we describe might be more closely associated with emotional aspects of behavior rather than purely motor ones. We thus hope that future research investigating those circuits will pay attention to both components, as there is a strong need to clarify the contribution of these circuits and structures in both the motor and emotional fields.

More importantly, examination of these circuits should help the comprehension of the neural basis for the pathophysiology of non-motor

symptoms in motor disorders, as well as the emergence of motor symptoms in psychiatric conditions. Such exploration could also contribute to a clearer distinction regarding the impacts of treatments on motor and non-motor symptoms within various disorders. For example, the role of the serotonergic Dorsal Raphe Nucleus (DRN) projections to the substantia nigra, *pars compacta* (SNc) have been mentioned as a possible explanatory mechanism for motor symptoms of catatonia (Hirjak et al., 2022), and the general understanding of DRN projections and circuits have been heavily used to understand the role of serotonin and selective serotonin reuptake inhibitor (SSRIs) in PD (Fox et al., 2009).

In conclusion, this narrative review on the emotional modulation of movement is separated into two main parts. The first is focused on the behavioral evidence for the emotional modulation of movement in humans and rodents and its implication in pathologies. The second part is aimed at exploring the neural basis for emotion-to motor modulation using a neural circuit approach in murine. We conducted a narrative but exhaustive search for anatomical evidence of direct projections, or lack of direct projections between 16 relevant emotion-related to 9 motor-related brain structures. We further searched for behavioral evidence for these emotion-related structures to drive or modulate movement, though much remains to be done in that regard. We highlighted the anatomical connections that would require further anatomical grounds and discussed the putative functions of some main emotion-to-motor pathways. This review aims to shed light on brain structures and neural networks involved in the emotional modulation of movement, and to provide a strong foundation for further research on this topic.

## 2. Materials and methods

We conducted a narrative review on the intricate interplay between emotions and movements, searching the database Pubmed and Google Scholar for the following terms: Anterograde, Retrograde, Anatomy, Efference, Afference, Outputs, Inputs, Circuit, Emotions, State, Mood, Anxiety, Stress, Motor, Movement, Rotarod, Motor Skilled reaching, Motor skilled forelimb, Coordination, Direction, Orientation, Optogenetics, Rabies, Chemogenetics, Lesions, Manipulation. All the structures have been individually searched with all those terms. We also searched for all individual projections, creating emotion-motor pairs of the 16 emotion-related structures with the 13 motor-related structures. A large number of articles have been further included using references in articles or when investigating the organization and motor function of motor-related structures.

We used the following inclusion criteria:

For behavioral studies (Table 1), studies were required to specifically test motor behavior with observations or interventions on emotional states. Both positive and negative results were included.

For the anatomical studies (Table 2), were included only studies on mice and rats. We included only monosynaptic tracing studies. All available studies until July 2023 were included for review with no minimum sample size set. Both positive and negative results were included. To report negative results, either the study explicitly mentioned the lack of labeling, or we determined whether the study had done extensive mapping of the anterograde or retrograde labeling near the regions of interest (cortical, midbrain or brainstem area).

The main difficulty in summarizing the anatomical results was to adapt to the evolution of the anatomical terms for similar or overlapping structures, between atlases, within versions, abbreviations and the fine-to-coarse hierarchy in the naming of structures. Finding a common framework for anatomical labeling and coordinates of murine brain atlases is the subject of many recent articles (Chon et al., 2019) and reviews (Kleven et al., 2023; Azimi et al., 2017). Nonetheless, most of the brain structures investigated here have similar location and naming between the two most commonly used 2D atlases of the murine brain, namely the Franklin-Paxinos Atlas and the Allen Reference Atlas. The main discrepancy found was between the ventral pallidum (VP), which,

**Table 1**  
Impact of emotional states on motor performances.

Subjects	Anxiety	Motor task	Conclusions	ref
<b>a. Humans</b>				
Students (M, n = 200)	- Trait anxiety - State anxiety: Presence of evaluators	Simple repetitive motor task	Inverted U-hypothesis: High trait anxiety performed better than low when no stressor. The presence of a stressor had opposite effects on group performance.	(Cox, 1968)
Students (M, n = 90)	- Trait anxiety (MAS)	Hand skilled movement	Inverted U-hypothesis: Low and high trait and state anxiety performed worse than moderate trait and state anxiety.	(Martens and Landers, 1970)
Students (NA, n = 640)	- State anxiety: Threat of a shock - Trait anxiety (MAS)	Pursuit-rotor test: Hand and eye coordination	Trait anxiety was negatively correlated with performance at all time points.	(Jones and Tallarico, 1971)
Adults (M/W, n = 40)	- Trait anxiety (STAI) - State anxiety: Public evaluation	Gross arm & fine hand movements movement	U-inverted hypothesis for fine motor task: High anxiety profiles performed better in non-stress than the low anxiety profiles and worse in stressful condition. Low anxiety profiles had opposite results.	(Calvo and Alamo, 1987)
Adults (M/W, n = 20)	- State and Trait anxiety (Japanese STAI)	Postural sway: Balance control.	Basal anxiety states were positively correlated with changes in postural body sway causing instability. This effect was abolished if eyes were closed.	(Ohno et al., 2004)
Adults (M, n = 24)	- Competitive state anxiety (MRF): Ego threat	Driving task: hand, feet and eye coordination	State anxiety impaired eye-steering coordination, performance.	(Wilson et al., 2008)
Pianist (M/W, n = 18)	- State anxiety: Professional judges and large audience	Solo piano piece: Fine finger movements and coordination	State anxiety impaired performance (tempo, dexterity) and was associated with a persistent low-level muscle tension arm and shoulder.	(Yoshie et al., 2009)
Trained soldiers (M, n = 32)	- Trait anxiety (STAI) - State anxiety- Arousal: Urban combat simulation	Loading bullet in gun: Fine motor skill	Soldiers improved their performance post-simulation. However, the simulation increased their arousal but not their state anxiety. Possible U-inverted hypothesis.	(Sánchez-Molina et al., 2018)
<b>b. Rodents</b>				
Rats (M, n = 8)	- Acute stress: RS	<u>Locomotion</u>	Acute stress, increased vertical and horizontal activity with no change in speed.	(Casada and Dafny, 1991)
Rats (M, n = 16)	- Acute & chronic (13d) stress: Forced swimming, L/D box	<u>Balance/Coordination:</u> Ladder beam <u>Strength:</u> Grip test <u>Skilled Walking:</u> Sticky paper	Acute and chronic stress induced deficits in ladder beam (foot falls), increased grip duration and skilled walking.	(Metz et al., 2001)
Mice (M/F, n = 54)	- Anxiety (L/D box, EPM, Inescapable swim test) - Stress: CRH overexpression - Conditioned fear	<u>Spontaneous behavior:</u> Open field <u>Balance/Coordination:</u> Rotarod	Decreased spontaneous locomotion, decreased time spent on the rotarod, with little or no improvements over time. Anxiety-like behavior in some but not all tests.	(Van Gaalen et al., 2002)
Rats (M, n = 142)	- Acute & chronic (4w) stress: Forced swimming - Antidepressants: Trazodone	<u>Balance/Coordination:</u> Rotarod <u>Strength:</u> Traction Test <u>Locomotion</u>	Rotarod performance was impaired in in chronically stressed rats, even following a 10-day recovery period. High doses of antidepressants reversed this effect. Strength and locomotion did not differ in chronic stress conditions.	(Mizoguchi et al., 2002)
Mice, (M, n = 103)	- Differences in strain basal anxiety levels - Anxiolytic/Anxiogenic: Diazepam / b-CCM	<u>Balance/Coordination:</u> - Holeboard test - Rotating beam <u>Strength:</u> Grip test	C mice (Anxious strain) had an impaired posture and balance vs B6. Diazepam and b-CCM respectively improved or impaired balance and posture in both strains.	(Lepicard et al., 2003)
Rats, (F, n = 76)	- Acute & chronic (15d) stress: CORT, Forced swimming, RS - Anxiolytic: Diazepam	<u>Fine motor skills:</u> - Skilled forelimb reaching task - Skilled walking task	Both acute and chronic stress impaired skilled movements. Diazepam improved skilled movement with a dose-response following a U-inverted curve.	(Metz et al., 2005)
Rats, 6-OHDA lesion, (F, n = 16)	- Anxiolytic: Enriched environment housing (EE)	<u>Fine motor skills:</u> - Skilled forelimb reaching task - Skilled walking task	Pre-lesion, EE improved skilled limb movement accuracy. Post-lesion (with delay): EE improved recovery in skilled limb movement accuracy and limb placement accuracy	(Jadavji et al., 2006)
Rats, (M/F, n = 20)	- Acute & chronic (15d) stress: RS	<u>Fine motor skills:</u> - Skilled forelimb reaching task - Skilled walking task	Acute and chronic stress impaired skilled forelimb reaching task. Males were more sensitive and recovered more slowly to stress-induced impairments. No correlation with CORT levels.	(Jadavji and Metz, 2008)
Rats, (M, n = 78)	- Acute & chronic (15d) stress: RS	<u>Fine motor skills:</u> Skilled forelimb reaching task	Acute and chronic stress impaired the skilled forelimb reaching task. No correlation with CORT levels.	(Kirkland et al., 2008)
Mice, (M, n = 21)	- Chronic (7d) stress: RS	<u>Locomotion</u>	Chronic stress induced hyper-locomotion (increased distance travelled).	(Ito et al., 2010)
Mice, (M/F, n = 18)	- Acute & chronic (15d) stress: Glucocorticoids	<u>Balance/Coordination:</u> Rotarod	Chronic administration of glucocorticoid impaired rotarod performance while acute administration had bi-directional effects on performance, following a U-inverted hypothesis.	(Liston et al., 2013)
Mice, (M/F, n = 27)	- Acute & chronic (8w) stress: RS	<u>Balance/Coordination:</u> Rotarod <u>Locomotion</u>	Restrain stress improved performance on rotarod and induced hyperlocomotion in males but not females.	(Mo et al., 2014)
Mice, (M, n = 30)	- Acute stress: CORT	<u>Balance/Coordination:</u> - Beam test - Coat hanger test - Rotarod	CORT impaired performances on rotarod and coat hanger test.	(Harlé et al., 2017)
Mice, (M, n = 21)	- Chronic stress: CSDS	<u>Balance/Coordination:</u> Rotarod	CSDS induced hypo-locomotion but no impairments on rotarod or grip test.	(He et al., 2021)

(continued on next page)

Table 1 (continued)

Subjects	Anxiety	Motor task	Conclusions	ref
Mice, (M, n = 54)	- Chronic stress: CSDS	<u>Locomotion</u> <u>Strength</u> : Grip test <u>Balance/Coordination</u> : Rotarod <u>Fine motor skills</u> : Skill reaching test	Stress impaired fine motor movement acquisition in all groups. Stress improved rotarod motor learning in “resilient” and impaired performance in “susceptible” mice.	(Gellner et al., 2022)
<b>c. Pathological conditions</b>				
PD, (M/W, n = 6)	- Stress, anxiety, embarrassment, tension reports	Walking, Grip strength Voluntary movement	Practicians reported strong motor improvements or impairments following a strong emotional event with no change in treatment. These effects could be long lasting.	(Schwab and Zieper, 1965)
PD, (M/W, n = 392)	- Presence of psychiatric disorder: Medical records, DSM-5, physician diagnosis	Diagnosis of PD	Retrospective study: Significant association between the presence of anxiety disorders and PD, whether they started 5,10 or 20 years before the motor symptoms.	(Shiba et al., 2000)
PD (M/W, n = 79)	- Anxiety disorders (MINI)	Hoehn and Yahr Staging of PD UPDRS	Severity of motor symptoms and treatment complications (on/off fluctuation) were associated with the presence of an anxiety disorder.	(Dissanayaka et al., 2010)
PD (M/W, n = 30)	- Trait anxiety (STAI) - State anxiety: Postural threat, - Affective state (PANAS)	Posture UPDRS	Anxiety state and fear scores were correlated with changes in postural control, affecting static balance. These changes were similar across groups.	(Pasman et al., 2011)
PD (M/W, n = 70)	- Trait anxiety (STAI)	Walking gait UPDRS	High trait anxiety parkinsonians walked with slower gait, reduced step length and increased variability in comparison to both the control and low anxiety PD group.	(Ehgoetz Martens et al., 2018)
Mice PD-like (MPTP) (M/F, N = 40)	- Chronic stress: RS	<u>Balance/Coordination</u> : Rotarod	Chronic RS + MPTP worsened rotarod performance and motor skill learning compared to MPTP only.	(Lauretti et al., 2016)
Rats PD-like (6-OHDA) (F, n = 24)	- Chronic stress: RS or CORT	<u>Fine motor skills</u> : Skill reaching test	RS and CORT impaired skilled reaching success pre-6-OHDA lesions and post-6-OHDA lesion	(Smith et al., 2008)
Rats PD-like (6-OHDA) (M, n = 30)	- Chronic stress: CVS	<u>Forelimb asymmetry</u> : Cylinder test	CVS increased forelimb asymmetry in 6-OHDA condition	(Hemmerle et al., 2014)
Essential tremors, (M/W, n = 74)	- Severity of anxiety: HAM-A	Tremor disability questionnaire & video examination Performance test	Anxiety (and depression) were associated with greater self-reported disability and with greater difficulty in performance-based test.	(Louis et al., 2001)
Health professionals, (M, n = 35 815)	- Personality traits and phobic anxiety (CCEI)	Diagnosis of PD	Prospective study: Men with the highest levels of anxiety had significantly increased risk (1.5) to develop PD than men with the lowest anxiety in a 12 year follow up study.	(Weiskopf et al., 2003)
Musicians with focal dystonia (M/W, n = 50)	- Presence and timing of anxiety symptoms: Self estimation test	Presence of task-related dystonia	Retrospective study: Social and specific phobias were higher in musicians with focal dystonia before and after its onset.	(Jabusch and Altenmüller, 2014)
Essential Tremors (M/W, n = 162)	- Psychological symptoms (SCL-90)	Tremor scoring on five activities*	The prevalence of anxiety, phobic anxiety and psychoticism was higher in essential tremor patients. The severity, but not the duration of the disease was correlated with the severity of anxiety symptoms.	(Tan et al., 2005)
Children with Anxiety disorders (M/W, n = 54)	- Non-comorbid “pure” anxiety disorder (DSM-V, K-SADS PL)	Manual dexterity, Ball skill, Static and Dynamic balance (MABC)	Boys but not girls with an anxiety disorder had significantly greater motor skill impairments than the control group. More than 2/3rd of the anxious boys had motor problems according to MABC score.	(Ekornås et al., 2010)

Abbreviations: MAS: Manifest Anxiety Scale; STAI: State-Trait Anxiety Inventory; IAPS: International Affective Picture System; MRF: Mental Readiness Form; SAM: Self-Assessment Manikin; SSRs: Multiple Subject Stress Ratings; ECG: Electrocardiogram; HAM-A: Hamilton Anxiety Rating Scale; CCEI: Crown-Crisp experiential index; SCL-90: Symptom Checklist 90; L/D box: Light/Dark box; EPM: Elevated-Plus Maze; RS: Restrain Stress; CSDS: Chronic Social Defeat Stress; CVS: Chronic Variable Stress; CRF: Corticotropin Releasing Factor; CORT: Corticosterone; MABC: Motor Assessment Battery for Children; UPDRS: Unified Parkinson’s Disease Rating Scale; PD: Parkinson’s Disease; PANAS: Positive and Negative Affect Schedule; MINI: Mini International Neuropsychiatric Interview Plus Version; K-SADS PL: Kiddie-Schedule for Affective Disorders and Schizophrenia; Present and Lifetime Version; MPTP: 1-methyl-4-phenyl-1,2,3,6-tetrahydropyridine; 6-OHDA: 6-hydroxydopamine; b-CCM: methyl  $\beta$ -carboline-3-carboxylate; EE: Enriched environment; DSM-5: Diagnostic and Statistical Manual of Mental Disorders, Fifth Edition; M: Males/Man; F: Females; W: Woman.

in the Franklin-Paxinos atlas is separated from the substantia innominata, while in the Allen Reference Atlas, the ventral region of the Pallidum is composed of the substantia innominata and the magnocellular nucleus. In this review, the VP is related to the nomenclature used by the Franklin-Paxinos Atlas and excluded the substantia innominata and the magnocellular nucleus.

Furthermore, though it is becoming increasingly common to automatize the mapping and labeling of brain sections, the delimitation and naming of structures is, for the most part, determined manually by the experimenter (Bjerke et al., 2018). Thus, even articles using the same atlas may not define similar boundaries for a given structure. Thus, we did not differentiate structure naming in relation to the year, version or atlas used in the different articles. To be comprehensive but avoid structure naming confounds, when we had a doubt in the terminology of the structures (Fig. 4, names followed by an asterisk \*), we assessed the

localization of the labeling or injection when possible. For example, the ventral striatum (VS) includes the NAc and the olfactory tubercle. Nonetheless, authors often use the VS as a synonym for the NAc. Similarly, the “Amygdala” often refers to the Basolateral (BLA) or Central Amygdala (CeA), though not always. If the naming was too ambiguous, and images could not provide convincing details on the subregions labeled, we did not include the article for the given structure. However, if the labeling observed on provided images were considered sufficient to clarify the ambiguity, it was included in Table 2.

In addition, some of the structures we investigated have functional relevance but unclear anatomical boundaries or naming in the literature. This was the case for the ventral hippocampus (vHPC) and medial prefrontal cortex (mPFC). The hippocampus has been functionally subdivided into its most dorsal and ventral regions (Fanselow and Dong, 2010; Floriou-Servou et al., 2018), though these differentiations do not

**Table 2**  
Review of the anatomical projections from emotion-related structures to the motor system.

OFC	A/R	Tracer	Rodent	Transgenic line & References	
M1	✓	R	Cre-dpt rabies	Mouse	CRF-cre (Zhao et al., 2020), Thy1-cre, vGat-cre (Luo et al., 2019), Rbp4-cre (Geng et al., 2022)
	✓	A	PHA-L	Mouse	(Hoover and Vertes, 2011)
	✓	A	AAV	Mouse	(Gao et al., 2022; Wang et al., 2021)
DS	✓	R	Cre-dpt rabies	Mouse	D1R-cre (Guo et al., 2015; Wall et al., 2013), D2R-cre (Guo et al., 2015; Wall et al., 2013), ChAT-cre (Guo et al., 2015), PV-cre (Klug et al., 2018), Sepw1-NP67-cre (Smith et al., 2016), Plxnd1-OG1-cre (Smith et al., 2016)
	✓	R	Retrobeads	Mouse	(Pan et al., 2010)
	✓	R	FG, CTb	Mouse	(Hintiryan et al., 2016)
	✓	A	AAV	Mouse	(Gao et al., 2022; Wang et al., 2021), (Hintiryan et al., 2016)
	✓	A	PHA-L	Mouse	(Hoover and Vertes, 2011) <sup>b</sup> (Hintiryan et al., 2016)
GPe	✓	R	Cre-dpt rabies	Mouse	PV-cre (Lilascharoen et al., 2021)
	✓	A	AAV	Mouse	(Wang et al., 2021)
	✗	R	Cre-expressing lentivirus	Mouse	R26 <sup>LSL-tdTomato</sup> , (Cui et al., 2021)
STN	✗	A/R	(Hoover and Vertes, 2011; Wang et al., 2021; Cavdar et al., 2018; Parolari et al., 2021)		
SNr	✓	A	AAV	Mouse	(Gao et al., 2022; Wang et al., 2021)
	✓	A	PHA-L	Mouse	(Hoover and Vertes, 2011)
SNc	✓	R	Cre-dpt rabies	Mouse	DAT-cre (Watabe-Uchida et al., 2012)
	✓	A	PHA-L	Mouse	(Hoover and Vertes, 2011)
	✓	A	AAV	Mouse	(Gao et al., 2022)
SC	✓	R	Cre-dpt rabies	Mouse	vGlut2-cre (Doykos et al., 2020)
	✓	R	Ctb	Mouse	(Benavidez et al., 2021)
	✓	A	AAV	Mouse	(Wang et al., 2021) <sup>b</sup> (Benavidez et al., 2021)
	✓	A	PHA-L	Mouse	(Benavidez et al., 2021)
	✗	A	AAV	Mouse	(Gao et al., 2022)
MLR	✓	R	Cre-dpt rabies	Rat	ChAT-cre (Huerta-Ocampo et al., 2021)
	✓	R	rAAV2	Mouse	CaMKII-cre (Liu et al., 2022a)
	✓	A	PHA-L	Mouse	(Hoover and Vertes, 2011)
	✗	R	WGA-HRP	Rat	(Semba and Fibiger, 1992)
	✗	R	Cre-dpt rabies	Mouse	vGlut2-cre (Roseberry et al., 2016), vGat-cre (Roseberry et al., 2016)
GRN	✗	R	Cre-dpt rabies	Mouse	CHX10-cre (Cregg et al., 2020)
	✗	A	PHA-L	Mouse	(Hoover and Vertes, 2011)
LGRN	✗	A/R	(Sirieix et al., 2012) <sup>b</sup> (Hoover and Vertes, 2011; Van Bockstaele et al., 1989)		
Cg	A/R	Tracer	Rodent	Transgenic line	
M1	✓	R	Cre-dpt rabies	Mouse	Thy1-cre (Luo et al., 2019), vGat-cre (Luo et al., 2019), Rbp4-cre (Geng et al., 2022)
	✓	A	AAV	Mouse	(Shi et al., 2022)
	✓	A	PHA-L	Rat	(Sesack et al., 1989)
DS	✓	R	Cre-dpt rabies	Mouse	D1R-cre (Guo et al., 2015; Wall et al., 2013; Lu et al., 2021), D2R-cre (Guo et al., 2015; Wall et al., 2013; Lu et al., 2021), ChAT-cre (Guo et al., 2015; Klug et al., 2018), PV-cre (Klug et al., 2018), Sepw1-NP67-cre (Smith et al., 2016), Plxnd1-OG1-cre (Smith et al., 2016)
	✓	R	Retrobeads	Mouse	(Pan et al., 2010)
	✓	R	FG, CTb	Mouse	(Hintiryan et al., 2016)
	✓	A	AAV	Mouse	(Hintiryan et al., 2016; Gao et al., 2022; Shi et al., 2022)
	✓	A	PHA-L	Rat	(Hintiryan et al., 2016; Sesack et al., 1989)
GPe	✗	A/R	(Lilascharoen et al., 2021) <sup>b</sup> (Cui et al., 2021) <sup>c</sup> (Shi et al., 2022)		
STN	✓	R	BDA, FG	Rat	(Cavdar et al., 2018)
	✓	R	HRP	Rat	(Canteras et al., 1990)

(continued on next page)

Table 2 (continued)

OFC	A/R	Tracer	Rodent	Transgenic line & References
	✓	R Cre-dpt rabies, rAAV2	Mouse	(Li et al., 2020)
	✓	A WGA-HRP	Rat	(Canteras et al., 1990)
	✓	A AAV	Mouse	(Shi et al., 2022; Li et al., 2020)
	✗	R Cre-dpt rabies	Mouse	Gabbr3-cre (Parolari et al., 2021)
SNr	✓	A AAV	Mouse	CaMKII-cre (Liu et al., 2022a)
SNc	✗	R Cre-dpt rabies	Mouse	DAT-cre (Watabe-Uchida et al., 2012)
SC	✓	R Cre-dpt rabies	Mouse	vGlut2-cre (Doykos et al., 2020) (Campagner et al., 2023), vGat-cre (Campagner et al., 2023)
	✓	R Ctb	Mouse	(Benavidez et al., 2021)
	✓	A PHA-L	Mouse	(Benavidez et al., 2021)
	✓	A AAV	Mouse	(Gao et al., 2022) <sup>b</sup> (Benavidez et al., 2021; Shi et al., 2022), CaMKII-cre (Liu et al., 2022a)
MLR	✓	R Cre-dpt rabies	Rat	ChAT-cre (Huerta-Ocampo et al., 2021)
	✓	R rAAV2, CTb	Mouse	CaMKII-cre (Liu et al., 2022a)
	✓	A AAV	Mouse	CaMKII-cre (Liu et al., 2022a)
	✗	R Cre-dpt rabies	Mouse	vGlut2-cre (Roseberry et al., 2016), vGat-cre (Roseberry et al., 2016)
	✗	R WGA-HRP	Rat	(Semba and Fibiger, 1992)
GRN	✗	R Cre-dpt rabies	Mouse	CHX10-cre (Cregg et al., 2020)
	✓	A AAV	Mouse	CaMKII-cre (Liu et al., 2022a)
LGRN	✗	R FG	Rat	(Normandin and Murphy, 2008)
	✗	R CTb	Rat	(Sirieix et al., 2012)
	✗	A AAV	Mouse	CaMKII-cre (Liu et al., 2022a)
mPFC	A/R	Tracer	Rodent	Transgenic line
M1	✗	R Cre-dpt rabies	Mouse	Thy1-cre (Luo et al., 2019), CRF-cre (Zhao et al., 2020)
	✗	A PHA-L	Rat	(Sesack et al., 1989)
DS	✓	R Cre-dpt rabies	Mouse	D1R-cre (Guo et al., 2015; Wall et al., 2013; Lu et al., 2021), D2R-cre (Guo et al., 2015; Wall et al., 2013; Lu et al., 2021), ChAT-cre (Guo et al., 2015) (Klug et al., 2018), PV-cre (Klug et al., 2018), Sepw1-NP67-cre (Smith et al., 2016), Plxd1-OG1-cre (Smith et al., 2016)
	✓	R Retrobeads	Mouse	(Pan et al., 2010)
	✓	R FG, CTb	Mouse	(Hintiryan et al., 2016)
	✓	A PHA-L	Rat	(Sesack et al., 1989; Takagishi and Chiba, 1991; Vertes, 2004)
	✓	A AAV	Mouse	(Gao et al., 2022) <sup>b</sup> (Hintiryan et al., 2016)
GPe	✗	A/R (Liljascharoen et al., 2021; Cui et al., 2021; Sesack et al., 1989)		
STN	✓	R HRP	Rat	(Canteras et al., 1990)
	✓	R BDA, FG	Rat	(Cavdar et al., 2018)
	✓	A WGA-HRP	Rat	(Canteras et al., 1990)
	✗	R Cre-dpt rabies	Mouse	Gabbr3-cre (Parolari et al., 2021)
	✗	A PHA-L	Rat	(Sesack et al., 1989; Vertes, 2004)
SNr	✓	A AAV	Mouse	CaMKII-cre (Liu et al., 2022a)
	✓	A PHA-L	Rat	(Sesack et al., 1989)
SNc	✗	R Cre-dpt rabies	Mouse	DAT-cre (Watabe-Uchida et al., 2012)
	✓	A PHA-L	Rat	(Sesack et al., 1989; Vertes, 2004)
SC	✓	R Cre-dpt rabies	Mouse	vGlut2-cre (Campagner et al., 2023), vGat-cre (Campagner et al., 2023)
	✓	A AAV	Mouse	(Gao et al., 2022) <sup>b</sup> (Benavidez et al., 2021)
	✓	A PHA-L	Mouse	(Benavidez et al., 2021)
	✗	R Cre-dpt rabies	Mouse	vGlut2-cre (Doykos et al., 2020)

(continued on next page)



Table 2 (continued)

OFC	A/R	Tracer	Rodent	Transgenic line & References
MLR	✓	R	WGA-HRP	Rat (Semba and Fibiger, 1992)
	✓	R	rAAV2, CTb	Mouse CaMKII-cre (Liu et al., 2022a)
	✓	A	AAV	Mouse CaMKII-cre (Liu et al., 2022a)
	✓	A	PHA-L	Rat (Sesack et al., 1989; Vertes, 2004)
	✗	R	Cre-dpt rabies	Rat ChAT-cre (Huerta-Ocampo et al., 2021), vGlut2-cre (Roseberry et al., 2016), vGat-cre (Roseberry et al., 2016)
GRN	✗	R	Cre-dpt rabies	Mouse CHX10-cre (Cregg et al., 2020)
	✓	R	CTb	Rat (Hermann et al., 1997)
LGRN	✗	R	CTb	Rat (Sirieix et al., 2012)
	✓	R	WGA-HRP, FG	Rat (Van Bockstaele et al., 1989)
IC M1	A/R	Tracer	Rodent	Transgenic line
	✓	R	Cre-dpt rabies	Mouse Thy1-cre (Luo et al., 2019), vGat-cre (Luo et al., 2019), Rbp4-cre (Geng et al., 2022), CRF-cre (Zhao et al., 2020)
	✓	A	AAV	Mouse CaMKII-cre (Gehrlach et al., 2020, 2019)
DS	✓	R	Cre-dpt rabies	Mouse D1R-cre (Wall et al., 2013; Lu et al., 2021), D2R-cre (Lu et al., 2021) (Wall et al., 2013), ChAT-cre (Klug et al., 2018), PV-cre (Klug et al., 2018)
	✓	R	Retrobeads	Mouse (Pan et al., 2010)
	✓	A	AAV	Mouse CaMKII-cre (Gehrlach et al., 2020, 2019)
	✗	R	Cre-dpt rabies	Mouse D1R-cre (Guo et al., 2015), D2R-cre (Guo et al., 2015), ChAT-cre (Guo et al., 2015), Sepw1-NP67-cre (Smith et al., 2016), Plxnd1-OG1-cre (Smith et al., 2016)
GPe	✓	R	Cre-expressing lentivirus	Mouse R26 <sup>LSL-tdTomato</sup> (Cui et al., 2021)
	✓	A	AAV	Mouse (Gao et al., 2022), CaMKII-cre (Gehrlach et al., 2020, 2019)
	✗	R	Cre-dpt rabies	Mouse PV-cre (Lilascharoen et al., 2021)
STN	✓	R	HRP	Rat (Canteras et al., 1990)
	✓	R	BDA, FG	Rat (Cavdar et al., 2018)
	✓	A	WGA-HRP	Rat (Canteras et al., 1990)
	✗	R	Cre-dpt rabies	Mouse Gabrr3-cre (Parolari et al., 2021)
	✗	A	AAV	Mouse CaMKII-cre (Gehrlach et al., 2020)
SNr	✓	A	AAV	Mouse (Gao et al., 2022), CaMKII-cre (Gehrlach et al., 2020)
	✗	R	Cre-dpt rabies	Mouse Gad2-cre (Liu et al., 2020), PV-cre (Liu et al., 2020)
SNc	✓	A	AAV	Mouse (Gao et al., 2022)
	✗	R	Cre-dpt rabies	Mouse DAT-cre (Watabe-Uchida et al., 2012)
SC	✓	R	Cre-dpt rabies	Mouse vGlut2-cre (Doykos et al., 2020), Gad2-cre (Doykos et al., 2020)
	✗	A	PHA-L, AAV	Mouse (Benavidez et al., 2021)
	✗	A	AAV	Mouse CaMKII-cre (Gehrlach et al., 2020)
MLR	✓	R	Cre-dpt rabies	Rat ChAT-cre (Huerta-Ocampo et al., 2021)
	✓	R	rAAV2	Mouse CaMKII-cre (Liu et al., 2022a)
	✓	A	AAV	Mouse CaMKII-cre (Gehrlach et al., 2020, 2019)
	✗	R	WGA-HRP	Rat (Semba and Fibiger, 1992)
GRN	✗	R	Cre-dpt rabies	Mouse CHX10-cre (Cregg et al., 2020)
	✓	R	CTb	Rat (Hermann et al., 1997)
LGRN	✓	R	CTb	Rat (Sirieix et al., 2012)
	✗	R	FG	Rat (Normandin and Murphy, 2008)
	✗	R	WGA-HRP, FG	Rat (Van Bockstaele et al., 1989)
BLA M1	A/R	Tracer	Rodent	Transgenic line
	✓	R	Cre-dpt rabies	Mouse Thy1-cre (Luo et al., 2019), vGat-cre (Luo et al., 2019), Rbp4-cre (Geng et al., 2022)
	✓	R	CTb, FG, rAAV2	Mouse (Hintiryan et al., 2021)
	✓	A	PHA-L, AAV	Mouse (Hintiryan et al., 2021)

(continued on next page)

Table 2 (continued)

OFC	A/R	Tracer	Rodent	Transgenic line & References	
DS	✓	R	Cre-dpt rabies	Mouse	D1R-cre (Guo et al., 2015; Wall et al., 2013; Lu et al., 2021), D2R-cre (Guo et al., 2015; Wall et al., 2013; Lu et al., 2021), ChAT-cre (Guo et al., 2015)
	✓	R	Retrobeads	Mouse	(Pan et al., 2010)
	✓	R	CTb, FG, rAAV2	Mouse	(Hintiryan et al., 2021)
	✓	A	PHA-L, AAV	Mouse	(Hintiryan et al., 2021)
	✗	R	Cre-dpt rabies	Mouse	Sepw1-NP67-cre (Smith et al., 2016), Plxnd1-OG1-cre (Smith et al., 2016)
GPe	✗	A/R	(Lilascharoen et al., 2021; Cui et al., 2021; Hintiryan et al., 2021)		
STN	✓	R	BDA, FG	Rat	(Cavdar et al., 2018)
	✗	R	Cre-dpt rabies	Mouse	Gabbr3-cre (Parolari et al., 2021)
	✗	R	HRP	Rat	(Canteras et al., 1990)
	✗	R	CTb, FG, rAAV2	Mouse	(Hintiryan et al., 2021)
	✗	A	PHA-L, AAV	Mouse	(Hintiryan et al., 2021)
SNr	✓	A	PHA-L, AAV	Mouse	(Hintiryan et al., 2021)
	✗	R	Cre-dpt rabies	Mouse	Gad2-cre (Liu et al., 2020), PV-cre (Liu et al., 2020)
SNc	✓	A	PHA-L, AAV	Mouse	(Hintiryan et al., 2021)
	✗	R	Cre-dpt rabies	Mouse	DAT-cre (Watabe-Uchida et al., 2012)
SC	✗	A/R	(Doykos et al., 2020) <sup>b</sup> (Hintiryan et al., 2021)		
MLR	✗	A/R	(Roseberry et al., 2016; Huerta-Ocampo et al., 2021; Liu et al., 2022a; Semba and Fibiger, 1992), (Hintiryan et al., 2021)		
GRN	✗	R	CTb	Rat	(Hermann et al., 1997)
	✓	R	Cre-dpt rabies	Mouse	CHX10-cre (Cregg et al., 2020)
LGRN	✗	R	FG	Rat	(Normandin and Murphy, 2008) <sup>b</sup> (Van Bockstaele et al., 1989)
	✗	R	CTb	Rat	(Sirieix et al., 2012)
	✗	R	WGA-HRP	Rat	(Van Bockstaele et al., 1989)
CeA	A/R	Tracer	Rodent	Transgenic line	
MI	✗	R	Cre-dpt rabies	Mouse	Thy1-cre (Luo et al., 2019), vGat-cre (Luo et al., 2019), Rbp4-cre (Geng et al., 2022)
	✗	A	AAV	Mouse	Penk-cre (Viden et al., 2022)
DS	✓	R	Cre-dpt rabies	Mouse	D1R-cre (Wall et al., 2013; Lu et al., 2021), D2R-cre (Wall et al., 2013; Lu et al., 2021), Sepw1-NP67-cre (Smith et al., 2016), Plxnd1-OG1-cre (Smith et al., 2016)
	✓	R	Retrobeads	Mouse	(Pan et al., 2010)
	✗	R	Cre-dpt rabies	Mouse	D1R-cre (Guo et al., 2015), D2R-cre (Guo et al., 2015), ChAT-cre (Guo et al., 2015) <sup>c</sup> (Klug et al., 2018), PV-cre (Klug et al., 2018)
	✗	A	AAV	Mouse	Penk-cre (Viden et al., 2022)
GPe	✓	R	Cre-dpt rabies, retrobeads	Mouse	CRFR1-cre (Hunt et al., 2018b; Chang et al., 2022), NPAS1-cre (Hunt et al., 2018b), PV-cre (Lilascharoen et al., 2021)
	✓	R	Cre-expressing lentivirus	Mouse	R26 <sup>L<sup>SL</sup>-tdTomato</sup> , (Cui et al., 2021)
	✓	R	CTb, rAAV2	Mouse	(Giovanniello et al., 2020), SST-cre: Ai14 (Giovanniello et al., 2020), Rosa26-stop <sup>flax</sup> -H2B-GFP (Giovanniello et al., 2020)
	✓	A	AAV	Mouse	Penk-cre (Viden et al., 2022), SST-cre (Giovanniello et al., 2020)
STN	✓	R	Cre-dpt rabies	Mouse	Gabbr3-cre (Parolari et al., 2021)
	✓	R	BDA, FG	Rat	(Cavdar et al., 2018)
	✓	R	HRP	Rat	(Canteras et al., 1990)
	✓	A	AAV	Mouse	Penk-cre (Viden et al., 2022)
	✗	A	WGA-HRP	Rat	(Canteras et al., 1990)
SNr	✓	R	FG	Rat	(Zahm et al., 2011)
	✓	R	Cre-dpt rabies	Mouse	Gad2-cre (Liu et al., 2020), PV-cre (Liu et al., 2020; Chang et al., 2022)
	✓	A	AAV	Mouse	Penk-cre (Viden et al., 2022)
SNc	✓	R	FG	Rat	(Zahm et al., 2011)

(continued on next page)

Table 2 (continued)

OFC	A/R	Tracer	Rodent	Transgenic line & References
	✓	R Cre-dpt rabies	Mouse	DAT-cre (Watabe-Uchida et al., 2012), TH-FlpO (Chang et al., 2022), CRHR1-cre (Chang et al., 2022), vGat-FlpO (Chang et al., 2022)
	✓	A AAV	Mouse	Penk-cre (Viden et al., 2022), CRH-cre (Chang et al., 2022)
	✓	A PHA-L	Rat	(Wallace et al., 1992; Gonzales and Chesselet, 1990)
SC	✗	A/R (Viden et al., 2022; Benavidez et al., 2021; Doykos et al., 2020)		
MLR	✓	R Tritiated leucine	Rat	(Garcia-Rill et al., 1983)
	✓	R WGA-HRP	Rat	(Semba and Fibiger, 1992; Steininger et al., 1992)
	✓	R Cre-dpt rabies	Rat	ChAT-cre (Huerta-Ocampo et al., 2021)
	✓	R Cre-dpt rabies	Mouse	vGlut2-cre (Roseberry et al., 2016), vGat-cre (Roseberry et al., 2016)
	✓	R Cav	Mouse	vGat-cre (Roseberry et al., 2019)
	✓	A AAV	Mouse	Penk-cre (Viden et al., 2022), vGat-cre (Roseberry et al., 2019)
GRN	✓	R CTb	Rat	(Hermann et al., 1997)
	✓	R Cre-dpt rabies	Mouse	CHX10-cre (Cregg et al., 2020)
	✓	A AAV	Mouse	Penk-cre (Viden et al., 2022)
	✓	A PHA-L	Rat	(Wallace et al., 1992)
LGRN	✓	R FG	Rat	(Normandin and Murphy, 2008)
	✓	R CTb	Rat	(Sirieix et al., 2012)
	✗	R WGA-HRP, FG	Rat	(Van Bockstaele et al., 1989)
BNST	A/R	Tracer	Rodent	Transgenic line
M1	✗	R Cre-dpt rabies	Mouse	Thy1-cre (Luo et al., 2019), vGat-cre (Luo et al., 2019), Rbp4-cre (Geng et al., 2022)
	✗	A PHA-L	Rat	(Dong et al., 2001; Dong and Swanson, 2004a, 2006a, 2006a, 2006b, 2004b, 2003)
DS	✓	R Cre-dpt rabies	Mouse	D1R-cre (Lu et al., 2021), D2R-cre (Lu et al., 2021), ChAT -cre (Klug et al., 2018), PV-cre (Klug et al., 2018), Sepw1-NP67-cre (Smith et al., 2016), Plxnd1-OG1-cre (Smith et al., 2016)
	✓	A AAV	Mouse	Sepw1-NP67-cre (Smith et al., 2016), Plxnd1-OG1-cre (Smith et al., 2016)
	✓	A PHA-L	Rat	(Dong and Swanson, 2004a)
	✗	R Cre-dpt rabies	Mouse	D1R-cre (Guo et al., 2015; Wall et al., 2013), DR-cre (Guo et al., 2015; Wall et al., 2013), ChAT-cre (Guo et al., 2015)
	✗	R Retrobeads	Mouse	(Pan et al., 2010)
GPe	✓	R Cre-dpt rabies, retrobeads	Mouse	CRFR1-cre (Hunt et al., 2018b; Chang et al., 2022), NPAS1-cre (Hunt et al., 2018b), PV-cre (Lilascharoen et al., 2021)
	✓	R Cre-expressing lentivirus	Mouse	R26 <sup>LSL-tdTomato</sup> , (Cui et al., 2021) <sup>1</sup>
	✓	A PHA-L	Rat	(Dong et al., 2001)
STN	✓	R Cre-dpt rabies	Mouse	Gabbr3-cre (Parolari et al., 2021)
	✓	R BDA, FG	Rat	(Cavdar et al., 2018)
	✓	A PHA-L	Rat	(Dong et al., 2001)
	✗	R HRP	Rat	(Canteras et al., 1990)
	✗	A PHA-L	Rat	(Dong and Swanson, 2004a, 2006a, 2006a, 2006b, 2004b, 2003)
SNr	✓	R Cre-dpt rabies	Mouse	PV-cre (Chang et al., 2022)
	✓	A AAV	Rat	CRF-cre-GFP (Dabrowska et al., 2016)
	✗	R FG	Rat	(Zahm et al., 2011)
	✗	A PHA-L	Rat	(Dong et al., 2001; Dong and Swanson, 2004a, 2006a, 2006a, 2006b, 2004b, 2003)
SNc	✓	R Cre-dpt rabies	Mouse	DAT-cre (Watabe-Uchida et al., 2012), TH-FlpO (Chang et al., 2022), CRHR1-cre (Chang et al., 2022), vGat-FlpO (Chang et al., 2022)
	✓	R FG	Rat	(Zahm et al., 2011)
	✓	A AAV	Rat	CRF-cre-GFP (Dabrowska et al., 2016)
	✓	A AAV	Mouse	Plxnd1-OG1-cre (Smith et al., 2016), CRF-cre (Chang et al., 2022)
	✓	A PHA-L	Rat	(Dong and Swanson, 2004a)
SC	✗	A/R (Benavidez et al., 2021; Doykos et al., 2020; Dong et al., 2001; Dong and Swanson, 2004a, 2006a, 2006a, 2006b, 2004b, 2003)		

(continued on next page)

Table 2 (continued)

OFC	A/R	Tracer	Rodent	Transgenic line & References
MLR	✓	R	SITS, True blue	Rat (Swanson et al., 1984)
	✓	R	Cre-dpt rabies	Mouse vGlut2-cre (Dautan et al., 2021; Roseberry et al., 2016), vGat-cre (Roseberry et al., 2016)
	✓	R	rAAV2	Mouse CaMKII-cre (Liu et al., 2022a)
	✓	R	WGA-HRP	Rat (Semba and Fibiger, 1992) <sup>1</sup> (Steininger et al., 1992)
	✓	A	PHA-L	Rat (Dong and Swanson, 2003)
	✗	R	Cre-dpt rabies	Rat ChAT-cre (Huerta-Ocampo et al., 2021)
	✗	A	PHA-L	Rat (Dong et al., 2001; Dong and Swanson, 2006a, 2006a, 2006b, 2004b)
GRN	✓	R	CTb	Rat (Hermann et al., 1997)
	✓	A	PHA-L	Rat (Dong and Swanson, 2003)
LGRN	✓	R	FG	Rat (Normandin and Murphy, 2008)
	✓	R	CTb	Rat (Sirieix et al., 2012)
	✓	A	PHA-L	Rat (Dong and Swanson, 2003)
	✗	R/A	(Van Bockstaele et al., 1989; Dong et al., 2001; Dong and Swanson, 2006a, 2006a, 2006b, 2004b)	
NAc	A/R	Tracer	Rodent	Transgenic line
	✗	R	Cre-dpt rabies	Mouse Thy1-cre (Luo et al., 2019), vGat-cre (Luo et al., 2019), Rbp4-cre (Geng et al., 2022)
DS	✓	R	Cre-dpt rabies	Mouse D1R-cre (Lu et al., 2021), D2R-cre (Lu et al., 2021)
	✓	A	BDA	Rat (Usuda et al., 1998)
	✗	R	(Smith et al., 2016; Guo et al., 2015; Wall et al., 2013; Klug et al., 2018; Pan et al., 2010)	
GPe	✓	A	H-proline	Rat (Mogenson et al., 2023)
	✓	A	PHA-L	Rat (Zahm and Heimer, 1993)
	✓	A	BDA	Rat (Usuda et al., 1998)
	✗	R	Cre-expressing lentivirus	Mouse R26 <sup>LSL-tdTomato</sup> , (Cui et al., 2021) <sup>1</sup>
	✗	R	Cre-dpt rabies	Mouse PV-cre (Lilascharoen et al., 2021) <sup>1</sup> (Chang et al., 2022)
	✗	R	True blue	Rat (Mogenson et al., 2023)
STN	✗	A	Tritiated proline-Leucine	Rat (Nauta et al., 1978)
	✓	R	FG	Rat (Cavdar et al., 2018) <sup>1</sup>
	✓	A	BDA	Rat (Cavdar et al., 2018; Usuda et al., 1998)
	✗	R	Cre-dpt rabies	Mouse Gabrr3-cre (Parolari et al., 2021)
SNr	✗	R	HRP	Rat (Canteras et al., 1990)
	✓	R	FG	Rat (Zahm et al., 2011)
	✓	R	Cre-dpt rabies	Mouse Gad2-cre (Liu et al., 2020)
	✓	R	WGA-HRP	Rat (Deniau et al., 1994)
	✓	A	WGA-HRP	Rat (Deniau et al., 1994)
SNc	✓	A	BDA	Rat (Usuda et al., 1998)
	✓	A	Tritiated proline-Leucine	Rat (Nauta et al., 1978)
	✓	R	FG	Rat (Zahm et al., 2011)
	✓	R	Cre-dpt rabies	Mouse DAT-cre (Watabe-Uchida et al., 2012), TH-FlpO (Chang et al., 2022), CRHR1-cre (Chang et al., 2022), vGat-FlpO (Chang et al., 2022)
SC	✓	A	PHAL	Rat (Heimer et al., 1991)
	✓	A	BDA	Rat (Usuda et al., 1998)
	✗	R	(Benavidez et al., 2021; Doykos et al., 2020)	
MLR	✓	R	Cre-dpt rabies	Mouse vGlut2-cre (Caggiano et al., 2018)
	✓	R	Cre-dpt rabies	Rat ChAT-cre (Huerta-Ocampo et al., 2021)
	✗	R	WGA-HRP	Rat (Semba and Fibiger, 1992; Steininger et al., 1992)
GRN	✗	R	CTb	Rat (Hermann et al., 1997)

(continued on next page)

Table 2 (continued)

OFC	A/R	Tracer	Rodent	Transgenic line & References
	X	R Cre-dpt rabies	Mouse	CHX10-cre (Cregg et al., 2020)
LGRN	X	R FG	Rat	(Normandin and Murphy, 2008) <sup>b</sup> (Van Bockstaele et al., 1989)
	X	R CTb	Rat	(Sirieix et al., 2012)
	X	R WGA-HRP	Rat	(Van Bockstaele et al., 1989)
VP	A/R	Tracer	Rodent	Transgenic line
M1	X	A/R (Rizzi and Tan, 2019; Hormigo et al., 2021; Villalobos and Basso, 2022; Groenewegen et al., 1993)		
DS	✓	R Cre-dpt rabies	Mouse	D1R-cre (Lu et al., 2021), D2R-cre (Lu et al., 2021)
	✓	A AAV	Mouse	(Feng et al., 2021)
	X	R (Guo et al., 2015; Wall et al., 2013; Klug et al., 2018; Pan et al., 2010)		
	X	A AAV	Mouse	vGlut2-cre (Faget et al., 2018), vGat-cre (Faget et al., 2018), ChAT-cre (Faget et al., 2018)
GPe	✓	A AAV	Mouse	(Feng et al., 2021)
	X	R Cre-dpt rabies	Mouse	PV-cre (Lilascharoen et al., 2021)
	X	R Cre-expressing lentivirus	Mouse	R26 <sup>LSL-tdTomato</sup> , (Cui et al., 2021) <sup>c</sup>
STN	✓	R BDA, FG	Rat	(Cavdar et al., 2018)
	✓	R HRP	Rat	(Canteras et al., 1990)
	✓	A WGA-HRP	Rat	(Canteras et al., 1990)
	✓	A AAV	Mouse	vGat-cre (Faget et al., 2018)
	✓	A PHA-L	Rat	(Groenewegen et al., 1993) <sup>b</sup> (Bevan et al., 1997)
	✓	A BDA	Rat	(Bevan et al., 1997)
	X	R Cre-dpt rabies	Mouse	Gabbr3-cre (Parolari et al., 2021)
	X	A AAV	Mouse	vGlut2-cre (Faget et al., 2018), ChAT-cre (Faget et al., 2018)
SNr	✓	R CTb	Rat	(Groenewegen et al., 1993)
	✓	A PHA-L	Rat	(Groenewegen et al., 1993) <sup>b</sup> (Bevan et al., 1997)
	X	R Cre-dpt rabies	Mouse	Gad2-cre (Liu et al., 2020)
	X	R FG	Rat	(Conio et al., 2020)
	X	A AAV	Mouse	vGlut2-cre (Faget et al., 2018), vGat-cre (Faget et al., 2018), ChAT-cre (Faget et al., 2018)
SNc	✓	R Cre-dpt rabies	Mouse	DAT-cre (Watabe-Uchida et al., 2012)
	✓	R FG	Rat	(Zahm et al., 2011)
	✓	R CTb	Rat	(Groenewegen et al., 1993)
	✓	A AAV	Mouse	vGlut2-cre (Faget et al., 2018), vGat-cre (Faget et al., 2018)
	✓	A PHA-L	Rat	(Groenewegen et al., 1993; Bevan et al., 1996)
	X	A AAV	Mouse	ChAT-cre (Faget et al., 2018)
SC	✓	A AAV	Mouse	(Feng et al., 2021)
	X	R Cre-dpt rabies	Mouse	vGlut2-cre (Doykos et al., 2020)
	X	R CTb	Mouse	(Benavidez et al., 2021)
	X	A AAV, PHA-L	Mouse	(Benavidez et al., 2021)
MLR	✓	R Cre-dpt rabies	Rat	ChAT-cre (Huerta-Ocampo et al., 2021)
	✓	R WGA-HRP	Rat	(Semba and Fibiger, 1992)
	✓	A AAV	Mouse	(Feng et al., 2021), vGlut2-cre (Faget et al., 2018), vGat-cre (Faget et al., 2018)
	X	R WGA-HRP	Rat	(Steininger et al., 1992)
	X	R rAAV2	Mouse	CaMKII-cre (Liu et al., 2022a)
GRN	X	R CTb	Rat	(Hermann et al., 1997)
	X	R Cre-dpt rabies	Mouse	CHX10-cre (Cregg et al., 2020)

(continued on next page)

Table 2 (continued)

OFC	A/R	Tracer	Rodent	Transgenic line & References
LGRN	X	R FG	Rat	(Normandin and Murphy, 2008)
	X	R CTb	Rat	(Sirieix et al., 2012)
	X	R WGA-HRP, FG	Rat	(Van Bockstaele et al., 1989)
LS	A/R	Tracer	Rodent	Transgenic line
M1	X	A/R (Deng et al., 2019; Zhao et al., 2020; Luo et al., 2019; Geng et al., 2022)		
DS	✓	R Cre-dpt rabies	Mouse	ChAT-cre (Klug et al., 2018), PV-cre (Klug et al., 2018)
	X	A/R (Smith et al., 2016; Guo et al., 2015; Deng et al., 2019; Wall et al., 2013; Pan et al., 2010)		
GPe	X	A/R (Lilascharoen et al., 2021; Cui et al., 2021; Deng et al., 2019)		
STN	X	A/R (Cavdar et al., 2018) <sup>b</sup> (Parolari et al., 2021) (Deng et al., 2019; Canteras et al., 1990)		
SNr	X	A/R (Zahm et al., 2011; Liu et al., 2020; Deng et al., 2019)		
SNC	X	A/R (Zahm et al., 2011; Watabe-Uchida et al., 2012; Deng et al., 2019)		
SC	✓	R CTb	Mouse	(Benavidez et al., 2021)
	✓	A PHA-L, AAV	Mouse	(Benavidez et al., 2021)
	✓	A HSV-EGFP	Mouse	(Deng et al., 2019)
	X	R Cre-dpt rabies	Mouse	vGlut2-cre (Doykos et al., 2020), Gad2-cre (Doykos et al., 2020)
MLR	X	R (Deng et al., 2019; Huerta-Ocampo et al., 2021; Liu et al., 2022a; Semba and Fibiger, 1992; Steininger et al., 1992)		
GRN	X	R CTb	Rat	(Hermann et al., 1997)
	X	R Cre-dpt rabies	Mouse	CHX10-cre (Cregg et al., 2020)
LGRN	X	R FG	Rat	(Normandin and Murphy, 2008)
	X	R WGA-HRP, FG	Rat	(Van Bockstaele et al., 1989)
	X	R CTb	Rat	(Sirieix et al., 2012)
LH	A/R	Tracer	Rodent	Transgenic line
M1	X	A/R (Zhao et al., 2020; Luo et al., 2019; Geng et al., 2022; Berk and Finkelstein, 1982; Hahn and Swanson, 2010)		
DS	✓	R Cre-dpt rabies	Mouse	D1R-cre (Lu et al., 2021), D2R-cre (Lu et al., 2021)
	X	R/A (Guo et al., 2015; Wall et al., 2013; Pan et al., 2010; Berk and Finkelstein, 1982; Hahn and Swanson, 2010)		
GPe	✓	R Cre-dpt rabies	Mouse	PV-cre (Lilascharoen et al., 2021; Chang et al., 2022)
	X	R Cre-expressing lentivirus	Mouse	R26 <sup>LSL-tdTomato</sup> , (Cui et al., 2021) <sup>1</sup>
	X	A PHA-L	Rat	(Hahn and Swanson, 2010)
	X	A H-Leucine	Rat	(Berk and Finkelstein, 1982)
STN	✓	R BDA, FG	Rat	(Cavdar et al., 2018)
	✓	R Cre-dpt rabies	Mouse	Gabbr3-cre (Parolari et al., 2021)
	X	R HRP	Rat	(Canteras et al., 1990)
	X	A H-Leucine	Rat	(Berk and Finkelstein, 1982)
	X	A PHA-L	Rat	(Hahn and Swanson, 2010)
SNr	✓	R Cre-dpt rabies	Mouse	Gad2-cre (Liu et al., 2020)
	✓	A WGA-HRP	Rat	(Celio et al., 2013) *
	✓	A AAV	Mouse	Mc3R-T2A-cre (Pei et al., 2019)
	X	R FG	Rat	(Zahm et al., 2011)
	X	A H-Leucine	Rat	(Berk and Finkelstein, 1982)
	X	A PHA-L	Rat	(Hahn and Swanson, 2010)
SNC	✓	R Cre-dpt rabies	Mouse	DAT-cre (Watabe-Uchida et al., 2012), TH-FlpO (Chang et al., 2022), CRHR1-cre (Chang et al., 2022), vGat-FlpO (Chang et al., 2022)
	✓	R FG	Rat	(Zahm et al., 2011)

(continued on next page)

Table 2 (continued)

OFC	A/R	Tracer	Rodent	Transgenic line & References
	✓	R FG	Mouse	NTS-cre-GFP (Brown et al., 2019)
	✓	A/R H-Leucine /HRP	Rat	(Wright et al., 1980)
	✗	A H-Leucine	Rat	(Berk and Finkelstein, 1982)
	✗	A PHA-L	Rat	(Hahn and Swanson, 2010)
SC	✓	A H-Leucine	Rat	(Berk and Finkelstein, 1982)
	✓	A PHA-L	Rat	(Hahn and Swanson, 2010)
	✗	R CTb	Mouse	(Benavidez et al., 2021)
MLR	✓	R rAAV2	Mouse	CaMKII-cre (Liu et al., 2022a)
	✓	R WGA-HRP	Rat	(Semba and Fibiger, 1992;Steininger et al., 1992)
	✓	R Cre-dpt rabies	Mouse	vGlut2-cre (Caggiano et al., 2018)
	✓	A WGA-HRP	Rat	(Celio et al., 2013)
	✓	A PHA-L	Rat	(Hahn and Swanson, 2010;Celio et al., 2013)
	✓	A BDA	Rat	(Papp and Palkovits, 2014)
GRN	✓	R CTb	Rat	(Hermann et al., 1997)
	✓	A PHA-L	Rat	(Hahn and Swanson, 2010)
	✓	A BDA	Rat	(Papp and Palkovits, 2014)
	✗	R Cre-dpt rabies	Mouse	CHX10-cre (Gregg et al., 2020)
LGRN	✓	R FG	Rat	(Normandin and Murphy, 2008;Van Bockstaele et al., 1989)
	✓	R WGA-HRP	Rat	(Van Bockstaele et al., 1989)
	✓	R HRP	Rat	(Andrezik et al., 1981)
	✓	R CTb	Rat	(Sirieix et al., 2012)
	✓	A PHA-L	Rat	(Hahn and Swanson, 2010)
	✓	A BDA	Rat	(Papp and Palkovits, 2014)
PVN	A/R	Tracer	Rodent	Transgenic line
MI	✓	A AAV	Mouse	AVP-cre (Freda et al., 2022)
	✗	R Cre-dpt rabies	Mouse	CRF-cre (Zhao et al., 2020), Thy1-cre (Luo et al., 2019), vGat-cre (Luo et al., 2019), Rbp4-cre (Geng et al., 2022),
DS	✓	R Cre-dpt rabies	Mouse	Sepw1-NP67-cre (Smith et al., 2016), Plxnd1-OG1-cre (Smith et al., 2016)
	✓	A AAV	Mouse	AVP-cre (Freda et al., 2022), Oxt-cre (Freda et al., 2022)
	✗	R (Guo et al., 2015; Wall et al., 2013; Klug et al., 2018; Pan et al., 2010; Lu et al., 2021)		
GPe	✓	R Cre-dpt rabies, retrobeads	Mouse	CRFR1-cre (Hunt et al., 2018b; Chang et al., 2022), NPAS1-cre (Hunt et al., 2018b)
	✓	A AAV	Mouse	AVP-cre (Freda et al., 2022), Oxt-cre (Freda et al., 2022; Son et al., 2022)
	✗	R Cre-expressing lentivirus	Mouse	R26 <sup>LSL-tdTomato</sup> , (Cui et al., 2021)
STN	✗	A/R (Cavdar et al., 2018) <sup>b</sup> (Freda et al., 2022; Parolari et al., 2021; Canteras et al., 1990)		
	✓	A AAV	Mouse	Oxt-cre (Son et al., 2022)
SNr	✓	A AAV	Mouse	AVP-cre (Freda et al., 2022), Oxt-cre (Freda et al., 2022)
	✗	R FG	Rat	(Zahm et al., 2011)
SNc	✓	R Cre-dpt rabies	Mouse	DAT-cre (Watabe-Uchida et al., 2012), TH-FlpO (Chang et al., 2022), CRHR1-cre (Chang et al., 2022), vGat-FlpO (Chang et al., 2022)
	✓	R HRP	Rat	(Wright et al., 1980)
	✓	R FG	Rat	(Zahm et al., 2011)
	✓	A AAV	Mouse	AVP-cre (Freda et al., 2022), Oxt-cre (Freda et al., 2022; Son et al., 2022)
SC	✓	A AAV	Mouse	AVP-cre (Freda et al., 2022), Oxt-cre (Freda et al., 2022; Son et al., 2022)
	✗	R CTb	Mouse	(Benavidez et al., 2021)
MLR	✓	R rAAV2	Mouse	CaMKII-cre (Liu et al., 2022a)
	✓	R WGA-HRP	Rat	(Semba and Fibiger, 1992) <sup>b</sup> (Steininger et al., 1992)
	✓	A AAV	Mouse	Oxt-cre (Freda et al., 2022; Son et al., 2022)

(continued on next page)

Table 2 (continued)

OFC	A/R	Tracer	Rodent	Transgenic line & References
	✓	A PHA-L	Rat	(Geerling et al., 2010)
GRN	✗	R Cre-dpt rabies	Mouse	CHX10-cre (Cregg et al., 2020)
	✓	R CTb	Rat	(Hermann et al., 1997)
	✓	A AAV	Mouse	Oxt-cre (Son et al., 2022)
LGRN	✓	R FG	Rat	(Normandin and Murphy, 2008) <sup>b</sup> (Van Bockstaele et al., 1989)
	✓	R CTb	Rat	(Sirieix et al., 2012)
	✓	R WGA-HRP	Rat	(Van Bockstaele et al., 1989)
	✓	R HRP	Rat	(Andrejik et al., 1981)
	✓	A PHA-L	Rat	(Bancila et al., 2002)
	✓	A AAV	Mouse	Oxt-cre (Son et al., 2022)
DRN	A/R	Tracer	Rodent	Transgenic line
MI	✓	R Rabies	Mouse	(Huang et al., 2019)
	✓	R Cre-dpt rabies	Mouse	Thy1-cre (Luo et al., 2019), vGat-cre (Luo et al., 2019), Rbp4-cre (Geng et al., 2022)
	✓	A AAV	Mouse	SERT-cre (Muzerelle et al., 2016)
	✗	R Cre-dpt rabies	Mouse	CRF-cre (Zhao et al., 2020)
	✗	A PHA-L	Rat	(Sim and Joseph, 1993)
DS	✓	R Rabies	Mouse	(Huang et al., 2019)
	✓	R Cre-dpt rabies	Mouse	D1R-cre (Guo et al., 2015; Wall et al., 2013), D2R-cre (Guo et al., 2015; Wall et al., 2013), ChAT-cre (Guo et al., 2015; Klug et al., 2018), PV-cre (Klug et al., 2018), Sepw1-NP67-cre (Smith et al., 2016), Plxnd1-OG1-cre (Smith et al., 2016)
	✓	R Retrobeads	Mouse	(Pan et al., 2010)
	✓	A AAV	Mouse	SERT-cre (Muzerelle et al., 2016)
	✓	A PHA-L	Rat	(Sim and Joseph, 1993)
	✗	R Cre-dpt rabies	Mouse	D1R-cre (Lu et al., 2021), D2R-cre (Lu et al., 2021)
GPe	✓	R Cre-expressing lentivirus	Mouse	R26 <sup>LSL-tdTomato</sup> , (Cui et al., 2021)
	✓	R Rabies	Mouse	(Huang et al., 2019)
	✓	A PHA-L	Rat	(Sim and Joseph, 1993)
	✗	A AAV	Mouse	SERT-cre (Muzerelle et al., 2016)
STN	✓	R Cre-dpt rabies	Mouse	Gabbr3-cre (Parolari et al., 2021)
	✓	R BDA, FG	Rat	(Cavdar et al., 2018)
	✓	R HRP	Rat	(Canteras et al., 1990)
	✓	A WGA-HRP	Rat	(Canteras et al., 1990)
	✓	A PHA-L	Rat	(Sim and Joseph, 1993)
	✗	A AAV	Mouse	SERT-cre (Muzerelle et al., 2016)
SNr	✓	R FG	Rat	(Zahm et al., 2011)
	✓	R HRP	Rat	(Fibiger and Miller, 1977)
	✓	A H-Leucine	Rat	(Fibiger and Miller, 1977)
	✓	A AAV	Mouse	SERT-cre (Muzerelle et al., 2016)
	✓	A PHA-L	Rat	(Sim and Joseph, 1993)
SNc	✓	R Cre-dpt rabies	Mouse	DAT-cre (Watabe-Uchida et al., 2012)
	✓	R FG	Rat	(Zahm et al., 2011)
	✓	R HRP	Rat	(Fibiger and Miller, 1977)
	✓	A H-Leucine	Rat	(Fibiger and Miller, 1977)
	✓	A AAV	Mouse	SERT-cre (Muzerelle et al., 2016)
	✓	A PHA-L	Rat	(Sim and Joseph, 1993)
SC	✓	R CTb	Mouse	(Benavidez et al., 2021)
	✓	A AAV	Mouse	(Benavidez et al., 2021), SERT-cre (Muzerelle et al., 2016)

(continued on next page)



Table 2 (continued)

OFC	A/R	Tracer	Rodent	Transgenic line & References
	✓	A PHA-L	Mouse	(Benavidez et al., 2021)
	✓	A PHA-L	Rat	(Sim and Joseph, 1993)
	✗	R Cre-dpt rabies	Mouse	vGlut2-cre (Doykos et al., 2020), Gad2-cre (Doykos et al., 2020)
MLR	✓	R Cre-dpt rabies	Rat	ChAT-cre (Huerta-Ocampo et al., 2021)
	✓	R rAAV2	Mouse	CaMKII-cre (Liu et al., 2022a)
	✓	R Cre-dpt rabies	Mouse	vGlut2-cre (Roseberry et al., 2016; Caggiano et al., 2018), vGat-cre (Roseberry et al., 2016)
	✓	R WGA-HRP	Rat	(Semba and Fibiger, 1992) <sup>b</sup> (Steininger et al., 1992)
	✓	A PHA-L	Rat	(Sim and Joseph, 1993)
GRN	✓	R CTb	Rat	(Hermann et al., 1997)
	✓	A PHA-L	Rat	(Sim and Joseph, 1993)
	✗	R Cre-dpt rabies	Mouse	CHX10-cre (Cregg et al., 2020)
LGRN	✓	R FG	Rat	(Normandin and Murphy, 2008) <sup>b</sup> (Van Bockstaele et al., 1989)
	✓	R WGA-HRP	Rat	(Van Bockstaele et al., 1989)
	✓	R CTb	Rat	(Sirieix et al., 2012)
	✓	A PHA-L	Rat	(Sim and Joseph, 1993)
	✗	R HRP	Rat	(Andrejik et al., 1981)
VTA	A/R	Tracer	Rodent	Transgenic line
MI	✓	R Cre-dpt rabies	Mouse	Thy1-cre (Luo et al., 2019), vGat-cre (Luo et al., 2019), Rbp4-cre (Geng et al., 2022)
	✓	R Fast-Blue	Rat	(Hosp et al., 2011, 2015; Leemburg et al., 2018)
	✓	A BDA	Mouse	(Aransay et al., 2015)
	✗	R Cre-dpt rabies	Mouse	CRF-cre (Zhao et al., 2020)
	✗	A AAV	Mouse	(He et al., 2021)
DS	✓	R Cre-dpt rabies	Mouse	D1R-cre (Lu et al., 2021), D2R-cre (Lu et al., 2021)
	✓	R Retrobeads	Mouse	(Pan et al., 2010)
	✓	A AAV	Mouse	(He et al., 2021; Beier et al., 2015), Gad67-cre (Chowdhury et al., 2019)
	✓	A BDA	Mouse	(Aransay et al., 2015)
	✗	R Cre-dpt rabies	Mouse	D1R-cre (Wall et al., 2013), D2R-cre (Wall et al., 2013), Sepw1-NP67-cre (Smith et al., 2016), Plxnd1-OG1-cre (Smith et al., 2016)
GPe	✓	A BDA	Mouse	(Aransay et al., 2015)
	✗	R Cre-expressing lentivirus	Mouse	R26 <sup>LSL-tdTomato</sup> (Cui et al., 2021) <sup>1</sup>
	✗	R Cre-dpt rabies	Mouse	PV-cre (Lilascharoen et al., 2021)
	✗	A AAV	Mouse	(He et al., 2021)
STN	✓	R BDA, FG	Rat	(Cavdar et al., 2018)
	✓	R Cre-dpt rabies	Mouse	Gabbr3-cre (Parolari et al., 2021)
	✓	A BDA	Mouse	(Aransay et al., 2015)
	✗	R HRP	Rat	(Canteras et al., 1990)
	✗	A AAV	Mouse	(He et al., 2021)
SNr	✓	R FG	Rat	(Zahm et al., 2011)
	✓	A AAV	Mouse	(He et al., 2021)
	✗	A BDA	Mouse	(Aransay et al., 2015)
SNc	✓	R FG	Rat	(Zahm et al., 2011)
	✓	A BDA	Mouse	(Aransay et al., 2015)
	✗	A AAV	Mouse	(He et al., 2021)
SC	✗	A/R (Aransay et al., 2015; He et al., 2021; Benavidez et al., 2021; Doykos et al., 2020)		
MLR	✓	R Cre-dpt rabies	Rat	ChAT-cre (Huerta-Ocampo et al., 2021)

(continued on next page)

Table 2 (continued)

OFC	A/R	Tracer	Rodent	Transgenic line & References
	✓	R WGA-HRP	Rat	(Semba and Fibiger, 1992; Steininger et al., 1992)
	✓	R rAAV2	Mouse	CaMKII-cre (Liu et al., 2022a)
	✓	R Cre-dpt rabies	Mouse	vGlut2-cre (Dautan et al., 2021; Roseberry et al., 2016), vGat-cre (Roseberry et al., 2016)
	✓	A AAV	Mouse	Gad67-cre (Chowdhury et al., 2019)
	✓	A BDA	Mouse	(Aransay et al., 2015)
GRN	✗	R CTb	Rat	(Hermann et al., 1997)
	✗	R Cre-dpt rabies	Mouse	CHX10-cre (Cregg et al., 2020)
LGRN	✗	R WGA-HRP, FG	Rat	(Van Bockstaele et al., 1989)
	✗	R CTb	Rat	(Sirieix et al., 2012)
	✗	R HRP	Rat	(Andrejik et al., 1981)
	✓	R FG	Rat	(Normandin and Murphy, 2008)
LC	A/R	Tracer	Rodent	Transgenic line
M1	✓	R Dextran, fluorescein, rhodamine conjugated	Rat	(Chandler et al., 2014)
	✓	A-R Cav-cre	Mouse	<i>En1<sup>Dre</sup>x Dbh<sup>Fipox</sup> RC::RFLTG</i> (Plummer et al., 2020)
	✗	R Cre-dpt rabies	Mouse	Thy1-cre (Luo et al., 2019), vGat-cre (Luo et al., 2019), Rbp4-cre (Geng et al., 2022), CRF-cre (Zhao et al., 2020)
DS	✗	A/R		(Smith et al., 2016; Guo et al., 2015; Wall et al., 2013; Pan et al., 2010; Lu et al., 2021; Plummer et al., 2020)
GPe	✗	A/R		(Lilascharoen et al., 2021; Cui et al., 2021), (Plummer et al., 2020)
STN	✓	R BDA, FG	Rat	(Cavdar et al., 2018)
	✓	R HRP	Rat	(Canteras et al., 1990)
	✗	R Cre-dpt rabies	Mouse	Gabbr3-cre (Parolari et al., 2021)
	✗	A WGA-HRP	Rat	(Canteras et al., 1990)
	✗	A Cav-cre (in M1 or mPFC)	Mouse	<i>En1<sup>Dre</sup>x Dbh<sup>Fipox</sup> RC::RFLTG</i> (Plummer et al., 2020)
SNr	✓	A Cav-cre (in M1 or mPFC)	Mouse	<i>En1<sup>Dre</sup>x Dbh<sup>Fipox</sup> RC::RFLTG</i> (Plummer et al., 2020)
	✗	R FG	Rat	(Zahm et al., 2011)
SNC	✗	R Cre-dpt rabies	Mouse	DAT-cre (Watabe-Uchida et al., 2012)
	✗	R FG	Rat	(Zahm et al., 2011)
SC	✓	R CTb	Mouse	(Benavidez et al., 2021)
	✓	A PHA-L, AAV	Mouse	(Benavidez et al., 2021)
	✓	A Cav-cre (in M1 or mPFC)	Mouse	<i>En1<sup>Dre</sup>x Dbh<sup>Fipox</sup> RC::RFLTG</i> (Plummer et al., 2020)
	✗	R Cre-dpt rabies	Mouse	vGlut2-cre (Doykos et al., 2020), Gad2-cre (Doykos et al., 2020)
MLR	✓	R Cre-dpt rabies	Rat	ChAT-cre (Huerta-Ocampo et al., 2021)
	✓	R WGA-HRP	Rat	(Semba and Fibiger, 1992)
	✗	R Cre-dpt rabies	Mouse	vGlut2-cre (Dautan et al., 2021; Roseberry et al., 2016), vGat-cre (Roseberry et al., 2016)
	✗	R rAAV2	Mouse	CaMKII-cre (Liu et al., 2022a)
GRN	✗	R CTb	Rat	(Hermann et al., 1997)
	✗	R Cre-dpt rabies	Mouse	CHX10-cre (Cregg et al., 2020)
LGRN	✗	R HRP	Rat	(Andrejik et al., 1981)
	✗	R CTb	Rat	(Sirieix et al., 2012)
	✓	R FG	Rat	(Normandin and Murphy, 2008) <sup>3</sup> , (Van Bockstaele et al., 1989)
	✓	R WGA-HRP	Rat	(Van Bockstaele et al., 1989)
vHPC	A/R	Tracer	Rodent	Transgenic line
M1	✗	A/R		(Bienkowski et al., 2018; Zhao et al., 2020; Luo et al., 2019; Geng et al., 2022)
DS	✗	A/R		(Bienkowski et al., 2018; Lu et al., 2021)

(continued on next page)

Table 2 (continued)

OFC	A/R	Tracer	Rodent	Transgenic line & References
GPe	X	A/R		(Bienkowski et al., 2018; Cui et al., 2021)
STN	X	A/R		(Bienkowski et al., 2018; Cavdar et al., 2018), (Parolari et al., 2021) (Canteras et al., 1990)
SNr	X	A/R		(Bienkowski et al., 2018) <sup>b</sup> (Zahm et al., 2011)
SNc	X	A/R		(Bienkowski et al., 2018; Zahm et al., 2011; Watabe-Uchida et al., 2012)
SC	X	A/R		(Bienkowski et al., 2018; Benavidez et al., 2021; Doykos et al., 2020)
MLR	X	A/R		(Bienkowski et al., 2018; Huerta-Ocampo et al., 2021; Liu et al., 2022a; Semba and Fibiger, 1992)
GRN	X	A/R		(Cregg et al., 2020; Bienkowski et al., 2018) (Hermann et al., 1997)
LGRN	X	A/R		(Bienkowski et al., 2018; Sirieix et al., 2012; Normandin and Murphy, 2008; Van Bockstaele et al., 1989; Andrezik et al., 1981)

X: No projection reported, ✓: Projection mentioned or quantified

Abbreviations: A: Anterograde; R: Retrograde; HRP: Horseradish Peroxidase; WGA: Wheat Germ Agglutinin; CTb: Cholera toxin-b; FG: FluoroGold; rAAV: retro-Adeno-Associated Virus; AAV: Adeno-Associated Virus; PHA-L: Phaseolus vulgaris-leucoagglutinin; BDA: Biotinylated dextran amines; CRF: Corticotropin releasing Hormone; ChAT: choline acetyltransferase; CaMKII: Calcium-calmodulin-dependent protein kinase II; VGlut: Vesicular glutamate transporter; vGat: Vesicular GABA transporter; SERT: Serotonin Transporter; DAT: Dopamine Transporter; Gabrr3: Gamma-Aminobutyric Acid Type A Receptor Subunit Rho3; Gad: Glutamate Decarboxylase; PV: Parvalbumin; Rbp4: Retinol-binding protein 4; Oxt: Oxytocin; AVP: Arginine Vasopressin; SST: Somatostatin; NTS: Neurotensin; Mc3R: Melanocortin 3 Receptor; *Penk*: Proenkephalin; *NPASI*: Neuronal PAS Domain Protein 1

appear in the two main murine atlases. Thus, in this case, the name of the structure was not sufficient to determine the presence of labeling and required visual feedback or written precisions on the localization of the labeling to conclude (Fig. 4, names followed by an asterisk \*). A similar approach was used to differentiate the general name 'Prefrontal Cortex' for rodents, which can refer to the infralimbic (IL) and prelimbic (PL), the cingulate cortex (Cg) and less commonly the orbitofrontal cortex (OFC) (Laubach et al., 2018). However, as these brain regions are anatomically close by and differences in their boundaries exist between atlases, we cannot ensure that some of the anatomical reports do not overlap and may have induced some confounds in our reports (Laubach et al., 2018). The naming 'anterior cingulate cortex', referred to as ACC, was considered specific to the Cg, though it may also refer to the PL in some cases (Laubach et al., 2018).

The main challenge was thus to recognize the appropriate abbreviations, which could vary widely for a specific structure. For example, as stated in the Franklin-Paxinos Atlas, more than 20 different abbreviations exist for the NAc. Abbreviations find their way into the literature outside atlas nomenclature. For example, the insular cortex, is commonly referred to as the IC, though this abbreviation does not exist in the Franklin-Paxinos Atlas or Allen Reference atlas and refers to a completely different structure: the inferior colliculus. Indeed, as stated in (Gehrlach et al., 2020), targeting the subdivisions of the IC as described in the atlases is technically challenging. In contrast, the IC is often differentiated across anterior-posterior levels (Gehrlach et al., 2020; Nicolas et al., 2023), though these differentiations are not present in the atlases. To avoid errors induced by confusing or unusual abbreviations, when we had a doubt, we searched for the presence of the core name in the manuscript or abbreviations.

For Fig. 2 and Fig. 3, we summarized the results of Table 2. Cortical structures were considered glutamatergic, striatal and pallidal structures GABAergic. Hypothalamic and neuromodulatory regions such as the DRN, Ventral Tegmental Area (VTA) and Locus Coeruleus (LC) were not further classified. Fig. 2 highlights the projections that require further investigation (Gray or with transparency). In Fig. 3, only projections that were reported with both anterograde and retrograde tracing were used to build a connectivity map.

For Table 3, we searched for studies that manipulated the activity of our emotion-related structures (lesion studies, pharmacological modulation, manipulation studies) that had projections to the motor system. We thus excluded the ventral hippocampus and the lateral septum from

our search. Most studies investigate those structures in non-motor function. For general locomotor activity, we included studies that tested it only in the non-appetitive, non-aversive tests (open field test, home cage). For spontaneous behavior (turning, vertical activity, jaw movements) and specific motor components such as reaction time, speed, and action selection, we allowed the different behavioral protocols. For other motor behavior, such as coordination and balance, a classic motor test had to be used (rotarod).

### 3. Behavioral evidence for the emotional modulation of movement

Emotion and movement both exert a strong influence on one another and could be seen as an extension of each other or two parallel processes working together. The experience or feeling of an emotion is often accompanied by facial and postural changes, the same way postures and movements can impact our emotional state (Elkjær et al., 2022; Shafir et al., 2016). No perfect consensus has been reached on the definition of emotion (Kleinginna and Kleinginna, 1981) or on models of emotions (Borod, 2000) but many tools exist to study emotions in humans (reviewed in (Maus and Robinson, 2009)) and animals (reviewed in (Lezak et al., 2017); Kuo et al., 2022; Calhoun and Tye, 2015; Scheggi et al., 2018). Overall, it is clear that no individual tool perfectly captures emotional states, and that increasing the number of measures (such as autonomic and behavioral measures) provides a better picture of a given emotional state. In this review, we do not attempt to define emotions and will conceptually use the 2D Valence-Arousal model proposed by Russel (Russell, 1980) combined with the use of neuronal structures as a proxy for emotions.

The inherent relationship between emotions and movement has never been questioned. However, to our knowledge, there has been no exhaustive characterization on arousal- and valence-specific effects on different motor parameters. One could expect behavioral arousal to impact speed, strength, muscle tone and coordination of movements while valence could influence the directionality, the amplitude, and the timing of movements. Or could it be that emotional influence on movements is merely an outcome of facial and postural alterations triggered by the emotion? To what extent can emotional states impact motor learning, decision making, and execution of gross and skilled movements? While our review may not comprehensively address all these inquiries, we anticipate that it will aid in bridging existing

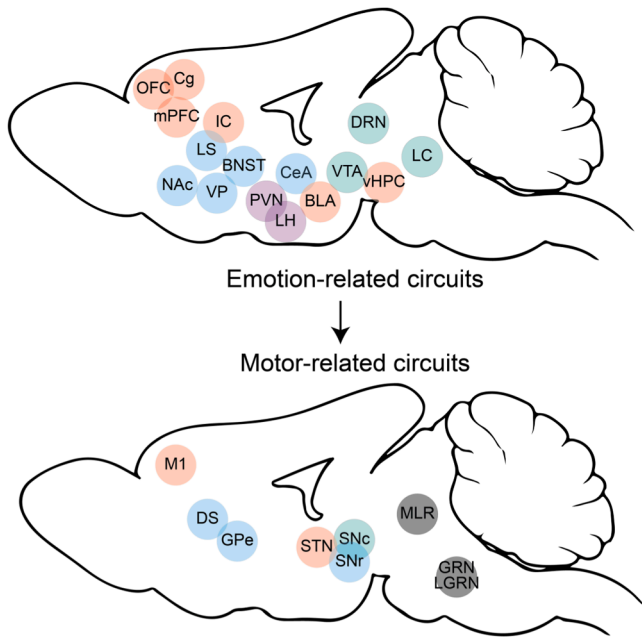

**Fig. 1.** Identification of neural structures involved in emotional processing (top) and motor control (bottom).

knowledge gaps.

To start characterizing the extent of emotional control of motor output, we reviewed behavioral evidence where researchers assessed or induced different emotional states and tested motor performance (Tables 1a-1b). We included only human and rodent studies. We were not able to find articles that assessed the impact of positively-valenced emotions on motor performance, thus the main effects on motor performance are centered around arousal, anxiety, and stress. A study performed on human subjects found that young adults with a high trait anxiety profile performed worse during the whole testing session of a complex motor task requiring hand-eye coordination and fine motor movement than low trait individuals (Jones and Tallarico, 1971). Another study found a correlation between levels of state anxiety and postural control (Ohno et al., 2004). The correlation disappeared when movements were made with eyes closed, suggesting anxiety may modulate oculomotor/orienting processes. State anxiety was found to have a negative impact on driving, with an impaired eye-steering coordination (Wilson et al., 2008). Overall, studies tend to suggest that motor performance, in relation to stress and anxiety, follow an

inverted-U hypothesis, which stipulates that optimal performance occurs at moderate levels of arousal, which varies between individuals (Cox, 1968; Martens and Landers, 1970; Calvo and Alamo, 1987). In these studies, no changes were found in motor tasks requiring only gross motor movements. More importantly, even trained professionals can be subject to emotion-induced changes in motor control. Understanding the emotional control of the motor system is relevant for professions demanding fine motor skills in stressful situations such as musicians, athletes (Beilock and Gray, 2012), police officers (Anderson et al., 2019), soldiers and surgeons (Arora et al., 2010).

Stress or anxiety-induced motor changes are reproducible in rodent studies. Acute, sub-chronic, and chronic behavioral stress induced impairments in skilled forelimb (skilled reaching task) and hindlimb (skilled walking task) movements (Metz et al., 2001, 2005; Kirkland et al., 2008), with an enhanced distance between the hindlimbs, increased angle of foot rotation, decreased stride length and a disrupted interlimb coordination. Diazepam administration, an anxiolytic pharmacological compound, improved skilled reaching performance in an inverted-U dose response (Metz et al., 2005). Even strain-related innate differences in anxiety levels were shown to affect balance and posture in mice (Lepicard et al., 2003). More importantly, administration of anxiolytic (diazepam) or anxiogenic (b-CCM) compound effectively reversed the phenotype, demonstrating a key role for anxiety in mediating postural-related changes.

From Table 1b, we observe that emotional states such as stress and anxiety can affect a wide array of motor components such as timing, coordination, posture, direction, and muscle tone. Some of these effects in humans seem to be related to visuo-motor processing. In most cases, motor performance follows an inverted-U hypothesis in relation to arousal levels. Further studies are required to pinpoint the specific motor change in relation to arousal and/or valence.

The intricate interplay between emotions and movement is of great importance in mental- and motor-dominant pathologies. In recent years, there has been a real effort in recognizing the relevance and presence of non-motor symptoms in motor-dominant pathologies such as PD. Non-motor symptoms such as anxiety and depression strongly impair the quality of life of patients (Blundell et al., 2023) and are major non-motor symptoms in PD (Chaudhuri et al., 2006; Chen and Marsh, 2014). They occur before the onset of motor deficits (Shiba et al., 2000). The origin and role of non-motor symptoms such as anxiety in motor pathologies remains to be understood. Some studies point out anxiety as a risk factor for PD (Weisskopf et al., 2003; Lin et al., 2015) or as part of the pathophysiology of the disease (Martínez-Martín and Damián, 2010). In most cases, emotional disturbance has been determined to be an aggravating factor for motor (Ehgoetz Martens et al., 2018; Dissanayaka et al., 2010),

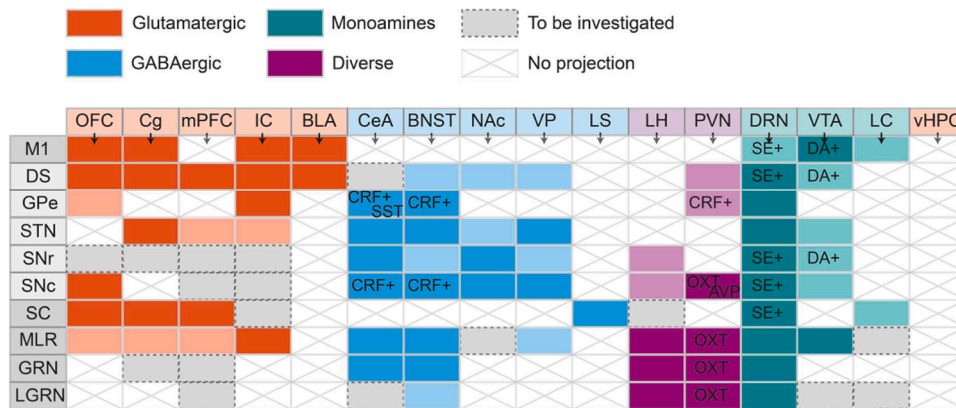

**Fig. 2.** Anatomical projections from emotion-related structures (top) to motor-related structures (left). Colored boxes: Anterograde and retrograde evidence of a projection. More (opaque) or less (transparent) than 75% of the studies listed in Table 2 report this projection. Empty boxes with a cross indicate our results suggest there is no projection between the structures. Gray shaded boxes: Projections to be investigated by further studies. Colors indicate the putative neurotransmitter used. Orange: Glutamate, Blue: GABA, Green: Monoamines, Purple: Diverse peptides and hormones.

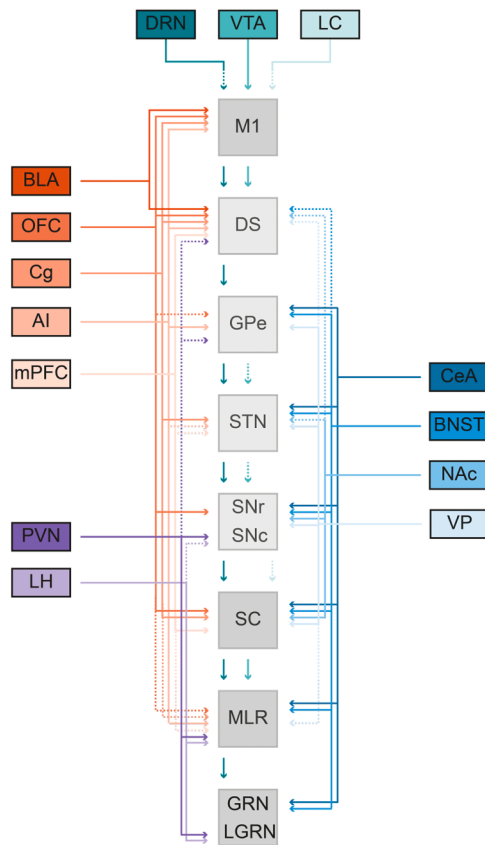

**Fig. 3.** Circuits where emotion (colored) meets motion (gray). All projections reported here had an anterograde and retrograde evidence of a projection. Dotted lines indicate projections for which there were conflicting anatomical results (less than 75% of the studies listed in Table 2 reporting this projection, as in Fig. 2) Colors indicate the putative neurotransmitter used. Orange: Glutamate, Blue: GABA, Green: Monoamines, Purple: Diverse peptides and hormones. The LS and vCA1 were removed from this table for clarity.

gait, (Avanzino et al., 2018) and posture deficits (Jazaeri et al., 2018) in PD. In Table 1c, we review the relationship between emotional disturbance and motor deficits in pathological conditions. Evidence from animal experimental models for motor pathologies indicate stress and anxiety are not only the result of disease progression, even though animal models can mimic some non-motor symptoms (Campos et al., 2013), but can actively worsen the course of the disease and motor deficits. PD is characterized by the neurodegeneration of DA neurons in the substantia nigra (SN). Chronic stress in different animal models for PD accelerates the neurodegeneration of DA neurons in the SN or DA terminals in the striatum and worsens motor deficits (Lauretti et al., 2016; Wu et al., 2016). Chronic corticosterone, a stress related hormone, also increased alpha-synuclein induced Tyrosine Hydroxylase (TH) cell loss in the SN (Burtscher et al., 2019). Imaging studies have confirmed altered activity and connectivity between emotion-related and motor structures in PD (Banwinkler et al., 2022). Thus, chronic emotional states could display activity changes to motor structures that participate in system vulnerability and motor dysfunctions. Understanding the emotion-to-motor neural circuits will provide valuable insight into human behavior and opportunities to enhance performance as well as promise for improving mental and physical health.

To start linking emotion and motion, we explored the function and connectivity of brain regions known to be involved in emotional processing in relation to motor control.

#### 4. Exploring neuronal circuits that may underlie emotional modulation of movement

Our movements are continuously adapting and re-adjusted to the context and perception of different cues. As emotions affect multiple brain and body processes including visual (Shackman et al., 2011), auditory (Pérez et al., 2013), time (Droit-Volet and Meck, 2007) and proprioceptive (Ackerley et al., 2017) processing, indirect emotional modulation of sensory processing (emotion-sensory-motor) may mimic emotional states in their effect on motor performance. However, given the strong bi-directional relationship between emotion and motion, we made the hypothesis that brain structures involved in emotional regulation would have (1) direct projections with neural circuits of movements and (2) activity-dependent motor-related effects.

Our first goal was to identify the relevant brain structures involved in emotional states in humans and rodents. In humans, brain lesions and functional MRI studies have been key methods to attribute a functional role to specific brain regions (Chen and Glover, 2015; Karnath et al., 2018). Some core nuclei show consistent change in activity following the perception, experience and/or expression of basic emotions such as Joy, Sadness, Fear-surprise and Anger-disgust, namely: the Amygdala, the Insular Cortex (IC), the Cingulate Cortex (Cg), the Orbitofrontal cortex (OFC), the Prefrontal cortex, the Ventral Striatum, VTA and the Hippocampus. While some of these nuclei might have a biased activity in relation to a discrete emotion, there is a general involvement of these structures in emotional processing and not for a specific emotion per se (Lindquist et al., 2012). Functional imaging of patients with neuropsychiatric stress and anxiety disorders also provides information on key brain regions involved in emotional regulation. Accordingly, common brain regions were found to be part of neural circuits of stress and anxiety disorders (Liberzon et al., 2015). In rodents, the study of emotional states is quite complex and usually focused on a binary approach-avoidance behavioral analysis of animal behavior. Neural circuits underlying fear (Tovote et al., 2015), anxiety (Tovote et al., 2015; Xia and Kheirbek, 2020), and reward (Berridge and Kringelbach, 2015) have been at the center of rodent-dissection studies for a few decades and key structures have been identified. Combining human and rodent findings, we identified a total of 16 relevant mouse brain structures involved in emotional processing (Fig. 1a). We excluded thalamic brain regions and the Parabrachial Nuclei from our analysis as their main functions are to relay multimodal information to the brain. To study how emotion-related structures affect motion, we looked for motor-related changes following manipulation of the emotion-related structures (Table 3). We predominantly report locomotor or velocity-related effects. This over-representation of locomotor assessment is explained by the fact that most studies assess locomotor activity but do not explore for fine motor skills, motor learning, and coordination.

To determine how emotions can modify motor output, we investigated the existence of direct monosynaptic anatomical connections between the emotion-related brain structures and neural circuits responsible for movement. There have been extensive studies in the neural circuits responsible for movement (Arber and Costa, 2022) implicating cortical, subcortical, midbrain, brainstem, medullary and cerebellar structures. We restricted our analysis to: the primary Motor Cortex (M1), the Basal Ganglia and Brainstem structures involved in the control of movement (Arber and Costa, 2022) (Fig. 1b). Inputs to cerebellar structures were not investigated, as cerebrum-cerebellar interactions are indirect. However, we believe that clarifying inputs to motor cerebellar nuclei would be extremely relevant in understanding the emotional control of fine motor movements, posture, and balance (Bostan and Strick, 2018).

Table 2 is an exhaustive summary of all the emotion-related structures projections to motor-related nuclei. As anatomical tracing studies are very sensitive to the type of animal line used and the type of tracer in addition to injection site variability, we limited our analysis to rodent

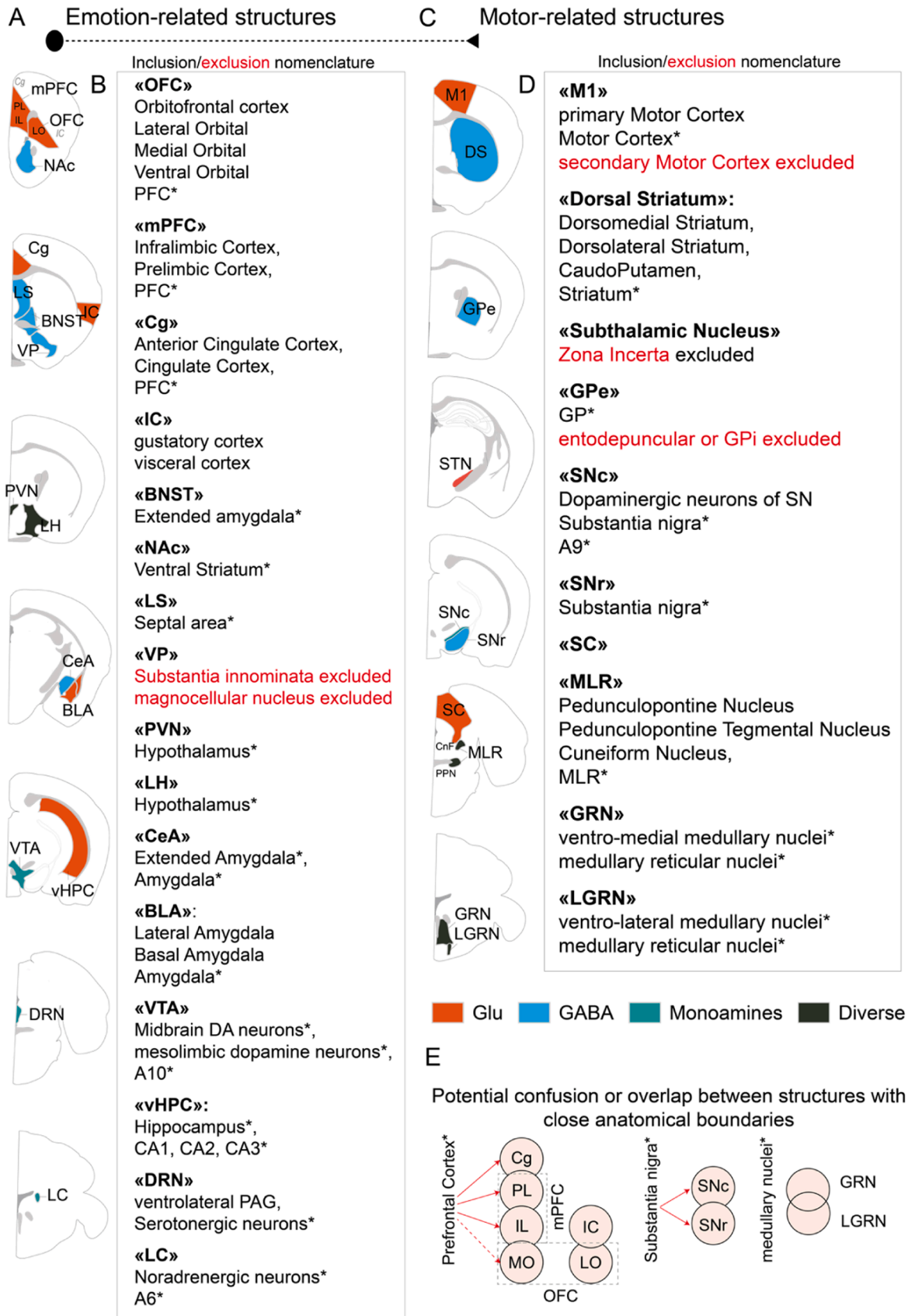

(caption on next page)

**Fig. 4.** General localization and naming of the emotional-related and motor-related brain structures in mice. A & C) Schematic localization of emotional-related (A) or motor-related (C) structures on atlas sections. A representative AP level for each structure was chosen for clarity but they all extend beyond this schematic representation. For clarity, we show the Cg and IC at more posterior levels, though present in the top brain section. Only the Lateral Orbital (LO) and not medial orbital (MO) is shown here, as part of the OFC. Sections are sorted across the anterior (top) - posterior (bottom) axis. B & D) Nomenclature or names that were systematically admitted (black) or excluded (red) as part of the brain region. Names followed by a star required further investigation by the author (visual or written description in the manuscript) to determine their inclusion. E) Main areas of confusion or overlap due to confusing nomenclature or close anatomical boundaries. Overlapping circles are to illustrate the close proximity between structures (such as Cg - PL, and IC-LO at anterior levels of the mouse brain). Confusing nomenclature such as Prefrontal Cortex were attributed to one of the following structures (red arrows) based on visual assessment or precisions in the manuscript. Close attention has been made in those areas, but we cannot exclude some overlap or mismatch in reports made in Table 2 and Table 3. Color codes for structures are to represent the predominant neurotransmission for their long-range projections, with in orange: mainly excitatory glutamatergic projections (cortical-like structures), in blue: mainly inhibitory GABAergic neurotransmission (striatal, septal and pallidal structures), in green: monoaminergic neurotransmission (Dopamine for VTA and SNc, Serotonin for DRN, Noradrenaline for LC), in black: no predominant type of neurotransmission (Both GABA and Glu) and known co-transmission with peptides (hypothalamic areas), monoamines (LGRN: presence of serotonergic neurons), or acetylcholine neuromodulation (PPN).

anatomical studies and included studies that yielded positive and negative anatomical results. We provide details on the line used, the type of tracer, and the consistency of the findings. In Fig. 2 and Fig. 3, we summarize the emotion-to-motor projections. Colored squares indicate we found evidence for both anterograde and retrograde labeling. To report the consistency of the findings, colored squares were set in transparency for anatomical findings with less than 75% of positive results. Interestingly, all emotion-related structures except the vHPC (Bienkowski et al., 2018) and Lateral Septum (LS), have extensive monosynaptic connections to motor neural circuits (Fig. 2, Fig. 3).

#### 4.1. The motor cortex

##### 4.1.1. The primary motor cortex (M1)

The role of the motor cortex in motor control was determined in 1870 after the discovery that electrical stimulations of specific regions in the cerebral cortex were capable of eliciting contralateral movements, with a somatotopic arrangement (i.e. specific regions of the motor cortex represent different body parts) (Gross, 2007). Since then, there have been many studies investigating the organization and specific role of the motor cortex in movement. Neural activity in the motor cortex of humans and primates has been shown to reliably predict upcoming movement trajectory, enough so to open new avenues of motor cortical neuroprosthetics (Georgopoulos and Carpenter, 2015). In humans, emotional stimuli have been shown to enhance motor cortex corticospinal excitability, for both stimuli of positive and negative valence (Hajcak et al., 2007; Qiu et al., 2022; van Loon et al., 2010).

In rodents, light stimulation of M1 can also reliably drives muscle activity (Ayling et al., 2009). However, the functional organization of M1 has been refined over the years and suggests that discrete stimulation of M1 evokes specific sets of movements rather than muscle-based organization (Brown and Teskey, 2014; Hira et al., 2015). M1 is necessary for the learning of skilled motor tasks (Kawai et al., 2015) and controversy remains on its contribution in modulating movement execution parameters (Kawai et al., 2015; Teka et al., 2017).

Similarly to other cortices, M1 has a layered organization (Shipp, 2007), though the presence of a Layer 4 is debated (Barbas and García-Cabezas, 2015). It is mainly composed of pyramidal glutamatergic projection neurons and GABAergic interneurons (Barbas and García-Cabezas, 2015). In rodents, M1 is known to have direct projections to the spinal cord, dorsal striatum, thalamus and contralateral M1 which are mainly located in the deep layers (layer 5/6) of M1 (Oswald et al., 2013; Baker et al., 2018) although cortico-cortical projections are also present in layers 2/3 (Oswald et al., 2013; Muñoz-Castañeda et al., 2021).

In rodents, M1 projection neurons are often broadly separated into two classes of neurons, the extratelencephalic neurons (also referred to as pyramidal tract neurons and can include corticothalamic neurons) and intratelencephalic neurons (Baker et al., 2018). Extratelencephalic neurons populate the deep layers of M1 (layer 5/6) (Muñoz-Castañeda et al., 2021; Zhang et al., 2021) and intratelencephalic neurons are spread across M1 layers 2–6 (Muñoz-Castañeda et al., 2021; Zhang et al., 2021). Importantly, specific marker genes have been shown to be

expressed in M1 neurons, in a layer and/or projection-specific manner (Muñoz-Castañeda et al., 2021). This will provide invaluable help in the future to determine the dynamics and function of these neuronal subpopulations. M1 neurons projecting to the spinal cord have been shown to be necessary for precise but not simplified motor tasks (Serradj et al., 2023). Light inhibition or activation of these neurons during dexterous motor tasks impaired performance. In both simplified and dexterous motor tasks, activation of M1 corticospinal neurons reduced pull force (Serradj et al., 2023).

GABAergic interneurons are diverse and spatially distributed along the different cortical layers (Zhang et al., 2021) of M1. Main GABAergic cell types include somatostatin- and parvalbumin-expressing interneurons, which are preferentially distributed within M1 deep layers (Zhang et al., 2021). Light stimulation of VGaT-expressing neurons in M1, used as a protocol for cortical inactivation, showed disruption in the initiation and modulation of on-going movement (Galiñanes et al., 2018). However, mapping of the precise sites mediating the effects revealed a role for the secondary motor cortex, with no reported effects from M1 inactivation in this task (Galiñanes et al., 2018).

Multiple anatomical tracing studies have investigated brain-wide inputs to the M1, in a cell type or layer specific manner. We recommend following this article (Muñoz-Castañeda et al., 2021) for a complete detailed anatomy of the inputs and outputs of layer-specific, gene-specific and projection-defined M1 neurons (Muñoz-Castañeda et al., 2021). This article was not included in our Table 2 as determining the mouse line and tracer used for a specific structure was difficult and may have led to errors.

























**4.1.1.1. Excitatory inputs to M1.** All cortical structures involved in emotional regulation send projections to the M1 except the medial Prefrontal Cortex (mPFC) although a light projection from the PL has been reported (Muñoz-Castañeda et al., 2021).

The IC, OFC and Cg project to many different cell-types in M1, including Glutamatergic, GABAergic, SOM, PV- expressing cell and CRH neurons (Table 2). The Basolateral Amygdala (BLA), a cortical-like structure, is the only amygdaloid nucleus to project directly to M1 and shares similar inputs than other cortical inputs to M1. In addition, the IC, Cg and BLA also have monosynaptic inputs to deep output neurons of M1 Layer 5 neurons, implying a direct and indirect modulation of output neurons of M1. To our knowledge, the role of these pathways has never been investigated. Electrical stimulation of the anterior mid-Cg in humans induced a variety of responses, including motor responses, which were the first (Caruana et al., 2018) or third (Xue et al., 2023) most frequent response. These motor responses included unilateral or bilateral limb movements. Even though we were not able to find similar studies in rodents, it provides the idea that Cg projections to M1 could facilitate the initiation of forelimb movements.

A role for the BLA to M1 in the consolidation of skilled motor learning has been suggested as post-training stimulation of the BLA accelerated motor skill learning (Bergado et al., 2006).

The BLA is known to enhance different forms of learning and memory consolidation (Chavez et al., 2012). BLA activity is also modulated





















**Table 3**  
Motor effects induced by activity changes in emotion-related structures.

Structure	Manipulation	Motor change	ref
OFC	Lesion	 action sequencing = action selection	(Turner et al., 2022)
OFC	Lesion		(Rudebeck et al., 2008)
Cg	Lesion	 action selection = locomotion	(Rudebeck et al., 2008)
Cg	Chemogenetic I		(Koike et al., 2016)
mPFC	Lesion	 locomotion, = coordination, balance, strength = action sequencing	(Deacon et al., 2003)
mPFC	Lesion		(Turner et al., 2022)
IL	Viral KO GR	 locomotion = locomotion	(McKlveen et al., 2013)
mPFC to STN	Acute light I		(Heikenfeld et al., 2020)
mPFC to STN	Acute light E / I	  Go/No go performance	(Li et al., 2020)
IL	Pharmacological M: μ-OR agonist	 locomotion = locomotion	(Giacomini et al., 2021)
PrL			
pIC	Electrical stimulation		(Alonso-Matielo et al., 2021)
IC	Electrical stimulation		(Dimov et al., 2018)
IC	Chronic electrical stimulation		(García et al., 2015)
pIC	Acute light E	 vertical activity  Jaw movements, ≠ locomotion (  escape,  stopping) = locomotion	(Gehrlach et al., 2019)
aIC	Chemogenetic E / I		(Chen et al., 2022)
Right aIC	Acute light E / I		(Wu et al., 2020)
Left aIC	Acute light E / I	  speed = speed	
r.AIC	Pharmacological M: Oxytocin	 coordination, balance	(Gamal-Eltrabily et al., 2020)
r.AIC	Pharmacological M: Morphine		(Burkey et al., 1996)
IC	Pharmacological M: μ-OR agonist		(Giacomini et al., 2021)
BLA	Lesion	 locomotion in acute stress condition	(Ranjbar et al., 2017)
BLA	Lesion	 locomotion	(Parent et al., 1995)
BLA	Electrical stimulation	 Motor learning	(Bergado et al., 2006)
BLA	Pharmacological E: GABA A antagonist	 locomotion	(Sanders and Shekhar, 1991)
BLA	Acute light E / I	  speed,   arrests	(Botta et al., 2020)
BLA to LH	Acute light E	 locomotion, 	(Chen et al., 2020)

(continued on next page)



Table 3 (continued)

			speed,	
CeA	Lesion		 vertical activity	(Amorapanth et al., 2000)
CeA CRF CeA SST	Acute light E / I Acute light E / I		 Freezing  /	(Fadok et al., 2017)
			 speed to aversive cue	
CeL SST	Acute light E / I		 speed / =  /	(Yu et al., 2016)
CeA	Acute light E		 speed to aversive cue	(Ciocchi et al., 2010)
CeL	Pharmacological I: GABA A agonist		 Freezing	
CeA vGat	Acute light E & Chemogenetic E / I		 Freezing Prey specific context:	(Han et al., 2017)
			 EMG Jaw-closing & Head-direction muscles,	
			 speed	
			 /	
CeA to PCRt	Acute light E		 locomotion and speed Open field: = locomotion	
			 Arrests,	
			 speed,	
			 Jaw movements,	
CeA to PAG	Acute light E Chemogenetic I		 EMG masseter and trapezius  speed	
CeA-MLR	Acute light E / I		 speed Neutral context:	(Roseberry et al., 2019)
CeA to GPe	Inhibition of NT release by TeLC		 speed/ = speed	(Giovanniello et al., 2020)
			 Freezing to CS+ ,	
	Acute light E / I		 Speed to shock, = locomotion	
			 Freezing /	
CeA	Chronic viral overexpression CRF		 Freezing to CS	(Flandreau et al., 2012)
CeA	Pharmacological M: Orexin A		 locomotion  locomotion,	(Olsen et al., 2021)



























(continued on next page)

Table 3 (continued)

BNST	Lesion	Freezing in aversive context = locomotion	(Schulz and Canbeyli, 2000)
BNST	Lesion	= locomotion	(Luyck et al., 2017)
BNST	Electrical stimulation	= locomotion	(Casada and Dafny, 1991)
		locomotion, = speed,	
BNST	Pharmacological I: GABA A agonist	vertical activity	(Fendt et al., 2003)
BNST SST & CRH	Chemogenetic I	Freezing, = locomotion In neutral context: = locomotion & = vertical activity In predator odor context: ≠ locomotion & ≠ vertical activity	(Bruzik et al., 2021)
BNST	Pharmacological M: CRH	locomotion (after 25 min)	(Nijsen et al., 2001)
BNST	Pharmacological M: β-adrenoceptor agonist	= Coordination	(Naka et al., 2013)
NAc D1R NAc D2R	DTR-Ablation	coordination and balance	(Le Merrer et al., 2022)
NAc D1R NAc D2R	Chemogenetic E / I Chemogenetic E / I	skilled motor learning /= locomotion, /= wheel activity	(Zhu et al., 2016)
		locomotion,	
		wheel activity = locomotion	(Soares-Cunha et al., 2016)
NAc D2R NAc	Acute light E / I Pharmacological E: AMPA or NMDA agonist	locomotion	(Wu et al., 1993)
NAc	Pharmacological M: DA reuptake inhibitor	= coordination and balance	(Dias et al., 2015)
NAc	Pharmacological M: Ach agonist, D1R-D2R agonist	contraversive turnings, ≠ stepping & turning patterns	(Saigusa et al., 1995)
NAc.shell	Pharmacological M: Glucagon agonists	= coordination and balance,	(Vestlund and Jerlhag, 2020)
NAc.shell	Pharmacological M: D1R antagonist	execution skilled movement = coordination and balance	(Albrechet-Souza et al., 2013)
NAc.shell	Pharmacological M: GhrelinR antagonist Chronic pharmacological M: GhrelinR antagonist	= coordination and balance, = skilled reaching = coordination and balance, ∞ skilled reaching	(Vestlund et al., 2019)
NAc.shell	Pharmacological M: Orexin A	locomotion	(Thorpe and Kotz, 2005)
VP	Pharmacological E: GABA A antagonist	locomotion, = vertical activity,	(Zahm et al., 2014)
VP	Pharmacological E: GABA A antagonist	abnormal pivots (only when bilateral) = locomotion,	(Reichard et al., 2019)
VP	Pharmacological I: GABA A agonist	pivoting dyskinesia locomotion* , vertical activity* (*only when bilateral)	(Subramanian et al., 2018)























(continued on next page)



Table 3 (continued)

VP	Pharmacological M: D2R agonist	 locomotion ( <i>medium dose</i> ),	(Peczely et al., 2022)
		 locomotion ( <i>high dose</i> )	
LH	Chemogenetic E	 locomotion	(Pei et al., 2019)
LH NTS	Chemogenetic E	 locomotion	(Woodworth et al., 2017)
LH CART	Chemogenetic E	 locomotion	(Farzi et al., 2018)
LH Gal	Chemogenetic E	 locomotion	(Qualls-Creekmore et al., 2017)
LH GABA	Chemogenetic E	 locomotion,	
		 Digging, gnawing	
LH SST	Chemogenetic E	 locomotion,	(Mickelsen et al., 2019)
		 vertical activity,	
		 Digging, gnawing	
LH GABA	Chemogenetic E	 locomotion,	(de Vrind et al., 2019)
LH LepR	Chemogenetic E	 gnawing,	
		 locomotion, = gnawing = locomotion	(Schiffino et al., 2019)
LH LepR	Chemogenetic E / I Acute light E	 locomotion	
LH GAD65	Chemogenetic E / I	 /	(Kosse et al., 2017)
		 locomotion	
LH NTS	Depletion (AAV-DTA) Acute & Chronic Chemogenetic I	 locomotion,	(Brown et al., 2018)
		 wheel activity	
		 locomotion	
LH & LH to PVN	Acute light E	 speed,	(Chen et al., 2020)
		 locomotion,	
		 jumping* ,	
		 vertical activity	
LH orexin	Acute light E / I	 /	(Donegan et al., 2022)
		 Anticipatory skilled movement, = strength	
LH	Pharmacological E: GABA A antagonist	 locomotion,	(Di Scala et al., 1984)

(continued on next page)

Table 3 (continued)

LH	Pharmacological M: Orexin A	 vertical activity  locomotion,	(Kotz et al., 2002)
LH	Pharmacological M: Ach antagonist	 wheel activity = locomotion, = coordination, balance	(Bell and Brown, 1980)
PVN	Lesion	 anticipatory locomotion = locomotion	(Mistlberger and Rusak, 1988)
PVN PVN to PVT	Acute light E Acute light E	 locomotion = locomotion	(Liu et al., 2022b)
PVN	Pharmacological M: THC	 = locomotion	(Verty et al., 2005)
PVN	Pharmacological M: NPY	= locomotion	(van Dijk and Strubbe, 2003)
PVN	Pharmacological M: CRH	 locomotion <i>low dose</i> ,	(Mönnikes et al., 1992)
PVN	Pharmacological M: Orexin A	 locomotion <i>high dose</i>	(Kiwaki et al., 2004)
DRN	Acute light E	 locomotion	(Ohmura et al., 2014)
DRN 5-HT	Acute light E	 locomotion	(Correia et al., 2017)
DRN GABA DRN 5-HT	Acute light E Acute light E	 locomotion  speed in aversive context	(Seo et al., 2019)
VTA	DA lesion Lesion + DA in M1	 speed,  speed in <i>high threat context</i>	(Hosp et al., 2011)
VTA	Pharmacological I: Lidocaine	 Skilled motor learning, = execution = Skilled motor learning <i>Neutral conditions:</i> = locomotion <i>Stress-induced hypocomotion:</i>	(Mortzaei et al., 2019)
VTA TH	Chemogenetic E	 locomotion	(Boekhoudt et al., 2016)
VTA GABA	Acute light E	 locomotion  speed, = rotation	(van Zessen et al., 2012)
VTA & VTA to SNr	Acute light E Chemogenetic E	 locomotion	(He et al., 2021)
VTA	Viral CRHR1 expression	 locomotion	(Dedic et al., 2018)
LC TH to SC	Acute light E Chemogenetic I	 reaction time, = speed	(Li et al., 2018)
LC	Acute light E	 reaction time, = speed ≠ locomotion,	(Carter et al., 2010)
LC	Acute light I	 arrests = locomotion	(Janitzky et al., 2015)

Abbreviations: E: Excitation; I: Inhibition; M: Modulation; , , ≠: significant increase, decrease, difference; = : no significant change; ↘: trend towards a decrease; THC: Δ9-tetrahydrocannabinol; NPY: Neuropeptide Y; CRH/CRF: Corticotropin Releasing Hormone/Factor; DA: Dopamine; DTR: diphtheria toxin receptor; DTA: diphtheria toxin subunit A; R: Receptor; SST: Somatostatin; TH: Tyrosine Hydroxylase; 5-HT: 5-hydroxytryptamine; CS: Conditioned Stimuli; CART: Cocaine- and amphetamine-regulated transcript; LepR: Leptin Receptor; PVT: Paraventricular Thalamus; μ-OR: mu-opioid receptors; NT: Neurotransmitter; TeLC: tetanus toxin light chain; NTS: Neurotensin; PCRT: parvicellular reticular nucleus; PAG: periaqueductal gray

by stress (Sharp, 2017) and can mediate glucocorticoid effects (Roozendaal et al., 1996; Wang et al., 2008). Altogether, it suggests a role for the BLA in mediating the bidirectional effects of glucocorticoids and/or stress in motor skill learning (Liston et al., 2013).

4.1.1.2. *Inhibitory inputs to M1.* Interestingly, we found no evidence for an innervation by the GABAergic striatal (NAc, LS) and pallidal (VP) nuclei to M1 (Table 2). Central Amygdala (CeA) projection to M1 requires further investigation, as reported by (Muñoz-Castañeda et al., 2021) although the projection appeared tracer specific and was not reported in other anatomical tracing studies (Table 2).

4.1.1.3. *Neuromodulatory inputs to M1.* The M1 is also innervated by the three neuromodulatory regions investigated: serotonin from the DRN, NA from the Locus Coeruleus (LC) and DA from the VTA. VTA DA projections to M1 are thought to be crucial for motor skill learning (Hosp et al., 2011). NA signaling in M1 is involved in motor coordination, as the blocking of noradrenergic receptors in M1 induced contralateral mis-steps (Schiemann et al., 2015). For a review on the monoaminergic modulation of motor cortex function, see (Vitrac and Benoit-Marand, 2017).

4.2. The motor Basal Ganglia

The Basal Ganglia is a set of subcortical nuclei responsible for voluntary motor control (Lanciego et al., 2012). Movement disorders and their motor symptoms are associated with basal ganglia dysfunction (DeLong, 1990) such as PD and Huntington’s Disease. We will describe for each basal ganglia nuclei a summary of their known motor function

and their innervation by emotional related structures.

We will briefly mention the DRN here, as it innervates all basal ganglia structures and the other motor-related nuclei listed in this review (Figs. 2–3). Motor research classically focused on dopaminergic neuromodulation but recent years have emphasized the crucial role for serotonin on motor control and its tight regulation of basal ganglia activity (Di Matteo et al., 2008). In PD, serotonin signaling has been implicated in L-DOPA-induced dyskinesia (Carta and Tronci, 2014) and tremors (Loane et al., 2013; Pasquini et al., 2018). The DRN is a serotonergic nucleus with brain-wide innervation to a functionally diverse set of structures, including the basal ganglia. The largest source of basal ganglia serotonergic innervation is in the SN (Parent et al., 2011). We recommend the thorough reviews on the neuromodulation of serotonin to basal ganglia circuits and their associated function in health and disease (Di Matteo et al., 2008; Kawashima, 2018).

4.2.1. Dorsal Striatum (DS)

The DS is the gate of entry of the Basal Ganglia and receives dense cortical inputs. The DS is not restricted to motor behavior and is involved in a wide array of cognitive (Balleine et al., 2007) and emotion-like (Stanley et al., 2021) processes. This implies that some of the projections we report may not participate in motor control. The DS is mainly composed of medium Spiny neurons (MSN), which are the output neurons of the striatum and express either the Dopamine Receptor 1 (D1R) or Dopamine Receptor 2 (D2R), and of interneurons which modulate MSNs activity (Oldenburg and Ding, 2011; Lee et al., 2017). The DS is anatomically and functionally subdivided into the Dorsomedial (DMS) and Dorsolateral (DLS). The DMS is classically associated with goal-directed behavior (Balleine et al., 2009) and is considered the associative part of the striatum, while the DLS with

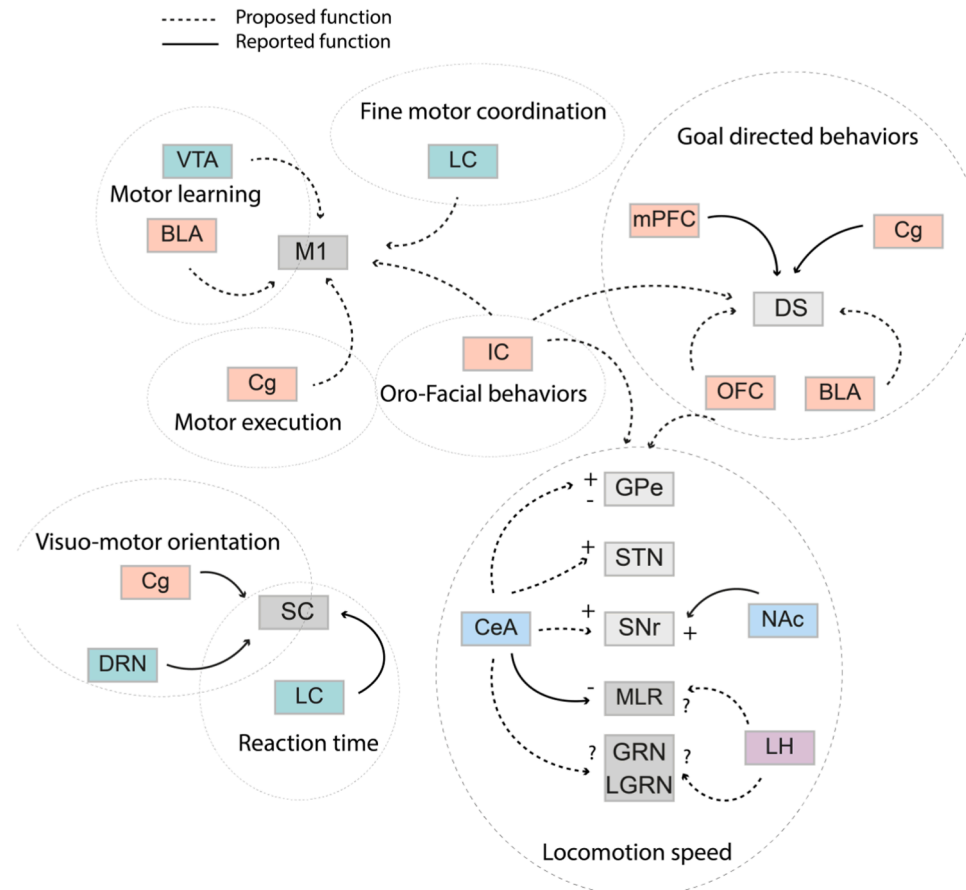

Fig. 5. Piecing the puzzle together, a hint into the emotion-related inputs to motor circuits with the proposed (dashed arrows) or reported (arrows) motor-related function.

habitual behavior (Balleine et al., 2009) and sensory-motor processing. Pure motor-related effects are usually attributed to the DLS but both DMS and DLS have been shown to modulate locomotion and velocity (Barbera et al., 2016; Fobbs et al., 2020), movement sequence (Vandaele et al., 2023) and orientation (Køning et al., 2019). The mPFC, Cg, OFC and BLA have dense projections to the DS (Table 2), and more specifically the DMS. They project to both MSN subtypes and interneuron populations (Table 2).

**4.2.1.1. mPFC & Cg to DS.** mPFC projections to the DMS drive both the acquisition (Hart et al., 2018a) and learning (Fisher et al., 2020; Hart et al., 2018b) of goal directed behavior but also behavioral inhibition (de Kloet et al., 2021; Narayanan et al., 2006). The Cg is involved in behavioral inhibition and action selection processes (Brockett et al., 2020). Some of these effects are mediated via the DMS. The inhibition of Cg projections (also referred to as dorsal mPFC) to the DMS resulted in inhibition deficits with increased premature responses (Terra et al., 2020) in a Go/No-Go task. Overall, the mPFC is seemingly involved in movement initiation, timing and speed while the Cg mainly drives behavioral inhibition and action adaptation (Brockett et al., 2020, 2022) (Table 3). Both the mPFC and Cg are key structures in emotional processing (Etkin et al., 2011) and their projections to the DMS could impact the reaction time (Brockett et al., 2022), the type of movement, or the coordination of a sequence of movements in relation to an affective state.

#### 4.2.2. OFC & BLA to DS

As goal directed behavior is guided by outcome value, the OFC and BLA are well positioned to drive or inhibit goal-directed behavior as they encode stimuli incentive value (Rolls et al., 2020; Gallagher et al., 1999; O'Neill et al., 2018; Schoenbaum et al., 1998) and lesions of either OFC or BLA impairs goal-directed response (Gremel and Costa, 2013; Coutureau et al., 2009). The team of Balleine has investigated the function of BLA to DMS pathway in goal-directed behaviors. In a first study, BLA disconnection to the DMS impaired outcome-devaluation performance (Corbit et al., 2013). However, with specific lesions using viral tools to deplete the BLA to DMS pathway, animals were able to successfully perform the tasks (Fisher et al., 2020). This implies that this pathway is not necessary for goal-directed behaviors. However, stress and anxiety impact goal-directed behavior (Schwabe and Wolf, 2011, 2010). The BLA is a core component of these circuits (Tovote et al., 2015; Calhoon and Tye, 2015; Sharp, 2017) and lead to a hyperexcitability of BLA neurons. Altogether, we can expect that the activation of BLA neurons will impact goal directed behavior, and that this pathway participates in mediating the stress- and/or anxiety-induced impairments of goal-directed behavior.

Furthermore, goal-directed behavior is usually studied using instrumental conditioning and rarely on innate goal-directed behavior. The BLA is well known for its role in exploration, social and maternal behavior. One could expect BLA projections to the DMS to mediate some of this innate behavior because lesions of the BLA impair pup retrieval behavior (Numan et al., 2010) which is considered as a goal directed behavior by these authors, with little impact on nursing behavior.

The subregions of the DMS to which BLA, OFC, Cg and mPFC project have also been associated with visuo-spatial and auditory function due to the strong anatomical convergence of many cortical regions involved in visuo-spatial and auditory processing (Hintiryan et al., 2016). In line with this, a recent study showed that the OFC dynamically encodes a spatial map of future navigational goals (Basu et al., 2021), suggesting that changes in OFC activity in relation to an emotional state could also impact goal-directed trajectories or eye-head movements. As the BLA and OFC share strong bi-directional connectivity (Lichtenberg et al., 2021), they could synergistically provide spatial and valence-saliency information to the DMS to drive behavior. Alterations of OFC and/or BLA activity due to an affective state could thus affect head-body

coordination or direction.

More studies are required to fully comprehend the motor function of BLA and OFC projections to the DMS in execution, initiation, and orientation of movement.

#### 4.2.3. IC to DS

Surprisingly, emotion-related projections to the DLS are restricted to IC and, to a lesser extent, BLA projections. It has dense projections to ventrolateral subregions of the DS, which explains the lack of labeling in some studies targeting the DMS (Table 2, (Smith et al., 2016); Guo et al., 2015). Though a role for the IC and DS on punishment based-avoidance learning (Palminteri et al., 2012) has been suggested, our interest concerned another putative function of this pathway in orofacial control (Hintiryan et al., 2016). The IC integrates visceral-, gustatory-, emotion-related signals (Gehrlach et al., 2020; Livneh and Andermann, 2021), and projects to parts of the ventral DLS to which somatomotor information related to the mouth project (Hintiryan et al., 2016). Furthermore, light stimulation of D1R-expressing MSNs in this region can induce strong contralateral licking in rodents (Lee et al., 2020). This suggests that IC to ventral DS projections may drive orofacial response to consumption or emotional states. Similarly, IC stimulation can trigger jaw movements (Table 3) and IC neuronal activity has been correlated with specific facial expressions (Dolensek et al., 2020).

#### 4.2.4. Neuromodulatory inputs to DS

The DS receives neuromodulatory inputs from the serotonergic DRN and dopaminergic VTA, but we found no evidence for a noradrenergic innervation from the Locus Coeruleus (LC, Table 2). For a review of the possible role for serotonin in DS function, see (Mathur and Lovinger, 2012). Interestingly, even if VTA DA projections to the DS are well established with elegant tracing studies and functional mapping studies (Ioanas et al., 2022), this pathway has not, to the best of our knowledge, been investigated. However, the effects of dopamine on striatal neuronal population and function have been well described (Palmiter, 2008; Chuhma et al., 2023; Heuer et al., 2012).

#### 4.2.5. Other projections to DS

While the cortical inputs to the striatum are dense and consistent across studies, it is not the case for all inputs. Inputs from striatal-like regions such as the NAc, the Bed Nucleus of Stria Terminalis (BNST), CeA, and hypothalamic regions such as the lateral Hypothalamus (LH) and Paraventricular Hypothalamus (PVN) are unclear (Table 2). There is conflicting evidence in retrograde studies, even with the same tracer, and usually little evidence of anterograde labeling. However, as the NAc, BNST and PVN fit our inclusion criteria, they were included in our scheme (Figs. 2–3).

The DS MSNs projects either to the external Globus Pallidus (GPe), called the indirect pathway, or directly to the Substantia nigra *pars reticulata* (SNr)/internal Globus Pallidus (GPi).

#### 4.2.6. Globus pallidus (GP)

In this section we will focus on the GPe as we could not find whole-brain retrograde tracing studies for the *internal segment* of the GP, also named entopeduncular nucleus in rodents.

The GPe had been long considered as just a relay nucleus of the Basal Ganglia but over the years studies have highlighted its complexity and its implication in motor pathologies such as PD and Huntington (Dong et al., 2021). The GPe is a GABAergic structure receiving its main inputs from D2 MSN of the DS and projects to the STN and SNr. Motor functions of the GPe include motor coordination (Jeljeli et al., 1999), locomotion (Aristieta et al., 2021; Lilascharoen et al., 2021), fine motor control (Schneider and Olazabal, 1984) and goal directed and habitual behavior (Lilascharoen et al., 2021; Baker et al., 2023). Recent studies have separated cell-type and projection specific effects of the GPe in motor control. The GPe is mainly composed of prototypic and arkyppallidal neurons, which display distinct electrophysiological, molecular, and

connectivity profiles (Abdi et al., 2015). Prototypic GPe neurons are tonically active with regular high frequency firing, express PV and provide the long-range inputs to the STN and SNr (Mallet et al., 2012). Activation or inhibition of prototypic GPe neurons (PV-expressing) to SNr respectively increases or decreases locomotion speed (Lilascharoen et al., 2021). Prototypic neurons also provide local inhibition on arky-pallidal neurons (FoxP2- or NPAS1- expressing neurons). Arky-pallidal neurons are thought to project only to the DS (Mallet et al., 2012) and provide a “stop” signal to the striatum for action suppression (Mallet et al., 2016). Activation of arky-pallidal neurons through direct light stimulation of FoxP2 neurons or via activation of D2 MSN (disynaptic disinhibition) strongly inhibits locomotion (Aristieta et al., 2021). Interestingly, lesioning arky-pallidal inputs to the DS did not affect spontaneous locomotion and had minimal effects on motor coordination but promoted a shift from a goal-directed task to habitual seeking (Baker et al., 2023).

#### 4.2.7. OFC & IC to GPe

Projections from the lateral OFC have been reported on GPe parvalbumin-expressing (PV) neurons that project to the parafascicular thalamus but not to the SNr, the output neurons of the Basal Ganglia (Lilascharoen et al., 2021). The GPe to parafascicular thalamus pathway has been shown to play a role in reversal learning (Lilascharoen et al., 2021), in line with the previously discussed role for the OFC in goal directed-behavior. The non-cell type specific retrograde whole brain mapping of presynaptic inputs to GPe did not mention OFC projection (Cui et al., 2021). In that study, the gustatory and visceral parts of the IC were part of the main non-striatal inputs to the GPe, which is consistent with IC anterograde tracing studies. The density of the projections is moderate to low in relation to other IC outputs and one study suggested a role for this pathway in speech production (Ghaziri et al., 2018).

#### 4.2.8. CeA-BNST-PVN to GPe

The CeA and BNST could be considered the main emotion-related inputs to the GPe. Interestingly, both the CeA and BNST project to all main neuronal cell types in the GPe, including NPAS1 (Hunt et al., 2018a)- and PV (Lilascharoen et al., 2021)-expressing neurons, and do not target projection-specific GPe neurons (Lilascharoen et al., 2021). We will first discuss CeA inputs to the GPe; CeA-BNST-PVN CRF-specific neurotransmission to the GPe will be discussed in the following section.

The CeA projection to the GPe is now well-defined, as multiple anatomical and electrophysiological studies have found a monosynaptic CeA to GP projection. The CeA is a GABAergic structure that co-expresses a wide array of peptides. Different retrograde and anterograde studies have suggested Corticotropin Releasing Factor (CRF), somatostatin (SST) and Pro-enkephalin (Penk) CeA neurotransmission to the GP. More specifically, GPe-projecting CeA neurons have been shown to be highly co-expressed with SST (~90%) (Giovanniello et al., 2020), and CRF (~50–80%) (Hunt et al., 2018a). Furthermore, both anterograde tracing of Penk (Viden et al., 2022) and SST (Giovanniello et al., 2020) CeA neurons show GPe labeling. A study investigated the molecular organization of the CeA in relation to the type of emotional stimuli they respond to (Kim et al., 2017). Anatomically, SST neurons show some level of colocalization with both CeA CRF (~50%) and Penk neurons, while CRF and Penk do not display any colocalization (Kim et al., 2017). In this elegant study, CeA CRH neurons appear to mediate appetitive signaling and some of the results suggest Penk CeA neurons may convey aversive signaling. This suggests that the GPe can integrate emotional-related stimuli of both valence via the CeA. Furthermore, this could partly explain the discrepancies in the appetitive or defensive behavior reported by manipulations of CeA SST neurons (Kim et al., 2017; Li et al., 2013).

The function of CeA projections to the GPe has already been partially addressed. Permanent inhibition of CeA inputs to GPe decreased the maximum locomotor velocity reached in response to a shock threat and abolished freezing in a fear conditioning protocol (Giovanniello et al.,

2020). Light inhibition and light excitation of GPe-projecting CeA neurons respectively decreased and increased freezing in the same fear paradigm. Interestingly, the same manipulations had no effect on a real place preference test, implying the stimulation is not inherently aversive or appetitive. We suggest that CeA GABAergic projections to arky-pallidal or prototypic GPe neurons could respectively provide “Go” or “Stop” signals in response to appetitive and aversive stimuli (Aristieta et al., 2021; Yu et al., 2016). In line with this hypothesis, light activation of CeA SST neurons in a fear conditioning paradigm prevented the active avoidance response (in this case running), resembling stop-related GPe signaling (Yu et al., 2016). However, chemogenetic activation of CRF-expressing neurons in the CeA exacerbated hyponeuphasia but did not alter general locomotor activity (Kreifeldt et al., 2022).

Furthermore, the CeA with the BNST and PVN constitute three different sources of CRF neuromodulation to the GPe (Hunt et al., 2018b). The GPe shows mRNA expression only for CRHR1 (Van Pett et al., 2000), which are present in 60% of GPe cells and CRH increases neuronal firing of GPe cells *ex vivo* via a CRFR1-mediated postsynaptic action (Hunt et al., 2018b). This suggests a strong influential role for CRF signaling in the GPe in mediating the stress-related motor changes seen in Table 1b.

More studies need to be conducted to determine the impact of these projections on motor control and their pattern of activation in behaving animals.

#### 4.2.9. Subthalamic nucleus (STN)

The STN is at the junction between the midbrain and diencephalon. It has been long considered to be a part of the basal ganglia motor circuitry and is the main glutamatergic input to the GPi and SNr (Robledo and Féger, 1990). Aberrant STN activity is a hallmark of PD (Tai, 2022) and targeting the STN using Deep Brain Stimulation has been an effective treatment for PD motor symptoms (Tödt et al., 2022; Schor et al., 2022). In patients with PD and animal models for it, the STN is overactivated and switches from tonic to burst firing (for a review on STN (Tai, 2022)). Preventing this aberrant activity in animal models for PD, using lesions (Bergman et al., 1990), Deep Brain Stimulation (Valverde et al., 2020), or optogenetics inhibition (Ji et al., 2023) has been found to significantly improve motor symptoms. In physiological condition, the neural activity of the STN is associated with Stop-related signals (Ji et al., 2023; Aron and Poldrack, 2006; Nambu et al., 2002). In line with this, bilateral activation or inhibition (Guillaumin et al., 2021; Xie et al., 2022) of STN activity using optogenetics respectively decreased or increased locomotor activity and activation disrupted motor coordination (Guillaumin et al., 1755). A recent study investigated the pathway-specific effects of photo-stimulation and photoinhibition of STN to SNr and GPi circuits on locomotion (Ji et al., 2023). Photo-stimulation of both pathways resulted in a significant time-locked decrease in locomotor activity, consistent with previous studies. However only photo-inhibition of STN to SNr axons increased locomotion (Ji et al., 2023). This suggests a tonic regulation of locomotor activity through a STN to SNr pathway. In addition to the locomotor effects, unilateral activation or inhibition of the STN induced respectively ipsiversive and contraversive rotations in mice (Guillaumin et al., 1755).

The STN, like the rest of the Basal Ganglia circuitry, has its functional associative, motor, and limbic domains (Wallén-Mackenzie et al., 2020). As it is a small structure and not many detailed whole-brain retrograde tracing analyses exist, we did not differentiate inputs to different STN sub-territories.

The STN receives afferents from cortical glutamatergic structures such as the Cg, mPFC and IC, and GABAergic structures such as the BNST, CeA, NAc or the VP (Table 2, Figs. 2–3). The VTA has a light projection to the STN, however evidence (Aransay et al., 2015) hints towards a non-dopaminergic VTA innervation of the STN while the DRN provides serotonergic innervation to the STN. To our surprise, we could not find any circuit-based behavioral studies on these pathways, except one study on mPFC projections to the STN. In this study, activation or

inhibition of mPFC fibers in the STN did not alter anxiety-related behavior nor locomotion, but action selection/decision making performance (Heikenfeld et al., 2020). However, this study lacked specificity in the projection target as there are many passing fibers near the STN, so the results could have been confounded or blunted by aspecific modulation of mPFC fibers.

It would be interesting to determine whether GABAergic projections from the CeA, BNST, NAc and VP facilitate movement while glutamatergic inputs from cortical regions might inhibit movement. An imbalance in these excitatory/inhibitory inputs in physiological conditions would result in motor changes.

To gain insight into the neuromodulatory impact of serotonin on the STN, we recommend consulting the following reference (Ugedo and De Durwaerdère, 2021).

#### 4.2.10. Substantia nigra, pars reticulata (SNr)

The SNr is a GABAergic structure and a major output nucleus of the Basal Ganglia. It has descending projections to brainstem motor areas and locomotor regions such as the Pedunculopontine Nucleus (PPN) (Granata and Kitai, 1991), and ascending projections to thalamic regions (McElvain et al., 2021).

The SNr is known to control locomotor activity (Rizzi and Tan, 2019), rotations (Rizzi and Tan, 2019), orienting movements (Hormigo et al., 2021; Villalobos and Basso, 2022), balance (Rizzi and Tan, 2019) but also active avoidance (Hormigo et al., 2016). There have been major recent advances on the motor driven effects of the SNr in a projection- and cell type specific manner. Activation of PV-expressing and vGat-expressing neurons in the SNr both reduce locomotor activity but only activation of vGat-expressing cells affect fine motor coordination (Rizzi and Tan, 2019). Interestingly, the emotion-related structures that project to the SNr are mainly GABAergic (Figs. 2–3) and show locomotor effects when manipulated (summarized in Table 3).

#### 4.2.11. NAc to SNr

The NAc is a striatal structure, with a similar organization to the DS. It is known as the limbic-motor interface in the brain (Mogenson et al., 1980), even though we hope that our review will expand this outdated notion that the NAc is the only limbic-motor relay. The NAc can be subdivided into *core* and *shell* regions. As both subregions can drive motor effects (Heidbreder and Feldon, 1998; Zahm, 1999), we did not differentiate between NAc subregions in Table 2. The NAc is well known to modulate cocaine-induced locomotor activity (Pulvirenti et al., 1991) and can also drive robust rotational behavior (Koshikawa et al., 1996). Indeed, unilateral injections of dopaminergic, cholinergic and AMPA receptor agonist in the NAc drives contralateral rotations (Ikeda et al., 2003; Saigusa et al., 1995) and have differential effects on stepping pattern, implying a control of fine motor movements. The effects of the manipulation of D1R- and D2R-expressing NAc neurons are unclear (Table 3), with some studies reporting changes (Zhu et al., 2016) and others no changes in locomotion (Soares-Cunha et al., 2016). This lack of consistency may be due to the type of manipulation (chemogenetics versus optogenetics) and the lack of specificity in the output target.

Curiously, while a motor role for the NAc to SNr pathway has been long hypothesized, there have been very few studies investigating the motor effects of the NAc in a cell-type and projection specific manner. Anatomical studies indicate it is the *core* region of the NAc that mainly projects to SNr (Zahm et al., 2011; Heimer et al., 1991). One recent study tried to fill in the gap and found that unilateral excitation of D1R-expressing NAc *core* terminals in the SNr induced contralateral rotations while bilateral stimulation increased the speed and distance travelled by the animal (Attachaiapanich et al., 2023). This is in line with expected effects on unilateral or bilateral inhibition of the SNr. Inhibition of this pathway had no effect on general locomotor activity, suggesting it is not tonically active and not involved in on-going locomotion. Given the role for the NAc in motivation (Salamone, 1994), one could expect that inhibition of this pathway would affect

motivation-induced hyperlocomotion. Furthermore, as pharmacological manipulation of the NAc can induce alterations in stepping patterns (Liberzon et al., 2015), this pathway could also alter performance in skilled motor tasks and coordination. Interestingly, manipulation of D2R-expressing NAc neurons did not modulate gross motor behavior (Soares-Cunha et al., 2016) but their deletion has been reported to affect skilled motor learning (Le Merrer et al., 2022).

#### 4.2.12. CeA to SNr

The CeA is another dense source of GABAergic input to the SNr and some of those co-express Penk. The SNr expresses a high density of opioid receptors (Galaj et al., 2020; Tempel and Zukin, 1987) and pharmacological stimulation of these receptors in the SNr elicit rotations and an increase in locomotor activity (Collins et al., 2000). CeA GABAergic inputs to SNr neurons are expected to induce hyperlocomotion (as NAc projections). Thus, Penk release in the SNr could mediate some of the motor changes observed following pharmacological manipulations of opioid receptors in the SNr.

#### 4.2.13. BNST to SNr

BNST CRH neurons have been reported to project to the SNr and retrograde labeling was observed after cre-dependent retrograde tracing of PV neurons in the SNr. However, this projection had not been mentioned in earlier anterograde or retrograde studies (Table 2). Even though these inputs may be similar to CeA, given the lack of insight into BNST motor-related function and this anatomical pathway, further studies are required to hypothesize its function.

#### 4.2.14. LH to SNr

The LH projects to Gad2-expressing but not PV-expressing neurons in the SNr (Liu et al., 2020). The LH has a diverse set of neuronal subpopulations, mainly based on their molecular profile (Mickelsen et al., 2019). Cell-type specific axonal tracing is still lacking and would help understand the behavioral effects observed when manipulated. Nonetheless, we know that part of SNr-projecting LH neurons co-express the Melacortin receptor 3, GABA and other neuropeptides such as Galanin and Neurotensin but not orexin (Pei et al., 2019). Interestingly, a majority of articles report increases (Pei et al., 2019; Di Scala et al., 1984; Kosse et al., 2017; Qualls-Creekmore et al., 2017; Woodworth et al., 2017; Chen et al., 2020) or decreases (Kosse et al., 2017; Bingul et al., 2022; Brown et al., 2018) in locomotor activity following respectively activation or inhibition of LH neurons. These results are in line with calcium imaging of LH GAD65-expressing neurons which display activity patterns correlated with voluntary locomotion (Kosse et al., 2017). These LH GABAergic neurons receive glutamatergic inputs from orexin-expressing LH neurons, which respond to stress (Kosse et al., 2017). Altogether, as both the SNr and LH neurons can drive voluntary locomotion, and anterograde (Pei et al., 2019) and retrograde (Liu et al., 2020) studies report SNr-projecting LH neurons, it suggests a role for the LH to SNr pathway in mediating emotion-related locomotor activity. More studies are required to determine the molecular profile of SNr-projecting LH neurons, the circuit in which it is embedded and its effect on locomotion, rearing and fine motor movements.

#### 4.2.15. VTA to SNr

DA projections from the VTA to the SNr have been shown to increase locomotor activity and rescue chronic-social defeat-induced hypo-locomotion in mice without affecting anxiety-like behavior (He et al., 2021).

#### 4.2.16. VP to SNr

The VP has also been reported to project to the SNr, however these projections require further investigation as many retrograde studies did not mention or report this projection (Table 2).



#### 4.2.17. Substantia nigra, pars compacta (SNc)

The SNc is a midbrain dopaminergic structure part of the Basal Ganglia circuitry. It receives inhibitory projections from the GPe and SNr (Watabe-Uchida et al., 2012) and projects mainly to the DS. The integrity of the SNc is crucial for proper motor control as core motor symptoms of PD are attributed to the neurodegeneration of SNc DA neurons.

SNc DA neurons exhibit specific firing patterns, with low frequency spiking activity followed by bursting activity which are thought to be key for proper action control as they are altered in PD animal models (Chen et al., 2023). However not much is known about the short-term effects of SNc DA neurotransmission contribution to motor control. Recent studies have investigated the temporal dynamics and involvement of SNc DA neurons in physiological conditions during movement. Some studies found that the activity of SNc DA neurons precede movement initiation and both its tonic and phasic activity is related to the vigor of future movements (da Silva et al., 2018). The effect of SNc DA activity during movement is unclear as manipulation of SNc DA neurons during on-going movements had no effect on locomotor activity (da Silva et al., 2018) but modified the kinematics and coordination of movement during a skilled motor task (Bova et al., 2020). Some of the discrepancies listed here may arise from the motor task tested, from spontaneous movements to skilled learnt movements. Overall, it suggests that short term changes in SNc DA activity can modulate fine motor components of movements, such as vigor, timing, and coordination in physiological conditions. Much remains to be understood on how short- or long-term changes in both tonic and burst firing of the SNc affect DS MSN activity and its impact on movement initiation and kinetics. When investigating the inputs to SNc neurons, we were surprised to find such a widespread innervation from emotion-related structures. Watabe-Uchida et al., (Watabe-Uchida et al., 2012) provided a comprehensive mapping of mono-synaptic inputs to SNc DA neurons and while they do report some retrogradely labeled cells from the OFC, the main inputs arose from GABAergic (CeA, BNST, NAc, VP) and neuromodulatory structures (PVN, DRN, VTA), summarized in Figs. 2–3.

We found of interest the dense CRF innervation to the SNc originating from the CeA and BNST but not PVN (Dedic et al., 2018). In SNc DA, urocortin, which is part of the CRF family, has been found to inhibit somatodendritic DA release via CRF-1R (Kim et al., 2009), which could result in a disinhibition of SNc DA activity as somatodendritic release of dopamine in SNc DA neurons has been shown to inhibit SNc DA neurons (Hikima et al., 2021). However, in SNc and VTA DA cells, CRF application has been shown to potentiate inhibitory currents via a CRFR1 dependent mechanism that increases GIRK conductance (Beckstead et al., 2009). In addition to post-synaptic effects of CRH on SNc DA cells, recent studies suggest that CRH modulation of pre-synaptic receptors on GPe-expressing cells in the SN is crucial for the integrity of neuronal transmission. Some of these effects could be mediated in part via the CeA and/or BNST CRH liberation at the level of the SNc. This CRF modulation by CeA and BNST could induce stress-induced fine motor timing, vigor, and coordination changes. In addition, this pathway could also be sensitive to chronic stress. Indeed, chronic stress has been shown to increase both the tonic and bursting activity of SNc DA neurons (Yao et al., 2021) and overexpression of CRF reduces CRF1-expression in the SNc (Korosi et al., 2006).

The PVN innervation to the SNc does not express CRH (Dedic et al., 2018) but OXT (Xiao et al., 2017; Freda et al., 2022; Son et al., 2022) and AVP (Freda et al., 2022). PVN OXT neurons inhibit SNc DA activity via OXT and AVP GPCR receptors (Xiao et al., 2017) but do not co-express GABA (Xiao et al., 2017). Anterograde studies of the PVN using PHA-L (Ranson et al., 1998; Luiten et al., 1985) consistently illustrate and report fibers coursing through the SNc, however they do not mention synaptic terminals. Thus we did not include them in Table 2. Nonetheless, as retrograde studies also report a PVN projection, with tracers that are not uptaken by passing fibers, we believe that the reported coursing fibers also provide synaptic input along the way.

#### 4.3. Motor brainstem nuclei

##### 4.3.1. Superior colliculus (SC)

The SC is a midbrain structure involved in sensorimotor control of eye and head movements for orienting behavior (Isa et al., 2021). The SC integrates information from many areas, including the motor basal ganglia and motor cortical areas and projects back to basal ganglia and downstream motor centers (Benavidez et al., 2021) involved in locomotion such as the PPN and head movements such as the Gigantocellular reticular nucleus (GRN) (Usseglio et al., 2020). Furthermore, the topographic organization of those projections is remarkably similar to the cortico-striatal network. A brain-wide analysis of the SC inputs-outputs revealed functional sub-domains identified based on the convergence of inputs (Benavidez et al., 2021), with strong similarities with rostral-caudal cortical somatotopic map.

Interestingly, the mPFC and OFC are, with M1, the only cortical areas to display bilateral projections to the SC. Information from M1, OFC and mPFC converge in the lateral SC (SCL) (Benavidez et al., 2021) which projects to locomotor (Usseglio et al., 2020; Moore et al., 2014), head orienting (Usseglio et al., 2020; Moore et al., 2014) and orofacial centers (Lauretti et al., 2016) such as the GRN and Paragigantocellular reticular nucleus.

The Cg has ipsilateral projections to all the different SC subregions (Benavidez et al., 2021). Cg to SC pathway has been investigated and has been shown to facilitate ipsiversive orienting actions (Huda et al., 2020) and involved in visually-guided behavior (Hu et al., 2019). Unilateral photoinhibition of the SC decreased contraversive actions and increased ipsiversive actions. Photoinhibition of Cg to SC on the other hand increased contraversive actions and decreased ipsiversive actions.

The only putative GABAergic innervation is from the LS, however these projections appear to be very sparse (Risold and Swanson, 1997; Deng et al., 2019). SOM-expressing neurons in LS has been shown to respond to aversive stimuli (An et al., 2022), but activation of these neurons did not elicit locomotor or anxiety-related behavior (An et al., 2022).

We hypothesize DRN serotonergic projections to SC are involved in modulating visuo-motor processing. DRN GABA neurons are activated during visual looming stimuli while DRN serotonergic neurons are inhibited. DRN GABA neurons received direct inputs from the retinal ganglion cells, that also send collaterals to the SC. Both inhibition of DRN GABA neurons and activation of DRN 5HT neurons impaired visual stimuli response, with decrease velocity during looming. There was no change in velocity after looming presentation (Huang et al., 2017). DRN serotonin has been shown to decrease SC neuronal activity both in vivo and ex-vivo. It further decreases SC responses to visual stimuli or optic chiasma electrical stimulation in vivo (Mooney et al., 1996). Thus, DRN 5HT projections decrease retino-tectal neurotransmission, decrease SC response to visual stimuli and visuo-motor responses to visual looming.

The projection from the LC and SC accelerates visuo-motor responses. Stress enhances visual looming defensive responses, an effect that is mediated by LC TH+ projections to the LC. Activation of LC TH+ terminals in SC decreases the reaction time / latency of looming defensive response, mimicking the stress-related effects. In stressed animals, inhibition of LC TH+ to SC pathway or intra infusions of noradrenergic receptor antagonist in the SC significantly decreased stress-induced acceleration (Li et al., 2018).

##### 4.3.2. Mencephalic locomotor region (MLR)

The MLR is at the junction between the midbrain and hindbrain. It is well known to control gait and locomotion (Josset et al., 2018; Dautan et al., 2021) and includes the PPN and the Cuneiform nucleus (Cnf).

Discovery of these locomotor regions initially resulted from electrical stimulations of different brainstem areas in cats (Shik et al., 1966) and these results were later reproduced in rodents (Skinner and Garcia-Rill, 1984). The MLR is composed of glutamatergic and GABAergic neurons, with also Cholinergic neurons specifically in the PPN (Wang and

Morales, 2009). Cell-type specific activation of those neurons in mice (Roseberry et al., 2016) demonstrated glutamatergic neurons of MLR encode locomotor state and speed and is required during spontaneous locomotor activity. Light activation of these neurons was sufficient to drive robust locomotor activity and increase locomotor velocity while inhibition of these neurons produced opposite effects, with increased stop bouts and decreased velocity. In contrast, light activation of ChAT or GABA MLR neurons could not initiate locomotion but modulated running velocity. ChAT increased it while GABAergic neurons decreased it. Part of those effects could be via local modulation of glutamatergic MLR neurons. While these locomotor effects are quite striking, we would like to point out that MLR motor role encompasses locomotor effects. MLR neurons can also encode forelimb movements such as grooming and handling (Ferreira-Pinto et al., 2021), MLR neurons projecting to SC are recruited during rearing (Ferreira-Pinto et al., 2021) and cholinergic neurons of the MLR have been involved in the control of gait (Lin et al., 2023; Karachi et al., 2010).

Recent studies explored further the implication of the different nuclei in locomotor control. Surprisingly, stimulation of glutamatergic PPN neurons decreased running velocity but in line with MLR-stimulations reported above, glutamatergic CnF drove high-speed synchronized locomotor activity (Dautan et al., 2021; Caggiano et al., 2018; van der Zouwen et al., 2021). The story is more complex nonetheless as long photoinhibition of PPN glutamatergic neurons also slowed down locomotion and induced arrests (Josset et al., 2018) and chemogenetic excitation of bilateral caudal glutamatergic PPN increases locomotion (Masini and Kiehn, 2022). Mapping the inputs-outputs of PPN and CnF glutamatergic neurons showed differential connectivity. The PPN displays broader connectivity to motor Basal Ganglia (Dautan et al., 2021) and receives broader afferences from emotion-related structures such as the amygdala (Caggiano et al., 2018) and BNST (Dautan et al., 2021). Hypothalamic regions seem to innervate both nuclei equally (Dautan et al., 2021; Caggiano et al., 2018). Cortical projections to the MLR seem to be restricted to cholinergic neurons of the PPN (Roseberry et al., 2016; Huerta-Ocampo et al., 2021). However, as most anatomical studies do not differentiate between the PPN and CnF, we did not provide those details in Table 2 or Fig. 2. Overall, The MLR receives inputs from cortical, subcortical, pallidal, hypothalamic and neuromodulatory regions involved in emotional processing (Figs. 2–3) with a differential innervation of GABAergic and Glutamatergic-expressing cells (Hart et al., 2018a). Hypothalamic areas, VTA, and BNST seem to equally project to both cell types while the DRN, seemingly show a preferential innervation to GABAergic MLR neurons and CeA and NAc to glutamatergic MLR neurons. Only the projections from the CeA to the MLR have been investigated in a projection-specific manner. Bilateral light activation of CeA terminals in MLR inhibited MLR glutamatergic neurons and stopped locomotor activity while its inhibition showed no effect on locomotion (Roseberry et al., 2019). This suggests that CeA inputs to MLR are not involved in on-going locomotion and are context specific. This could be one pathway to convey freezing-like behavior observed after CeA excitation (Table 3). Given the complexity of the circuits, and the lack of information on the type of neurotransmission to MLR from LH, PVN, BNST, VTA and DRN, we won't go discuss their individual role.

However, the CeA does not only project to glutamatergic neurons but also to PPN cholinergic neurons (Huerta-Ocampo et al., 2021), suggesting CeA to MLR projections are not restricted to locomotor changes.

#### 4.3.3. Medullary reticular nuclei (GRN – LGRN)

The GRN and LGRN are hindbrain nuclei located in the ventral medulla. They project to the spinal cord cervical, thoracic, and lumbar segments and receive MLR afference. Recent studies provide strong insights on their anatomical and behavioral involvement for locomotion, postural, and orientation control. While the GRN and LGRN are anatomically very close by, they differ in their descending spinal projection pattern and motor responses. GRN neurons predominantly

innervates the ipsilateral spinal cord (Cregg et al., 2020; Lundfald et al., 2007; Liang et al., 2016), and studies suggest they project to pre-motor neurons in the different spinal segments (Cregg et al., 2020; Bouvier et al., 2015). The integrity of the GRN is essential for MLR-induced initiation of locomotion, stop-signals (Usseglio et al., 2020; Bouvier et al., 2015) and ipsiversive spontaneous turning (Usseglio et al., 2020). Studies on the GRN focused mainly on glutamatergic reticulo-spinal neurons, shown to co-express vGlut2, CHX10 and V2a (Lundfald et al., 2007; Bouvier et al., 2015) even though GRN inhibitory neurons also project to the spinal cord (Valencia Garcia et al., 2018; Holstege and Bongers, 1991; Martin et al., 2011) and participate to muscle tone atonia during REM sleep (Dayalu and Albin, 2015). An elegant study identified different spinal-projecting GRN CHX10 neurons that control orientation (C2-projecting) or stop (L2-projecting) locomotor signals (Usseglio et al., 2020). This is consistent with other studies reporting ipsiversive turns (Capelli et al., 2017) and decreased speed following chemogenetic or optogenetic unilateral stimulation of glutamatergic GRN neurons (Cregg et al., 2020). Inhibition of these neurons had opposite effects, with animals displaying contraversive orientation bias and increased speed (Cregg et al., 2020; Bouvier et al., 2015). Furthermore, light stimulation of glutamatergic GRN neurons displays EMG responses in both resting and anesthetized mice and disrupts ipsilateral rhythmic locomotor activity (Cregg et al., 2020; Lemieux and Bretzner, 2019). As the GRN has direct access to spinal motor circuits controlling head, trunk and hindlimb muscles, determining the inputs to those different spinal-projecting neurons is highly relevant. Retrograde anatomical studies of the GRN are rare and very few described whole brain retrogradely labeled cells. Hermann et al., described retrogradely labeled cells in the IC, BNST, CeA, LH, PVN and DRN after injection of CTb in GRN *pars alpha* (Hermann et al., 1997). Monosynaptic retrograde tracing of glutamatergic GRN neurons also finds inputs from the ipsilateral CeA but with no mention of hypothalamic or DRN inputs (Cregg et al., 2020). We also had difficulties in finding anterograde studies assessing caudal ventromedial medulla levels. Thus, we could not provide additional information on PVN or IC putative inputs to the GRN. In a similar fashion, CeA terminals in the GRN were mentioned in a PHA-L study (Wallace et al., 1992) but we could not find studies with a thorough description of those CeA inputs. Given the strong changes in velocity and stop-related effects by CeA or LH manipulations (Table 3), it is likely that some of these motor-related changes are mediated via GRN-projecting CeA or LH neurons. More importantly, as the GRN affects locomotor rhythm and visuo-head-body orientation, dysregulation of its activity via emotional related inputs could mediate emotion-induced impairments in eye-head coordination observed in Table 1.

Inputs to the LGRN are strikingly similar to the GRN (Figs. 2–3), with again retrograde labeling in IC, BNST, CeA, LH, PVN and DRN following CTb injections (Sirieix et al., 2012). These results are consistent with another study using fluorogold (Normandin and Murphy, 2008). The LGRN has bilateral projections (Liang et al., 2016; Capelli et al., 2017) to the spinal cord and unilateral activation of glutamatergic LGRN was sufficient to initiate coordinated locomotion and fast EMG responses in limb muscles (Capelli et al., 2017). Impressively, high intensity light-stimulation of glutamatergic or inhibitory neurons respectively induced high-speed locomotion (> 50 cm/s) or behavioral arrests (<3 cm/s) (Capelli et al., 2017). Those behavioral responses are impressive, as the stimulations were unilateral and evoked coordinated full-body responses. These authors further showed that these glutamatergic LGRN neurons were necessary for high-speed locomotion during treadmill running and MLR-evoked high-speed running. Those emotion-related inputs to LGRN could facilitate or inhibit velocity in response to a specific emotional state. Another possibility is that those inputs mediate jaw-related movements. Indeed, the LGRN directly innervates cranial motor nuclei such as the hypoglossal nucleus (motoneurons innervating the tongue) and trigeminal nucleus (motoneurons that innervate mastication) (Sirieix et al., 2012), manipulation of IC, LH,

CeA can induce jaw-related movements (Table 3) and they are part of neural circuits related to taste (Kayyal et al., 2019), food (Stanley et al., 2011), and prey-hunting (Han et al., 2017).

## 5. Conclusions and future directions

We have provided an exhaustive update of what is known on the behavioral and anatomical emotional modulation of movement. Our study further emphasizes the need to explore these projections, as for most of them, there is a big lack of information on the molecular, anatomical, and behavioral level. In Fig. 5 we summarize the main emotion projections to motor circuits for which there was enough anatomical and behavioral evidence to propose a motor-related function.

However, many other projections lack projection-specific or motor assessment. For example, out of all the projections, we believe the function of the BNST projections to motor-related structures should be investigated. Indeed, we found surprising the lack of motor-related changes following BNST manipulation that we could find (Table 3). Indeed, the BNST shares very similar projections than the CeA (Figs. 2–3) and they are both core components of the extended amygdala but only a motor role for the CeA is clear (Table 3). Similarly, while LH projection-specific locomotor effects should be confirmed, there is not much doubt that most of them can modulate locomotion (Figs. 2–3, Table 3). The oxytocin and vasopressin PVN neurons share common projections with the LH to brainstem motor-related nuclei (Fig. 2), but again, in contrast with the LH, not much is known on the putative motor role of the PVN.

We also find of interest the putative role for the IC and Amygdala in driving facial expressions (Dolensek et al., 2020; Pohl et al., 2013). It is thought the Basal Ganglia is involved in the voluntary control of facial expressions, as they are impacted in PD (Bowers et al., 2006). Facial expressions and postural changes are under-studied in rodents, which is most certainly due to the difficulty of assessing them. However, recent advances in automatic quantification of behavior make this area of study more accessible (Dolensek et al., 2020).

Over the years, there has been many structures that have been associated with emotional processing, some which were not included in our analysis. Of note, the tail of the VTA, also called rostral-medial tegmental nucleus is crucial in the processing of aversive stimuli (Jhou et al., 2009; Vento et al., 2017), can drive motor behavior and controls SNc activity (Bourdy et al., 2014). The claustrum is also another multi-modal processing structure involved in emotional (Niu et al., 2022) and motor (Chevéé et al., 2022) processing. Interestingly, whole brain mapping of claustrum outputs does not show any projections to motor-related structures (B et al., 2018) but densely projects to cortical-emotional related structures such as the BLA, mPFC, Cg, OFC. The claustrum could influence motor control via di-synaptic projections or could mediate motor-induced emotional changes.

In this review we have mentioned but not discussed the putative role of the VP in relation to its motor projections. That is because VP motor-related effects, even though described quite striking in specific conditions, are quite complex and could not be explained by individual projections. Scientists have reported that bilateral but not unilateral VP manipulations can drive atypical abnormal movements (Zahm et al., 2014). Cell type specific manipulation of VP neurons drive strong opposite changes in velocity in response to the valence of the conditioned stimulus (Stephenson-Jones et al., 2020). In neutral or appetitive context, activation or inhibition of VP GABAergic neurons respectively increase or decrease speed and locomotion (Stephenson-Jones et al., 2020; Li et al., 2021). Strikingly, the same activation decreased velocity when avoiding an aversive outcome. Glutamatergic VP neurons have seemingly opposite effects, and can strongly inhibit velocity when activated or inhibited in regards to, respectively, an appetitive or aversive stimuli (Stephenson-Jones et al., 2020). Further projection and cell-type specific studies are required to understand its context-specific motor modulation. Nonetheless, given its connectivity with the STN,

SN and PPN, it is anatomically well placed to shape locomotor activity, turning and stop-related behavior. Interestingly, it does not provide any cholinergic modulation to the motor circuits (Faget et al., 2018).

Our review emphasizes the strong behavioral and anatomical relationship between the emotional and motor system. As mentioned previously, this relationship is bidirectional, and we believe further research should also put in exert the motor to emotional interaction. There are several lines of evidence demonstrating that motion can modulate and or initiate the feeling of an emotion. Studies have mainly focused on the facial feedback hypothesis. Indeed self-generated facial expressions have been recognized to modulate both positive and negative affect (Kleinke et al., 1998) and a large-scale international study confirmed that facial expressions could initiate and amplify feelings of happiness (Coles et al., 2022). Similar emotional changes were observed with postural changes (Duclos et al., 2023; Flack et al., 1999). The neural circuits responsible for motion-induced emotional changes may however not directly include the motor system and may be the sole result of proprioceptive and sensory feedback to the brain. However, during our anatomical investigation, we noticed many of the motor-related structures also had projections back to our emotion-related structures. Of note, MLR, and more specifically PPN (Dautan et al., 2021) projections to amygdala, BNST, hypothalamus, VP, VTA, DRN and LC, SNr projections to neuromodulatory regions such as the VTA, DRN and LC (Liu et al., 2020) and GPe projections to BLA (Saunders et al., 2015). This suggests that motor-induced emotional changes could also be mediated by voluntary movements.

## 6. Limitations

Our review aimed to be comprehensive, though narrative. Our keyword search and methodology may not have captured the full picture and may have overlooked articles on the subject. A lot of caution has been paid in summarizing the anatomical results in the literature. However, the evolution of anatomical terms, numerous abbreviations for a given structure and the close anatomical proximity of some of the structures listed here may have led to confusion and confound. Furthermore, we were very inclusive in our anatomical search and the only restriction was on the use of monosynaptic anatomical tracers. Thus, many of the anterograde approaches reported in Table 2 were not specific for synaptic sites (such as AAVs under the synaptophysin promoter) and some may represent passing fibers reported fluorescence. Similarly, most of the retrograde tracers used in the studies can be uptaken by damaged passing fibers or exhibit tropism for specific cell-types. We thus encourage researchers to use this review as an area of investigation, and encourage future research to fill in the gaps and to supplement the anatomical reports with precise tools, whole-brain mapping studies, and provide functional proof of the proposed emotion-motor pathways.

## Author contributions

A.B. and F.G. wrote the manuscript and A.B. prepared the figures.

## Conflict of interests

The authors declare no conflict of interest.

## Acknowledgments

A.B. is supported by the University of Bordeaux's IdEx "Investments for the Future" program / GPR BRAIN\_2030. This work has received funding from the European Union's Horizon 2020 research and innovation program under grant agreement No 848002. This work was supported by recurrent funding from the University of Bordeaux and the CNRS. We also thank Gilad Silberberg and Adriane Guillaumin and the members of the Georges & Baufreton labs and the AND-PD consortium

members for comments and discussions. We thank Jonathan Braine for proofreading of the manuscript. FG is supported by an EU grant (H2020 848002 AND-PD).

## References

- Abdi, A., et al., 2015. Prototypic and arky pallidal neurons in the dopamine-intact external globus pallidus. *J. Neurosci.* 35, 6667–6688.
- Abrams, R., Taylor, M.A., 1976. Catatonia: a prospective clinical study. *Arch. Gen. Psychiatry* 33, 579–581.
- Ackerley, R., Aimonetti, J.-M., Ribot-Ciscar, E., 2017. Emotions alter muscle proprioceptive coding of movements in humans. *Sci. Rep.* 7, 8465.
- Albrechet-Souza, L., Carvalho, M.C., Brandão, M.L., 2013. D1-like receptors in the nucleus accumbens shell regulate the expression of contextual fear conditioning and activity of the anterior cingulate cortex in rats. *Int. J. Neuropsychopharmacol.* 16, 1045–1057.
- Alonso-Matielo, H., et al., 2021. Electrical stimulation of the posterior insula induces mechanical analgesia in a rodent model of neuropathic pain by modulating GABAergic signaling and activity in the pain circuitry. *Brain Res.* 1754, 147237.
- Amorapanth, P., LeDoux, J.E., Nader, K., 2000. Different lateral amygdala outputs mediate reactions and actions elicited by a fear-arousing stimulus. *Nat. Neurosci.* 3, 74–79.
- An, M., et al., 2022. Lateral septum somatostatin neurons are activated by diverse stressors. *Exp. Neurobiol.* 31, 376–389.
- Anderson, G.S., Di Nota, P.M., Metz, G.A.S., Andersen, J.P., 2019. The impact of acute stress physiology on skilled motor performance: implications for policing. *Front. Psychol.* 10, 2501.
- Andrezik, J.A., Chan-Palay, V., Palay, S.L., 1981. The nucleus paragigantocellularis lateralis in the rat. Demonstration of afferents by the retrograde transport of horseradish peroxidase. *Anat. Embryol. (Berl.)* 161, 373–390.
- Aransay, A., Rodríguez-López, C., García-Amado, M., Clascá, F., Prensá, L., 2015. Long-range projection neurons of the mouse ventral tegmental area: a single-cell axon tracing analysis. *Front. Neuroanat.* 9.
- Arber, S., Costa, R.M., 2022. Networking brainstem and basal ganglia circuits for movement. *Nat. Rev. Neurosci.* 23, 342–360.
- Argaud, S., Vêrin, M., Sauleau, P., Grandjean, D., 2018. Facial emotion recognition in Parkinson's disease: a review and new hypotheses. *Mov. Disord.* 33, 554–567.
- Aristieta, A., et al., 2021. A disinaptic circuit in the globus pallidus controls locomotion inhibition. *Curr. Biol.* 31, 707–721.e7.
- Armstrong, M.J., Okun, M.S., 2020. Diagnosis and treatment of parkinson disease: a review. *JAMA* 323, 548–560.
- Aron, A.R., Poldrack, R.A., 2006. Cortical and subcortical contributions to stop signal response inhibition: role of the subthalamic nucleus. *J. Neurosci.* 26, 2424–2433.
- Arora, S., et al., 2010. The impact of stress on surgical performance: a systematic review of the literature. *Surgery* 147, 318–330.e6.
- Attachapanich, S., Ozawa, T., Macpherson, T., Hikida, T., 2023. Dual roles for nucleus accumbens core dopamine d1-expressing neurons projecting to the substantia nigra pars reticulata in limbic and motor control in male mice. *eNeuro* 10.
- Avanzino, L., Lagravinese, G., Abbruzzese, G., Pelosin, E., 2018. Relationships between gait and emotion in Parkinson's disease: a narrative review. *Gait Posture* 65, 57–64.
- Ayling, O.G.S., Harrison, T.C., Boyd, J.D., Goroshkov, A., Murphy, T.H., 2009. Automated light-based mapping of motor cortex by photoactivation of channelrhodopsin-2 transgenic mice. *Nat. Methods* 6, 219–224.
- Azimi, N., Yadollahikhales, G., Argenti, J.P., Cunningham, M.G., 2017. Discrepancies in stereotaxic coordinate publications and improving precision using an animal-specific atlas. *J. Neurosci. Methods* 284, 15–20.
- B, Z., Hw, D., Hw, T., Li, Z., 2018. Input-output organization of the mouse claustrum. *J. Comp. Neurol.* 526, 2428–2443.
- Bacqué-Cazenave, J., et al., 2020. Serotonin in animal cognition and behavior. *Int. J. Mol. Sci.* 21, 1649.
- Baker, A., et al., 2018. Specialized subpopulations of deep-layer pyramidal neurons in the neocortex: bridging cellular properties to functional consequences. *J. Neurosci.* 38, 5441–5455.
- Baker, M., et al., 2023. External globus pallidus input to the dorsal striatum regulates habitual seeking behavior in male mice. *Nat. Commun.* 14, 4085.
- Balleine, B.W., Delgado, M.R., Hikosaka, O., 2007. The role of the dorsal striatum in reward and decision-making. *J. Neurosci.* 27, 8161–8165.
- Balleine, B.W., Liljeholm, M., Ostlund, S.B., 2009. The integrative function of the basal ganglia in instrumental conditioning. *Behav. Brain Res.* 199, 43–52.
- Bancila, M., et al., 2002. Evidence for a direct projection from the paraventricular nucleus of the hypothalamus to putative serotonergic neurons of the nucleus paragigantocellularis involved in the control of erection in rats. *Eur. J. Neurosci.* 16, 1240–1248.
- Banwinkler, M., Theis, H., Prange, S., van Eimeren, T., 2022. Imaging the limbic system in Parkinson's disease—a review of limbic pathology and clinical symptoms. *Brain Sci.* 12, 1248.
- Barbas, H., García-Cabezas, M.Á., 2015. Motor cortex layer 4: less is more. *Trends Neurosci.* 38, 259–261.
- Barbera, G., et al., 2016. Spatially compact neural clusters in the dorsal striatum encode locomotion relevant information. *Neuron* 92, 202–213.
- Basu, R., et al., 2021. The orbitofrontal cortex maps future navigational goals. *Nature* 599, 449–452.
- Beckstead, M.J., et al., 2009. CRF enhancement of GIRK channel-mediated transmission in dopamine neurons. *Neuropsychopharmacol* 34, 1926–1935.
- Beier, K.T., et al., 2015. Circuit architecture of VTA dopamine neurons revealed by systematic input-output mapping. *Cell* 162, 622–634.
- Beilock, S.L., Gray, R., 2012. Why do athletes choke under pressure? In: Tenenbaum, G., Eklund, R.C. (Eds.), in *Handbook of Sport Psychology*. John Wiley & Sons, Inc., pp. 425–444. <https://doi.org/10.1002/9781118270011.ch19>
- Bell, R., Brown, K., 1980. Shock-induced defensive fighting in the rat: evidence for cholinergic mediation in the lateral hypothalamus. *Pharm. Biochem. Behav.* 12, 487–491.
- Benavidez, N.L., et al., 2021. Organization of the inputs and outputs of the mouse superior colliculus. *Nat. Commun.* 12, 4004.
- Bergado, J.A., Rojas, Y., Capdevila, V., González, O., Almaguer-Melian, W., 2006. Stimulation of the basolateral amygdala improves the acquisition of a motor skill. *Restor. Neurol. Neurosci.* 24, 115–121.
- Bergman, H., Wichmann, T., DeLong, M.R., 1990. Reversal of experimental parkinsonism by lesions of the subthalamic nucleus. *Science* 249, 1436–1438.
- Berk, M.L., Finkelstein, J.A., 1982. Efferent connections of the lateral hypothalamic area of the rat: an autoradiographic investigation. *Brain Res. Bull.* 8, 511–526.
- Berlot, R., Rothwell, J.C., Bhatia, K.P., Kojović, M., 2021. Variability of movement disorders: the influence of sensation, action, cognition, and emotions. *Mov. Disord.* 36, 581–593.
- Berridge, K.C., Kringelbach, M.L., 2015. Pleasure systems in the brain. *Neuron* 86, 646–664.
- Bevan, M.D., Smith, A.D., Bolam, J.P., 1996. The substantia nigra as a site of synaptic integration of functionally diverse information arising from the ventral pallidum and the globus pallidus in the rat. *Neuroscience* 75, 5–12.
- Bevan, M.D., Clarke, N.P., Bolam, J.P., 1997. Synaptic integration of functionally diverse pallidal information in the entopeduncular nucleus and subthalamic nucleus in the rat. *J. Neurosci.* 17, 308–324.
- Bienkowski, M.S., et al., 2018. Integration of gene expression and brain-wide connectivity reveals the multiscale organization of mouse hippocampal networks. *Nat. Neurosci.* 21, 1628–1643.
- Bingul, A., Merlin, S., Carrive, P., Killcross, S., Furlong, T.M., 2022. Targeting the lateral hypothalamus with short hairpin RNAs reduces habitual behaviour following extended instrumental training in rats. *Neurobiol. Learn. Mem.* 193, 107657.
- Bjerke, I.E., et al., 2018. Navigating the murine brain: toward best practices for determining and documenting neuroanatomical locations in experimental studies. *Front. Neuroanat.* 12.
- Blundell, E.K., Grover, L.E., Stott, J., Schrag, A., 2023. The experience of Anxiety for people with Parkinson's disease. *npj Park. Dis.* 9, 1–9.
- Boekhoudt, L., et al., 2016. Chemogenetic activation of dopamine neurons in the ventral tegmental area, but not substantia nigra, induces hyperactivity in rats. *Eur. Neuropsychopharmacol.* 26, 1784–1793.
- Borod, J.C., 2000. *The Neuropsychology of Emotion*. Oxford University Press, USA.
- Bostan, A.C., Strick, P.L., 2018. The basal ganglia and the cerebellum: nodes in an integrated network. *Nat. Rev. Neurosci.* 19, 338–350.
- Botta, P., et al., 2020. An amygdala circuit mediates experience-dependent momentary arrests during exploration. *Cell* 183, 605–619.e22.
- Bourdy, R., et al., 2014. Control of the nigrostriatal dopamine neuron activity and motor function by the tail of the ventral tegmental area. *Neuropsychopharmacol* 39, 2788–2798.
- Bouvier, J., et al., 2015. Descending command neurons in the brainstem that halt locomotion. *Cell* 163, 1191–1203.
- Bova, A., et al., 2020. Precisely timed dopamine signals establish distinct kinematic representations of skilled movements. *eLife* 9, e61591.
- Bowers, D., et al., 2006. Faces of emotion in Parkinson's disease: micro-expressivity and bradykinesia during voluntary facial expressions. *J. Int. Neuropsychol. Soc.* 12, 765–773.
- Brockett, A.T., Tennyson, S.S., deBettencourt, C.A., Gaye, F., Roesch, M.R., 2020. Anterior cingulate cortex is necessary for adaptation of action plans. *Proc. Natl. Acad. Sci.* 117, 6196–6204.
- Brockett, A.T., Tennyson, S.S., deBettencourt, C.A., Kallmyer, M., Roesch, M.R., 2022. Medial prefrontal cortex lesions disrupt prepotent action selection signals in dorsomedial striatum. *Curr. Biol.* 32 (3276–3287), e3.
- Brown, A.R., Teskey, G.C., 2014. Motor cortex is functionally organized as a set of spatially distinct representations for complex movements. *J. Neurosci.* 34, 13574–13585.
- Brown, J., et al., 2018. Lateral hypothalamic area neurotensin neurons are required for control of orexin neurons and energy balance. *Endocrinology* 159, 3158–3176.
- Brown, J.A., et al., 2019. Distinct subsets of lateral hypothalamic neurotensin neurons are activated by leptin or dehydration. *Sci. Rep.* 9, 1873.
- Bruzsik, B., et al., 2021. Neurochemically distinct populations of the bed nucleus of stria terminalis modulate innate fear response to weak threat evoked by predator odor stimuli. *Neurobiol. Stress* 15, 100415.
- Burkey, A.R., Carstens, E., Wenniger, J.J., Tang, J., Jasmin, L., 1996. An opioidergic cortical antinociception triggering site in the agranular insular cortex of the rat that contributes to morphine antinociception. *J. Neurosci.* 16, 6612–6623.
- Burtscher, J., et al., 2019. Chronic corticosterone aggravates behavioral and neuronal symptomatology in a mouse model of alpha-synuclein pathology. *Neurobiol. Aging* 83, 11–20.
- Caggiano, V., et al., 2018. Midbrain circuits that set locomotor speed and gait selection. *Nature* 553, 455–460.
- Calhoon, G.G., Tye, K.M., 2015. Resolving the neural circuits of anxiety. *Nat. Neurosci.* 18, 1394–1404.
- Calvo, M.G., Alamo, L., 1987. Test anxiety and motor performance: the role of muscular and attentional demands. *Int. J. Psychol.* 22, 165–178.

- Campagner, D., et al., 2023. A cortico-collicular circuit for orienting to shelter during escape. *Nature* 613, 111–119.
- Campos, F.L., et al., 2013. Rodent models of Parkinson's disease: beyond the motor symptomatology. *Front. Behav. Neurosci.* 7.
- Canteras, N.S., Shammah-Lagnado, S.J., Silva, B.A., Ricardo, J.A., 1990. Afferent connections of the subthalamic nucleus: a combined retrograde and anterograde horseradish peroxidase study in the rat. *Brain Res.* 513, 43–59.
- Capelli, P., Pivetta, C., Soledad Esposito, M., Arber, S., 2017. Locomotor speed control circuits in the caudal brainstem. *Nature* 551, 373–377.
- Carta, M., Tronci, E., 2014. Serotonin system implication in L-DOPA-induced dyskinesia: from animal models to clinical investigations. *Front. Neurol.* 5, 78.
- Carter, M.E., et al., 2010. Tuning arousal with optogenetic modulation of locus coeruleus neurons. *Nat. Neurosci.* 13, 1526–1533.
- Caruana, F., et al., 2018. Motor and emotional behaviours elicited by electrical stimulation of the human cingulate cortex. *Brain* 141, 3035–3051.
- Casada, J.H., Dafny, N., 1991. Restraint and stimulation of bed nucleus of the stria terminalis produce similar stress-like behaviors. *Brain Res. Bull.* 27, 207–212.
- Cavdar, S., et al., 2018. Afferent projections of the subthalamic nucleus in the rat: emphasis on bilateral and interhemispheric connections. *Acta Neurobiol. Exp. (Wars.)* 78, 251–263.
- Celio, M.R., et al., 2013. Efferent connections of the parvalbumin-positive (PV1) nucleus in the lateral hypothalamus of rodents. *J. Comp. Neurol.* 521, 3133–3153.
- Chandler, D.J., Gao, W.-J., Waterhouse, B.D., 2014. Heterogeneous organization of the locus coeruleus projections to prefrontal and motor cortices. *Proc. Natl. Acad. Sci.* 111, 6816–6821.
- Chang, S., et al., 2022. Tripartite extended amygdala–basal ganglia CRH circuit drives locomotor activation and avoidance behavior. *Sci. Adv.* 8, eabo1023.
- Chavez, C.M., et al., 2012. Amygdala strengthening of cortical memory representations. in *The Amygdala - A Discrete Multitasking Manager*. IntechOpen. <https://doi.org/10.5772/53677>.
- Chen, J.E., Glover, G.H., 2015. Functional magnetic resonance imaging methods. *Neuropsychol. Rev.* 25, 289–313.
- Chen, J.J., Marsh, L., 2014. Anxiety in Parkinson's disease: identification and management. *Ther. Adv. Neurol. Disord.* 7, 52–59.
- Chen, L., et al., 2020. Glutamatergic lateral hypothalamus promotes defensive behaviors. *Neuropharmacology* 178, 108239.
- Chen, X.-Y., Liu, C., Xue, Y., Chen, L., 2023. Changed firing activity of nigra dopaminergic neurons in Parkinson's disease. *Neurochem. Int.* 162, 105465.
- Chen, Y., et al., 2022. An orbitofrontal cortex–anterior insular cortex circuit gates compulsive cocaine use. *Sci. Adv.* 8, eabq5745.
- Chev e, M., Finkel, E.A., Kim, S.-J., O'Connor, D.H., Brown, S.P., 2022. Neural activity in the mouse claustrum in a cross-modal sensory selection task. *Neuron* 110 (486–501), e7.
- Chon, U., Vanselow, D.J., Cheng, K.C., Kim, Y., 2019. Enhanced and unified anatomical labeling for a common mouse brain atlas. *Nat. Commun.* 10, 5067.
- Chowdhury, S., et al., 2019. GABA neurons in the ventral tegmental area regulate non-rapid eye movement sleep in mice. *eLife* 8, e44928.
- Chuhma, N., Oh, S.J., Rayport, S., 2023. The dopamine neuron synaptic map in the striatum. *Cell Rep.* 42.
- Ciocchi, S., et al., 2010. Encoding of conditioned fear in central amygdala inhibitory circuits. *Nature* 468, 277–282.
- Coles, N.A., et al., 2022. A multi-lab test of the facial feedback hypothesis by the Many Smiles Collaboration. *Nat. Hum. Behav.* 6, 1731–1742.
- Collins, R.L., Zavala, A.R., Nazarian, A., McDougall, S.A., 2000.  $\kappa$ -Opioid receptors in the substantia nigra pars reticulata mediate the U-50,488-induced locomotor activity of preweanling rats. *Dev. Brain Res.* 119, 97–103.
- Conio, B., et al., 2020. Opposite effects of dopamine and serotonin on resting-state networks: review and implications for psychiatric disorders. *Mol. Psychiatry* 25, 82–93.
- Corbit, L.H., Leung, B.K., Balleine, B.W., 2013. The role of the amygdala–striatal pathway in the acquisition and performance of goal-directed instrumental actions. *J. Neurosci.* 33, 17682–17690.
- Correia, P.A., et al., 2017. Transient inhibition and long-term facilitation of locomotion by phasic optogenetic activation of serotonin neurons. *eLife* 6, e20975.
- Coutureau, E., Marchand, A.R., Di Scala, G., 2009. Goal-directed responding is sensitive to lesions to the prelimbic cortex or basolateral nucleus of the amygdala but not to their disconnection. *Behav. Neurosci.* 123, 443–448.
- Cox, F.N., 1968. Some relationships between test anxiety, presence or absence of male persons, and boy's performance on a repetitive motor task. *J. Exp. Child Psychol.* 6, 1–12.
- Cregg, J.M., et al., 2020. Brainstem neurons that command mammalian locomotor asymmetries. *Nat. Neurosci.* 23, 730–740.
- Cui, Q., et al., 2021. Striatal direct pathway targets Npas1 + pallidal neurons. *J. Neurosci.* 41, 3966–3987.
- Cummins, G., Zandi, M., Barker, R.A., 2015. Movement disorders and psychiatry. *Neurol. Clin. Pr.* 5, 143–149.
- da Silva, J.A., Tecuapetla, F., Paix o, V., Costa, R.M., 2018. Dopamine neuron activity before action initiation gates and invigorates future movements. *Nature* 554, 244–248.
- Dabrowska, J., Martinon, D., Moaddab, M., Rainnie, D.G., 2016. Targeting corticotropin-releasing factor projections from the oval nucleus of the bed nucleus of the stria terminalis using cell-type specific neuronal tracing studies in mouse and rat brain. *J. Neuroendocrinol.* 28.
- Damasio, A.R., et al., 2000. Subcortical and cortical brain activity during the feeling of self-generated emotions. *Nat. Neurosci.* 3, 1049–1056.
- Dautan, D., et al., 2021. Modulation of motor behavior by the mesencephalic locomotor region. *Cell Rep.* 36.
- Dayalu, P., Albin, R.L., 2015. Huntington disease: pathogenesis and treatment. *Neurol. Clin.* 33, 101–114.
- Deacon, R.M.J., Penny, C., Rawlins, J.N.P., 2003. Effects of medial prefrontal cortex cytotoxic lesions in mice. *Behav. Brain Res.* 139, 139–155.
- Dedic, N., et al., 2018. Chronic CRH depletion from GABAergic, long-range projection neurons in the extended amygdala reduces dopamine release and increases anxiety. *Nat. Neurosci.* 21, 803–807.
- Delaville, C., De Deurwaerdere, P., Benazzouz, A., 2011. Noradrenaline and Parkinson's disease. *Front. Syst. Neurosci.* 5.
- DeLong, M.R., 1990. Primate models of movement disorders of basal ganglia origin. *Trends Neurosci.* 13, 281–285.
- Deng, K., et al., 2019. Whole-brain mapping of projection from mouse lateral septal nucleus. *Biol. Open* 8, bio043554.
- Deniau, J.M., Menetrey, A., Thierry, A.M., 1994. Indirect nucleus accumbens input to the prefrontal cortex via the substantia nigra pars reticulata: a combined anatomical and electrophysiological study in the rat. *Neuroscience* 61, 533–545.
- Di Matteo, V., et al., 2008. Serotonin modulation of the basal ganglia circuitry: therapeutic implication for Parkinson's disease and other motor disorders. In: Di Giovanni, G., Di Matteo, V., Esposito, E. (Eds.), in *Progress in Brain Research*, vol. 172. Elsevier, pp. 423–463.
- Di Scala, G., Schmitt, P., Karli, P., 1984. Flight induced by infusion of bicuculline methiodide into periventricular structures. *Brain Res.* 309, 205–209.
- Dias, E.V., et al., 2015. Nucleus accumbens dopaminergic neurotransmission switches its modulatory action in chronification of inflammatory hyperalgesia. *Eur. J. Neurosci.* 42, 2380–2389.
- Dimov, L.F., et al., 2018. Electrical stimulation of the insular cortex as a novel target for the relief of refractory pain: an experimental approach in rodents. *Behav. Brain Res.* 346, 86–95.
- Dissanayaka, N.N.W., et al., 2010. Anxiety disorders in Parkinson's disease: prevalence and risk factors. *Mov. Disord.* 25, 838–845.
- Dolensek, N., Gehrlach, D.A., Klein, A.S., Gogolla, N., 2020. Facial expressions of emotion states and their neuronal correlates in mice. *Science* 368, 89–94.
- Donegan, D., Peleg-Raibstein, D., Lambercy, O., Burdakov, D., 2022. Anticipatory counteracting of motor challenges by premovement activation of orexin neurons. *PNAS Nexus* 1, pgac240.
- Dong, H.-W., Swanson, L.W., 2003. Projections from the rhomboid nucleus of the bed nuclei of the stria terminalis: Implications for cerebral hemisphere regulation of ingestive behaviors. *J. Comp. Neurol.* 463, 434–472.
- Dong, H.-W., Swanson, L.W., 2004a. Organization of axonal projections from the anterolateral area of the bed nuclei of the stria terminalis. *J. Comp. Neurol.* 468, 277–298.
- Dong, H.-W., Swanson, L.W., 2004b. Projections from bed nuclei of the stria terminalis, posterior division: implications for cerebral hemisphere regulation of defensive and reproductive behaviors. *J. Comp. Neurol.* 471, 396–433.
- Dong, H.-W., Swanson, L.W., 2006a. Projections from bed nuclei of the stria terminalis, dorsomedial nucleus: implications for cerebral hemisphere integration of neuroendocrine, autonomic, and drinking responses. *J. Comp. Neurol.* 494, 75–107.
- Dong, H.-W., Swanson, L.W., 2006a. Projections from bed nuclei of the stria terminalis, anteromedial area: cerebral hemisphere integration of neuroendocrine, autonomic, and behavioral aspects of energy balance. *J. Comp. Neurol.* 494, 142–178.
- Dong, H.-W., Swanson, L.W., 2006b. Projections from bed nuclei of the stria terminalis, magnocellular nucleus: implications for cerebral hemisphere regulation of micturition, defecation, and penile erection. *J. Comp. Neurol.* 494, 108–141.
- Dong, H.-W., Petrovich, G.D., Watts, A.G., Swanson, L.W., 2001. Basic organization of projections from the oval and fusiform nuclei of the bed nuclei of the stria terminalis in adult rat brain. *J. Comp. Neurol.* 436, 430–455.
- Dong, J., Hawes, S., Wu, J., Le, W., Cai, H., 2021. Connectivity and functionality of the globus pallidus externa under normal conditions and Parkinson's disease. *Front. Neural Circuits* 15.
- Doykos, T.K., Gilmer, J.I., Person, A.L., Felsen, G., 2020. Monosynaptic inputs to specific cell types of the intermediate and deep layers of the superior colliculus. *J. Comp. Neurol.* 528, 2254–2268.
- Droit-Volet, S., Meck, W.H., 2007. How emotions colour our perception of time. *Trends Cogn. Sci.* 11, 504–513.
- Ehgoetz Martens, K.A., Silveira, C.R.A., Intzandt, B.N., Almeida, Q.J., 2018. Overload from anxiety: a non-motor cause for gait impairments in Parkinson's disease. *JNP* 30, 77–80.
- Ekorn s, B., Lundervold, A.J., Tjus, T., Heimann, M., 2010. Anxiety disorders in 8-11-year-old children: motor skill performance and self-perception of competence: childhood anxiety disorders. *Scand. J. Psychol.* 51, 271–277.
- Elkj er, E., Mikkelsen, M.B., Michalak, J., Mennin, D.S., O'Toole, M.S., 2022. Expansive and contractive postures and movement: a systematic review and meta-analysis of the effect of motor displays on affective and behavioral responses. *Perspect. Psychol. Sci.* 17, 276–304.
- Etkin, A., Egner, T., Kalisch, R., 2011. Emotional processing in anterior cingulate and medial prefrontal cortex. *Trends Cogn. Sci.* 15, 85–93.
- Fadok, J.P., et al., 2017. A competitive inhibitory circuit for selection of active and passive fear responses. *Nature* 542, 96–100.
- Faget, L., et al., 2018. Opponent control of behavioral reinforcement by inhibitory and excitatory projections from the ventral pallidum. *Nat. Commun.* 9, 849.
- Fanselow, M.S., Dong, H.-W., 2010. Are the dorsal and ventral hippocampus functionally distinct structures? *Neuron* 65, 7.
- Farzi, A., et al., 2018. Arcuate nucleus and lateral hypothalamic CART neurons in the mouse brain exert opposing effects on energy expenditure. *eLife* 7, e36494.

- Fendt, M., Endres, T., Apfelbach, R., 2003. Temporary inactivation of the bed nucleus of the stria terminalis but not of the amygdala blocks freezing induced by trimethylthiazoline, a component of fox feces. *J. Neurosci.* 23, 23–28.
- Feng, Q., et al., 2021. Whole-brain reconstruction of neurons in the ventral pallidum reveals diverse projection patterns. *Front. Neuroanat.* 15.
- Ferreira-Pinto, M.J., et al., 2021. Functional diversity for body actions in the mesencephalic locomotor region. *Cell* 184, 4564–4578.e18.
- Fibiger, H.C., Miller, J.J., 1977. An anatomical and electrophysiological investigation of the serotonergic projection from the dorsal raphe nucleus to the substantia nigra in the rat. *Neuroscience* 2, 975–987.
- Fisher, S.D., Ferguson, L.A., Bertran-Gonzalez, J., Balleine, B.W., 2020. Amygdala-cortical control of striatal plasticity drives the acquisition of goal-directed action. *Curr. Biol.* 30 (4541–4546), e5.
- Flack, W.F., Laird, J.D., Cavallaro, L.A., 1999. Separate and combined effects of facial expressions and bodily postures on emotional feelings. *Eur. J. Soc. Psychol.* 29, 203–217.
- Flandreau, E.L., Ressler, K.J., Owens, M.J., Nemeroff, C.B., 2012. Chronic overexpression of corticotropin-releasing factor from the central amygdala produces HPA axis hyperactivity and behavioral anxiety associated with gene-expression changes in the hippocampus and paraventricular nucleus of the hypothalamus. *Psychoneuroendocrinology* 37, 27–38.
- Floriou-Servou, A., et al., 2018. Distinct proteomic, transcriptomic, and epigenetic stress responses in dorsal and ventral hippocampus. *Biol. Psychiatry* 84, 531–541.
- Fobbs, W.C., et al., 2020. Continuous representations of speed by striatal medium spiny neurons. *J. Neurosci.* 40, 1679–1688.
- Fox, S.H., Chuang, R., Brotchie, J.M., 2009. Serotonin and Parkinson's disease: on movement, mood, and madness. *Mov. Disord.* 24, 1255–1266.
- Freda, S.N., et al., 2022. Brainwide input-output architecture of paraventricular oxytocin and vasopressin neurons. *bioRxiv* 2022. 01. 17. 476652. <https://doi.org/10.1101/2022.01.17.476652>.
- Galaj, E., et al., 2020. Dissecting the role of GABA neurons in the VTA versus SNr in opioid reward. *J. Neurosci.* 40, 8853–8869.
- Galiñanes, G.L., Bonardi, C., Huber, D., 2018. Directional reaching for water as a cortex-dependent behavioral framework for mice. *Cell Rep.* 22, 2767–2783.
- Gallagher, M., McMahan, R.W., Schoenbaum, G., 1999. Orbitofrontal Cortex and Representation of Incentive Value in Associative Learning. *J. Neurosci.* 19, 6610–6614.
- Gamal-Eltrably, M., et al., 2020. The rostral agranular insular cortex, a new site of oxytocin to induce antinociception. *J. Neurosci.* 40, 5669–5680.
- Gao, L., et al., 2022. Single-neuron projectome of mouse prefrontal cortex. *Nat. Neurosci.* 25, 515–529.
- García, R., Zafrá, M.A., Puerto, A., 2015. Rewarding effects of electrical stimulation of the insular cortex: decayed effectiveness after repeated tests and subsequent increase in vertical behavioral activity and conditioned place aversion after naloxone administration. *Neurobiol. Learn. Mem.* 118, 64–73.
- García-Rill, E., Skinner, R.D., Gilmore, S.A., Owings, R., 1983. Connections of the mesencephalic locomotor region (MLR) II. Afferents and efferents. *Brain Res. Bull.* 10, 63–71.
- Geerling, J.C., Shin, J.-W., Chimenti, P.C., Loewy, A.D., 2010. Paraventricular hypothalamic nucleus: axonal projections to the brainstem. *J. Comp. Neurol.* 518, 1460–1499.
- Gehrlach, D.A., et al., 2019. Aversive state processing in the posterior insular cortex. *Nat. Neurosci.* 22, 1424–1437.
- Gehrlach, D.A., et al., 2020. A whole-brain connectivity map of mouse insular cortex. *eLife* 9, e55585.
- Gellner, A.-K., et al., 2022. Stress vulnerability shapes disruption of motor cortical neuroplasticity. *Transl. Psychiatry* 12, 1–13.
- Geng, H.-Y., Arbuthnot, G., Yung, W.-H., Ke, Y., 2022. Long-range monosynaptic inputs targeting apical and basal dendrites of primary motor cortex deep output neurons. *Cereb. Cortex* 32, 3975–3989.
- Georgopoulos, A.P., Carpenter, A.F., 2015. Coding of movements in the motor cortex. *Curr. Opin. Neurobiol.* 33, 34–39.
- Ghaziri, J., et al., 2018. Subcortical structural connectivity of insular subregions. *Sci. Rep.* 8, 8596.
- Giacomini, J.L., Geiduschek, E., Selleck, R.A., Sadeghian, K., Baldo, B.A., 2021. Dissociable control of  $\mu$ -opioid-driven hyperphagia vs. food impulsivity across subregions of medial prefrontal, orbitofrontal, and insular cortex. *Neuropsychopharmacol* 46, 1981–1989.
- Giovannelli, J., et al., 2020. A central amygdala-globus pallidus circuit conveys unconditioned stimulus-related information and controls fear learning. *J. Neurosci.* 40, 9043–9054.
- Glickstein, M., 2000. How are visual areas of the brain connected to motor areas for the sensory guidance of movement? *Trends Neurosci.* 23, 613–617.
- Gonzales, C., Chesselet, M.F., 1990. Amygdaloniigral pathway: an anterograde study in the rat with Phaseolus vulgaris leucoagglutinin (PHA-L). *J. Comp. Neurol.* 297, 182–200.
- Granata, A.R., Kitai, S.T., 1991. Inhibitory substantia nigra inputs to the pedunculopontine neurons. *Exp. Brain Res.* 86, 459–466.
- Gremel, C.M., Costa, R.M., 2013. Orbitofrontal and striatal circuits dynamically encode the shift between goal-directed and habitual actions. *Nat. Commun.* 4, 2264.
- Groenewegen, H.J., Berendse, H.W., Haber, S.N., 1993. Organization of the output of the ventral striatopallidal system in the rat: Ventral pallidal efferents. *Neuroscience* 57, 113–142.
- Groenewold, N.A., et al., 2023. Volume of subcortical brain regions in social anxiety disorder: mega-analytic results from 37 samples in the ENIGMA-Anxiety Working Group. *Mol. Psychiatry* 28, 1079–1089.
- Gross, C.G., 2007. The discovery of motor cortex and its background. *J. Hist. Neurosci.* 16, 320–331.
- Guillaumin, A., Serra, G.P., Georges, F., Wallén-Mackenzie, Å., 2021. Experimental investigation into the role of the subthalamic nucleus (STN) in motor control using optogenetics in mice. *Brain Res.* 1755, 147226.
- Guo, Q., et al., 2015. Whole-brain mapping of inputs to projection neurons and cholinergic interneurons in the dorsal striatum. *PLoS ONE* 10, e0123381.
- Hahn, J.D., Swanson, L.W., 2010. Distinct patterns of neuronal inputs and outputs of the juxtaparaventricular and suprafrontal regions of the lateral hypothalamic area in the male rat. *Brain Res. Rev.* 64, 14–103.
- Hajcak, G., et al., 2007. Emotion facilitates action: a transcranial magnetic stimulation study of motor cortex excitability during picture viewing. *Psychophysiology* 44, 91–97.
- Han, W., et al., 2017. Integrated control of predatory hunting by the central nucleus of the amygdala. *Cell* 168, 311–324.e18.
- Harlé, G., et al., 2017. Repeated corticosterone injections in adult mice alter stress hormonal receptor expression in the cerebellum and motor coordination without affecting spatial learning. *Behav. Brain Res.* 326, 121–131.
- Hart, G., Bradfield, L.A., Balleine, B.W., 2018a. Prefrontal corticostriatal disconnection blocks the acquisition of goal-directed action. *J. Neurosci.* 38, 1311–1322.
- Hart, G., Bradfield, L.A., Fok, S.Y., Chieng, B., Balleine, B.W., 2018b. The bilateral prefronto-striatal pathway is necessary for learning new goal-directed actions. *Curr. Biol.* 28 (2218–2229), e7.
- He, F., et al., 2021. Dopaminergic projection from ventral tegmental area to substantia nigra pars reticulata mediates chronic social defeat stress-induced hypolocomotion. *Mol. Neurobiol.* 58, 5635–5648.
- Heidbreder, C., Feldon, J., 1998. Amphetamine-induced neurochemical and locomotor responses are expressed differentially across the anteroposterior axis of the core and shell subterritories of the nucleus accumbens. *Synapse* 29, 310–322.
- Heikenfeld, C., et al., 2020. Prefrontal - subthalamic pathway supports action selection in a spatial working memory task. *Sci. Rep.* 10, 10497.
- Heimer, L., Zahm, D.S., Churchill, L., Kalivas, P.W., Wohltmann, C., 1991. Specificity in the projection patterns of accumbal core and shell in the rat. *Neuroscience* 41, 89–125.
- Heitmann, C.Y., et al., 2016. Abnormal brain activation and connectivity to standardized disorder-related visual scenes in social anxiety disorder. *Hum. Brain Mapp.* 37, 1559–1572.
- Hemmerle, A.M., Dickerson, J.W., Herman, J.P., Seroogy, K.B., 2014. Stress exacerbates experimental Parkinson's disease. *Mol. Psychiatry* 19, 638–640.
- Henley, S.M.D., et al., 2012. Emotion recognition in Huntington's disease: a systematic review. *Neurosci. Biobehav. Rev.* 36, 237–253.
- Hermann, D.M., Luppi, P.-H., Peyron, C., Hinckel, P., Jouviet, M., 1997. Afferent projections to the rat nuclei raphe magnus, raphe pallidus and reticularis gigantocellularis pars  $\alpha$  demonstrated by iontophoretic application of cholera toxin (subunit  $\beta$ ). *J. Chem. Neuroanat.* 13, 1–21.
- Heuer, A., Smith, G.A., Losos, M.J., Lane, E.L., Dunnett, S.B., 2012. Unilateral nigrostriatal 6-hydroxydopamine lesions in mice I: Motor impairments identify extent of dopamine depletion at three different lesion sites. *Behav. Brain Res.* 228, 30–43.
- Hikima, T., et al., 2021. Activity-dependent somatodendritic dopamine release in the substantia nigra autoinhibits the releasing neuron. *Cell Rep.* 35, 108951.
- Hintiryan, H., et al., 2016. The mouse cortico-striatal projectome. *Nat. Neurosci.* 19, 1100–1114.
- Hintiryan, H., et al., 2021. Connectivity characterization of the mouse basolateral amygdalar complex. *Nat. Commun.* 12, 2859.
- Hira, R., Terada, S.-I., Kondo, M., Matsuzaki, M., 2015. Distinct functional modules for discrete and rhythmic forelimb movements in the mouse motor cortex. *J. Neurosci.* 35, 13311–13322.
- Hirjak, D., Wolf, R.C., Landwehrmeyer, G.B., Northoff, G., 2022. Catatonia: looking back and moving forward. *Brain* 145, 2939–2942.
- Hirschtritt, M.E., et al., 2015. Lifetime prevalence, age of risk, and genetic relationships of comorbid psychiatric disorders in Tourette syndrome. *JAMA Psychiatry* 72, 325–333.
- Holstege, J.C., Bongers, C.M.H., 1991. A glycinergic projection from the ventromedial lower brainstem to spinal motoneurons. An ultrastructural double labelling study in rat. *Brain Res.* 566, 308–315.
- Hoover, W.B., Vertes, R.P., 2011. Projections of the medial orbital and ventral orbital cortex in the rat. *J. Comp. Neurol.* 519, 3766–3801.
- Hormigo, S., Vega-Flores, G., Castro-Alamancos, M.A., 2016. Basal ganglia output controls active avoidance behavior. *J. Neurosci.* 36, 10274–10284.
- Hormigo, S., Zhou, J., Castro-Alamancos, M.A., 2021. Bidirectional control of orienting behavior by the substantia nigra pars reticulata: distinct significance of head and whisker movements. *eNeuro* 8.
- Hosp, J.A., Pektanovic, A., Rioult-Pedotti, M.S., Luft, A.R., 2011. Dopaminergic projections from midbrain to primary motor cortex mediate motor skill learning. *J. Neurosci.* 31, 2481–2487.
- Hosp, J.A., Nolan, H.E., Luft, A.R., 2015. Topography and collateralization of dopaminergic projections to primary motor cortex in rats. *Exp. Brain Res* 233, 1365–1375.
- Hu, F., et al., 2019. Prefrontal corticotectal neurons enhance visual processing through the superior colliculus and pulvinar thalamus. *Neuron* 104, 1141–1152.e4.
- Huang, K.W., et al., 2019. Molecular and anatomical organization of the dorsal raphe nucleus. *eLife* 8, e46464.
- Huang, L., et al., 2017. A retinoraphe projection regulates serotonergic activity and looming-evoked defensive behaviour. *Nat. Commun.* 8, 14908.

- Huda, R., et al., 2020. Distinct prefrontal top-down circuits differentially modulate sensorimotor behavior. *Nat. Commun.* 11, 6007.
- Huerta-Ocampo, I., Dautan, D., Gut, N.K., Khan, B., Mena-Segovia, J., 2021. Whole-brain mapping of monosynaptic inputs to midbrain cholinergic neurons. *Sci. Rep.* 11, 9055.
- Hunt, A.J., et al., 2018a. Paraventricular hypothalamic and amygdalar CRF neurons synapse in the external globus pallidus. *Brain Struct. Funct.* 223, 2685–2698.
- Hunt, A.J., et al., 2018b. Paraventricular hypothalamic and amygdalar CRF neurons synapse in the external globus pallidus. *Brain Struct. Funct.* 223, 2685–2698.
- Husain, M.M., et al., 1991. A magnetic resonance imaging study of putamen nuclei in major depression. *Psychiatry Res.: Neuroimaging* 40, 95–99.
- Ikeda, H., et al., 2003. Role of AMPA and NMDA receptors in the nucleus accumbens shell in turning behaviour of rats: interaction with dopamine receptors. *Neuropharmacology* 44, 81–87.
- Ioanas, H.-I., Saab, B.J., Rudin, M., 2022. Whole-brain opto-fMRI of mouse VTA dopaminergic activation reflects structural projections with small but significant deviations. *Transl. Psychiatry* 12, 1–10.
- Isa, T., Marquez-Legorreta, E., Grillner, S., Scott, E.K., 2021. The tectum/superior colliculus as the vertebrate solution for spatial sensory integration and action. *Curr. Biol.* 31, R741–R762.
- Ito, H., Nagano, M., Suzuki, H., Murakoshi, T., 2010. Chronic stress enhances synaptic plasticity due to disinhibition in the anterior cingulate cortex and induces hyperlocomotion in mice. *Neuropharmacology* 58, 746–757.
- Jadavji, N.M., Metz, G.A., 2008. Sex differences in skilled movement in response to restraint stress and recovery from stress. *Behav. Brain Res.* 195, 251–259.
- Jabusch, H.C., Altenmüller, E., 2014. Anxiety as an Aggravating Factor During Onset of Focal Dystonia in Musicians 7. <https://doi.org/10.21091/mppa.2004.2012>.
- Jadavji, N.M., Kolb, B., Metz, G.A., 2006. Enriched environment improves motor function in intact and unilateral dopamine-depleted rats. *Neuroscience* 140, 1127–1138.
- Janitzky, K., et al., 2015. Optogenetic silencing of locus coeruleus activity in mice impairs cognitive flexibility in an attentional set-shifting task. *Front. Behav. Neurosci.* 9.
- Jazaeri, S.Z., et al., 2018. The effects of anxiety and external attentional focus on postural control in patients with Parkinson's disease. *PLOS ONE* 13, e0192168.
- Jeljeli, M., Strazielle, C., Caston, J., Lalonde, R., 1999. Effects of electrolytic lesions of the lateral pallidum on motor coordination, spatial learning, and regional brain variations of cytochrome oxidase activity in rats. *Behav. Brain Res.* 102, 61–71.
- Jhou, T.C., Fields, H.L., Baxter, M.G., Saper, C.B., Holland, P.C., 2009. The rostromedial tegmental nucleus (RMTg), a GABAergic afferent to midbrain dopamine neurons, encodes aversive stimuli and inhibits motor responses. *Neuron* 61, 786–800.
- Ji, Y.-W., et al., 2023. Differential remodeling of subthalamic projections to basal ganglia output nuclei and locomotor deficits in 6-OHDA-induced hemiparkinsonian mice. *Cell Rep.* 42, 112178.
- Jones, R.W., Tallarico, R.B., 1971. Effects of rigidity and anxiety on pursuit rotor performance. *Percept. Mot. Skills* 32, 227–232.
- Josset, N., et al., 2018. Distinct contributions of mesencephalic locomotor nuclei to locomotor control in the freely behaving mouse. *Curr. Biol.* 28, 884–901.e3.
- Chaudhuri, K.R., Healy, D.G., Schapira, A.H.V., 2006. Non-motor symptoms of Parkinson's disease: diagnosis and management. *Lancet Neurol* 5 (3), 235–245.
- Kandel, E.R., Koester, J.D., Mack, S.H., Siegelbaum, S.A., 2021. Principles of Neural Science, sixth ed. McGraw Hill Professional.
- Karachi, C., et al., 2010. Cholinergic mesencephalic neurons are involved in gait and postural disorders in Parkinson disease. *J. Clin. Invest* 120, 2745–2754.
- Karnath, H.-O., Sperber, C., Rorden, C., 2018. Mapping human brain lesions and their functional consequences. *Neuroimage* 165, 180–189.
- Kawai, R., et al., 2015. Motor cortex is required for learning but not for executing a motor skill. *Neuron* 86, 800–812.
- Kawashima, T., 2018. The role of the serotonergic system in motor control. *Neurosci. Res.* 129, 32–39.
- Kayyal, H., et al., 2019. Activity of insula to basolateral amygdala projecting neurons is necessary and sufficient for taste valence representation. *J. Neurosci.* 39, 9369–9382.
- Kim, J., Zhang, X., Muralidhar, S., LeBlanc, S.A., Tonegawa, S., 2017. Basolateral to central amygdala neural circuits for appetitive behaviors. *Neuron* 93 (1464–1479), e5.
- Kim, Y., Park, M.K., Chung, S., 2009. Regulation of somatodendritic dopamine release by corticotropin-releasing factor via the inhibition of voltage-operated Ca<sup>2+</sup> channels. *Neurosci. Lett.* 465, 31–35.
- Kirkland, S.W., Coma, A.K., Colwell, K.L., Metz, G.A., 2008. Delayed recovery and exaggerated infarct size by post-lesion stress in a rat model of focal cerebral stroke. *Brain Res.* 1201, 151–160.
- Kiwaki, K., Kotz, C.M., Wang, C., Lanningham-Foster, L., Levine, J.A., Orexin, A., 2004. Hypocretin 1 injected into hypothalamic paraventricular nucleus and spontaneous physical activity in rats. *Am. J. Physiol. Endocrinol. Metab.* 286, E551–E559.
- Kleinginna, P.R., Kleinginna, A.M., 1981. A categorized list of emotion definitions, with suggestions for a consensual definition. *Motiv Emot.* 5, 345–379.
- Kleinke, C.L., Peterson, T.R., Rutledge, T.R., 1998. Effects of self-generated facial expressions on mood. *J. Personal. Soc. Psychol.* 74, 272–279.
- Kleven, H., et al., 2023. A neuroscientist's guide to using murine brain atlases for efficient analysis and transparent reporting. *Front. Neuroinf.* 17.
- de Kloet, S.F., et al., 2021. Bi-directional regulation of cognitive control by distinct prefrontal cortical output neurons to thalamus and striatum. *Nat. Commun.* 12, 1994.
- Klug, J.R., et al., 2018. Differential inputs to striatal cholinergic and parvalbumin interneurons imply functional distinctions. *eLife* 7, e35657.
- Klumpp, H., Angstadt, M., Nathan, P.J., Phan, K.L., 2010. Amygdala reactivity to faces at varying intensities of threat in generalized social phobia: An event-related functional MRI study. *Psychiatry Res.: Neuroimaging* 183, 167–169.
- Klumpp, H., Angstadt, M., Phan, K.L., 2012. Insula reactivity and connectivity to anterior cingulate cortex when processing threat in generalized social anxiety disorder. *Biol. Psychol.* 89, 273–276.
- Koike, H., et al., 2016. Chemogenetic inactivation of dorsal anterior cingulate cortex neurons disrupts attentional behavior in mouse. *Neuropsychopharmacol* 41, 1014–1023.
- König, A.B., Ciriachi, C., Gether, U., Rickhag, M., 2019. Chemogenetic targeting of dorsomedial direct-pathway striatal projection neurons selectively elicits rotational behavior in mice. *Neuroscience* 401, 106–116.
- Korosi, A., et al., 2006. Distribution and expression of CRF receptor 1 and 2 mRNAs in the CRF over-expressing mouse brain. *Brain Res.* 1072, 46–54.
- Koshikawa, N., Kitamura, M., Kobayashi, M., Cools, A.R., 1996. Contralateral turning elicited by unilateral stimulation of dopamine D2 and D1 receptors in the nucleus accumbens of rats is due to stimulation of these receptors in the shell, but not the core, of this nucleus. *Psychopharmacol. (Berl.)* 126, 185–190.
- Kosse, C., Schöne, C., Bracey, E., Burdakov, D., 2017. Orexin-driven GAD65 network of the lateral hypothalamus sets physical activity in mice. *Proc. Natl. Acad. Sci. U. S. A.* 114, 4525–4530.
- Kotz, C.M., Teske, J.A., Levine, J.A., Wang, C., 2002. Feeding and activity induced by orexin A in the lateral hypothalamus in rats. *Regul. Pept.* 104, 27–32.
- Kreifeldt, M., et al., 2022. Central amygdala corticotropin-releasing factor neurons promote hyponeophagia but do not control alcohol drinking in mice. *Mol. Psychiatry* 27, 2502–2513.
- Kuo, J.Y., et al., 2022. Using deep learning to study emotional behavior in rodent models. *Front. Behav. Neurosci.* 16, 1044492.
- Lanciego, J.L., Luquin, N., Obeso, J.A., 2012. Functional neuroanatomy of the basal ganglia. *Cold Spring Harb. Perspect. Med.* 2, a009621.
- Laubach, M., Amarante, L.M., Swanson, K., White, S.R., 2018. What, if anything, is rodent prefrontal cortex? *eNeuro* 5.
- Lauretto, E., Di Meco, A., Merali, S., Praticò, D., 2016. Chronic behavioral stress exaggerates motor deficit and neuroinflammation in the MPTP mouse model of Parkinson's disease. *Transl. Psychiatry* 6, e733.
- Le Merrer, J., et al., 2022. Balance between direct and indirect pathways of the nucleus accumbens controls social behavior in mice. *bioRxiv*. <https://doi.org/10.1101/2022.11.28.518147>.
- Lee, J., Wang, W., Sabatini, B.L., 2020. Anatomically segregated basal ganglia pathways allow parallel behavioral modulation. *Nat. Neurosci.* 23, 1388–1398.
- Lee, K., et al., 2017. Parvalbumin interneurons modulate striatal output and enhance performance during associative learning. *Neuron* 93, 1451–1463.e4.
- Leemburg, S., Canonica, T., Luft, A., 2018. Motor skill learning and reward consumption differentially affect VTA activation. *Sci. Rep.* 8, 687.
- Lemieux, M., Bretzneger, F., 2019. Glutamatergic neurons of the gigantocellular reticular nucleus shape locomotor pattern and rhythm in the freely behaving mouse. *PLOS Biol.* 17, e2003880.
- Lepicard, E.M., et al., 2003. Posture and balance responses to a sensory challenge are related to anxiety in mice. *Psychiatry Res.* 118, 273–284.
- Lezak, K.R., Missig, G., Carlezon Jr, W.A., 2017. Behavioral methods to study anxiety in rodents. *Dialog. Clin. Neurosci.* 19, 181–191.
- Li, B., Nguyen, T.P., Ma, C., Dan, Y., 2020. Inhibition of impulsive action by projection-defined prefrontal pyramidal neurons. *Proc. Natl. Acad. Sci.* 117, 17278–17287.
- Li, H., et al., 2013. Experience-dependent modification of a central amygdala fear circuit. *Nat. Neurosci.* 16, 332–339.
- Li, L., et al., 2018. Stress accelerates defensive responses to looming in mice and involves a locus coeruleus-superior colliculus projection. *Curr. Biol.* 28, 859–871.e5.
- Li, Y.-D., et al., 2021. Ventral pallidal GABAergic neurons control wakefulness associated with motivation through the ventral tegmental pathway. *Mol. Psychiatry* 26, 2912–2928.
- Liang, H., Watson, C., Paxinos, G., 2016. Terminations of reticulospinal fibers originating from the gigantocellular reticular formation in the mouse spinal cord. *Brain Struct. Funct.* 221, 1623–1633.
- Liberzon, I., Duval, E., Javanbakht, A., 2015. Neural circuits in anxiety and stress disorders: a focused review. *TCRM* 115. <https://doi.org/10.2147/TCRM.S48528>.
- Lichtenberg, N.T., et al., 2021. The medial orbitofrontal cortex-basolateral amygdala circuit regulates the influence of reward cues on adaptive behavior and choice. *J. Neurosci.* 41, 7267–7277.
- Likhtik, E., Johansen, J.P., 2019. Neuromodulation in circuits of aversive emotional learning. *Nat. Neurosci.* 22, 1586–1597.
- Lilasharoen, V., et al., 2021. Divergent pallidal pathways underlying distinct Parkinsonian behavioral deficits. *Nat. Neurosci.* 24, 504–515.
- Lin, C., Ridder, M.C., Sah, P., 2023. The PPN and motor control: preclinical studies to deep brain stimulation for Parkinson's disease. *Front. Neural Circuits* 17.
- Lin, C.-H., Lin, J.-W., Liu, Y.-C., Chang, C.-H., Wu, R.-M., 2015. Risk of Parkinson's disease following anxiety disorders: a nationwide population-based cohort study. *Eur. J. Neurol.* 22, 1280–1287.
- Lindquist, K.A., Wager, T.D., Kober, H., Bliss-Moreau, E., Barrett, L.F., 2012. The brain basis of emotion: a meta-analytic review. *Behav. Brain Sci.* 35, 121–143.
- Liston, C., et al., 2013. Circadian glucocorticoid oscillations promote learning-dependent synapse formation and maintenance. *Nat. Neurosci.* 16, 698–705.
- Liu, D., et al., 2020. A common hub for sleep and motor control in the substantia nigra. *Science* 367, 440–445.
- Liu, Q.-Q., et al., 2022a. Preferential subcortical collateral projections of pedunculopontine nucleus-targeting cortical pyramidal neurons revealed by brain-wide single fiber tracing. *Mol. Brain* 15, 88.

- Liu, Y., et al., 2022b. Distinct hypothalamic paraventricular nucleus inputs to the cingulate cortex and paraventricular thalamic nucleus modulate anxiety and arousal. *Front. Pharmacol.* 13.
- Liveh, Y., Andermann, M.L., 2021. Cellular activity in insular cortex across seconds to hours: sensations and predictions of bodily states. *Neuron* 109, 3576–3593.
- Loane, C., et al., 2013. Serotonergic loss in motor circuitries correlates with severity of action-postural tremor in PD. *Neurology* 80, 1850–1855.
- Louis, E.D., et al., 2001. Correlates of functional disability in essential tremor: correlates of functional disability in ET. *Mov. Disord.* 16, 914–920.
- Lu, J., et al., 2021. Whole-brain mapping of direct inputs to dopamine D1 and D2 receptor-expressing medium spiny neurons in the posterior dorsomedial striatum. *eNeuro* 8.
- Luiten, P.G.M., Ter Horst, G.J., Karst, H., Steffens, A.B., 1985. The course of paraventricular hypothalamic efferents to autonomic structures in medulla and spinal cord. *Brain Res.* 329, 374–378.
- Lundfeld, L., et al., 2007. Phenotype of V2-derived interneurons and their relationship to the axon guidance molecule EphA4 in the developing mouse spinal cord. *Eur. J. Neurosci.* 26, 2989–3002.
- Luo, P., et al., 2019. Whole brain mapping of long-range direct input to glutamatergic and GABAergic neurons in motor cortex. *Front. Neuroanat.* 13, 44.
- Luyck, K., et al., 2017. Electrical stimulation of the bed nucleus of the stria terminalis reduces anxiety in a rat model. *Transl. Psychiatry* 7, e1033.
- Mallet, N., et al., 2012. Dichotomous organization of the external globus pallidus. *Neuron* 74, 1075–1086.
- Mallet, N., et al., 2016. Arky pallidal cells send a Stop signal to Striatum. *Neuron* 89, 308–316.
- Martens, R., Landers, D.M., 1970. Motor performance under stress: a test of the inverted-U hypothesis. *J. Personal. Soc. Psychol.* 16, 29–37.
- Martin, E.M., et al., 2011. Molecular and neuroanatomical characterization of single neurons in the mouse medullary gigantocellular reticular nucleus. *J. Comp. Neurol.* 519, 2574–2593.
- Martínez-Martín, P., Damián, J., 2010. Depression and anxiety in Parkinson disease. *Nat. Rev. Neurol.* 6, 243–245.
- Masini, D., Kiehn, O., 2022. Targeted activation of midbrain neurons restores locomotor function in mouse models of parkinsonism. *Nat. Commun.* 13, 504.
- Mathur, B.N., Lovinger, D.M., 2012. Serotonergic action on dorsal striatal function. *Park. Relat. Disord.* 18, S129–S131.
- Mauss, I.B., Robinson, M.D., 2009. Measures of emotion: a review. *Cogn. Emot.* 23, 209–237.
- McElvain, L.E., et al., 2021. Specific populations of basal ganglia output neurons target distinct brain stem areas while collateralizing throughout the diencephalon. *Neuron* 109, 1721–1738.e4.
- McKlveen, J.M., et al., 2013. Role of prefrontal cortex glucocorticoid receptors in stress and emotion. *Biol. Psychiatry* 74, 672–679.
- Metz, et al., 2001. The effects of acute and chronic stress on motor and sensory performance in male Lewis rats. *Physiol. Behav.* 72, 29–35.
- Metz, G.A., 2007. Stress as a modulator of motor system function and pathology. *Rev. Neurosci.* 18.
- Metz, G.A., Jadavji, N.M., Smith, L.K., 2005. Modulation of motor function by stress: a novel concept of the effects of stress and corticosterone on behavior. *Eur. J. Neurosci.* 22, 1190–1200.
- Mickelsen, L.E., et al., 2019. Single-cell transcriptomic analysis of the lateral hypothalamic area reveals molecularly distinct populations of inhibitory and excitatory neurons. *Nat. Neurosci.* 22, 642–656.
- Mistlberger, R.E., Rusak, B., 1988. Food-anticipatory circadian rhythms in rats with paraventricular and lateral hypothalamic ablations. *J. Biol. Rhythms* 3, 277–291.
- Mizoguchi, K., Yuzurihara, M., Ishige, A., Sasaki, H., Tabira, T., 2002. Chronic stress impairs rotarod performance in rats: implications for depressive state. *Pharmacol. Biochem. Behav.* 71, 79–84.
- Mo, C., Renoir, T., Hannan, A.J., 2014. Effects of chronic stress on the onset and progression of Huntington's disease in transgenic mice. *Neurobiol. Dis.* 71, 81–94.
- Mogenson, G.J., Jones, D.L., Yim, C.Y., 1980. From motivation to action: functional interface between the limbic system and the motor system. *Prog. Neurobiol.* 14, 69–97.
- Mogenson, G.J., Swanson, L.W., Wu, M., 2023. From nucleus accumbens to globus inominata, and lateral preoptic- area: an anatomical and investigation in the rat'. *J. Neurosci.*
- Mönnikes, H., Heymann-Mönnikes, I., Taché, Y., 1992. CRF in the paraventricular nucleus of the hypothalamus induces dose-related behavioral profile in rats. *Brain Res* 574, 70–76.
- Mooney, R.D., Huang, X., Shi, M.Y., Bennett-Clarke, C.A., Rhoades, R.W., 1996. Serotonin modulates retinotectal and corticotectal convergence in the superior colliculus. *Prog. Brain Res* 112, 57–69.
- Moore, J.D., Kleinfeld, D., Wang, F., 2014. How the brainstem controls orofacial behaviors comprised of rhythmic actions. *Trends Neurosci.* 37, 370–380.
- Mortazaei, S., et al., 2019. Ventral tegmental area inactivation alters hormonal, metabolic, and locomotor responses to inescapable stress. *Arch. Physiol. Biochem* 125, 293–301.
- Muñoz-Castañeda, R., et al., 2021. Cellular anatomy of the mouse primary motor cortex. *Nature* 598, 159–166.
- Muzerelle, A., Scotto-Lomassese, S., Bernard, J.F., Soiza-Reilly, M., Gaspar, P., 2016. Conditional anterograde tracing reveals distinct targeting of individual serotonin cell groups (B5-B9) to the forebrain and brainstem. *Brain Struct. Funct.* 221, 535–561.
- Naka, T., et al., 2013. Activation of  $\beta$ -adrenoceptors in the bed nucleus of the stria terminalis induces food intake reduction and anxiety-like behaviors. *Neuropharmacology* 67, 326–330.
- Nambu, A., Tokuno, H., Takada, M., 2002. Functional significance of the cortico-subthalamo-pallidal 'hyperdirect' pathway. *Neurosci. Res* 43, 111–117.
- Narayanan, N.S., Horst, N.K., Laubach, M., 2006. Reversible inactivations of rat medial prefrontal cortex impair the ability to wait for a stimulus. *Neuroscience* 139, 865–876.
- Nauta, W.J., Smith, G.P., Faull, R.L., Domesick, V.B., 1978. Efferent connections and nigral afferents of the nucleus accumbens septi in the rat. *Neuroscience* 3, 385–401.
- Nicolas, C., et al., 2023. Linking emotional valence and anxiety in a mouse insula-amygdala circuit. *Nat. Commun.* 14, 5073.
- Nijssen, M.J., Croiset, G., Diamant, M., De Wied, D., Wiegant, V.M., 2001. CRH signalling in the bed nucleus of the stria terminalis is involved in stress-induced cardiac vagal activation in conscious rats. *Neuropsychopharmacol* 24, 1–10.
- Niu, M., et al., 2022. Claustrum mediates bidirectional and reversible control of stress-induced anxiety responses. *Sci. Adv.* 8, eabi6375.
- Normandin, J.J., Murphy, A.Z., 2008. Nucleus paragigantocellularis afferents in male and female rats: organization, gonadal steroid receptor expression, and activation during sexual behavior. *J. Comp. Neurol.* 508, 771–794.
- Numan, M., et al., 2010. The importance of the basolateral/basomedial amygdala for goal-directed maternal responses in postpartum rats. *Behav. Brain Res.* 214, 368–376.
- O'Neill, P.-K., Gore, F., Salzman, C.D., 2018. Basolateral amygdala circuitry in positive and negative valence. *Curr. Opin. Neurobiol.* 49, 175–183.
- Ohmura, Y., Tanaka, K.F., Tsunematsu, T., Yamanaka, A., Yoshioka, M., 2014. Optogenetic activation of serotonergic neurons enhances anxiety-like behaviour in mice. *Int. J. Neuropsychopharmacol.* 17, 1777–1783.
- Ohno, H., Wada, M., Saitoh, J., Sunaga, N., Nagai, M., 2004. The effect of anxiety on postural control in humans depends on visual information processing. *Neurosci. Lett.* 364, 37–39.
- Oldenburg, I.A., Ding, J.B., 2011. Cholinergic modulation of synaptic integration and dendritic excitability in the striatum. *Curr. Opin. Neurobiol.* 21, 425–432.
- Olsen, N., Furlong, T.M., Carrive, P., 2021. Behavioural and cardiovascular effects of orexin-A infused into the central amygdala under basal and fear conditions in rats. *Behav. Brain Res.* 415, 113515.
- Oswald, M., Tantiigama, M., Sonntag, I., Hughes, S., Empson, R., 2013. Diversity of layer 5 projection neurons in the mouse motor cortex. *Front. Cell. Neurosci.* 7.
- Palminteri, S., et al., 2012. Critical roles for anterior insula and dorsal striatum in punishment-based avoidance learning. *Neuron* 76, 998–1009.
- Palminteri, R.D., 2008. Dopamine signaling in the dorsal striatum is essential for motivated behaviors. *Ann. N. Y. Acad. Sci.* 1129, 35–46.
- Pan, W.X., Mao, T., Dudman, J.T., 2010. Inputs to the dorsal striatum of the mouse reflect the parallel circuit architecture of the forebrain. *Front. Neuroanat.* 4.
- Papp, R.S., Palkovits, M., 2014. Brainstem projections of neurons located in various subdivisions of the dorsolateral hypothalamic area—an anterograde tract-tracing study. *Front. Neuroanat.* (8, 0).
- Parent, M., Wallman, M.-J., Gagnon, D., Parent, A., 2011. Serotonin innervation of basal ganglia in monkeys and humans. *J. Chem. Neuroanat.* 41, 256–265.
- Parent, M.B., Avila, E., McGaugh, J.L., 1995. Footshock facilitates the expression of aversively motivated memory in rats given post-training amygdala basolateral complex lesions. *Brain Res.* 676, 235–244.
- Parolari, L., Schneeberger, M., Heintz, N., Friedman, J.M., 2021. Functional analysis of distinct populations of subthalamic nucleus neurons on Parkinson's disease and OCD-like behaviors in mice. *Mol. Psychiatry* 26, 7029–7046.
- Pasman, E.P., Murnaghan, C.D., Bloem, B.R., Carpenter, M.G., 2011. Balance problems with Parkinson's disease: are they anxiety-dependent? *Neuroscience* 177, 283–291.
- Pasquini, J., et al., 2018. Progression of tremor in early stages of Parkinson's disease: a clinical and neuroimaging study. *Brain* 141, 811–821.
- Peckham, E.L., Hallett, M., 2009. Psychogenic movement disorders. *Neurol. Clin.* 27 (801–vii).
- Peczely, L., Ollmann, T., Laszko, K., Lenard, L., Grace, A.A., 2022. The D2-like dopamine receptor agonist quinpirole microinjected into the ventral pallidum dose-dependently inhibits the VTA and induces place aversion. *Int. J. Neuropsychopharmacol.* 25, 590–599.
- Pei, H., et al., 2019. Lateral hypothalamic Mc3R-expressing neurons modulate locomotor activity, energy expenditure, and adiposity in male mice. *Endocrinology* 160, 343–358.
- Pérez, M.A., et al., 2013. Repeated restraint stress impairs auditory attention and GABAergic synaptic efficacy in the rat auditory cortex. *Neuroscience* 246, 94–107.
- Perju-Dumbrava, L., Kempster, P., 2020. Movement disorders in psychiatric patients. *BMJ Neurol. Open* 2, e000057.
- Pezzulo, G., et al., 2019. The body talks: Sensorimotor communication and its brain and kinematic signatures. *Phys. Life Rev.* 28, 1–21.
- Plummer, N.W., et al., 2020. An intersectional viral-genetic method for fluorescent tracing of axon collaterals reveals details of noradrenergic locus coeruleus structure. *ENEURO.0010-20.2020 eNeuro* 7. ENEURO.0010-20.2020.
- Pohl, A., Anders, S., Schulte-Rüther, M., Mathiak, K., Kircher, T., 2013. Positive facial affect – an fMRI study on the involvement of insula and amygdala. *PLoS One* 8, e69886.
- Proske, U., Gandevia, S.C., 2012. The proprioceptive senses: their roles in signaling body shape, body position and movement, and muscle force. *Physiol. Rev.* 92, 1651–1697.
- Pulvirenti, L., Swerdlow, N.R., Koob, G.F., 1991. Nucleus accumbens NMDA antagonist decreases locomotor activity produced by cocaine, heroin or accumbens dopamine, but not caffeine. *Pharmacol. Biochem. Behav.* 40, 841–845.
- Qiu, F., Zhou, Y., Zhang, L., Zhang, J., Liu, H., 2022. Gender dimorphic M1 excitability during emotional processing: a transcranial magnetic stimulation study. *PeerJ* 10, e13987.



- Qualls-Creekmore, E., et al., 2017. Galanin-expressing GABA neurons in the lateral hypothalamus modulate food reward and noncompulsive locomotion. *J. Neurosci.* 37, 6053–6065.
- Ranjbar, H., Radahmadi, M., Reisi, P., Alaei, H., 2017. Effects of electrical lesion of basolateral amygdala nucleus on rat anxiety-like behaviour under acute, sub-chronic, and chronic stresses. *Clin. Exp. Pharmacol. Physiol.* 44, 470–479.
- Ranson, R.N., Motawei, K., Pyner, S., Coote, J.H., 1998. The paraventricular nucleus of the hypothalamus sends efferents to the spinal cord of the rat that closely appose sympathetic preganglionic neurones projecting to the stellate ganglion. *Exp. Brain Res.* 120, 164–172.
- Reichard, R.A., Parsley, K.P., Subramanian, S., Zahm, D.S., 2019. Dissociable effects of dopamine D1 and D2 receptors on compulsive ingestion and pivoting movements elicited by disinhibiting the ventral pallidum. *Brain Struct. Funct.* 224, 1925–1932.
- Révy, D., et al., 2014. Cellular and behavioral outcomes of dorsal striatonigral neuron ablation: new insights into striatal functions. *Neuropsychopharmacol.* 39, 2662–2672.
- Risold, P.Y. and Swanson, L.W. (1997) Connections of the rat lateral septal complex. 24 (2-3):115-95.
- Rizzi, G., Tan, K.R., 2019. Synergistic nigral output pathways shape movement. *Cell Rep.* 27 (2184–2198), e4.
- Robledo, P., Féger, J., 1990. Excitatory influence of rat subthalamic nucleus to substantia nigra pars reticulata and the pallidum complex: electrophysiological data. *Brain Res.* 518, 47–54.
- Rolls, E.T., Cheng, W., Feng, J., 2020. The orbitofrontal cortex: reward, emotion and depression. *Brain Commun.* 2, fcaa196.
- Roos, R.A., 2010. Huntington's disease: a clinical review. *Orphanet J. Rare Dis.* 5, 40.
- Rozenzweig, B., Portillo-Marquez, G., McGaugh, J.L., 1996. Basolateral amygdala lesions block glucocorticoid-induced modulation of memory for spatial learning. *Behav. Neurosci.* 110, 1074–1083.
- Roseberry, T.K., et al., 2016. Cell-type-specific control of brainstem locomotor circuits by Basal Ganglia. *Cell* 164, 526–537.
- Roseberry, T.K., Lalive, A.L., Margolin, B.D., Kreitzer, A.C., 2019. Locomotor suppression by a monosynaptic amygdala to brainstem circuit. *bioRxiv* 724252. <https://doi.org/10.1101/724252>.
- Rudebeck, P.H., et al., 2008. Frontal cortex subregions play distinct roles in choices between actions and stimuli. *J. Neurosci.* 28, 13775–13785.
- Russell, J.A., 1980. A circumplex model of affect. *J. Personal. Soc. Psychol.* 39, 1161–1178.
- Duclos, S.E., Laird, J.D., Schneider, E., Sexter, M., Stern, L., 2023. Emotion-Specific Effects of Facial Expressions and Postures on Emotional Experience. *J. Pers. Soc. Psychol.* 57 (1), 101–108.
- Saigusa, T., et al., 1995. Dissimilarities between cholinergic and dopaminergic turning elicited by nucleus accumbens stimulation in freely moving rats. *Eur. J. Pharmacol.* 274, 213–220.
- Salamone, J.D., 1994. The involvement of nucleus accumbens dopamine in appetitive and aversive motivation. *Behav. Brain Res.* 61, 117–133.
- Sánchez-Molina, J., Robles-Pérez, J.J., Clemente-Suárez, V.J., 2018. Assessment of psychophysiological response and specific fine motor skills in combat units. *J. Med. Syst.* 42, 67.
- Sanders, S.K., Shekhar, A., 1991. Blockade of GABA<sub>A</sub> receptors in the region of the anterior basolateral amygdala of rats elicits increases in heart rate and blood pressure. *Brain Res.* 567, 101–110.
- Saunders, A., et al., 2015. A direct GABAergic output from the basal ganglia to frontal cortex. *Nature* 521, 85–89.
- Scheggi, S., De Montis, M.G., Gambarana, C., 2018. Making sense of rodent models of anhedonia. *Int. J. Neuropsychopharmacol.* 21, 1049–1065.
- Schiemann, J., et al., 2015. Cellular mechanisms underlying behavioral state-dependent bidirectional modulation of motor cortex output. *Cell Rep.* 11, 1319–1330.
- Schiffino, F.L., et al., 2019. Activation of a lateral hypothalamic-ventral tegmental circuit gates motivation. *PLoS ONE* 14, e0219522.
- Schneider, J.S., Olazabal, U.E., 1984. Behaviorally specific limb use deficits following globus pallidus lesions in rats. *Brain Res.* 308, 341–346.
- Schoenbaum, G., Chiba, A.A., Gallagher, M., 1998. Orbitofrontal cortex and basolateral amygdala encode expected outcomes during learning. *Nat. Neurosci.* 1, 155–159.
- Schor, J.S., et al., 2022. Therapeutic deep brain stimulation disrupts movement-related subthalamic nucleus activity in parkinsonian mice. *eLife* 11, e75253.
- Schulz, D., Canbeyli, R.S., 2000. Lesion of the bed nucleus of the stria terminalis enhances learned despair. *Brain Res. Bull.* 52, 83–87.
- Schwab, R.S., Zieper, L., 1965. Effects of mood, motivation, stress and alertness on the performance in Parkinson's disease. *Psychiatr. Neurol. (Basel)* 150, 345–357.
- Schwabe, L., Wolf, O.T., 2010. Socially evaluated cold pressor stress after instrumental learning favors habits over goal-directed action. *Psychoneuroendocrinology* 35, 977–986.
- Schwabe, L., Wolf, O.T., 2011. Stress-induced modulation of instrumental behavior: From goal-directed to habitual control of action. *Behav. Brain Res.* 219, 321–328.
- Schwartz, A.B., 2016. Movement: how the brain communicates with the world. *Cell* 164, 1122–1135.
- Semba, K., Fibiger, H.C., 1992. Afferent connections of the laterodorsal and the pedunculopontine tegmental nuclei in the rat: a retro- and antero-grade transport and immunohistochemical study. *J. Comp. Neurol.* 323, 387–410.
- Seo, C., et al., 2019. Intense threat switches dorsal raphe serotonin neurons to a paradoxical operational mode. *Science* 363, 538.
- Serradj, N., et al., 2023. Task-specific modulation of corticospinal neuron activity during motor learning in mice. *Nat. Commun.* 14, 2708.
- Sesack, S.R., Deutch, A.Y., Roth, R.H., Bunney, B.S., 1989. Topographical organization of the efferent projections of the medial prefrontal cortex in the rat: an anterograde tract-tracing study with Phaseolus vulgaris leucoagglutinin. *J. Comp. Neurol.* 290, 213–242.
- Shackman, A.J., Maxwell, J.S., McMenamin, B.W., Greischar, L.L., Davidson, R.J., 2011. Stress potentiates early and attenuates late stages of visual processing. *J. Neurosci.* 31, 1156–1161.
- Shafir, T., Tsachor, R.P., Welch, K.B., 2016. Emotion regulation through movement: unique sets of movement characteristics are associated with and enhance basic emotions. *Front. Psychol.* 6.
- Sharp, B.M., 2017. Basolateral amygdala and stress-induced hyperexcitability affect motivated behaviors and addiction. *Transl. Psychiatry* 7, e1194.
- Shi, W., et al., 2022. Whole-brain mapping of efferent projections of the anterior cingulate cortex in adult male mice. *174480692210945 Mol. Pain.* 18, 174480692210945.
- Shiba, M., et al., 2000. Anxiety disorders and depressive disorders preceding Parkinson's disease: a case-control study. *Mov. Disord.* 15, 9.
- Shik, M.L., Severin, F.V., Orlovskii, G.N., 1966. [Control of walking and running by means of electric stimulation of the midbrain]. *Biofizika* 11, 659–666.
- Shipp, S., 2007. Structure and function of the cerebral cortex. *Curr. Biol.* 17, R443–R449.
- Sim, L.J., Joseph, S.A., 1993. Dorsal raphe nucleus efferents: termination in peptidergic fields. *Peptides* 14, 75–83.
- Sirieux, C., Gervasoni, D., Luppi, P.-H., Léger, L., 2012. Role of the lateral paraventricular nucleus in the network of paradoxical (REM) sleep: an electrophysiological and anatomical study in the rat. *PLoS One* 7, e28724.
- Skinner, R.D., Garcia-Rill, E., 1984. The mesencephalic locomotor region (MLR) in the rat. *Brain Res.* 323, 385–389.
- Smith, J.B., et al., 2016. Genetic-based dissection unveils the inputs and outputs of striatal patch and matrix compartments. *Neuron* 91, 1069–1084.
- Smith, L.K., Jadavji, N.M., Colwell, K.L., Katrina Perekhodoff, S., Metz, G.A., 2008. Stress accelerates neural degeneration and exaggerates motor symptoms in a rat model of Parkinson's disease. *Eur. J. Neurosci.* 27, 2133–2146.
- Soares-Cunha, C., et al., 2016. Activation of D2 dopamine receptor-expressing neurons in the nucleus accumbens increases motivation. *Nat. Commun.* 7, 11829.
- Son, S., et al., 2022. Whole-brain wiring diagram of oxytocin system in adult mice. *J. Neurosci.* 42, 5021–5033.
- Speranza, L., di Porzio, U., Viggiano, D., de Donato, A., Volpicelli, F., 2021. Dopamine: the neuromodulator of long-term synaptic plasticity, reward and movement control. *Cells* 10, 735.
- Stanley, A.T., Lippicello, P., Sulzer, D., Miniaci, M.C., 2021. Roles for the dorsal striatum in aversive behavior. *Front. Cell. Neurosci.* (15), 0.
- Stanley, B.G., Urstadt, K.R., Charles, J.R., Kee, T., 2011. Glutamate and GABA in lateral hypothalamic mechanisms controlling food intake. *Physiol. Behav.* 104, 40–46.
- Steingard, T.L., Rye, D.B., Wainer, B.H., 1992. Afferent projections to the cholinergic pedunculopontine tegmental nucleus and adjacent midbrain extrapyramidal area in the albino rat. I. Retrograde tracing studies. *J. Comp. Neurol.* 321, 515–543.
- Stephenson-Jones, M., et al., 2020. Opposing contributions of GABAergic and glutamatergic ventral pallidum neurons to motivational behaviors. *Neuron* 105, 921–933.e5.
- Stuhrmann, A., Suslow, T., Dannlowski, U., 2011. Facial emotion processing in major depression: a systematic review of neuroimaging findings. *Biol. Mood Anxiety Disord.* 1, 10.
- Subramanian, S., et al., 2018. Lateral preoptic and ventral pallidal roles in locomotion and other movements. *Brain Struct. Funct.* 223, 2907–2924.
- Swanson, L.W., Mogenson, G.J., Gerfen, C.R., Robinson, P., 1984. Evidence for a projection from the lateral preoptic area and substantia innominata to the 'mesencephalic locomotor region' in the rat. *Brain Res.* 295, 161–178.
- Sztainberg, Y., Kuperman, Y., Justice, N., Chen, A., 2011. An anxiolytic role for CRF receptor type 1 in the globus pallidus. *J. Neurosci.* 31, 17416–17424.
- Tai, C.-H., 2022. Subthalamic burst firing: a pathophysiological target in Parkinson's disease. *Neurosci. Biobehav. Rev.* 132, 410–419.
- Takagishi, M., Chiba, T., 1991. Efferent projections of the infralimbic (area 25) region of the medial prefrontal cortex in the rat: an anterograde tracer PHA-L study. *Brain Res.* 566, 26–39.
- Tan, E.K., et al., 2005. Non-motor manifestations in essential tremor: use of a validated instrument to evaluate a wide spectrum of symptoms. *Park. Relat. Disord.* 11, 375–380.
- Tanner, C.M., Ostrem, J.L., 2020. Therapeutic advances in movement disorders. *Neurotherapeutics* 17, 1325–1330.
- Teka, W.W., et al., 2017. From the motor cortex to the movement and back again. *PLoS One* 12, e0179288.
- Tempel, A., Zukin, R.S., 1987. Neuroanatomical patterns of the mu, delta, and kappa opioid receptors of rat brain as determined by quantitative in vitro autoradiography. *Proc. Natl. Acad. Sci. U. S. A.* 84, 4308–4312.
- Terra, H., et al., 2020. Prefrontal cortical projection neurons targeting dorsomedial striatum control behavioral inhibition. *Curr. Biol.* 30, 4188–4200.e5.
- Thorpe, A.J., Kotz, C.M., 2005. Orexin A in the nucleus accumbens stimulates feeding and locomotor activity. *Brain Res.* 1050, 156–162.
- Tödt, I., et al., 2022. The contribution of subthalamic nucleus deep brain stimulation to the improvement in motor functions and quality of life. *Mov. Disord.* 37, 291–301.
- Tovote, P., Fadok, J.P., Lüthi, A., 2015. Neuronal circuits for fear and anxiety. *Nat. Rev. Neurosci.* 16, 317–331.
- Turner, K.M., Sveghorn, A., Langguth, M., McKenzie, C., Robbins, T.W., 2022. Opposing roles of the dorsolateral and dorsomedial striatum in the acquisition of skilled action sequencing in rats. *J. Neurosci.* 42, 2039–2051.
- Ugedo, L., De Deurwaerdere, P., 2021. Chapter 10 - Serotonergic control of the glutamatergic neurons of the subthalamic nucleus. In: Di Giovanni, G., De

- Deurwaerdere, P.) (Eds.), in *Progress in Brain Research*, vol. 261. Elsevier, pp. 423–462.
- Usseglio, G., Gatier, E., Heuzé, A., Hérent, C., Bouvier, J., 2020. Control of orienting movements and locomotion by projection-defined subsets of brainstem V2a neurons. *Curr. Biol.* 30 (4665–4681), e6.
- Usuda, I., Tanaka, K., Chiba, T., 1998. Efferent projections of the nucleus accumbens in the rat with special reference to subdivision of the nucleus: biotinylated dextran amine study. *Brain Res.* 797, 73–93.
- Valencia Garcia, S., et al., 2018. Ventromedial medulla inhibitory neuron inactivation induces REM sleep without atonia and REM sleep behavior disorder. *Nat. Commun.* 9, 504.
- Valverde, S., et al., 2020. Deep brain stimulation-guided optogenetic rescue of parkinsonian symptoms. *Nat. Commun.* 11, 2388.
- Van Bockstaele, E.J., Pieribone, V.A., Aston-Jones, G., 1989. Diverse afferents converge on the nucleus paragigantocellularis in the rat ventrolateral medulla: retrograde and anterograde tracing studies. *J. Comp. Neurol.* 290, 561–584.
- van der Zouwen, C.L., et al., 2021. Freely behaving mice can brake and turn during optogenetic stimulation of the mesencephalic locomotor region. *Front. Neural Circuits* 15.
- van Dijk, G., Strubbe, J.H., 2003. Time-dependent effects of neuropeptide Y infusion in the paraventricular hypothalamus on ingestive and associated behaviors in rats. *Physiol. Behav.* 79, 575–580.
- Van Gaalen, M.M., Stenzel-Poore, M.P., Holsboer, F., Steckler, T., 2002. Effects of transgenic overproduction of CRH on anxiety-like behaviour: CRH overexpression and anxiety-like behaviour. *Eur. J. Neurosci.* 15, 2007–2015.
- van Loon, A.M., van den Wildenberg, W.P.M., van Stegeren, A.H., Hajcak, G., Ridderinkhof, K.R., 2010. Emotional stimuli modulate readiness for action: a transcranial magnetic stimulation study. *Cogn. Affect Behav. Neurosci.* 10, 174–181.
- Van Pett, K., et al., 2000. Distribution of mRNAs encoding CRF receptors in brain and pituitary of rat and mouse. *J. Comp. Neurol.* 428, 191–212.
- van Zessen, R., Phillips, J.L., Budygin, E.A., Stuber, G.D., 2012. Activation of VTA GABA neurons disrupts reward consumption. *Neuron* 73, 1184–1194.
- Vandaele, Y., et al., 2023. Distinct recruitment of dorsomedial and dorsolateral striatum erodes with extended training. *eLife* 8, e49536.
- Vento, P.J., Burnham, N.W., Rowley, C.S., Zhou, T.C., 2017. Learning from one's mistakes: a dual role for the rostromedial tegmental nucleus in the encoding and expression of punished reward seeking. *Biol. Psychiatry* 81, 1041–1049.
- Vertes, R.P., 2004. Differential projections of the infralimbic and prelimbic cortex in the rat. *Synapse* 51, 32–58.
- Verty, A.N.A., McGregor, I.S., Mallet, P.E., 2005. Paraventricular hypothalamic CB(1) cannabinoid receptors are involved in the feeding stimulatory effects of Delta(9)-tetrahydrocannabinol. *Neuropharmacology* 49, 1101–1109.
- Vestlund, J., et al., 2019. Ghrelin signalling within the rat nucleus accumbens and skilled reach foraging. *Psychoneuroendocrinology* 106, 183–194.
- Vestlund, J., Jerlhag, E., 2020. Glucagon-like peptide-1 receptors and sexual behaviors in male mice. *Psychoneuroendocrinology* 117, 104687.
- Viden, A., et al., 2022. Organisation of enkephalin inputs and outputs of the central nucleus of the amygdala in mice. *J. Chem. Neuroanat.* 125, 102167.
- Villalobos, C.A., Basso, M.A., 2022. Optogenetic activation of the inhibitory nigro-collicular circuit evokes contralateral orienting movements in mice. *Cell Rep.* 39, 110699.
- Vitrac, C., Benoit-Marand, M., 2017. Monoaminergic modulation of motor cortex function. *Front. Neural Circuits* 11.
- de Vrind, V.A.J., Rozeboom, A., Wolterink-Donselaar, I.G., Luijendijk-Berg, M.C.M., Adan, R.A.H., 2019. Effects of GABA and leptin receptor-expressing neurons in the lateral hypothalamus on feeding, locomotion, and thermogenesis. *Obesity* 27, 1123–1132.
- Wall, N.R., De La Parra, M., Callaway, E.M., Kreitzer, A.C., 2013. Differential innervation of direct- and indirect-pathway striatal projection neurons. *Neuron* 79, 347–360.
- Wallace, D.M., Magnuson, D.J., Gray, T.S., 1992. Organization of amygdaloid projections to brainstem dopaminergic, noradrenergic, and adrenergic cell groups in the rat. *Brain Res. Bull.* 28, 447–454.
- Wallén-Mackenzie, Å., et al., 2020. Spatio-molecular domains identified in the mouse subthalamic nucleus and neighboring glutamatergic and GABAergic brain structures. *Commun. Biol.* 3, 338.
- Wang, H.-L., Morales, M., 2009. Pedunculo-pontine and laterodorsal tegmental nuclei contain distinct populations of cholinergic, glutamatergic and GABAergic neurons in the rat. *Eur. J. Neurosci.* 29, 340–358.
- Wang, J., et al., 2021. Divergent projection patterns revealed by reconstruction of individual neurons in orbitofrontal cortex. *Neurosci. Bull.* 37, 461–477.
- Wang, X.-Y., Zhao, M., Ghitza, U.E., Li, Y.-Q., Lu, L., 2008. Stress impairs reconsolidation of drug memory via glucocorticoid receptors in the basolateral amygdala. *J. Neurosci.* 28, 5602–5610.
- Watabe-Uchida, M., Zhu, L., Ogawa, S.K., Vamanrao, A., Uchida, N., 2012. Whole-brain mapping of direct inputs to midbrain dopamine neurons. *Neuron* 74, 858–873.
- Weisskopf, M.G., Chen, H., Schwarzschild, M.A., Kawachi, I., Ascherio, A., 2003. Prospective study of phobic anxiety and risk of Parkinson's disease. *Mov. Disord.* 18, 646–651.
- Wilson, M., Chattington, M., Marple-Horvat, D.E., 2008. Eye movements drive steering: reduced eye movement distribution impairs steering and driving performance. *J. Mot. Behav.* 40, 190–202.
- Woodworth, H.L., et al., 2017. Lateral hypothalamic neurotensin neurons orchestrate dual weight loss behaviors via distinct mechanisms. *Cell Rep.* 21, 3116–3128.
- Wright, A.K., Tulloch, I.F., Arbutnot, G.W., 1980. Possible links between hypothalamus and substantia nigra in the rat. *Appetite* 1, 43–51.
- Wu, M., Brudzynski, S.M., Mogenson, G.J., 1993. Functional interaction of dopamine and glutamate in the nucleus accumbens in the regulation of locomotion. *Can. J. Physiol. Pharmacol.* 71, 407–413.
- Wu, Q., Yang, X., Zhang, Y., Zhang, L., Feng, L., 2016. Chronic mild stress accelerates the progression of Parkinson's disease in A53T  $\alpha$ -synuclein transgenic mice. *Exp. Neurol.* 285, 61–71.
- Wu, Y., et al., 2020. The anterior insular cortex unilaterally controls feeding in response to aversive visceral stimuli in mice. *Nat. Commun.* 11, 640.
- Xia, F., Kheirbek, M.A., 2020. Circuit-based biomarkers for mood and anxiety disorders. *Trends Neurosci.* 43, 902–915.
- Xia, M., et al., 2022. Connectome gradient dysfunction in major depression and its association with gene expression profiles and treatment outcomes. *Mol. Psychiatry* 27, 1384–1393.
- Xiao, L., Priest, M.F., Nasenbeny, J., Lu, T., Kozorovitskiy, Y., 2017. Biased oxytocinergic modulation of midbrain dopamine systems. *Neuron* 95 (368–384), e5.
- Xie, C., Power, J., Prasad, A.A., 2022. Bidirectional optogenetic modulation of the subthalamic nucleus in a rodent model of parkinson's disease. *Front. Neurosci.* 16.
- Xue, Y. *et al.* Symptomatic responses elicited by electrical stimulation of the cingulate cortex: Study of a cohort of epileptic patients and literature review. *Human Brain Mapping n/a*, (2023).
- Yao, L., et al., 2021. Stress controllability modulates basal activity of dopamine neurons in the substantia nigra compacta. *ENEURO.0044-21.2021 eNeuro* 8. ENEURO.0044-21.2021.
- Yoshie, M., Kudo, K., Ohtsuki, T., 2009. Motor/autonomic stress responses in a competitive piano performance. *Ann. N. Y. Acad. Sci.* 1169, 368–371.
- Yu, K., Garcia da Silva, P., Albeanu, D.F., Li, B., 2016. Central amygdala somatostatin neurons gate passive and active defensive behaviors. *J. Neurosci.* 36, 6488–6496.
- Zahm, D.S., 1999. Functional-anatomical implications of the nucleus accumbens core and shell subterritories. *Ann. NY Acad. Sci.* 877, 113–128.
- Zahm, D.S., et al., 2011. Inputs to the midbrain dopaminergic complex in the rat, with emphasis on extended amygdala-recipient sectors. *J. Comp. Neurol.* 519, 3159–3188.
- Zahm, D.S., Heimer, L., 1993. Specificity in the efferent projections of the nucleus accumbens in the rat: comparison of the rostral pole projection patterns with those of the core and shell. *J. Comp. Neurol.* 327, 220–232.
- Zahm, D.S., Schwartz, Z.M., Lavezzi, H.N., Yetnikoff, L., Parsley, K.P., 2014. Comparison of the locomotor activating effects of bicuculline infusions into the preoptic area and ventral pallidum. *Brain Struct. Funct.* 219, 511–526.
- Zhang, M., et al., 2021. Spatially resolved cell atlas of the mouse primary motor cortex by MERFISH. *Nature* 598, 137–143.
- Zhang, X., et al., 2023. Large-scale brain functional network abnormalities in social anxiety disorder. *Psychol. Med.* 53, 6194–6204.
- Zhao, P., et al., 2020. Long-range input of cortical neurons containing corticotropin-releasing hormone. *Sci. Rep.* 10, 12209.
- Zhu, X., Ottenheimer, D., DiLeone, R.J., 2016. Activity of D1/2 receptor expressing neurons in the nucleus accumbens regulates running, locomotion, and food intake. *Front. Behav. Neurosci.* 10, 66.