



HAL
open science

ECRA Thruster latest development at ONERA: Focus on thrust vectoring activities

Victor Desangles, Federico Boni, Renaud Ferrand, Etienne Gourcerol, Romain Pioch, Paul-Quentin Elias, Denis Packan

► **To cite this version:**

Victor Desangles, Federico Boni, Renaud Ferrand, Etienne Gourcerol, Romain Pioch, et al.. ECRA Thruster latest development at ONERA: Focus on thrust vectoring activities. EUCASS-CEAS 2023, Jul 2023, Lausanne, Switzerland. 10.13009/EUCASS2023-761 . hal-04309858

HAL Id: hal-04309858

<https://hal.science/hal-04309858v1>

Submitted on 27 Nov 2023

HAL is a multi-disciplinary open access archive for the deposit and dissemination of scientific research documents, whether they are published or not. The documents may come from teaching and research institutions in France or abroad, or from public or private research centers.

L'archive ouverte pluridisciplinaire **HAL**, est destinée au dépôt et à la diffusion de documents scientifiques de niveau recherche, publiés ou non, émanant des établissements d'enseignement et de recherche français ou étrangers, des laboratoires publics ou privés.

ECRA Thruster latest development at ONERA: Focus on thrust vectoring activities

Victor DESANGLES[†], Federico BONI, Renaud FERRAND, Etienne GOURCEROL, Romain PIOCH, Paul-Quentin ELIAS, Denis PACKAN

DPHY, ONERA, Université Paris-Saclay, F-91123 Palaiseau, France

[†] Corresponding Author: victor.desangles@onera.fr

Abstract

ECRA thruster is a new technology of electric propulsion based on a microwave plasma accelerated in a magnetic nozzle. It represents a promising alternative to heritage technologies as it does not need a neutraliser. This brings design simplifications, cost reductions and increased compactness of the system as well as compatibility to alternative propellants. This paper reports the last research activities led at ONERA, which aim at increasing knowledge on this technology. The paper especially focuses on a thrust vectoring device using the magnetic nozzle steering. First results demonstrate an effective thrust vectoring of several degrees.

1. Introduction

ECRA thruster is an electric propulsion device developed at ONERA since 2010 [1]. The thruster is composed of a magnetic nozzle and a microwave plasma source at 2.45 GHz to ionize the propellant gas. So far, it was tested and characterized using Xenon but is *a priori* compatible with any propellant gas. The thruster self generates an axial electric field thanks to the mobility difference of the electrons population to the ion population. This electric field is responsible for the ion acceleration and thrust production. This mechanism of acceleration implies that the plasma flux is naturally neutral and the thruster does not need a neutralizer, contrary to most of electric propulsion devices. The potential of this technology was fully demonstrated during the H2020 MINOTOR project from 2017 to 2020 with a jump in demonstrated total thrust efficiency from about 20 percent to about 45 percent. Performances as high as a specific impulse above 2000 sec and a thrust to power ratio above 60 mN/kW were reached. Two prototypes were developed during this project: a 30W and a 200W version with high and similar performances [2]. Since that, ONERA activities focus on the increase of the understanding of the thruster's operation mechanism. This include works on the dynamic of the ion and electron population inside the magnetic nozzle of the thruster, to develop new way of measuring its thrust, to better explain the thrust production mechanisms and to give inside on magnetic nozzle design for future prototype developments. These researches also target the optimisation of the coupling of the microwave to the plasma in order to go towards an integrated PPU – thruster solution ready to flight. New developments on the thruster are also targeted, as the possibility to use a thrust vectoring system without any movable pieces, based only on the steering of the magnetic nozzle. This paper exposes these different activities and focuses on the first measurements of magnetic thrust vectoring.

2. Overview of current research activities on ECRA

Electron energy anisotropy. In order to understand better the mechanisms at play in the thrust production by ECRA and magnetic nozzle thrusters, it is necessary to improve the description of the electron energy. Two main question are of in interest in this problem, the cooling of electrons along the magnetic nozzle and the initial anisotropy of the electron population [3, 4]. We have dedicated a specific study to this second question. Using thrust measurements made with the thrust stand previously developed in the team and adapted to support either the plasma source or the thruster's magnetic field source, it has been possible to obtain separately the two main contributions to the thrust. The first one is the thermal thrust corresponding to the expansion of the hot plasma outside the source. This pressure term is proportional to the energy of the electrons parallel to the magnetic field and quasi parallel to the thruster's main axis inside the source. The second is the so-called magnetic thrust, associated with the diamagnetic currents in the plasma. It is correlated to the energy of the electrons perpendicular to the applied magnetic field. The differentiated measurement of these two thrust terms has made it possible to highlight the evolution of their ratio. These measurements demonstrate that the thruster's efficiency is maximum when the magnetic thrust dominates for the tested

regimes of the ECRA thruster [5]. Thanks to complementary measurements of electron density in the thruster plume, the ratio of the contributions of these two thrust terms can be used to obtain an anisotropy ratio of the mean electron temperature in the thruster source. This anisotropy can be very large, up to a factor of 5 for the best ECRA operating points. Further work on this topic will be first to measure directly the electron energy anisotropy and second to compare these results with PIC code simulations.

Indirect thrust measurements methodology. The usage of traditional thrust stand, as a way of producing a calibrated measurement of the thrust produced by an electric propulsion thruster, is not always possible for different reasons. First, a lab does not necessarily possess such a device and second, the usage of coils necessitating a strong electric current or the implementation of a cooling fluid on the thruster device can be difficult to implement on a thrust stand. An indirect estimation of the thrust can be done by measuring the ion flux and the ion energy. Previous work on the comparison between direct and indirect thrust measurement, using a Guard ring Faraday Probe, has shown that the indirect measurement method lead to accurate measurement in the case of a low power Hall effect thruster whereas the discrepancy can be as high as 20 % in the case of ECRA. In order to improve the accuracy of the indirect method, a new probe has been developed. This probe has a design close to a deep Faraday Cup, with the particularity of being able to apply angular filtering to the population of ions collected. The probe has a collector divided into a cylindrical body and a washer at the bottom of the probe. If both collectors are used simultaneously to collect the ion flux, the entire ion flux is measured, as in a conventional Faraday cup. If only the collector at the bottom of the probe is used, the probe applies an angular filtering and only ions with a trajectory almost parallel to the probe axis are measured. This probe, mounted on a stage that rotates around its axis (a stage also developed in 2022), adds a degree of freedom to the measurement of ion current density. Using this probe, one can avoid the uncontrolled expansion of the plasma sheath that is leading to overestimation of the ion flux in the case of the guard ring Faraday probe and take into account the local direction of the ion flux in the thrust estimation. Using this method the discrepancy between the direct and indirect thrust measurement can be reduced to 5% in the case of ECRA.

Estimation of the thruster load impedance. The coupling rate of the micro-wave in the plasma is determined by the impedance jump that occurs at the interface between the coaxial line bringing power to the thruster and the thruster source. The total impedance of the thruster source is defined both by the thruster geometry and by the plasma density field. Therefore, the coupling vary between the 30W and the 200W thruster and between the operation points of the thruster. Previous results have shown that the coupling rate varies from 90 to 99 % in the case of the 30W thruster and between 78 and 89 % in the case of the 200W thruster. We anticipate that this rate may keep decreasing as the thruster power and size increases. Therefore, an effort is currently made to measure the complex impedance of the thruster source in order to develop an impedance matching design of the thruster source.

3. Focus on the magnetic nozzle based thrust vectoring research activity

The alignment of the thrust vector is an important parameter of a propulsion engine while on orbit. The ability to change the thrust vector direction is useful to compensate a modification of the position of the centre of mass of a satellite or to increase the manoeuvrability of the satellite. On large satellite platforms, this function is undertaken by mechanical gimbals that carry the thruster and its sub-equipment. On small platform, the usage of such solution is not well suited due to the size and mass of such gimbals systems. In the case of magnetic nozzle thruster, another way of performing an adjustment of the thrust direction is to steer the thrust vector by modifying the magnetic field topology in the nozzle. This section presents the primary results obtained to do so and introduces the next set of experiments that will be led on the topic.

Experimental setup. The experiments are led on the B09 vacuum vessel using the 30W ECR plasma thruster, operated at 1 sccm of Xenon and 24 W of deposited micro-wave power. The thruster is always switched on at least one hour before starting the measurements to try to access to a reproducible and stationary regime.

The ion current density is measured using a Faraday probe. The probe is mounted at 22 cm from the thruster back plate on a rotating arm which rotates in the plane where the thrust vectoring occurs. Its rotation axis is tangent to the back plate of the thruster (Figure 1). The Faraday probe has an internal collector which is biased at -300 V and an outer collector which is left floating. The inner collector is directly exposed to the plasma, not equipped with a screening grid, to avoid the uncertainties associated with the grids transparency. The ion current density, the outer collector floating potential and the thruster potential are acquired during 0.5 sec at 700 Hz for about 150 unevenly spaced angular positions between +70 and -70 degrees to produce angular profiles of these figures.

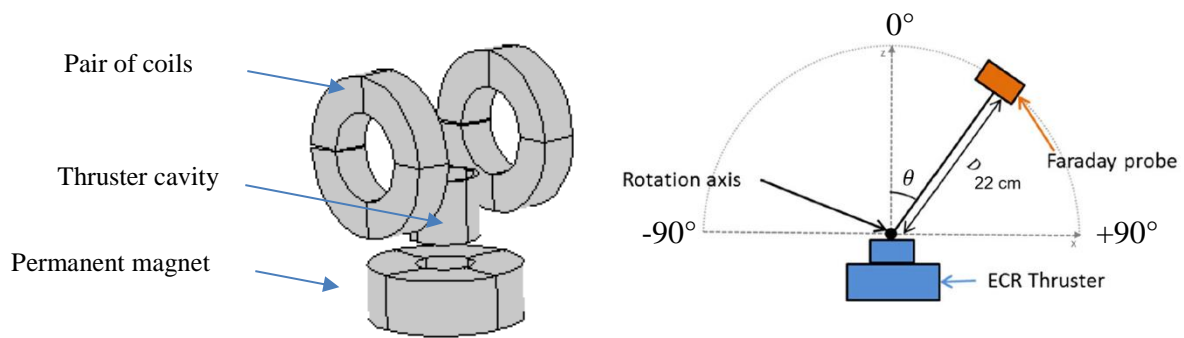

Figure 1: left. 3D modelling of the thruster and its coils in the software COMSOL, Right. Schematic drawing of the measurement setup.

A pair of two coils are placed around the thruster cavity and mounted on a translation axis. This allows changing the axial position of the center of the coils that is set to +30 mm with respect to the back plate at the beginning of this study. It generates a magnetic field perpendicular to the thrust direction. This field add to the magnetic nozzle field generated by the permanent magnet. The two coils have an internal radius of 20 mm, an external radius of 30.4 mm and are 17 mm thick. They are made of 11 turns of a 4 mm^2 copper wire. The distance between the centres of the two coils is 38.5 mm. The coils are fed using a 5 kW DC power supply in Helmholtz like configuration. The coils geometry is modelled using the software COMSOL in order to compute the generated magnetic field. The computed magnetic field map is compared to measurements made using a gauss meter (Figure 2) with good agreement.

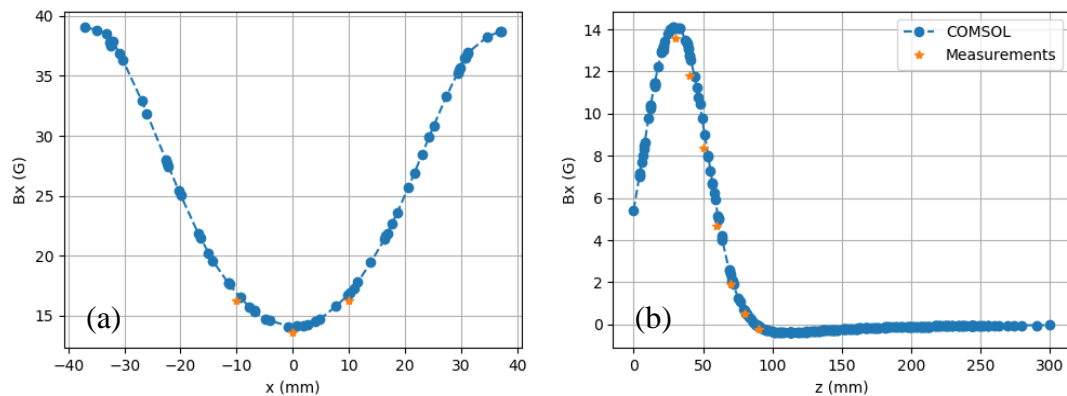

Figure 2: component along x of the magnetic field generated by the coils. Data from COMSOL modelling and measurements are represented. (a) Variation along x on the coils main axis. (b) Variation along z on the main axis of the thruster.

Figure 3 compares the magnetic field generated by the permanent magnet and by the coils. In the centre of the coils, the field generated by the permanent magnet is typically one order of magnitude stronger than the field generated by the coils. Indeed, the magnetic field produce by the coils is about 10 G when the magnetic field of the nozzle is equal to hundreds of gauss at this position. The magnetic field produced by the set of coils at this position will be used to refer to the state of the coils. The power consumption of the set of coils to produce a 14 gauss field on the thruster's main axis is 5 W.

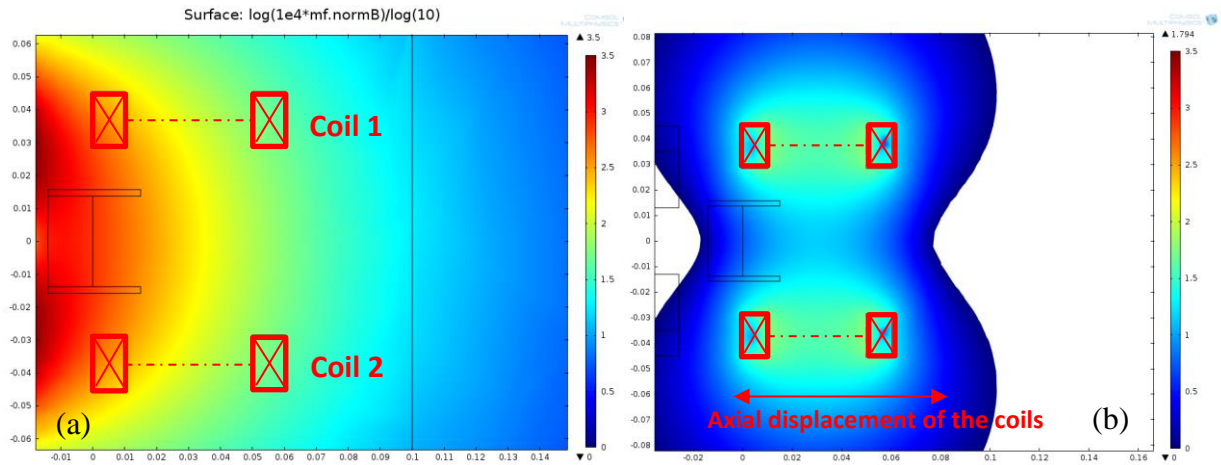

Figure 3: Norm of the magnetic field generated, (a) by the permanent magnet, (b) by the pair of coils for a 5.5 watts feeding

Optically observed effect. A camera is mounted on the side of the experiment and allow taking pictures of the plume of the thruster. The coils are fed with different values of current from 0 amps to 21 amps corresponding to an input power of 0 and 8.5 W. The effect of the applied perpendicular magnetic field is difficult to observe in the stationary regime and in standards conditions of operation (Figure 4). However, an effect can be clearly identified if one increases the flow rate to several sccm or during the start-up of the thruster (Figure 5). The deviation angle that is observed in these cases is measured on the image and reported on Figure 5.

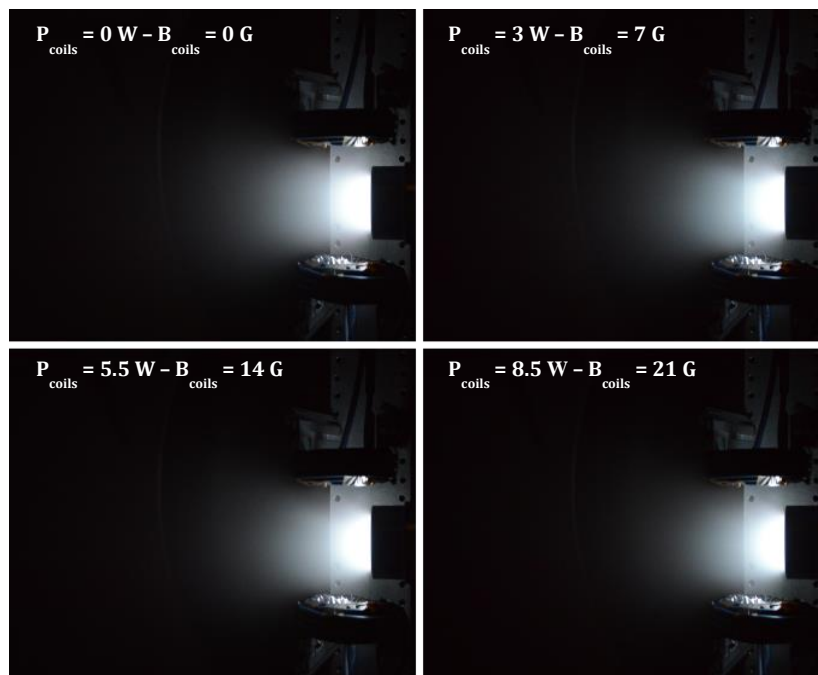

Figure 4: Pictures of the plume of the thruster for different values of perpendicular magnetic field during the stationary regime and for standard conditions of operation

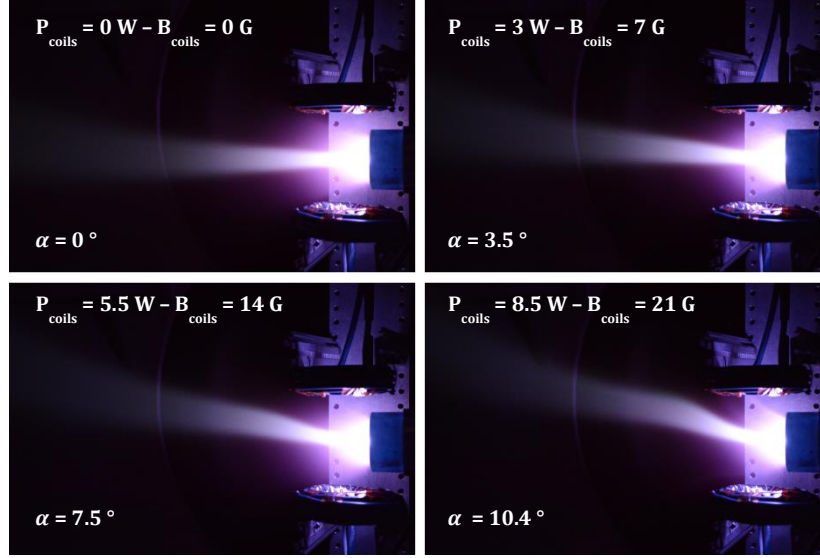

Figure 5: Pictures of the plume of the thruster for different values of perpendicular magnetic field during the startup regime and for standard conditions of operation

Results: ion flux deflection angle. Without the externally applied perpendicular magnetic field by the coils, the ion current density angular distribution is close to be symmetric around the axis of symmetry of the thruster (figure 6a). When a perpendicular magnetic field is applied, the ion current density angular distribution is modified. The central current density peak amplitude reduces and the shape of the profile is di-symmetrized (figure 6a). To quantify these effects, one can integrate the measured ion current density along the azimuthal axis θ , quoted I_I and compute the position of the ion current density barycenter quoted θ_{BJ} .

$$I_I = R * \int J_I(\theta) D\theta \quad (1)$$

with R the length of the rotating arm, and $J_I(\theta)$ the local ion current density.

$$\theta_{BJ} = \frac{\int J_I(\theta) * \theta * D\theta}{\int J_I D\theta} \quad (2)$$

These two quantities are computed for a set of values including the three ion current density profiles presented Figure 6a. The barycentre of the ion current density profile of almost +/- 1 degree with the applied perpendicular magnetic field, from -28 to +28 gauss (Figure 6b). As observed on Figure 6a, the amplitude of the ion current density decreases when increasing the perpendicular magnetic field. This is confirmed by the evolution of I_I with the applied field, which show a decrease by 40% (Figure 6c).

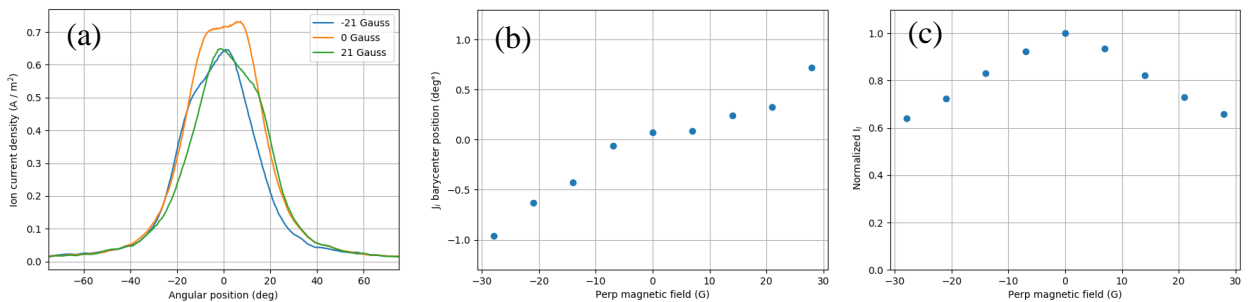

Figure 6: (a) measured ion current density using a Faraday probe for three different perpendicular magnetic fields: -21, 0 and 21 gauss. (b) Current density angular profile barycenter, (c) normalized ion current density profiles integrated along the poloidal angle, for different perpendicular magnetic field.

Results: thrust deflection angle. The previous section showed that adding a perpendicular magnetic field to the magnetic nozzle distorts the ion current density profile. Using these measurements and some hypothesis on the ion flux properties, one can try to estimate the deflection angle of the produce thrust. The computations will be made in spherical coordinates, with θ the polar angle and φ the azimuthal angle.

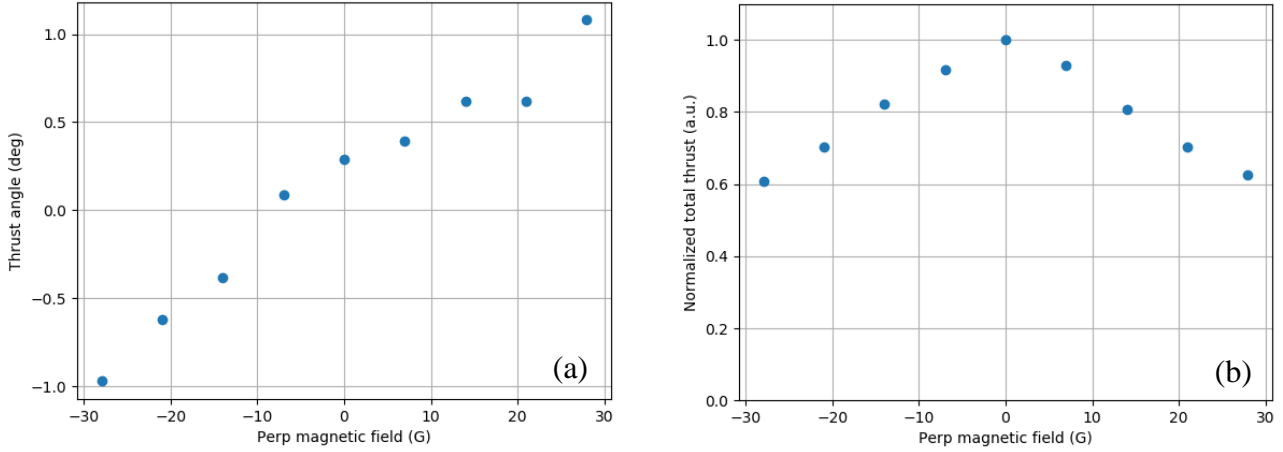

Figure 7: (a) measured thrust angle, (b) normalized thrust amplitude, against the perpendicular applied magnetic field.

By making the hypothesis that the ion current density has a symmetry of rotation around the thruster axis when the perpendicular coils are not used, one can compute the total emitted ion current I as the result of the integration of $J_i(\theta)$ both azimuthally and poloidally at constant radius.

$$I = \iint J_i(\theta, \phi) R^2 \sin(\theta) d\theta d\phi \quad (3)$$

Let's now T be the value of the thrust along the axis of symmetry of the ion current flux angular distribution and $v_i(\theta)$ the average ion velocity in the direction θ . Hypothesis is here made that v_i is independent of θ . This hypothesis is supported by previous work by Vialis [6]. From the previous equation, T can be computed as:

$$T = \iint v_i \cos(\theta) * J_i(\theta, \phi) R^2 \sin(\theta) d\theta d\phi \quad (4)$$

Using this equation is impossible when the symmetry of the ion current density profile is broken as in our case when the perpendicular coils are used. In order to estimate the thrust angle and the thrust level from our measurements, the hypothesis is made the ion current density keeps its axial symmetry, or is only marginally asymmetric, around a tilted axis escaping the thruster with an angle θ_0 in the measurement plane. We define $T_{\parallel}(\theta_0)$ the thrust parallel to the direction θ_0 and $T_{\perp}(\theta_0)$ the thrust perpendicular to the direction θ_0 and pointing towards the positive values of θ .

$$T_{\parallel}(\theta_0) = \iint v_i \cos(\theta) * J_i(\theta - \theta_0) R^2 \sin(\theta) d\theta d\phi \quad (5)$$

$$T_{\perp}(\theta_0) = \iint v_i \sin(\theta) * \cos(\phi) * J_i(\theta - \theta_0) R^2 \sin(\theta) d\theta d\phi \quad (6)$$

$T_{\parallel}(\theta_0)$ and $T_{\perp}(\theta_0)$ are computed for a range of values of θ_0 to assess the minimum of $|T_{\perp}(\theta_0)|$. This minimum corresponds to the estimation axis of symmetry of the deflected ion current density profile and of the thrust angle. $T_{\parallel}(\theta_0)$ corresponds to the thrust amplitude within the limit of all the above-mentioned hypothesis. Using this method, one can estimate the thrust vectoring efficiency by the deflection angle obtained and the corresponding level of thrust (Figure 7a) for the different values of the perpendicular B field.

The thrust angle and the amplitude of the thrust are varying quite similarly to the position of the barycenter of the ion current density profile and amplitude of the integrated current. The thrust angle reaches ± 1 degree for ± 28 gauss of perpendicular magnetic field and the thrust amplitude can fall down to 60% of its maximum.

Electron beam deflection. The floating potential profile angular scan, measured by the floating outer collector of the Faraday probe, shows two strong minima at plus and minus 10 degrees (Figure 8a). They correspond to the position of an electron beam that is emitted symmetrically around the central conductor of the thruster. The change in position of the centre of these two minima can be used to estimate the deflection angle of this electron beam while a perpendicular

field is applied. The measurement of this deflection angle is reported on Figure 8b for different values of applied perpendicular field. This angle goes from -10 to $+10$ when the applied field varies from -21 to $+21$ G. By measuring the deflection angle of the central magnetic field line at 22 cm obtained by computation, one can notice it is similar to the electron beam deflection and to the deflection angles measured at thruster start-up on pictures shown Figure 4 (Figure 8b). It appears that these three series of deflection angles are much higher than the one of the ion current and of the thrust, indicating that at least part of the electron population can be much affected by the applied deflection magnetic field.

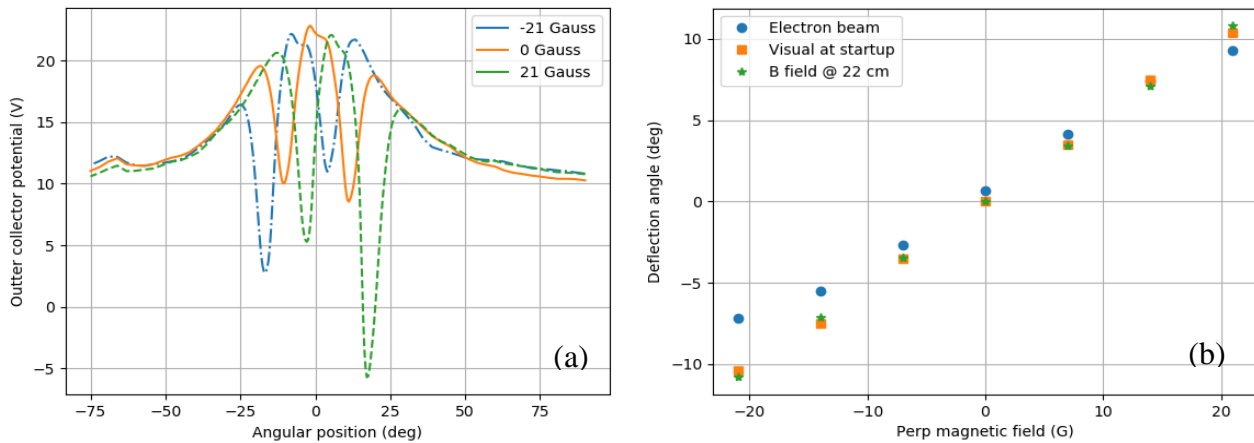

Figure 8: (a) Angular profile of the floating potential of the Faraday probe outer collector for three different fields: -21 , 0 , and $+21$ gauss. (b) Deflection angle of the electron beam against the applied B field.

Effect of the axial position of the coils. The coils assembly is mounted on an axial translation stage. Its position has been kept constant in the previously exposed results and equal to $+30$ mm with respect to the back plate. In this section the effect of the axial position of the coils on the deflection of the ion current density profile, on the thrust vectoring and on the deflection of the electron beam is studied. This axial position is spanned between $+10$ mm and $+45$ mm to the back plate, then between -20 mm to $+15$ mm with respect to the initial position. At each position, two measurements are made, one without a perpendicular magnetic field (0 G) and one with a -14 G coil field.

The ion current density profile barycentre deflection appears to strongly depend upon the axial position of the coils with a higher deflection as set of coils is brought closer to the permanent magnet (ie. for negative values of Z). The 0.6 degree angle measured at the original position goes down to 0.8 degree at -10 mm. The deflection angle seems to saturate to 0.8 degree for position lower than -10 mm (Figure 9a). This result is reproduced for the thrust angle (Figure 9c) with an increase of the thrust deflection angle from -0.8 degree at 0 mm to -1.2 degrees at -17.5 mm. Interestingly, the effect is opposite on the electron beam deflection angle. The angle reduces from -6 degrees at 0 mm to -3.5 degrees at -20 mm (Figure 9b). No saturation of the effect is observed for the lowest values for the coils position. Finally, the thrust amplitude is plotted on figure 8d, compared to the parallel thrust when no perpendicular B field is applied. The thrust ratio is close to 1 for positions below -10 mm and then decreases to reach 0.83 at the reference position and 0.72 at $+15$ mm. All these measurements seem to show that the position of the coils is the best below -10 mm from the reference position. It increases the vectoring efficiency and mitigates the reduction of the thrust amplitude when the perpendicular magnetic field is applied.

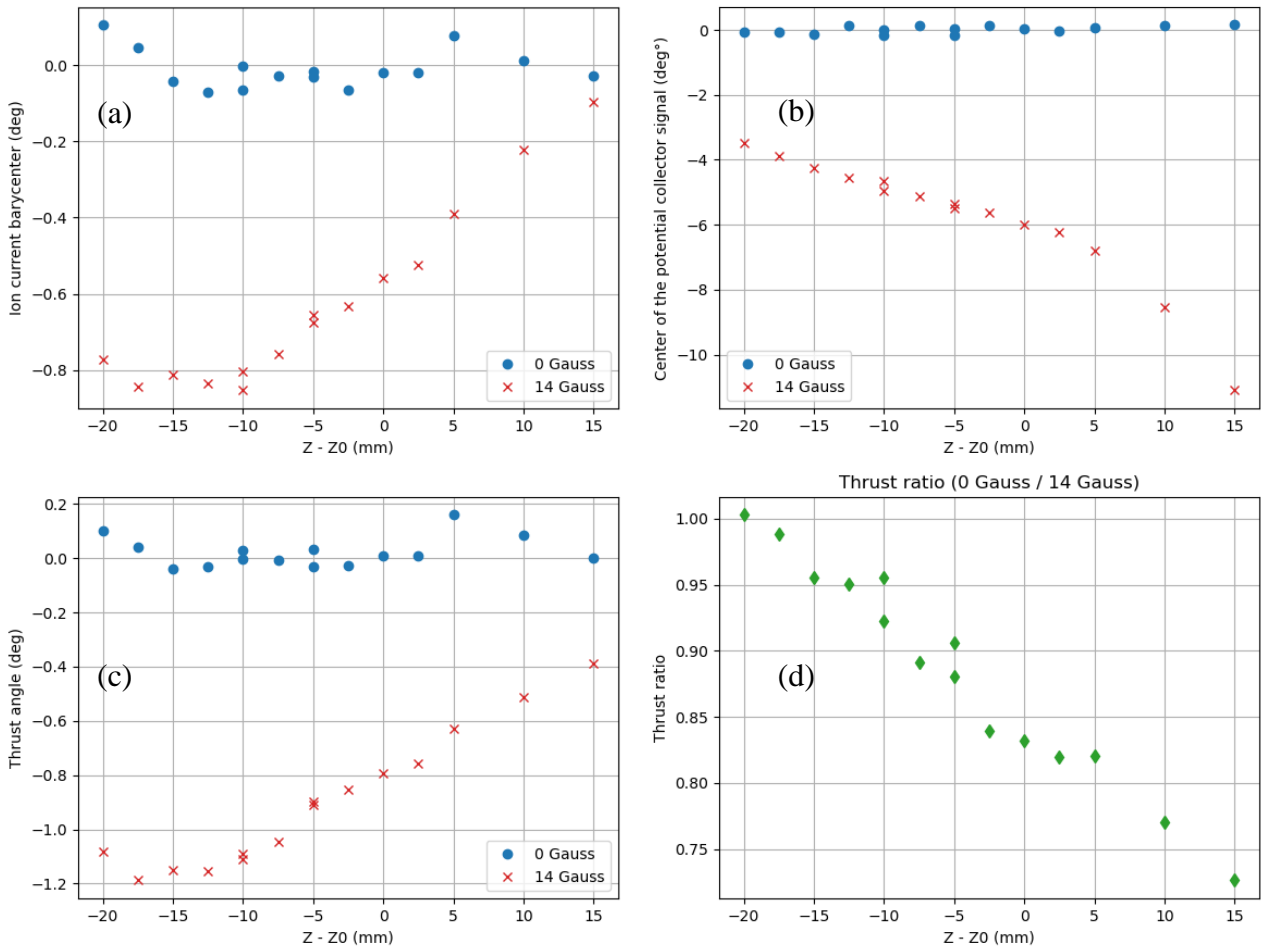

Figure 9: (a) Ion current density barycenter, (b) electron beam deflection angle, (c) thrust angle and (d) ratio of the thrust at 14 G and 0 G, against the axial position of the thrust.

Figure 10a and 10b compare the deflection angles and the normalized thrust amplitudes obtained for different perpendicular magnetic fields and at two coils' positions: 0 mm and -12.5 mm. The magnetic thrust vectoring is more efficient at -12.5 mm than at 0 mm and reaches 3 degrees for 28 G applied. In the meantime, the reduction of thrust amplitude is smaller at -12.5 mm with a decrease of only 20 % for a 28 gauss field instead of 40 % when the coils are at 0 mm.

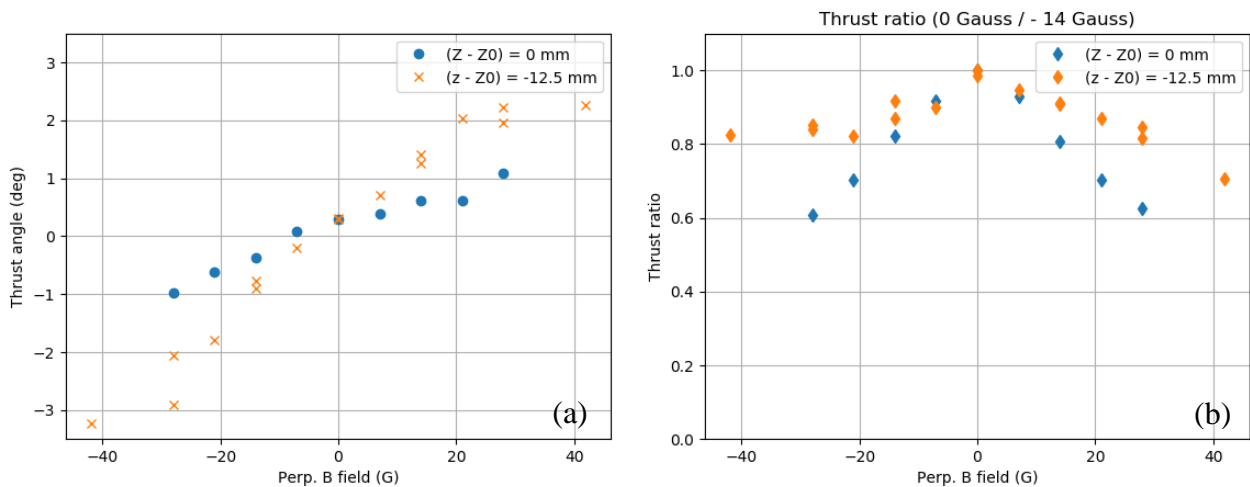

Figure 10: (a) thrust angle, (b) normalized thrust amplitude, against the applied perpendicular magnetic field and for two different axial position of the coils: 0 mm and -12.5 mm.

Conclusion and future work. The present shows how the steering of the thrust vector of the ECR thruster can be estimated using a single ion flux probe measurement mounted on a rotating arm. The measurements have demonstrated the efficiency of a set of two coils placed at the exit of the ECR thruster and producing a magnetic field perpendicular to the thruster axis to steer the thrust vector. The reached deflection efficiency is about 1/6 degree per watt, with a maximum measured deflection angle of 3 degrees. Present work also shows that the axial position of the coils has a strong effect on the vectoring efficiency, with an increase of a factor two of the deflection angle for the same power consumption between the initially tested position and the optimized position in this work. This optimized position found in this work corresponds to the coil centre being 20 mm away from the back plate. Bringing the coils closer to the back plate

Discussion. The present results are an estimation of the ion flux deflection angle and of the magnetic steering of the thrust vector. It relies on unverified hypothesis, such as the conservation of the ion energy when the thrust vectoring system is operated, and on approximation in the integration over θ which formula suppose the symmetry of the ion flux angular distribution around the thrust vector direction. The observed difference between the deflection angle of the ion current density and the electron beam is important and the evolutions of these angles with the axial position of the coils are opposite. For the coils being at 30 mm from the back plate, the electron beam deflection seems to be strictly following the deflection of the computed magnetic field. It indicates that the electrons are still tied to the magnetic nozzle at 22 cm from the back plate. On the contrary, the ions seems to be de-magnetized already 20 mm away from the thruster as the efficiency of the thrust vectoring system starts to decrease. This leads to consider different strategy for the magnetic steering of the thrust vector of magnetic nozzle thruster either playing on the ion trajectory with a strong magnetic field in the source or the electron trajectory using a weaker magnetic field further away in the plume.

Future work. Future work on this topic will aim at reducing the measurement uncertainty by measuring directly the thrust vector angle using for example a two or three axis thrust stand or a arc of probe while a thrust vectoring device is operated. Different geometry of thrust vectoring systems, aiming at distorting the magnetic nozzle at different location in the thruster source or in the thruster plume may be designed to investigate the effect of an ion flux vectoring device and of an electron flux vectoring device. Finally, using lighter gases like krypton or argon would be very interesting, as these ions should stay magnetized further away from the thruster. One can then anticipate that the thrust vectoring will be more efficient, with higher deflection angles. That will also produce some interesting data to better understand the detachment of plasma charges from the magnetic nozzle.

References

- [1] Larigaldie, S., Plasma thruster and method for generating a plasma propulsion thrust, PCT/FR2012/052983, Dec, 2012.
- [2] Désangles, V., Packan, D., Jarrige, J. et al., *ECRA thruster advances: 30W and 200W prototypes latest performances*, Journal of Electric Propulsion **2**, 10 (2023) <https://doi.org/10.1007/s44205-023-00046-x>
- [3] Kim, J.Y., Chung, K.-J., Takahashi, K., et al., *Kinetic electron cooling in magnetic nozzle: Experiments and modelling*, Plasma Sources Science and Technology, Accepted manuscript (2023) <https://doi.org/10.1088/1361-6595/acd71c>
- [4] Porto, J., Elias, P.Q., Ciardi, A., *Anisotropic electron heating in an electron cyclotron resonance thruster with magnetic nozzle*, Physics of Plasmas **30**, 023506 (2023) <https://doi.org/10.1063/5.0124834>
- [5] Boni, F., Desangles, V., Jarrige, J., *Experimental characterization of thrust production mechanisms in a magnetic nozzle ECR thruster*, Journal of Electric Propulsion **1**, 33 (2022) <https://doi.org/10.1007/s44205-022-00034-7>
- [6] T. Vialis, *Développement d'un propulseur plasma à résonance cyclotron électronique pour les satellites*, Ph. D. Dissertation, Sorbonne Université, 2018.