



HAL
open science

Ions 88Sr^+ piégés et refroidis dans un potentiel à symétrie cylindrique dans des pièges annulaires micro-fabriqués

Lilay Gros Desormeaux, Théo Henner, Jean-Pierre Likforman, Luca Guidoni, Peng Zhao, Yu Dian Lim, Chuan Seng Tan, Hongyu Li

► To cite this version:

Lilay Gros Desormeaux, Théo Henner, Jean-Pierre Likforman, Luca Guidoni, Peng Zhao, et al.. Ions 88Sr^+ piégés et refroidis dans un potentiel à symétrie cylindrique dans des pièges annulaires micro-fabriqués. Congrès général des 150 ans de la Société Française de Physique (SFP 2023), Jul 2023, Paris, France. . hal-04308030

HAL Id: hal-04308030

<https://hal.science/hal-04308030>

Submitted on 26 Nov 2023

HAL is a multi-disciplinary open access archive for the deposit and dissemination of scientific research documents, whether they are published or not. The documents may come from teaching and research institutions in France or abroad, or from public or private research centers.

L'archive ouverte pluridisciplinaire **HAL**, est destinée au dépôt et à la diffusion de documents scientifiques de niveau recherche, publiés ou non, émanant des établissements d'enseignement et de recherche français ou étrangers, des laboratoires publics ou privés.

Copyright

Ions 88Sr+ piégés et refroidis dans un potentiel à symétrie cylindrique dans des pièges annulaires micro-fabriqués

L. Gros Désormeaux, T. Henner, J.-P. Likforman, L. Guidoni

Laboratoire Matériaux et Phénomènes Quantiques, Université Paris-Cité / CNRS, F-75013 Paris, France

P. Zhao, Y. D. Lim, C. S. Tan

Nanyang Technological University, Singapore 639798

H.Y. Li

Institute of Microelectronics, Agency for Science, Technology and Research (A*STAR), Singapore 117685

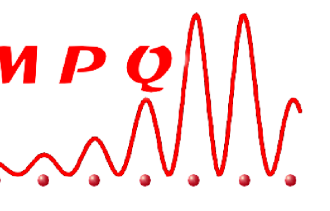

motivation

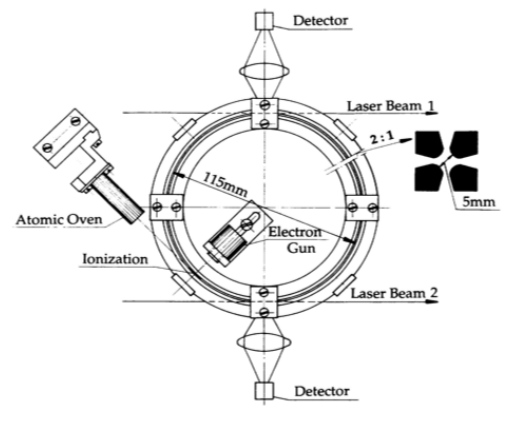

1992 anneaux de stockage macroscopiques : diamètre d'une dizaine de centimètres
refroidissement Doppler tangentiel 1000 ions $^{24}\text{Mg}^+$
refroidissement Sympipe
I. Waki et al., Phys. Rev. Lett. 68, 2007 (1992)

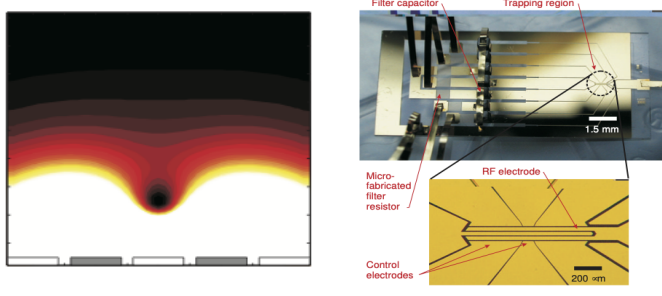

2005 invention piège surfacique linéaire : tailles de quelques dizaines de microns
mise à l'échelle et microfabrication
refroidissement Doppler et bandes laterales
J. Chiaverini et al., Quant. Inf. and Comput. 6, 419 (2005)

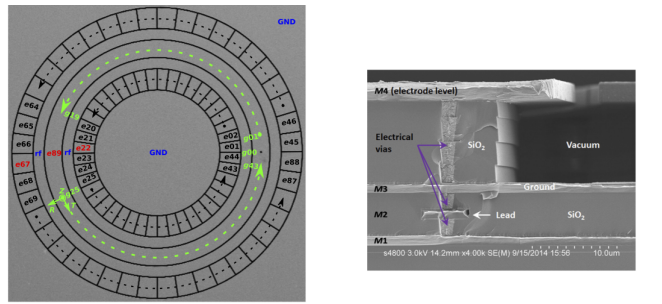

2015 premier piège surfacique annulaire : $R = 624\mu\text{m}$; $H = 83\mu\text{m}$; 400 ions $^{40}\text{Ca}^+$
compensation problématique
microfabrication "multicouche"
B. Tabakov et al., Phys. Rev. Applied 4, 031001 (2015)

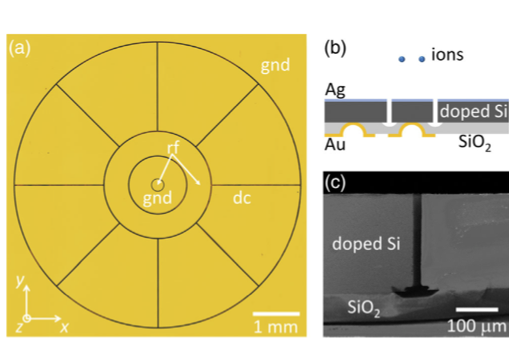

2017/2019 deuxième piège surfacique annulaire : $R = 58\mu\text{m}$; $H = 385\mu\text{m}$; ~20 ions $^{40}\text{Ca}^+$
compensation estimée à 2mK
microfabrication "multicouche"
contrôle du moment cinétique (point trap)
H.-K. Li et al., Phys. Rev. Lett. 118, 153001 (2017)
E. Urban et al., Phys. Rev. Lett. 123, 133202 (2019)

candidats pour "large scale computing" et quantum registers

candidats pour simulation quantique : Kibble-Zurek, radiation de Hawking, Aharanov-Bohm...

dessin et fabrication

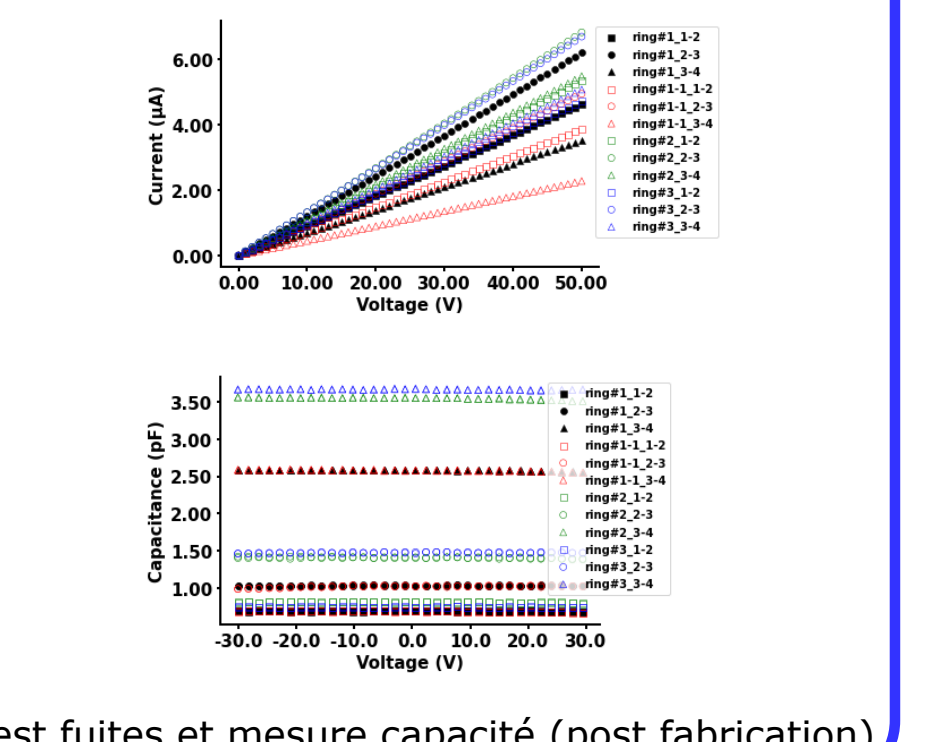
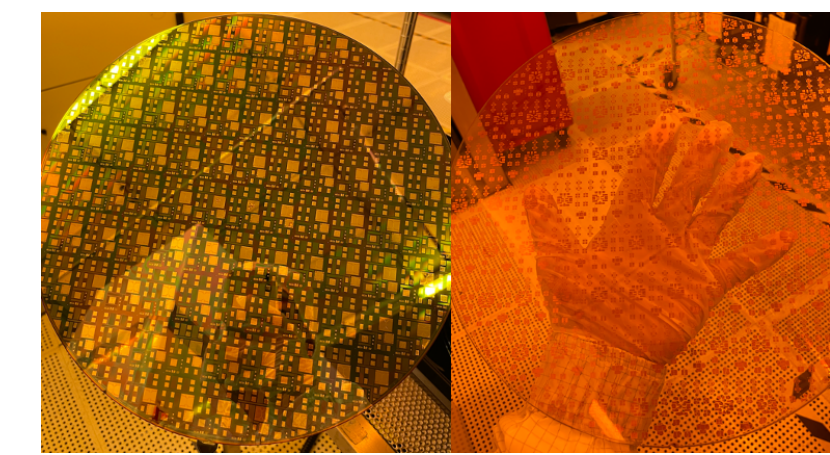
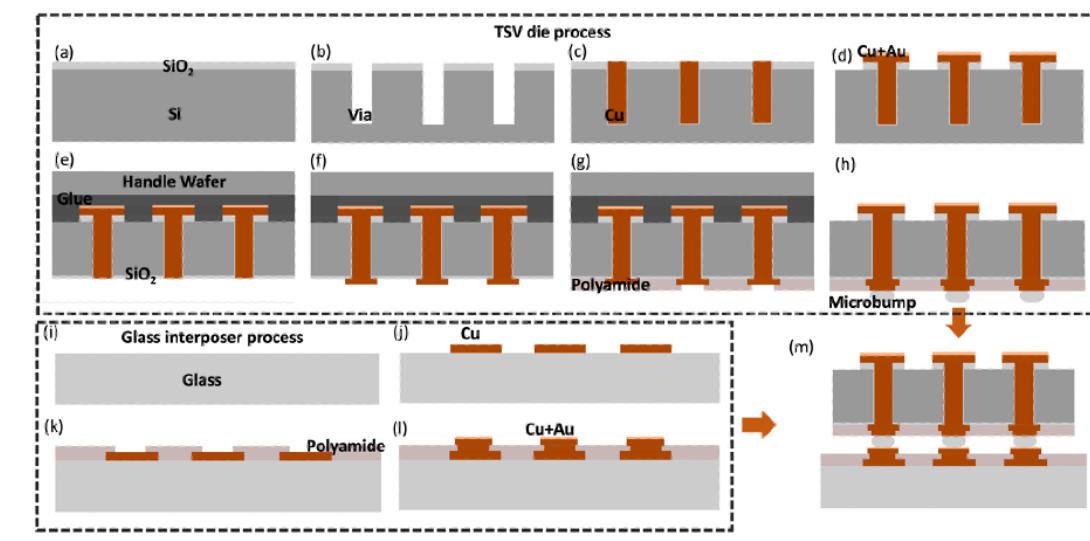
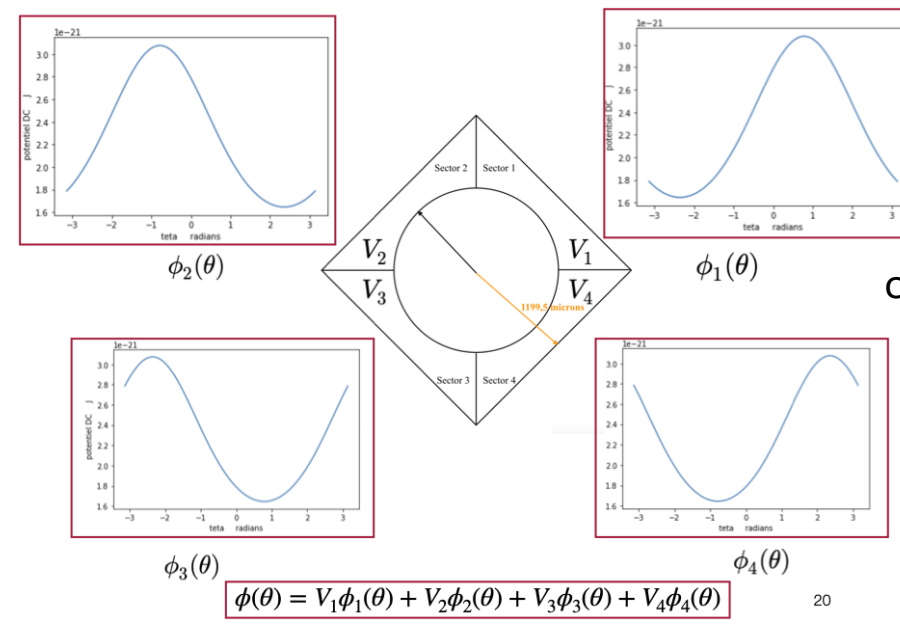
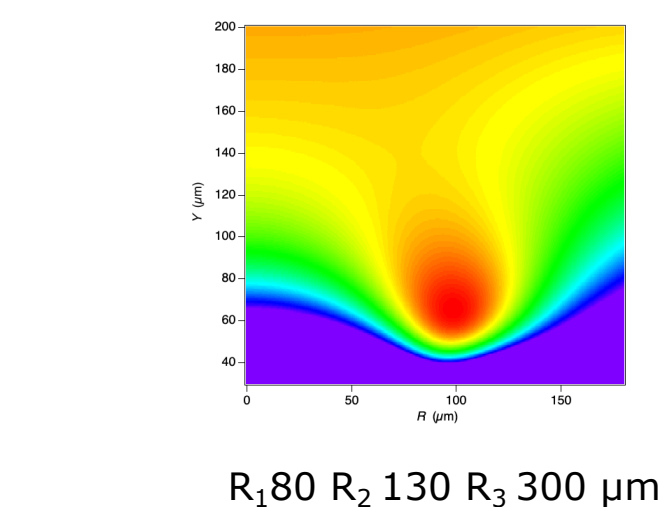
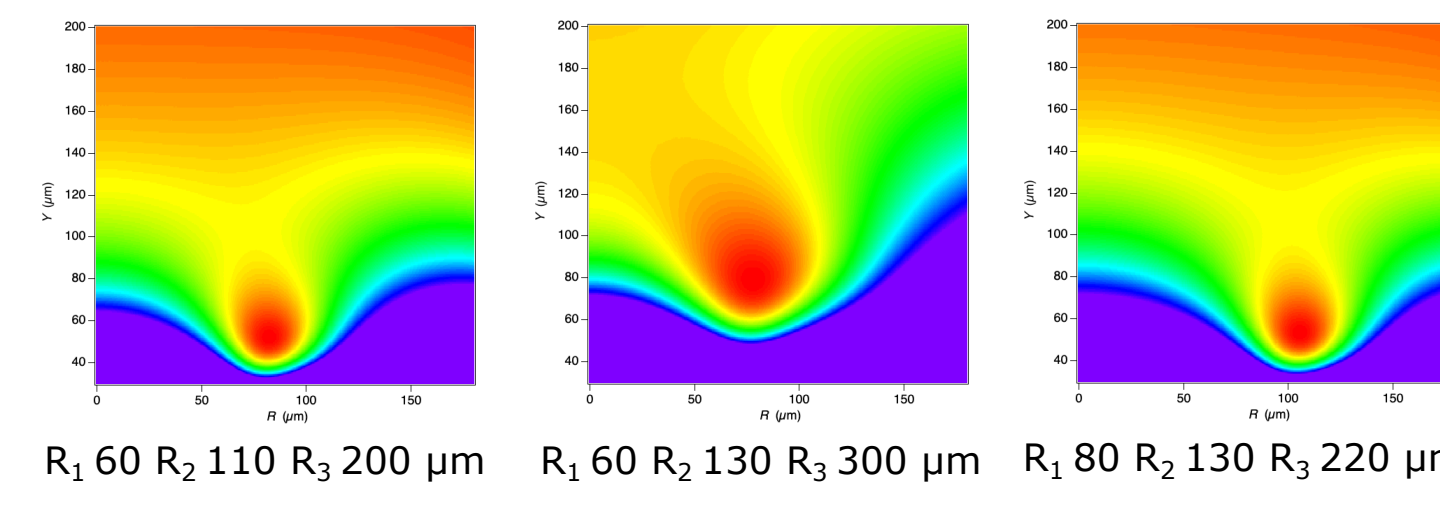
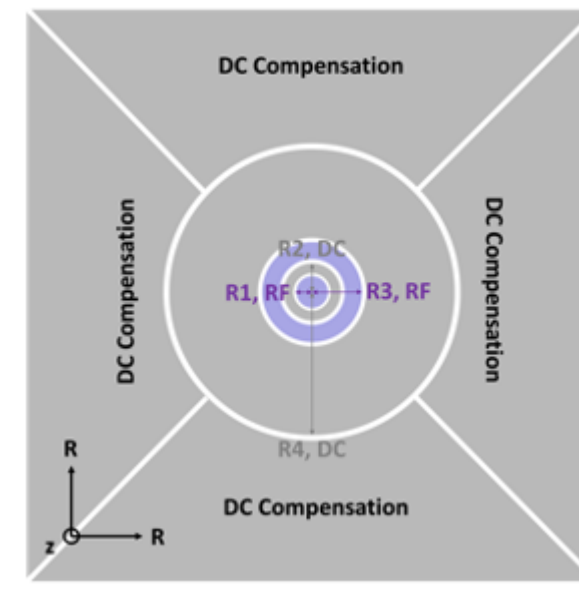

Résultats expérimentaux

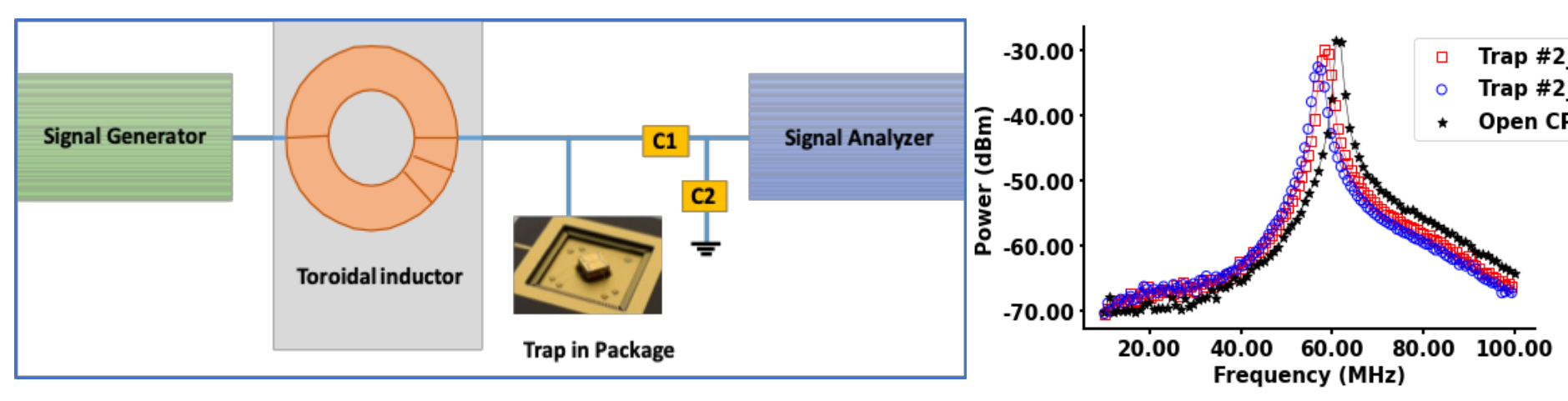
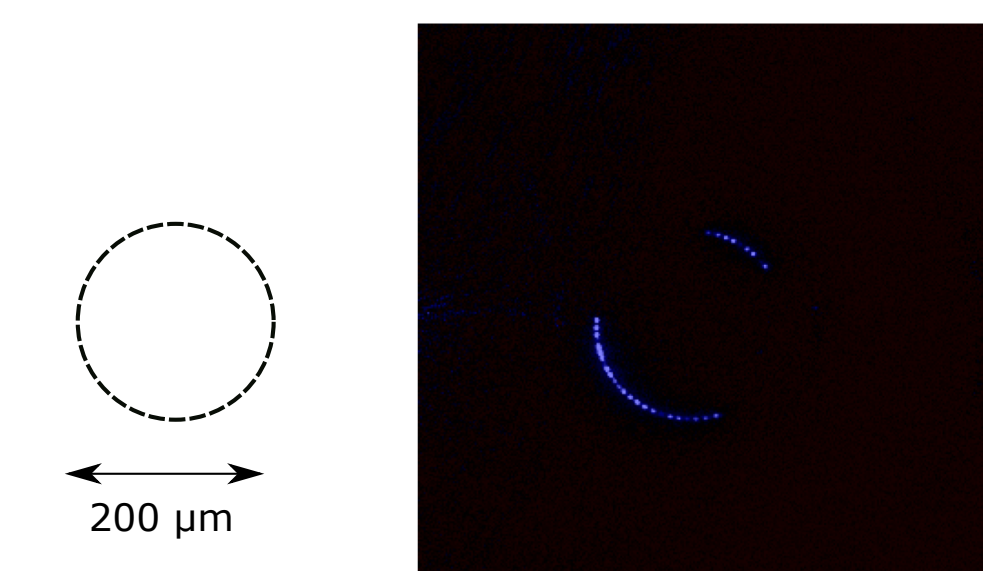
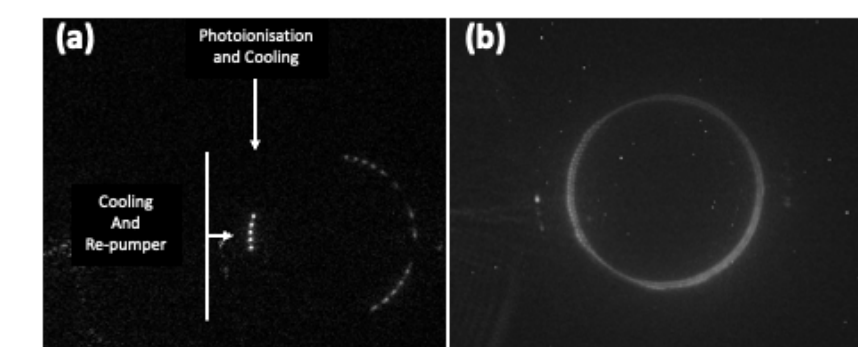
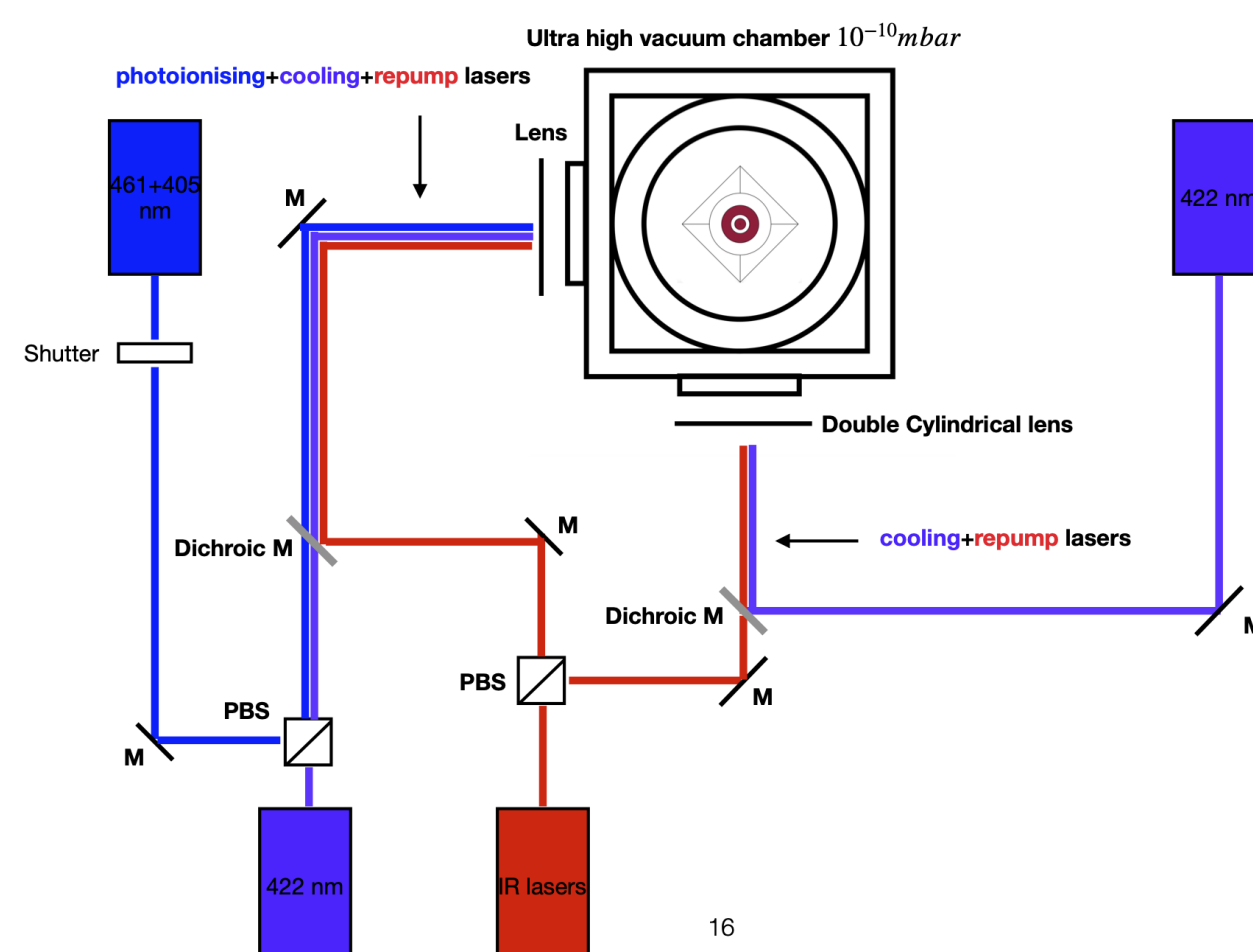
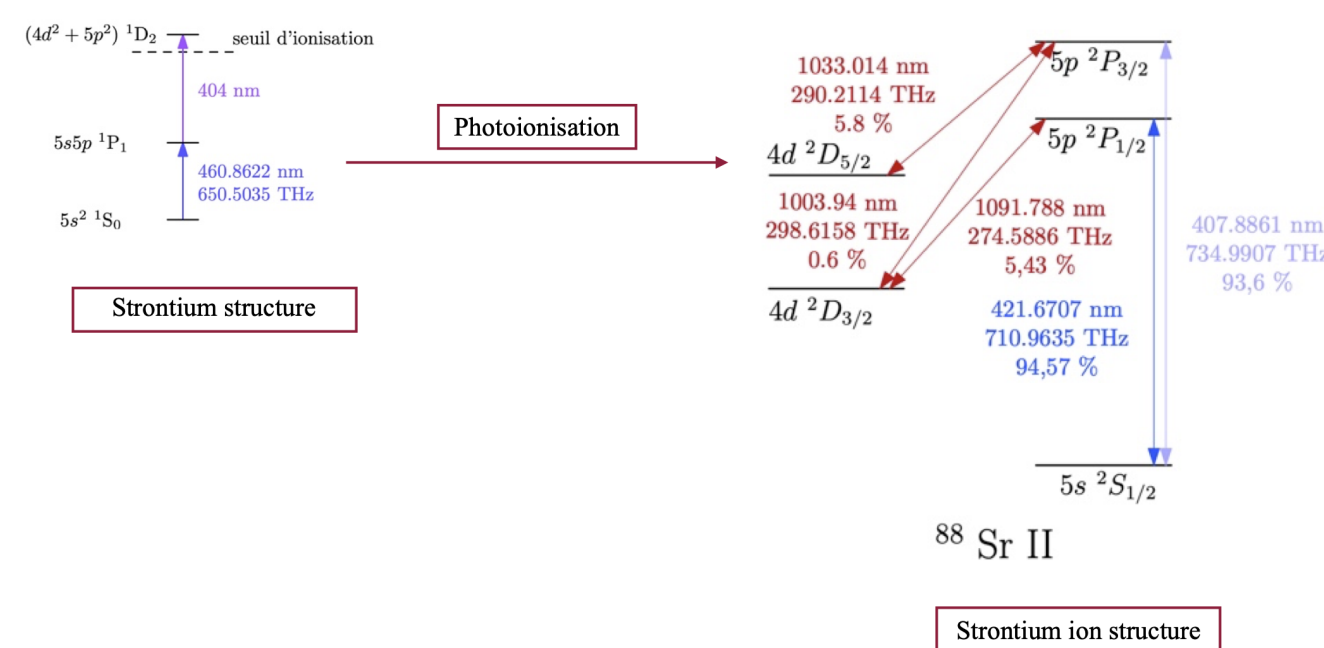
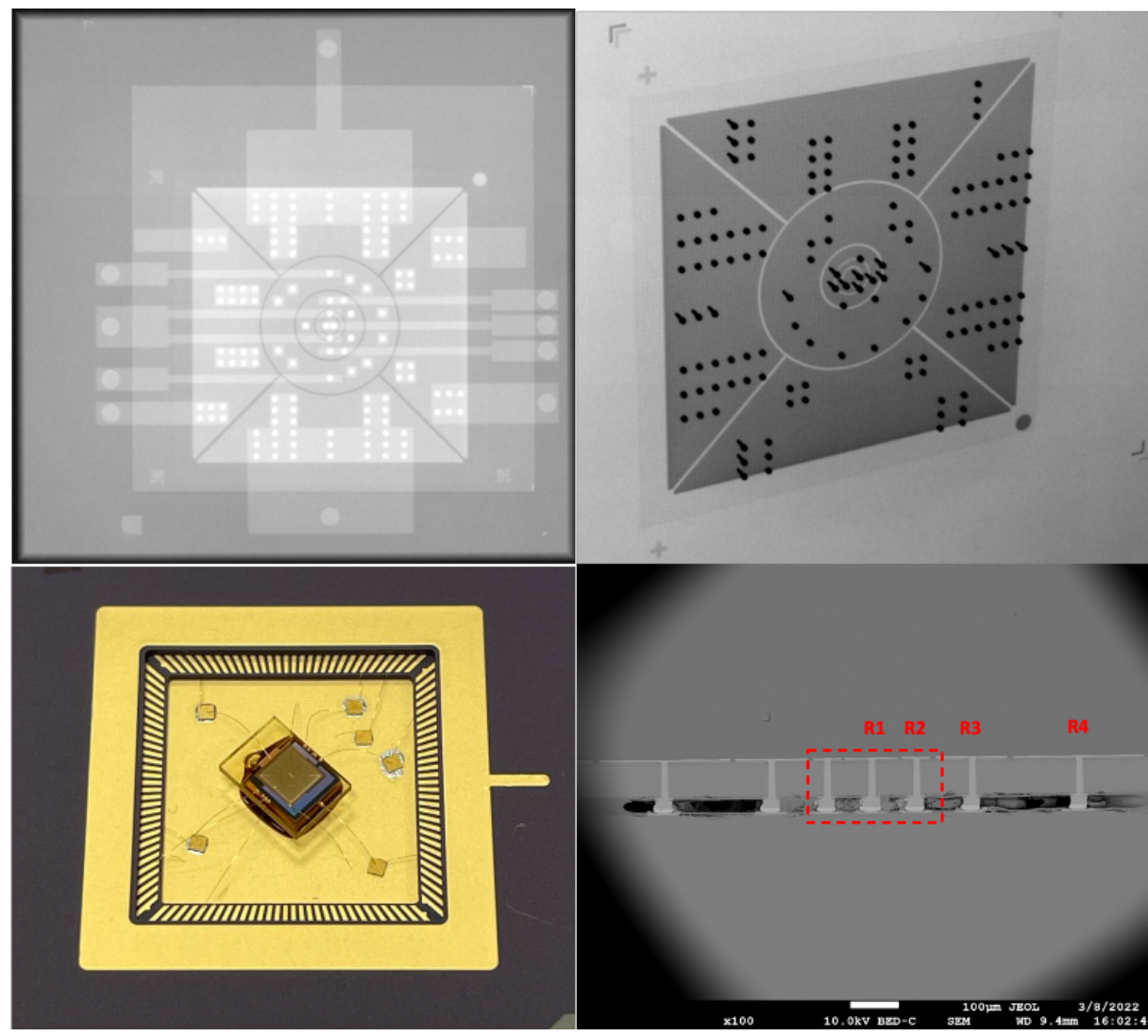

test de la dissipation RF (hors enceinte)

Prochaine étape : acheminement des faisceaux par guides d'onde intégrés (NTU / A*star collaboration)

