



**HAL**  
open science

# Impact of UV radiation on the Raman and infrared spectral signatures of sulfates, phosphates and carbonates: implications for Mars exploration

C. Royer, S. Bernard, O. Beyssac, E. Balan, O. Forni, Michel Gauthier, M. Morand, Y. Garino, P. Rosier

## ► To cite this version:

C. Royer, S. Bernard, O. Beyssac, E. Balan, O. Forni, et al.. Impact of UV radiation on the Raman and infrared spectral signatures of sulfates, phosphates and carbonates: implications for Mars exploration. *Icarus*, 2024, 410, pp.115894. 10.1016/j.icarus.2023.115894 . hal-04306160

**HAL Id: hal-04306160**

**<https://hal.science/hal-04306160v1>**

Submitted on 24 Nov 2023

**HAL** is a multi-disciplinary open access archive for the deposit and dissemination of scientific research documents, whether they are published or not. The documents may come from teaching and research institutions in France or abroad, or from public or private research centers.

L'archive ouverte pluridisciplinaire **HAL**, est destinée au dépôt et à la diffusion de documents scientifiques de niveau recherche, publiés ou non, émanant des établissements d'enseignement et de recherche français ou étrangers, des laboratoires publics ou privés.

# Impact of UV radiation on the Raman and infrared spectral signatures of sulfates, phosphates and carbonates: implications for Mars exploration

C. Royer<sup>1,2</sup>, S. Bernard<sup>3</sup>, O. Beyssac<sup>3</sup>, E. Balan<sup>3</sup>, O. Forni<sup>4</sup>, M. Gauthier<sup>3</sup>, M. Morand<sup>3</sup>, Y. Garino<sup>3</sup> and P. Rosier<sup>3</sup>

<sup>1</sup>LESIA, Observatoire de Paris, Université PSL, CNRS, Sorbonne Université, Université de Paris, Meudon, France.

<sup>2</sup>Purdue University Earth, Atmospheric and Planetary Sciences department, West Lafayette, IN, USA

<sup>3</sup>Institut de Minéralogie, Physique des Matériaux et Cosmochimie, CNRS UMR 7590, Muséum National d'Histoire Naturelle, Sorbonne Université ; Paris, France

<sup>4</sup>IRAP, CNRS, Université de Toulouse, UPS-OMP, Toulouse, France

**Abstract:** *Perseverance* is on Mars, collecting samples which will inform about Martian paleoenvironmental conditions. However, the surface of Mars is continuously bombarded by ionizing radiation, including UVs, which may significantly alter hydrated mineral phases such as sulfates, phosphates and carbonates. To explore and constrain this effect, we experimentally exposed pellets of more or less hydrated minerals to UV radiation within a Martian chamber at a temperature relevant for the rocks at the surface of Mars. Results show that exposure to UV leads to a strong alteration of the Raman and IR signals of sulfates, phosphates and carbonates. The strong increase of the luminescence signals coupled to the decrease of the Raman signals relatively to the background and the clear attenuation of the IR signals are interpreted as caused by an increasing concentration of electronic defects. The present results have strong implications for the ongoing exploration of Mars: one should not expect to detect pristine materials, except over freshly excavated surfaces. Still, as a precaution, all the targets measured or collected on Mars should be considered as having been exposed to UV radiation to some extent.

## Highlights

- The surface of Mars is continuously bombarded by ionizing radiation, including UVs.
- Here we experimentally investigate the effect of UVs on spectral signals of minerals.
- Exposure to UVs alters Raman and IR signals of sulfates, phosphates and carbonates.
- Exposure to UVs clearly enhances the creation of electronic defects.
- Such effect has to be taken into account when interpreting data collected on Mars.

1 The *Perseverance* NASA rover is exploring the Jezero crater on Mars using an arsenal of spectro-  
2 scopic tools to characterize the geological settings of the samples that will be returned to Earth (Farley  
3 et al., 2020; Maurice and Wiens, 2021; Wiens et al., 2021) by the NASA-ESA Mars Sample Return  
4 program (Meyer et al., 2022). Although the surface of Mars is globally cold and dry today, environ-  
5 ments with liquid water likely existed during the Noachian (Grotzinger et al., 2014; McMahon et al.,  
6 2018; Farley et al., 2020). A number of minerals, such as many of those belonging to the phyllosili-  
7 cate, sulfate, or carbonate groups, may have been produced via aqueous alteration processes having  
8 occurred at the surface and potentially carry invaluable information about the climatic conditions

9 that prevailed on Mars during the Noachian (Vaniman et al., 2004; Bibring et al., 2005; Poulet et al.,  
10 2005; Mustard et al., 2008; Murchie et al., 2009; Carter et al., 2010). Alternatively, other minerals  
11 like phosphates, which may crystallize during magmatic processes, may provide crucial information  
12 on the volatile content of the deep planet. Their identification and the determination of their water  
13 content may thus shed new light on the early geologic and climatic history of Mars.

14 Although infrared (IR) spectroscopy has long been used from orbit only with CRISM or OMEGA  
15 to identify minerals on Mars (Bibring et al., 2005; Poulet et al., 2005; Mustard et al., 2008; Murchie  
16 et al., 2009; Carter et al., 2010; Ehlmann et al., 2011), IR data can now be collected from the ground  
17 using the SuperCam instrument aboard *Perseverance* (Maurice and Wiens, 2021; Wiens et al., 2021;  
18 Fouchet et al., 2022). Furthermore, IR data can be directly confronted to Raman spectroscopic data  
19 collected using SuperCam (Wiens et al., 2022; Clavé et al., 2023; Beyssac et al., 2023) or SHERLOC  
20 (Bhartia et al., 2021; Scheller et al., 2022a). A similar strategy, *i.e.*, allowing both IR and Raman data  
21 to be collected on the same targets, has been adopted by ESA for Rosalind Franklin, the rover of the  
22 ExoMars mission, which will be equipped with two IR instruments (ISEM Korablev et al. 2017 and  
23 MicrOmega Bibring et al. 2017), and one Raman instrument (RLS Rull et al. 2017). The combined use  
24 of IR and Raman spectroscopies at the surface of Mars is expected to allow identification of minerals  
25 and quantification of their water content.

26 However, as is the case for organic molecules at the surface of Mars (Fornaro et al., 2018; Fox  
27 et al., 2019; Megevand et al., 2021), these minerals have been bombarded by ionizing radiation. In  
28 fact, in the absence of a global magnetic field, the thin CO<sub>2</sub> atmosphere of Mars absorbs most X-rays  
29 and far-UV radiation, but lets mid- and near-UV photons in the range 190 – 410 nm, gamma rays,  
30 solar energetic protons, and galactic cosmic rays reach the surface (Patel et al., 2002; Dartnell et al.,  
31 2007; Hassler et al., 2014). Even though UV photons do not penetrate that much below the surface  
32 (Carrier et al., 2019), they can interact with minerals exposed at the surface, altering their composition  
33 via radiolysis and their structure via the incorporation of electronic defects. Such alteration may  
34 modify their spectral responses for techniques sensitive to the crystal structure, chemical nature and  
35 hydration signature (H<sub>2</sub>O and OH), such as Raman and infrared spectroscopies (Dartnell et al., 2007;  
36 Hassler et al., 2014). This may lead to misinterpretations of the collected signals. Worse, most mineral  
37 calibration targets having served to characterize instrumental responses are terrestrial analogues which  
38 have never experienced the levels of UV radiation bombarding the surface of Mars (Manrique et al.,

39 2020). Experimentally constraining in the laboratory the impact of UV radiation on the structure,  
40 water content and spectral signatures of hydrated and non-hydrated minerals is therefore critical to  
41 properly interpret the data collected on Mars.

42 The evolution of the IR spectral signatures of sulfates, phosphates or carbonates experimentally  
43 exposed to simulated Mars surface UV radiation conditions has been investigated by a rather limited  
44 number of authors (Bish et al., 2003; Cloutis et al., 2007, 2008; Poitras et al., 2018; Turenne et al.,  
45 2022). An even lower number of studies have been dedicated to the evolution of their Raman spectral  
46 signatures (Bonales et al., 2022). Of note, extrapolating laboratory results to natural settings remains  
47 difficult, in particular because geological timescales cannot be replicated in the laboratory, questioning  
48 the intrinsic relevance of laboratory experiments. Yet, the instruments onboard *Perseverance* do  
49 not only measure rocks having been exposed to UV radiation for millions or billions of years. In  
50 fact, *Perseverance* carries an abrasion tool allowing the exposure of a patch of 5 cm diameter of  
51 pristine rock initially lying 2 to 16 mm below the surface (Moeller et al., 2020), to be studied using  
52 spectroscopic tools within a few Martian Sols. This justifies experimental investigations, even over  
53 short timescales. Following a previous study dedicated to the impact of UV radiation on organic  
54 molecules (Megevand et al., 2021), we have therefore conducted laboratory experiments to document  
55 the impact of UV radiation on the water content and structure of mineral phases of major interest in  
56 the current exploration of Mars.

57 Here, we first investigated the evolution of the Raman and IR spectroscopic signatures of initially  
58 more or less hydrated sulfates (Ca, Na, Mg, Fe, and Al-rich sulfates) during an experimental exposure  
59 to UV radiation within a Martian chamber at a temperature relevant for the rocks at the surface of  
60 Mars. Sulfates are of particular interest in the context of the Mars2020 mission as they are considered  
61 as having a high biopreservation potential (Scheller et al., 2022b), and they may also result from  
62 the interaction of water with rocks. We also conducted similar experiments for a slightly longer  
63 duration using phosphates (Ca, Na and Mg-rich phosphates) and carbonates (Ca, Na and Mg-rich  
64 carbonates) since these minerals are also of high interest for astrobiology (McMahon et al., 2018) and  
65 more generally for geology. The Raman spectra of these minerals were collected during the experiments  
66 *in situ* within the Martian chamber, while their IR spectra were collected at the end of experiments,  
67 once the irradiated samples were removed from the Martian chamber.

# 68 1 Materials and Methods

## 69 1.1 Selected minerals and general strategy

70 Five sulfates (exhibiting different hydration states), three phosphates (exhibiting different hydration  
71 states) and three carbonates (exhibiting different hydration and hydroxylation states) were selected  
72 for the present study (cf Table 1). Besides for the hydromagnesite (*i.e.*, the Mg-rich hydrocarbonate  
73 for which a natural single crystal was simply taped on a Scanning Electron Microscope stub), we used  
74 a mechanical press to prepare pellets of compressed samples (several mg of each mineral were pressed  
75 at 2 tons onto a stub of 1 cm in diameter, leading to a final thickness of about 1 mm). Irradiation  
76 experiments were conducted in a dedicated Martian chamber built by the Cellule Projet @ IMPMC  
77 (Fig. 1) (Megevand et al., 2021). In this chamber, samples are exposed to UV radiation at 0°C under  
78 a primary vacuum ( $< 1$  mbar). A Martian-like CO<sub>2</sub> atmosphere was not introduced into the chamber  
79 to prevent absorption of UV by CO<sub>2</sub> and contamination from air. Previous studies have shown that  
80 a few mbars of CO<sub>2</sub> have no influence on the UV induced degradation of amino acids (ten Kate  
81 et al., 2006), nor on the UV induced dehydration of sulfates (Bonales et al., 2022). Of note, all the  
82 samples have been introduced into the Martian chamber and exposed to the pressure and temperature  
83 conditions of the experiments for 15 hours before being exposed to UV radiation. Such exposition to  
84 low pressure and temperature conditions did not have any effect on the degree of hydration of the  
85 samples investigated here as verified using Raman spectroscopy directly performed in the chamber.  
86 Samples were then exposed to UV produced by a 150 W arc lamp equipped with a high pressure Xenon  
87 bulb (UXL-150SP - LOT-ORIEL). Note that this is the exact same lamp which the Mars Organic  
88 Molecule Irradiation and Evolution (MOMIE) setup relies on (Stalport et al., 2009, 2019; Poch et al.,  
89 2013, 2014) and which was used to document the impact of UV radiation on cystine (Megevand et al.,  
90 2021). This lamp delivers a UV spectrum (190 – 400 nm) with a pattern similar to that of the Martian  
91 surface radiation spectrum (Patel et al., 2002; Dartnell et al., 2007; Hassler et al., 2014), and a flux  
92 of the same order of magnitude as the one undergone by the Martian surface, simulating well true  
93 Martian conditions. Note that a DUV Grade Fused Silica window allowed rejecting most of the IR  
94 radiation (down to 2.89  $\mu\text{m}$ ), mitigating a potential heating of the samples by the UV lamp although  
95 the 400 nm – 2.89  $\mu\text{m}$  range is still available for radiant heating (Fig. 2). Raman spectra of starting  
96 and irradiated materials were measured directly in the Martian chamber (from 200 to 2000  $\text{cm}^{-1}$  and

97 from 3000 to 4000  $\text{cm}^{-1}$ ), that is, under the conditions of the experiments. The Raman spectra of  
 98 sulfate samples were measured before and after 30 and 270 min of exposure to UV radiation, while  
 99 those of phosphate and carbonate samples were measured before and after 5, 30, 270 and 1500 min of  
 100 exposure to UV. At the end of the irradiation experiments (*i.e.*, after 270 minutes for sulfates and after  
 101 1500 minutes for phosphates and carbonates), samples were removed from the chamber and measured  
 102 with diffuse reflectance IR spectroscopy (over the 1–2.75  $\mu\text{m}$  range). Note that the contribution of the  
 103 volume of irradiated materials to the measured signals differed from one technique to another as the  
 104 total volume probed is different for Raman and IR spectroscopies (and rather difficult to estimate),  
 105 challenging the direct comparison between the data.

Name	Formula	Ref. Sigma-Aldrich/N°CAS
Calcium sulfate dihydrate	$\text{CaSO}_4 \cdot 2\text{H}_2\text{O}$	1.02161/10101-41-4
Sodium sulfate	$\text{Na}_2\text{SO}_4$	239313/7757-82-6
Aluminum sulfate, octadecahydrate	$\text{Al}_2(\text{SO}_4)_3 \cdot 18\text{H}_2\text{O}$	227617/7784-31-8
Magnesium sulfate	$\text{MgSO}_4$	M7506/7487-88-9
Iron sulfate (III), hydrate	$\text{Fe}_2(\text{SO}_4)_3 \cdot x\text{H}_2\text{O}$	307718/15244-10-7
Calcium phosphate	$\text{Ca}_3(\text{PO}_4)_2$	21218/7758-87-4
Sodium phosphate	$\text{Na}_3\text{PO}_4$	342483/7601-54-9
Magnesium phosphate hydrate	$\text{Mg}_3(\text{PO}_4)_2 \cdot x\text{H}_2\text{O}$	344702/53408-95-0
Calcium carbonate	$\text{CaCO}_3$	10679-36/471-34-1
Sodium carbonate, decahydrate	$\text{Na}_2\text{CO}_3 \cdot 10\text{H}_2\text{O}$	1.06391/6132-02-1
Hydromagnesite	$4(\text{MgCO}_3)\text{Mg}(\text{OH})_2 \cdot 4\text{H}_2\text{O}$	<i>Natural sample</i>

**Table 1:** List of the studied samples.

## 106 1.2 Time resolved Raman and IR reflectance

107 Following [Fau et al. \(2019, 2022\)](#) and [Megevand et al. \(2021\)](#), we relied on a customized time-resolved  
 108 Raman spectrometer built by the Cellule Projet at IMPMC to collect the Raman spectra of the  
 109 samples investigated. Within the Martian chamber used here, samples are at a distance of 8 meters  
 110 from the telescope, mimicking the configuration of remote Raman measurements conducted on Mars  
 111 using SuperCam. Here, the fine control and synchronization of both time delay and gating time of the  
 112 camera allows sub-nanosecond time resolution experiments: we collected Raman signals using a 2 ns  
 113 ICCD gate centered on the 1.2 ns laser pulse. Filters are used to limit the laser irradiance at the surface  
 114 of samples below  $10^{10} \text{ W/m}^2$  to prevent any laser-induced damage ([Fau et al., 2019](#)). In the remote  
 115 setting, the laser is collimated at the sample surface 8 m from the telescope Schmidt plate on a spot of



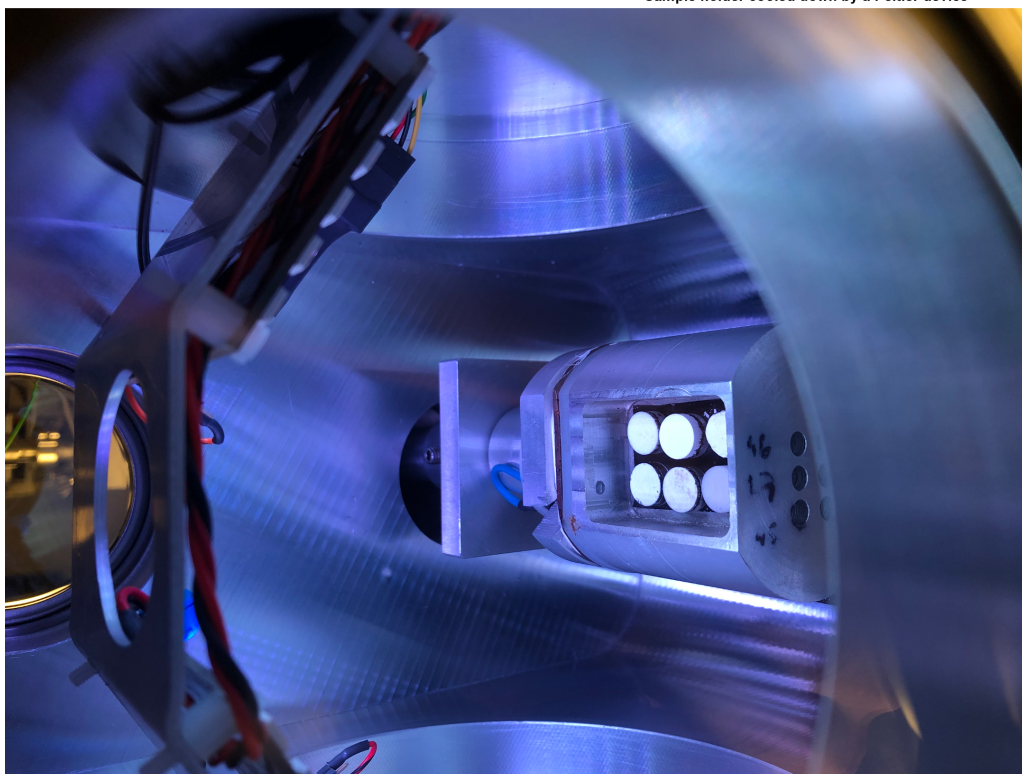
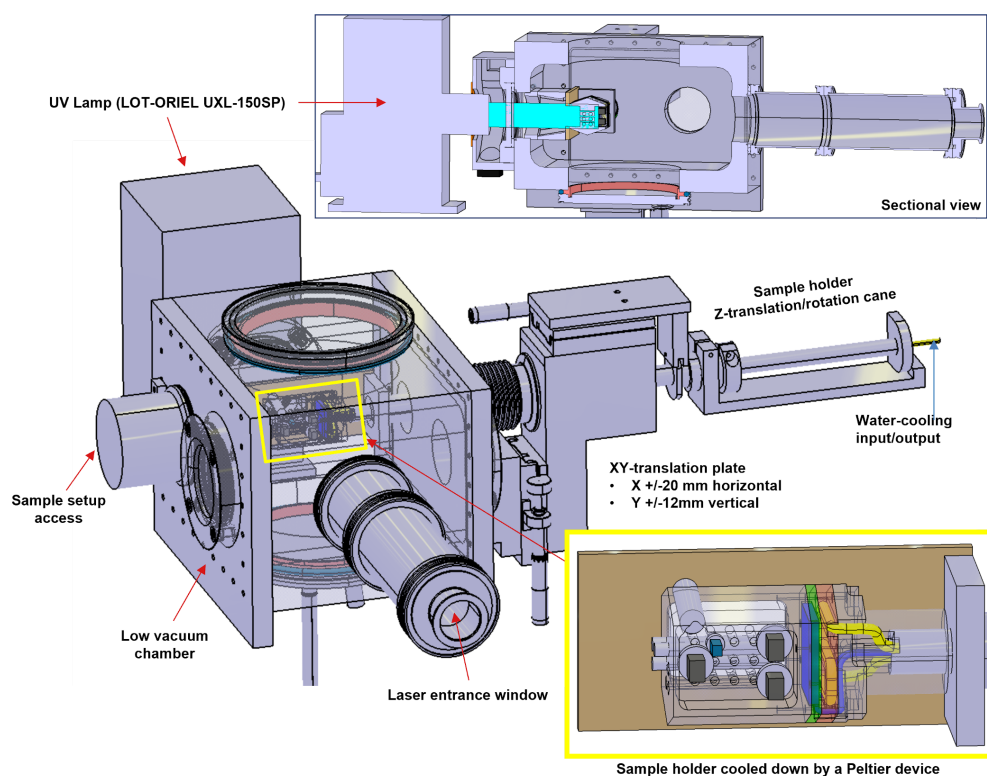

**Figure 1:** Top: CAD images of the chamber, its illumination device and the sample holder mechanism. Bottom: Picture of the vacuum chamber containing the samples (the 6 cylindrical pellets) seen from the Raman measurement side. The plate can translate in two degrees of freedom to center each pellet in the laser beam. The pierced plate in the foreground contains an illumination system to facilitate the positioning of the pellets.

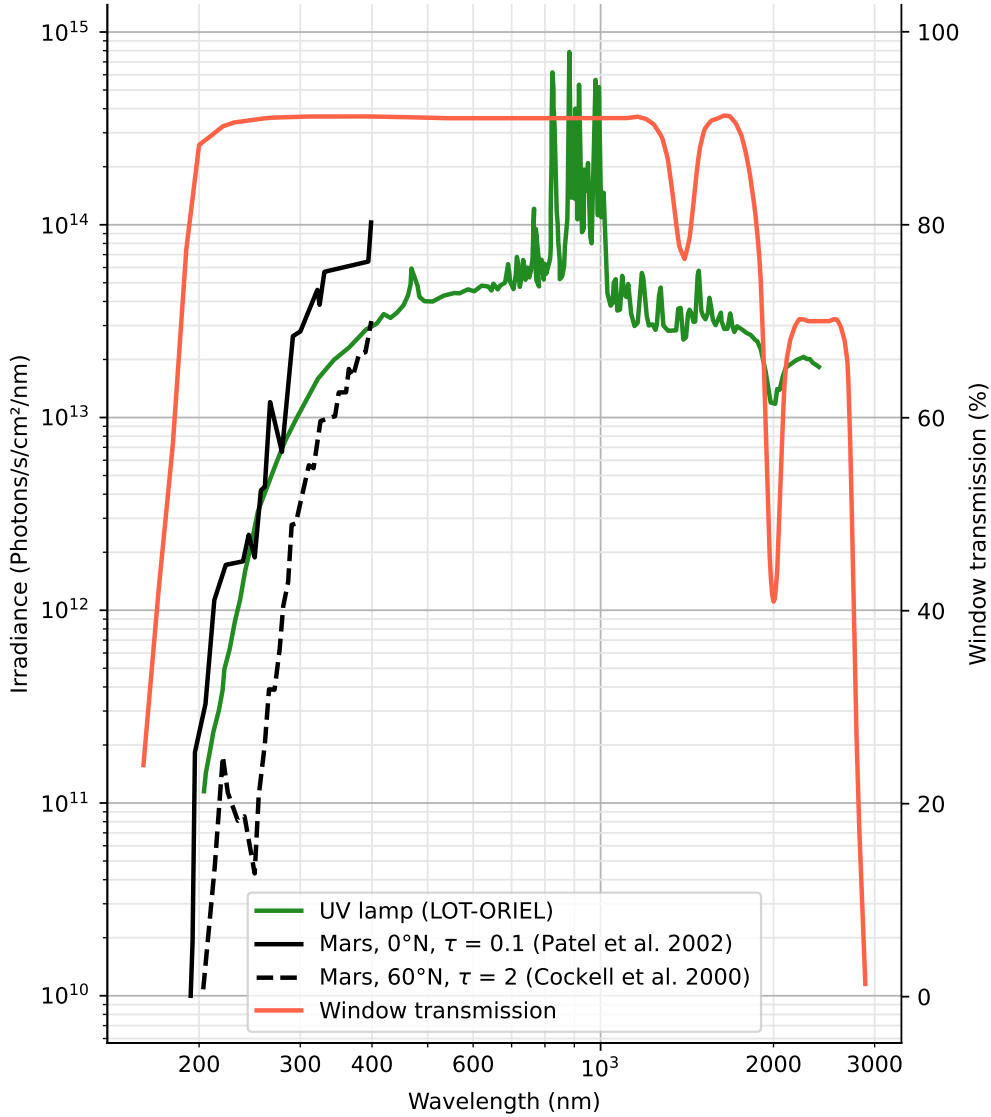

**Figure 2:** Irradiance spectra of the lamp (green line) compared to the sun at the Martian equator and under clear atmosphere (solid black line) and at N 60° latitude under more opaque atmosphere (dashed line), in the UV range; transmission spectrum of the fused silica window (red line).

116  $\sim 6$  mm diameter, and the Raman signal is collected by a conventional Schmidt-Cassegrain telescope  
 117 (Celestron-C8 202 mm diameter Schmidt plate) on a spot of  $\sim 5$  mm diameter co-aligned with the laser  
 118 spot. After the telescope, a notch filter cuts off the Rayleigh scattering at  $\sim 90$  cm<sup>-1</sup> and the signal  
 119 is collected by an optical fiber and sent into the modified Czerny-Turner spectrometer coupled with  
 120 the intensified ICCD camera. This spectrometer has three motorized gratings that can be selected  
 121 depending on the spectral window and spectral resolution requested. Here, we used a 600 gr/mm  
 122 grating yielding a spectral resolution of about 10–12 cm<sup>-1</sup>, *i.e.*, spectral resolution similar to that



123 of the SuperCam instrument. To maximize the signal-to-noise ratio (SNR), we accumulated signals  
124 collected over  $10^6$  laser shots. We also collected the luminescence signal with no Raman contribution  
125 using a 100  $\mu\text{s}$  ICCD gate opened just after the laser pulse (Fau et al., 2019, 2022; Megevand et al.,  
126 2021).

127 IR reflectance data were collected with a commercial Fourier transform spectrometer Nicolet 6700  
128 FTIR operating at IMPMC over the 1 to 2.7  $\mu\text{m}$  spectral range with a spectral resolution of  $1\text{ cm}^{-1}$ ,  
129 allowing for the detection of features related to hydration ( $\text{H}_2\text{O}$  vibrations) and structure ( $\text{CO}_3^{2-}$  and  
130  $\text{SO}_4^{2-}$ ). The acquired spectra were divided by a blank (a silver mirror) before any further processing.  
131 After being removed from the Martian chamber and prior to IR analysis, samples were conserved in  
132 a dry environment at low temperature in a cold room.

## 133 2 Results

### 134 2.1 Starting materials

135 The Raman and IR spectra of sulfates, phosphates and carbonates are extensively described in the  
136 literature (cf for instance Wang et al. 2006; Buzgar et al. 2009; Ben Mabrouk et al. 2013 for sulfates,  
137 Fau et al. 2022 for phosphates, and Gunasekaran et al. 2006; Harner and Gilmore 2015 for carbonates).  
138 For all these minerals, the most intense Raman peak is due to the  $\nu_1$  symmetric stretching mode of  $\text{SO}_4$ ,  
139  $\text{PO}_4$  and  $\text{CO}_3$  and located at  $\sim 1010\text{ cm}^{-1}$ ,  $\sim 960\text{ cm}^{-1}$  and  $\sim 1085\text{ cm}^{-1}$  for sulfates, phosphates and  
140 carbonates respectively. Additional peaks due to these molecular groups are the doubly degenerate  
141  $\nu_2$  bending mode at  $\sim 450\text{ cm}^{-1}$  and  $\sim 430\text{ cm}^{-1}$  for sulfates and phosphates respectively (the  
142  $\nu_2$  vibration peak is not observed in our carbonate samples), the triply degenerate antisymmetric  $\nu_3$   
143 stretching mode at  $\sim 1160\text{ cm}^{-1}$ ,  $\sim 1060\text{ cm}^{-1}$  and  $\sim 1470\text{ cm}^{-1}$ , and the triply degenerate  $\nu_4$  bending  
144 mode at  $\sim 640\text{ cm}^{-1}$ ,  $\sim 580\text{ cm}^{-1}$  and  $\sim 720\text{ cm}^{-1}$ , always for sulfates, phosphates and carbonates  
145 respectively. Last, some lattice modes may be detected in these phases at lower wavenumbers. When  
146 present,  $\text{H}_2\text{O}$  contributes a broad band at  $\sim 3400\text{--}3600\text{ cm}^{-1}$ , while  $\text{HO}^-$  contributes one or several  
147 sharp bands in the range  $\sim 3500\text{--}3700\text{ cm}^{-1}$  (Fig. 3a, b, c).

148 The near infrared spectra of these materials show numerous absorption bands attributed to different  
149 overtones of the stretching ( $\nu_1$  and  $\nu_3$ ) and bending ( $\nu_2$  and  $\nu_4$ ) vibrations of the structural anion  
150 ( $\text{SO}_4^{2-}$ ,  $\text{CO}_3^{2-}$  or  $\text{PO}_4^{3-}$ ) combined with the vibrations of water present in the crystal or adsorbed

151 on its surface. In sulfates, we find similar spectra with absorptions at 1.2, 1.5 (triplly degenerate in  
152 particular in  $\text{CaSO}_4 \cdot 2\text{H}_2\text{O}$ ), 1.75, 1.92 and 2.25  $\mu\text{m}$ . The carbonate samples show a wider range  
153 of spectra, with the main absorption bands related to structural water in  $\text{Na}_2\text{CO}_3$  and to  $\text{CO}_3$  in  
154  $\text{CaCO}_3$  (at 2.34 and 2.53  $\mu\text{m}$ ). Hydromagnesite shows in addition an absorption band around 1.4  $\mu\text{m}$   
155 assigned to the first overtone of the OH stretch and around 1.9  $\mu\text{m}$  corresponding to the combination of  
156 stretching and bending of  $\text{H}_2\text{O}$ . Finally the phosphates present few spectral signatures in the infrared,  
157 except a band at about 1.9  $\mu\text{m}$  related to the stretching and bending vibrations of water (Fig. 3d, e,  
158 f).

## 159 **2.2 Evolution of sulfates with increasing irradiation**

### 160 **2.2.1 Luminescence**

161 The luminescence signal (collected using a 100  $\mu\text{s}$  ICCD gate opened just after the laser pulse) strongly  
162 increases with increasing irradiation duration (Fig. 4). The increase of this luminescence roughly  
163 follows a first-order logarithmic law with time (Fig. 4f), highlighting that UV radiation has had the  
164 most impact at the beginning of the experiments. This luminescence seems to have a short lifetime,  
165 since most of it is not rejected even when using a 2 ns ICCD gate centered on the 1.2 ns laser pulse to  
166 collect the signal. Because of this strong luminescence contribution, the Raman spectra collected in  
167 the present study have all been normalized to the total signal received by the spectrometer, to discuss  
168 the evolution of the Raman signal relative to the background contribution (Fig. 5).

### 169 **2.2.2 Raman signal**

170 The Raman signal of sulfates (*i.e.*, the Raman peaks of the signal collected using a 2 ns ICCD  
171 gate centered on the 1.2 ns laser pulse) decreases with increasing irradiation duration relative to  
172 the background contribution as shown when data are normalized to the total signal received by the  
173 spectrometer (Fig. 5). Irradiation seems to be responsible for a modification of the background  
174 shape (*i.e.*, the slope of the background has increased with increasing irradiation duration). After  
175 270 minutes of irradiation, only the main  $\nu_1$  peak can still be observed. No new peak is observed in  
176 any of the spectra of the irradiated sulfates. After removal of the background, peaks were fitted using  
177 Lorentzian functions which areas were normalized to those of the functions used to fit the peaks of the  
178 starting materials. This parameter decreases exponentially as a function of the duration of irradiation

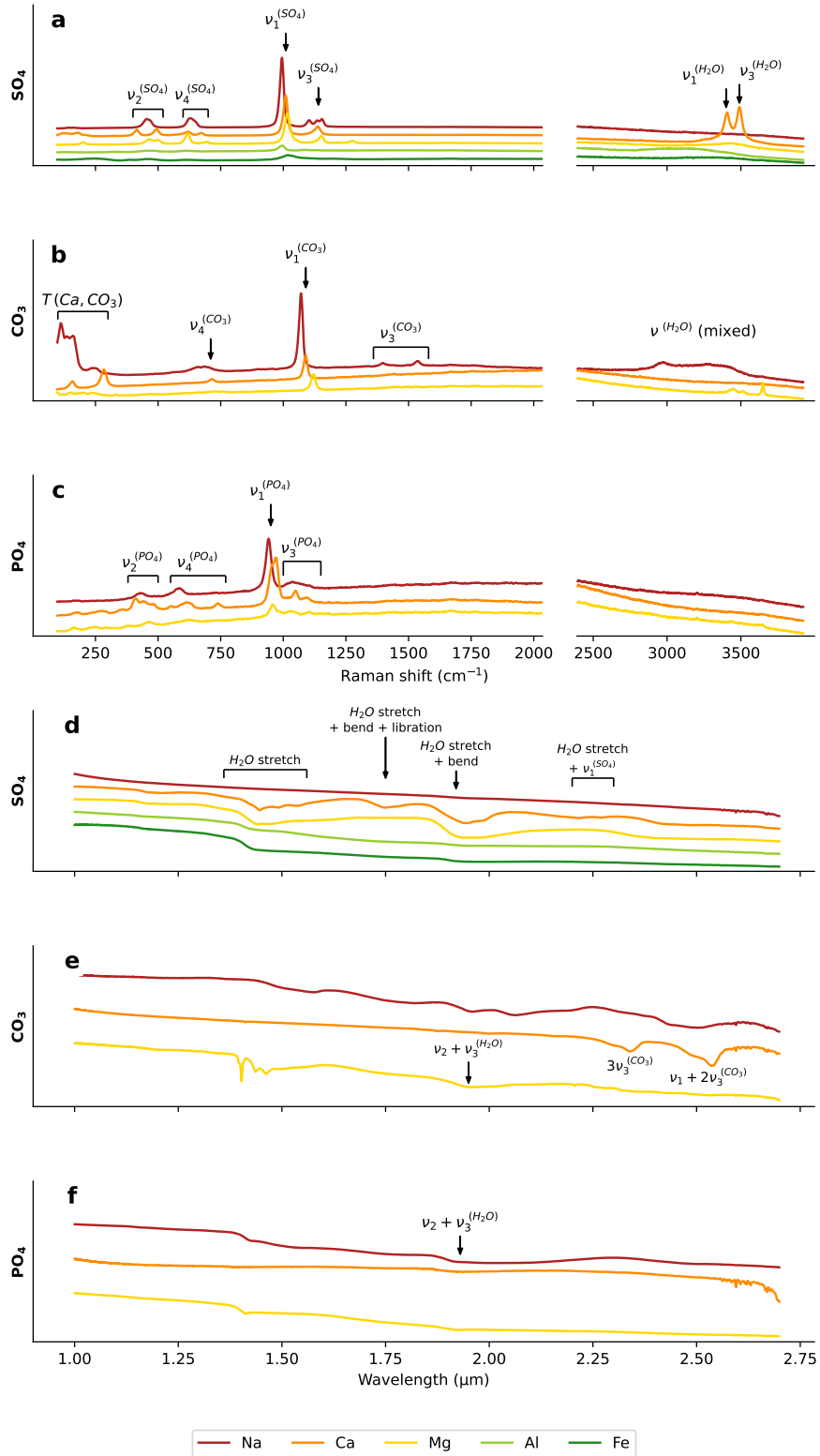

**Figure 3:** Raman (a, b, c) and IR (d, e, f) spectra of the studied minerals before irradiation, normalized and shifted for clarity. The attribution of their main features is indicated. More details about the attribution of the sulfates near-IR absorption features are given in Supplementary materials.

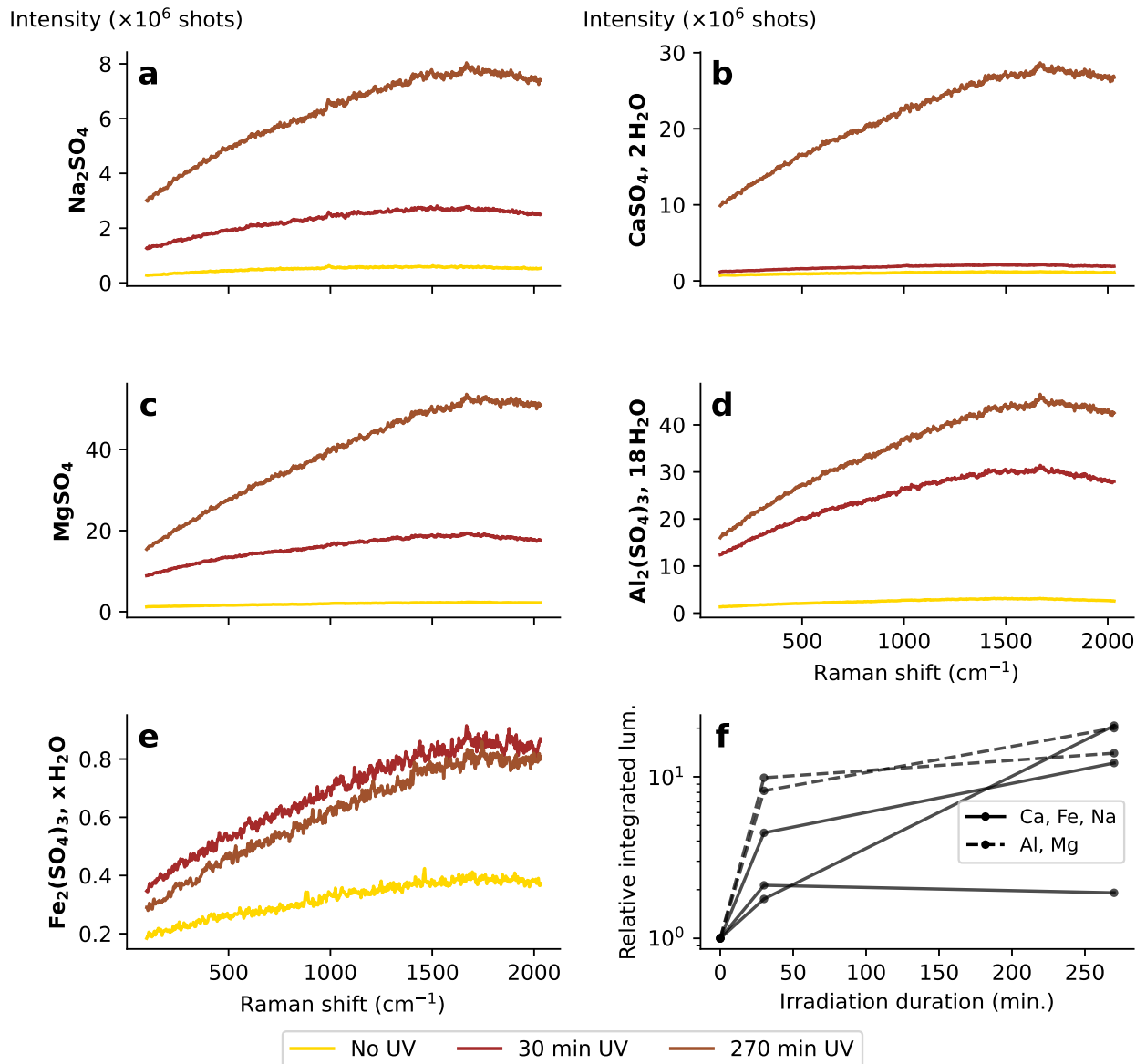
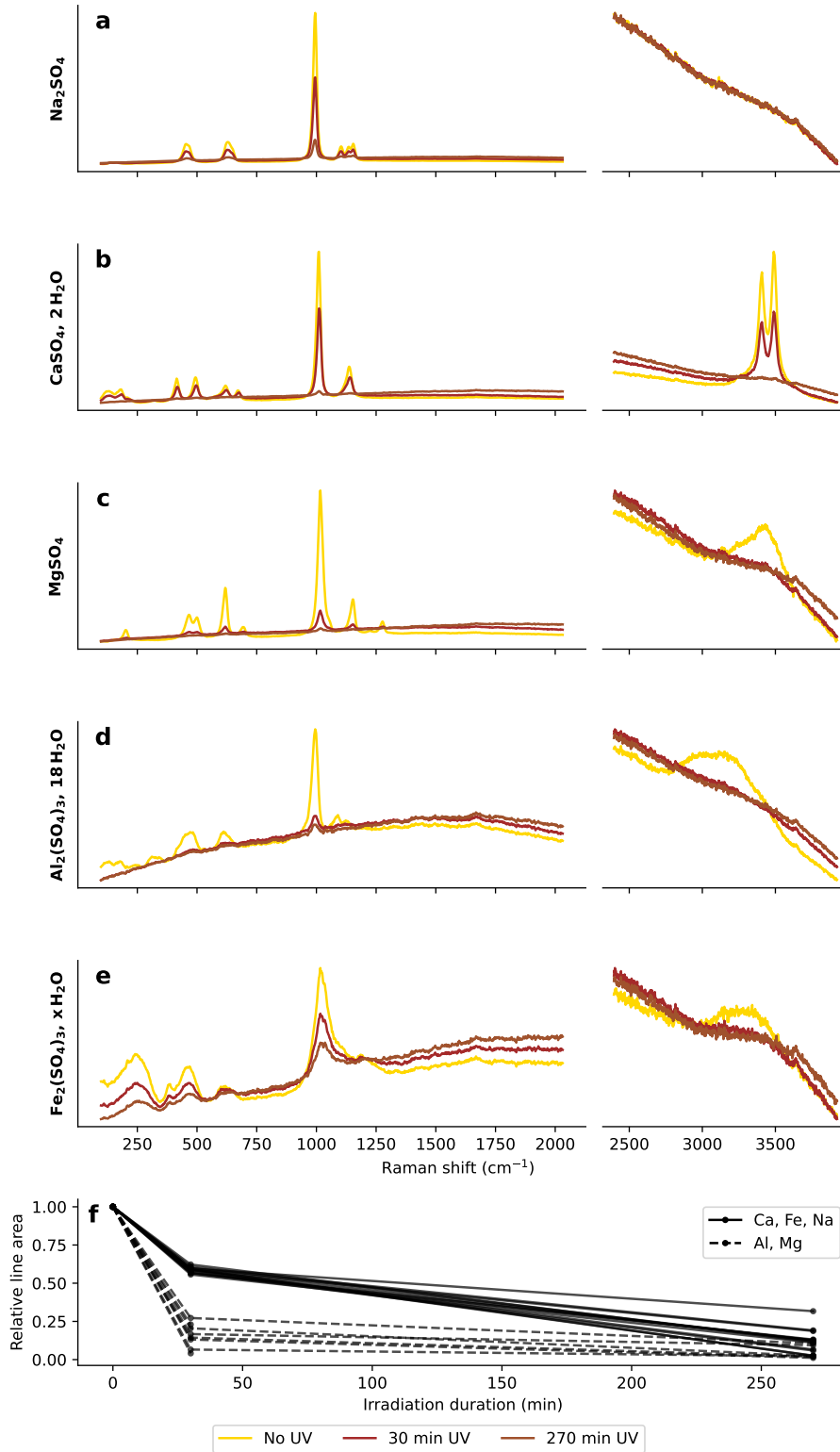

**Figure 4:** a to e: Raw luminescence spectra of sulfate samples as a function of irradiation duration. f: Relative total integrated luminescence as a function of the irradiation duration for each sulfate sample.

179 (Fig. 5f), highlighting, as for the luminescence, that the impact of UV radiation was maximum at the  
 180 beginning of the experiments.

### 181 2.2.3 Raman-based water detection

182 The specific sub-peak structures in their Raman water bands at about  $3400 \text{ cm}^{-1}$  provide direct  
 183 information on the hydration states of sulfates (Wang et al., 2006). The sulfates selected for the  
 184 present experiments initially exhibit different hydration states, from anhydrous ( $\text{Na}_2\text{SO}_4 \cdot 0\text{H}_2\text{O}$ ) to



**Figure 5:** a to e: Raman spectra of the various sulfate minerals measured with a 2 ns gate. The spectra have been normalized by their total surface to highlight their relative variation. f: relative area of each major Raman scattering line as a function of the irradiation duration.

185 highly hydrated ( $\text{Al}_2\text{SO}_4 \cdot 18\text{H}_2\text{O}$ ). Besides for the Na-rich sulfate, the exposure of sulfates to UV  
186 irradiation appears to be responsible for the disappearance of the peaks related to the structural  
187 water they initially contain. In fact, with the exception of the Ca-rich sulfate, all the initially hydrated  
188 sulfates investigated do not anymore show Raman hydration feature at about  $3400\text{ cm}^{-1}$  (Fig. 5).  
189 This is also the case for the Ca-rich sulfate after 270 minutes of irradiation.

#### 190 2.2.4 IR signal

191 At the end of the irradiation experiments (*i.e.*, after 270 minutes of exposure to UV), the sulfates  
192 investigated were measured with IR spectroscopy and their spectra were compared to those of the  
193 starting materials (Fig. 6). The absorption bands corresponding to the stretching/bending vibrations  
194 of the  $\text{H}_2\text{O}$  and OH groups, to various combinations of these modes and to overtones with  $\text{SO}_4$  modes  
195 (*e.g.*, at 2.217 and 2.268  $\mu\text{m}$  in gypsum), can still be observed in the near-IR reflectance spectra  
196 of the sulfates having been exposed to UV radiation for 270 minutes. The observed enlargement of  
197 the absorption bands after exposure to UVs indicate the creation of electronic defects rather than  
198 dehydration. Of note, atmospheric water may have been adsorbed onto the samples during their  
199 storage at  $0^\circ\text{C}$  before NIR measurements despite the presence of a desiccant.

### 200 2.3 Evolution of phosphates and carbonates with increasing irradiation

201 The phosphates and carbonates investigated here were exposed to UV radiation conditions similar  
202 to those to which sulfates were exposed, but for a slightly longer duration. The luminescence and  
203 Raman signals of the phosphates and carbonates were collected after 5, 30, 270 and 1500 min of  
204 exposure to UV and compared to the spectra of the starting materials (Figs. 7 - 8). As observed  
205 for sulfates, the luminescence signals of phosphates and carbonates strongly increase with increasing  
206 irradiation duration, and their Raman signals decrease with increasing irradiation duration relative  
207 to the background contribution. Note that, as for sulfates, the Raman spectra of phosphates and  
208 carbonates have all been normalized to the total signal received by the spectrometer. Irradiation seems  
209 to be also responsible for a modification of the background shape (*i.e.*, the slope of the background  
210 has increased with increasing irradiation duration). After 1500 minutes of irradiation, only the main  
211 peaks of phosphates and carbonates can still be observed (*i.e.*, the  $\nu_1$  peaks at about  $960\text{ cm}^{-1}$  and  
212  $1085\text{ cm}^{-1}$ , of  $\text{PO}_4^{3-}$  and  $\text{CO}_3^{2-}$ , respectively). No new peak is observed in any of the spectra of the

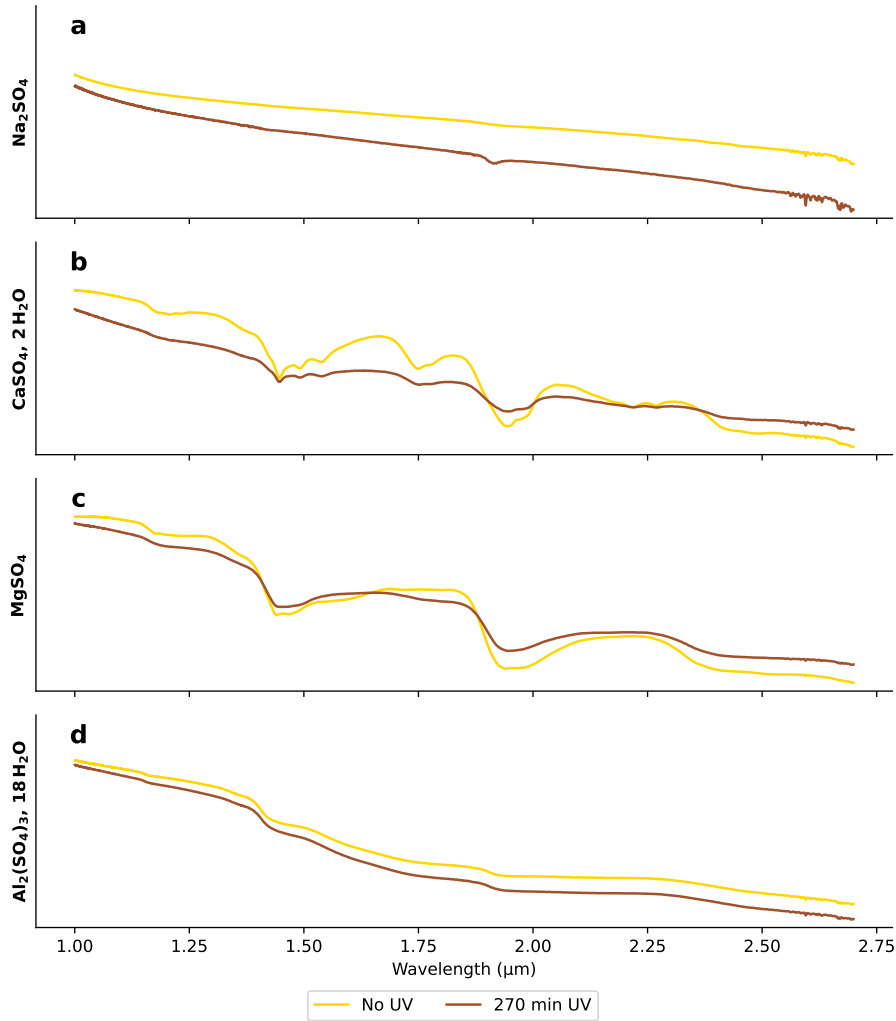

**Figure 6:** Near-infrared spectra of sodium sulfate (a), calcium sulfate (b), magnesium sulfate (c) and aluminum sulfate (d).

213 irradiated phosphates and carbonates. As for sulfates, results of peak fitting reveal that the decrease  
 214 of the Raman signal decreases exponentially as a function of the duration of irradiation (Figs. 7d –  
 215 8d), highlighting, as the luminescence is exponential, that UV radiation has had the most impact at  
 216 the beginning of the experiments.

217 Of note, the Raman signal of phosphates evolves a bit faster with experiment duration (peak  
 218 decrease and background increase) than that of carbonates, suggesting a priori that phosphates are  
 219 less resistant to UV than carbonates. But this may be related to the ratio of the volume effectively  
 220 probed by Raman to the volume effectively affected by UV radiation. A higher contribution to the  
 221 signal of a pristine volume of sample (*i.e.*, a volume unaffected by UV) would artifactually indicate a  
 222 higher resistance to UV. For instance, the hydromagnesite seems to be the most UV-resistant sample



223 of all the samples investigated here, but it is also the only transparent monocrystal investigated (all the  
224 other samples were pressed into pellets). For instance, the volume of pristine hydromagnesite *in fine*  
225 contributing to the Raman spectra collected on this target may thus be a lot larger than the volumes  
226 of the pristine parts of the other samples contributing to the measured signals, thereby artifactually  
227 minimizing the effect of exposure to UV on the Raman signal. Most of the phosphates investigated  
228 here were nominally anhydrous, except for the magnesium phosphate, and thus exhibited no Raman  
229 water bands at about  $3400\text{ cm}^{-1}$  and  $3600 - 3700\text{ cm}^{-1}$  for OH in hydromagnesite. Still, the negative  
230 slope of the background collected from  $2500$  to  $3700\text{ cm}^{-1}$  on phosphates has changed, becoming less  
231 negative with increasing irradiation. Things seem different for carbonates: the signal collected on  
232 the Ca-carbonate, nominally anhydrous, has not changed during exposition to UV. In contrast, the  
233 exposure to UV has been responsible for the non detection of the Raman peaks related to structural  
234 water initially present in the Na and Mg-carbonates, without modifying the slope of the background  
235 collected from  $2500$  to  $3700\text{ cm}^{-1}$ .

236 NIR data are consistent with Raman data. The near-IR spectra of phosphates have not changed  
237 that much during the experiments, but only a gentle absorption band related to hydration at  $1.9\text{ }\mu\text{m}$   
238 was observed in the spectra of the starting materials. The near-IR spectra of the Ca and Na-carbonates  
239 have not changed that much neither during exposure to UV, in contrast to that of the initially hydrated  
240 Mg-carbonate (hydromagnesite): the  $1.9\text{ }\mu\text{m}$  band related to structural  $\text{H}_2\text{O}$  turned shallower whereas  
241 the  $1.45\text{ }\mu\text{m}$ , attributed to hydroxyl groups, remained the same, although enlarged, which suggests  
242 a possible dehydration of the sample induced by irradiation (or local heating) and/or a creation of  
243 electronic defects.

## 244 **3 Discussion**

### 245 **3.1 Impact of exposure to UV radiation**

246 Although their surface color have become a little more yellow under UV, the Raman spectra of the  
247 sulfates, phosphates and carbonates exposed to UV under Mars conditions still exhibit the main feature  
248 observed in the Raman spectra of the starting materials, *i.e.*, the peak attributed to the  $\nu_1$  symmetric  
249 stretching modes. This shows that the minerals investigated here can withstand simulated Martian  
250 conditions (including UV radiation) for a certain time, although longer exposure to UV radiation may

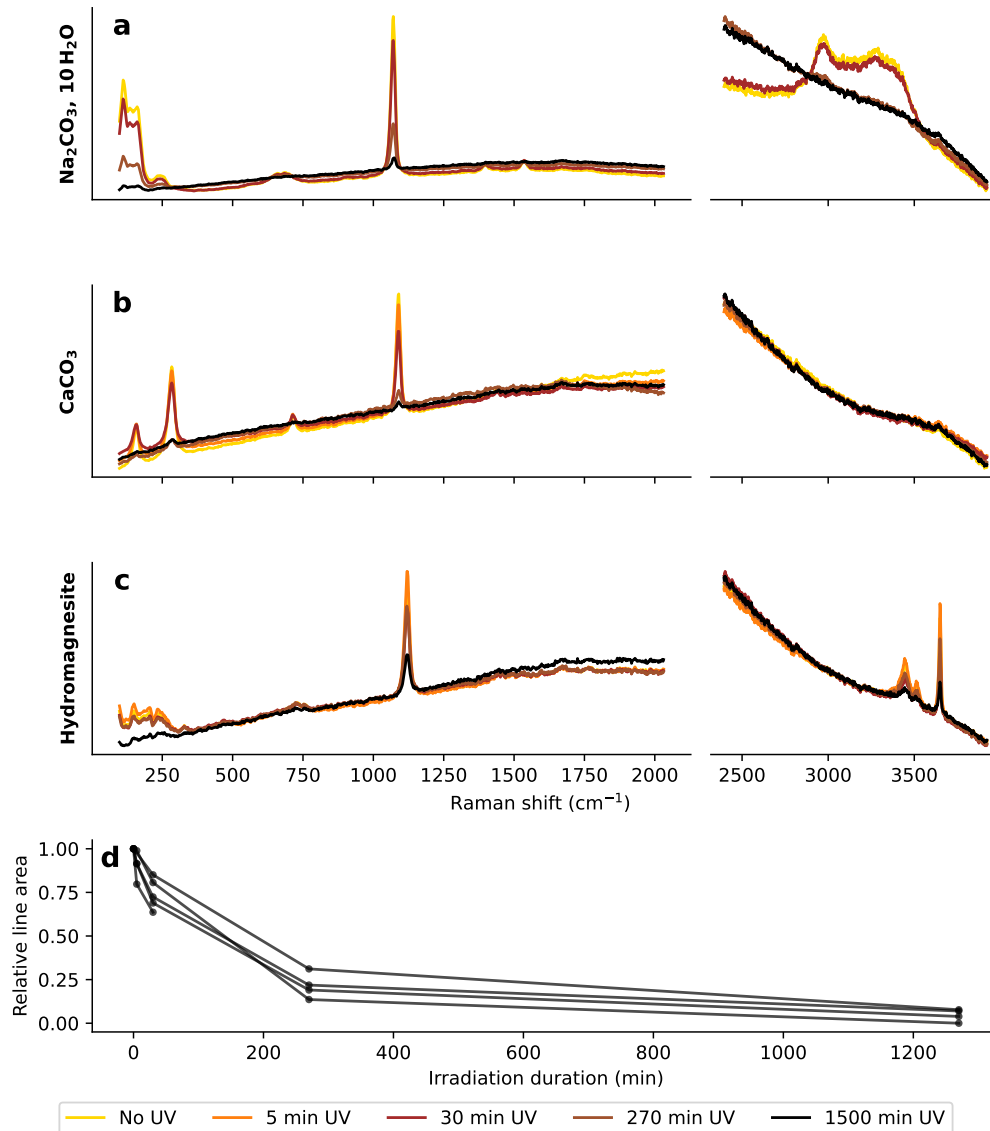

**Figure 7:** a to c: Raman spectra of the various carbonate minerals measured with a 2 ns gate. The spectra have been normalized by their total surface to highlight their relative variation. d: relative area of each major Raman scattering line as a function of the irradiation duration.

251 lead to the strong alteration of their structure at the surface, which will strongly affect both IR and  
 252 Raman signals, as anticipated by earlier experimental studies (Mukhin et al., 1996). The non detection  
 253 of new peak indicate that no transitory phase nor new species have formed during the experiments.  
 254 Still, a short exposure to UV has been responsible for a strong increase of the luminescence signal of all  
 255 the minerals investigated, and for a strong decrease of their Raman signal relative to the background  
 256 contribution. As is the case for organics exposed to UV radiation under Mars conditions (Megevand  
 257 et al., 2021), such evolution could be caused by an increasing concentration of electronic defects

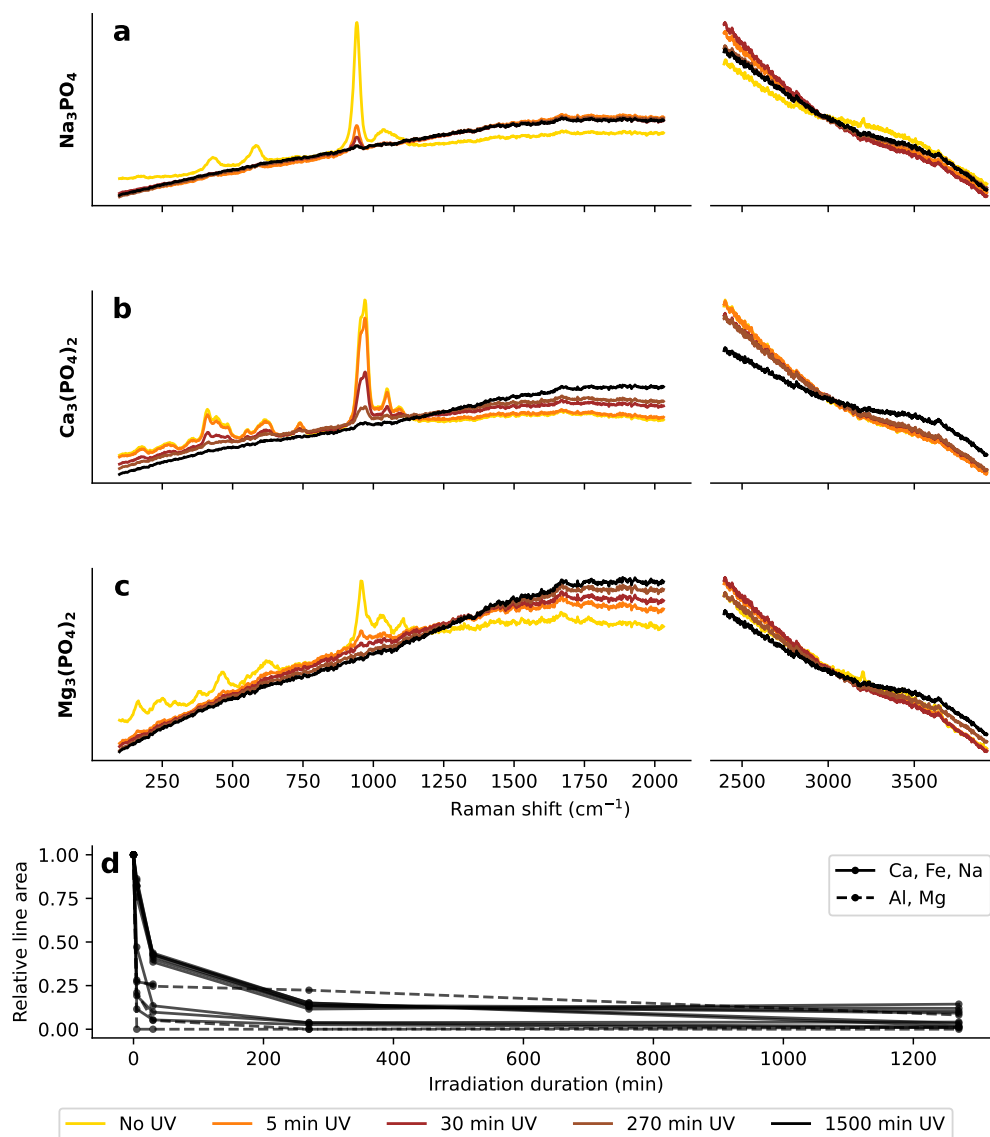

**Figure 8:** a to c: Raman spectra of the various phosphate minerals measured with a 2 ns gate. The spectra have been normalized by their total surface to highlight their relative variation. d: relative area of each major Raman scattering line as a function of the irradiation duration.

258 contributing to the background. In fact, previous ESR (Electronic Spin Resonance) investigations  
 259 have reported the creation of radical species in carbonates exposed to UV light (Bartoll et al., 2000;  
 260 Kabacińska et al., 2017, 2019). An increase in the concentration of point defects may also explain  
 261 the broadening of IR bands observed for all samples investigated here, as previously reported for a  
 262 number of materials exposed to ionizing radiation (*e.g.*, Fourdrin et al. 2009; Megevand et al. 2021.  
 263 Of note, these defects do not seem to be luminescing centers: concentration quenching would decrease  
 264 the lifetime of luminescence, as reported for both organic and inorganic materials (Chen and Knutson,

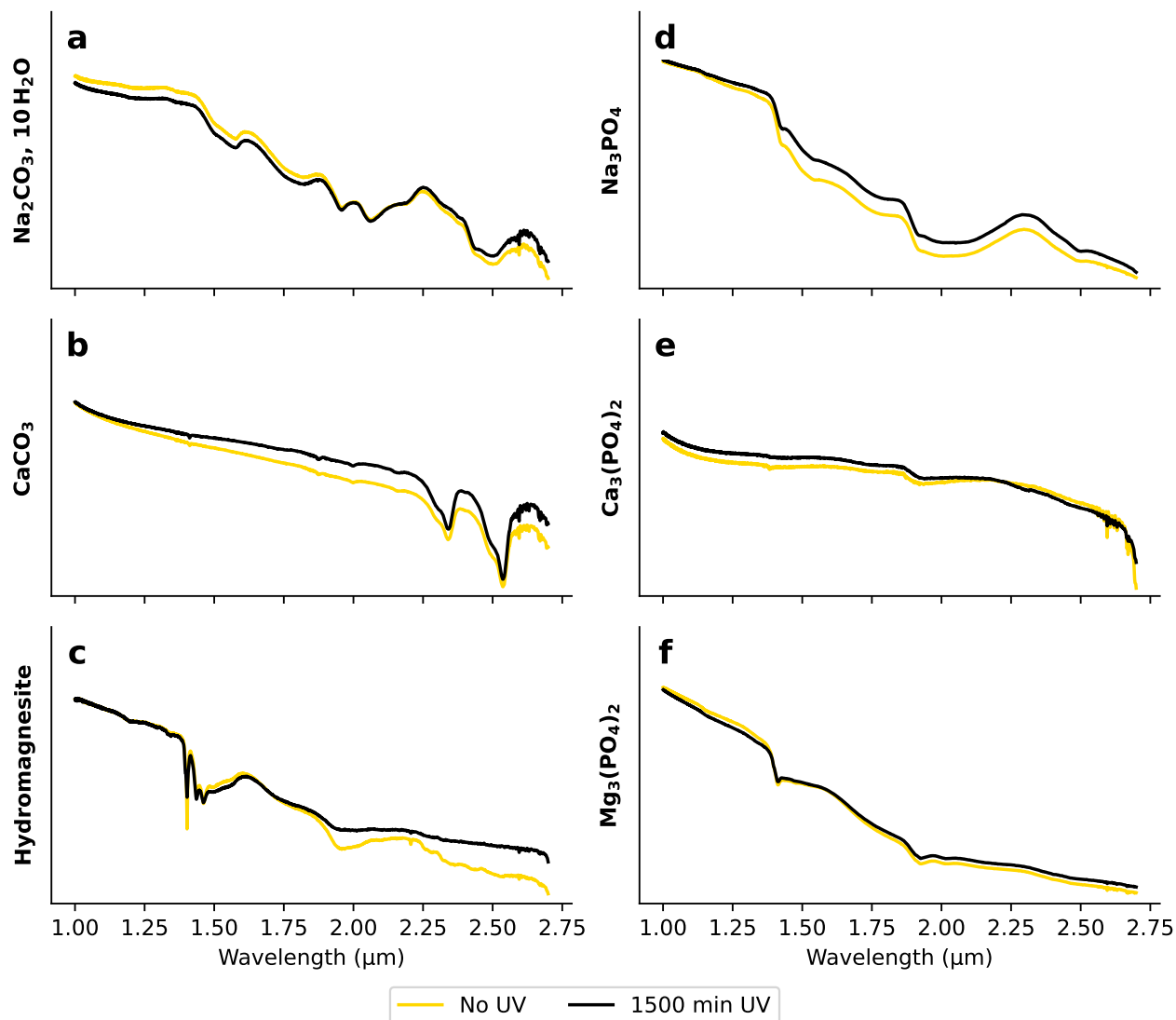

**Figure 9:** Near-infrared spectra of carbonates (a to c) and phosphates (d to f).

265 1988; Ju et al., 2013; Meza et al., 2014; Green and Buckley, 2014; Fau et al., 2022). But such  
 266 concentration quenching does not seem to occur here since the lifetime of the luminescence signal  
 267 does not change with increasing duration of exposure to UV radiation. The decrease of the Raman  
 268 signal may be due to the radiolysis of chemical bonds or the formation of electronic point defects,  
 269 the accumulation of radiation damages possibly leading to modifications of the chemical composition  
 270 and periodicity of the mineral structure. Note that such a decrease may also be related to the strong  
 271 increase of the background contribution, eventually obscuring the Raman signal.

272 Of note, all initially hydrated starting materials do not show anymore Raman features attributed  
 273 to hydration at the end of the present experiments. Yet, neither Morris and Lauer (1980) nor Yen

274 [et al. \(1999\)](#) observed UV photodehydration, but [Bonales et al. \(2022\)](#) experimentally showed that  
275 exposure to UV enhances the kinetics of dehydration. Dehydration may be a direct consequence  
276 of the simulated Martian conditions. In fact, [Bishop and Pieters \(1995\)](#) showed that minerals may  
277 dehydrate when only exposed to low partial pressure of H<sub>2</sub>O. Here, all the samples investigated have  
278 been exposed to the pressure and temperature conditions of the experiments for 15 hours before  
279 being exposed to UV radiation, and no dehydration was observed during this time. Dehydration  
280 may also result from an increase of the sample surface temperature under exposure to the lamp flux,  
281 as reported by [Morris and Lauer \(1980\)](#) while relying on an IR-rich Xe(A) radiation responsible for  
282 a large increase (> 500°C) of the surface temperature of rather dark samples such as goethite and  
283 lepidocrocite. Yet, the rather low flux generated by the lamp used for the present study (~ 100 times  
284 less intense than that of [Morris and Lauer \(1980\)](#)) and the efficient filtering of radiations > 3 μm of  
285 the fused silica glass window (leading to a dose delivered to the surface of the samples as low as the  
286 dose delivered by the Sun to the surface of Mars) likely prevented thermal dehydration, especially  
287 given that the temperature was regulated during the experiments. In fact, although the temperature  
288 of the chamber and of the sample holder may increase of 20 to 30°C under exposure to the lamp in  
289 the absence of thermal regulation, no such increase was observed during the experiments conducted  
290 under thermal regulation. Rather than indicating the dehydration of the samples initially hydrated,  
291 the total disappearance of the Raman water bands at about 3400 cm<sup>-1</sup> of all the samples initially  
292 hydrated most likely result from the strong increase of the background which eventually masks the  
293 Raman signal over the 3000 to 4000 cm<sup>-1</sup> spectral window. Still, clear differences exist between the  
294 water bands present in the near-IR spectra of the starting materials and those of the samples having  
295 been exposed to UV radiation, suggesting that dehydration, structural alteration, or both did occur  
296 during the experiments. It remains however difficult to directly relate Raman and IR observations  
297 since the volume actually probed by each technique is different. Worse, it is likely that the total  
298 volume of sample actually probed and contributing to the Raman or IR signals collected are different  
299 for the starting materials and for the samples exposed to UV. In fact, although slight, the change  
300 in color of the samples investigated likely reduces their transparency, thus limiting the penetration  
301 of the laser and incident light for IR. A partial structural alteration would also reduce the optical  
302 penetration depth and therefore the contribution of pristine materials to the total signals.

303 Another pending question resides in the volume *in fine* affected by UV itself. During exposure

304 to UV radiation, only the near surface of the samples investigated is penetrated by UV photons  
305 (Fornaro et al., 2018; Fox et al., 2019). However, the actual thickness irradiated can vary from one  
306 sample to another depending on their optical properties, as the volume of sample actually contributing  
307 the Raman and IR signals. Plus, it is very likely that a volume of pristine (non-irradiated) material  
308 contributes to each of the measurements reported here, and that this volume decreases with increasing  
309 duration of exposure to UV as a result of the reduction of the transparency, either due to a color change  
310 or a structural alteration. As a result, it remains difficult to properly quantify the effect of exposure  
311 to UV for the samples investigated here. Both the increase of the background, likely related to the  
312 increasing creation of defects in the irradiated volume, and the decrease of the Raman signal, likely  
313 compensated by the contribution of a volume of pristine material, may be artifactually minimized. The  
314 same is true for IR, although the respective volumes of pristine and irradiated materials contributing  
315 to the signals may be greater thanks to longer wavelength. Properly quantifying the impact of UV  
316 radiation of the spectral signatures of sulfates, phosphates and carbonates would require a dedicated  
317 sample preparation ensuring that the entirety of each sample has been interacted with UV photons.  
318 At that point, a still pending difficulty would be to have a sufficient volume of sample to properly  
319 measure its spectral signature. In any case, it should be kept in mind that although no quantitative  
320 data can be provided here, the experimental setup adopted for the present study mimics pretty well  
321 Martian conditions in terms of UV radiation and signal collection.

### 322 **3.2 Implications for the ongoing exploration of Mars**

323 The present results have strong implications for the ongoing exploration of Mars. In fact, most of the  
324 surface of Mars is continuously exposed to UV radiation, and it has been the case for quite a long  
325 time. Therefore, one should not expect to detect pristine materials, except for measurements on freshly  
326 exposed surfaces, for which the timescale of analysis will be highly critical: the faster after excavation,  
327 the better. Even 24h of irradiation may be enough to impact the Raman and IR spectral signatures of  
328 any target. Therefore, measurements on abraded patches on Mars should be done at latest a Sol after  
329 the abrasion to prevent any radiation-induced modifications of the rocks investigated. As shown here,  
330 the identification of sulfates, phosphates and carbonates can be compromised if they experienced UV  
331 radiation for any given time. Sulfates have been widely detected on the Martian surface, either from  
332 orbit in Valles Marineris, Margaritifer Sinus, and Meridiani Planum (Bishop et al., 2004; Vaniman

333 et al., 2004; Bibring et al., 2005; Gendrin et al., 2005; Lane et al., 2007) or *in situ* by rovers again  
334 in Meridiani Planum, Endeavour Crater and Gale Crater (Squyres et al., 2004a,b; Crumpler et al.,  
335 2015; Rapin et al., 2016), and also at Jezero crater by *Perseverance* (Clavé et al., 2023). A precise  
336 identification of the detected sulfate species has strong implications on their formation conditions (*e.g.*  
337 Rapin et al. 2016). For instance, the detection of bassanite rather than that of anhydrite or gypsum,  
338 will be interpreted as indicating very specific local conditions in particular regarding water salinity  
339 (Rapin et al., 2016). The same is true for phosphates and carbonates (Pollack et al., 1990; Calvin  
340 et al., 1994; Clavé et al., 2023). But, as shown here, the modification of their spectral signatures due  
341 to UV radiation may bias their identification and/or the estimate of their abundances in rocks, which  
342 is directly based on the spectral responses of targets investigated. Similarly, their measured hydration  
343 states may not reflect their true/original hydration state. Because both the abundances and the  
344 hydration states of sulfates, phosphates and carbonates are critical for Martian paleoenvironmental  
345 reconstructions, the effects of exposure to UV have to be taken into account to prevent potentially  
346 significant biases.

347 The present study also highlights that luminescence signals have to be interpreted with special care.  
348 A strong and short-lived luminescence signal resembling the ones collected here on irradiated sulfates,  
349 phosphates and carbonates may easily be misinterpreted as organic fluorescence. In fact, the very short  
350 lifetime of the intrinsic molecular fluorescence of organic compounds (*e.g.*, nanoseconds) compared  
351 to most mineral luminescence (micro- to milliseconds), makes it supposedly pertinent to rely on  
352 luminescence signals to unambiguously identify organics, as done by Scheller et al. (2022b). However,  
353 the short-lived luminescence signals measured here have nothing to do with organics, even though  
354 organics may also exhibit such short-lived luminescence signals after exposure to UV (Megevand et al.,  
355 2021). On Mars, a solution to ensure interpretations could be to repeat any questionable measurement  
356 after a certain time, especially for data collected on freshly excavated surfaces. Obviously, the only  
357 proper way to interpret any data is to do it with caution, knowing that most of the answers will be  
358 provided by the samples which will be brought back to Earth by the upcoming MSR mission.



## 359 4 Conclusion

360 Altogether, although not quantitative, the present results evidence that exposure to UV has a signif-  
361 icant effect on the Raman and IR spectral signatures of sulfates, phosphates and carbonates, which  
362 has, in turn, strong implications for the ongoing exploration of Mars. As a precaution, all the targets  
363 measured on Mars should be considered as having been exposed to UV radiation to some extent.  
364 This will prevent any misinterpretation regarding the nature, abundances and water content of the  
365 mineral phases in presence. Of note, the potential impact of additional processes should also be in-  
366 vestigated and taken into account for the proper interpretation of existing and future data. In fact,  
367 the (sub)surface of Mars is not only exposed to UV radiation, but is also bombarded by gamma-rays,  
368 solar energetic protons and galactic cosmic rays which are not absorbed by the thin CO<sub>2</sub> atmosphere  
369 and may interact with rocks lying at the surface (Kminek and Bada, 2006; Dartnell et al., 2007;  
370 Hassler et al., 2014; Fox et al., 2019). The widespread presence of dust could also generate a strong  
371 background blurring Raman signals (Maurice and Wiens, 2021; Wiens et al., 2021). In addition, a  
372 number of other ageing processes likely act simultaneously at the surface of Mars, including oxidation  
373 (Lasne et al., 2016) and degradation induced by fluid circulation (Viennet et al., 2019), the impact of  
374 these processes on sulfates, phosphates and carbonates (as well as on phyllosilicates and organic com-  
375 pounds) remaining to be constrained to properly reconstruct Martian paleoenvironments and optimize  
376 the search for traces of life on Mars.

## 377 Acknowledgments

378 We acknowledge the support of the IMPMC spectroscopy platform. We acknowledge financial support  
379 from CNRS INP (PI: O. Beyssac), the program Emergences Alliance Sorbonne Université (Project  
380 MarsAtLab PI: S. Bernard), the program Convergence Sorbonne Université (Project Parimicrobial,  
381 PI: K. Benzerara), and from the Institut des Matériaux Sorbonne Université IMat (Project Ageing on  
382 Mars - PI: S. Bernard).

## 383 Competing interests

384 The authors declare that they have no competing interests.

## 385 Open research

386 All the data supporting this study are available upon request.

## 387 References

388 Bartoll, J., Stößer, R., and Nofz, M. (2000). Generation and conversion of electronic defects in calcium  
389 carbonates by UV/Vis light. *Applied Radiation and Isotopes*, 52(5):1099–1105.

390 Ben Mabrouk, K., Kauffmann, T. H., Aroui, H., and Fontana, M. D. (2013). Raman study of cation  
391 effect on sulfate vibration modes in solid state and in aqueous solutions. *Journal of Raman Spec-*  
392 *troscopy*, 44(11):1603–1608.

393 Beyssac, O., Forni, O., Cousin, A., Udry, A., Kah, L., Mandon, L., Clavé, E., Liu, Y., Poulet, F.,  
394 Quantin Nataf, C., Gasnault, O., Johnson, J., Benzerara, K., Beck, P., Dehouck, E., Mangold, N.,  
395 Alvarez Llamas, C., Anderson, R., Arana, G., Barnes, R., Bernard, S., Bosak, T., Brown, A., Castro,  
396 K., Chide, B., Clegg, S., Cloutis, E., Fouchet, T., Gabriel, T., Gupta, S., Lacombe, G., Lasue, J.,  
397 Le Mouelic, S., Lopez-Reyes, G., Madariaga, J., McCubbin, F., McLennan, S., Manrique, J., Meslin,  
398 P., Montmessin, F., Núñez, J., Ollila, A., Ostwald, A., Pilleri, P., Pinet, P., Royer, C., Sharma, S.,  
399 Schröder, S., Simon, J., Toplis, M., Veneranda, M., Willis, P., Maurice, S., Wiens, R., and Team,  
400 T. S. (2023). Petrological traverse of the olivine cumulate Séítah formation at Jezero crater, Mars  
401 : A perspective from SuperCam onboard Perseverance. *Journal of Geophysical Research: Planets*,  
402 n/a(128):e2022JE007638.

403 Bhartia, R., Beegle, L. W., DeFlores, L., Abbey, W., Razzell Hollis, J., Uckert, K., Monacelli, B.,  
404 Edgett, K. S., Kennedy, M. R., Sylvia, M., Aldrich, D., Anderson, M., Asher, S. A., Bailey, Z.,  
405 Boyd, K., Burton, A. S., Caffrey, M., Calaway, M. J., Calvet, R., Cameron, B., Caplinger, M. A.,  
406 Carrier, B. L., Chen, N., Chen, A., Clark, M. J., Clegg, S., Conrad, P. G., Cooper, M., Davis, K. N.,  
407 Ehlmann, B., Facto, L., Fries, M. D., Garrison, D. H., Gasway, D., Ghaemi, F. T., Graff, T. G.,  
408 Hand, K. P., Harris, C., Hein, J. D., Heinz, N., Herzog, H., Hochberg, E., Houck, A., Hug, W. F.,  
409 Jensen, E. H., Kah, L. C., Kennedy, J., Krylo, R., Lam, J., Lindeman, M., McGlowan, J., Michel,  
410 J., Miller, E., Mills, Z., Minitti, M. E., Mok, F., Moore, J., Nealon, K. H., Nelson, A., Newell, R.,  
411 Nixon, B. E., Nordman, D. A., Nuding, D., Orellana, S., Pauken, M., Peterson, G., Pollock, R.,

412 Quinn, H., Quinto, C., Ravine, M. A., Reid, R. D., Riendeau, J., Ross, A. J., Sackos, J., Schaffner,  
413 J. A., Schwochert, M., O Shelton, M., Simon, R., Smith, C. L., Sobron, P., Steadman, K., Steele,  
414 A., Thiessen, D., Tran, V. D., Tsai, T., Tuite, M., Tung, E., Wehbe, R., Weinberg, R., Weiner,  
415 R. H., Wiens, R. C., Williford, K., Wollonciej, C., Wu, Y.-H., Yingst, R. A., and Zan, J. (2021).  
416 Perseverance’s Scanning Habitable Environments with Raman and Luminescence for Organics and  
417 Chemicals (SHERLOC) Investigation. *Space Science Reviews*, 217(4):58.

418 Bibring, J.-P., Hamm, V., Pilorget, C., Vago, J. L., and the MicrOmega Team (2017). The MicrOmega  
419 Investigation Onboard ExoMars. *Astrobiology*, 17(6-7):621–626.

420 Bibring, J.-P., Langevin, Y., Gendrin, A., Gondet, B., Poulet, F., Berthe, M., Soufflot, A., Arvidson,  
421 R., Mangold, N., Mustard, J., Drossart, P., Team, O., Erard, S., Forni, O., Combes, M., Encrenaz,  
422 T., Fouchet, T., Merchiorri, R., Belluci, G., Altieri, F., Formisano, V., Bonello, G., Capaccioni, F.,  
423 Cerroni, P., Coradini, A., Fonti, S., Kottsov, V., Ignatiev, N., Moroz, V., Titov, D., Zasova, L.,  
424 Mangold, M., Pinet, P., Doute, S., Schmitt, B., Sotin, C., Hauber, E., Hoffmann, H., Jaumann,  
425 R., Keller, U., Duxbury, T., and Forget, F. (2005). Mars Surface Diversity as Revealed by the  
426 OMEGA/Mars Express Observations. *Science*, 307(5715):1576.

427 Bish, D. L., William Carey, J., Vaniman, D. T., and Chipera, S. J. (2003). Stability of hydrous  
428 minerals on the martian surface. *Icarus*, 164:96–103.

429 Bishop, J. L., Darby Dyar, M., Lane, M. D., and Banfield, J. F. (2004). Spectral identification of  
430 hydrated sulfates on Mars and comparison with acidic environments on Earth. *International Journal*  
431 *of Astrobiology*, 3:275–285.

432 Bishop, J. L. and Pieters, C. M. (1995). Low-temperature and low atmospheric pressure infrared  
433 reflectance spectroscopy of Mars soil analog materials. *Journal of Geophysical Research*, 100:5369–  
434 5380.

435 Bonales, L. J., Rodríguez-Villagra, N., Fernandez-Sampedro, M., and Mateo-Martí, E. (2022). De-  
436 hydration rate of the glycine-MgSO<sub>4</sub> · 5H<sub>2</sub>O complex and the stability of glycine expelled from  
437 the complex by in situ Raman spectroscopy under Mars-relevant conditions. *Journal of Raman*  
438 *Spectroscopy*, 53:724–734.

- 439 Buzgar, N., Buzatu, A., and Sanislav, I. V. (2009). The Raman Study of Certain Sulfates. *Analele*  
440 *Stiintifice Ale Universitatii „AL. I. CUZA” Iasi*, 55(1):19.
- 441 Calvin, W. M., King, T. V. V., and Clark, R. N. (1994). Hydrous carbonates on Mars?: Evidence  
442 from Mariner 6/7 infrared spectrometer and ground-based telescopic spectra. *Journal of Geophysical*  
443 *Research*, 99:14659–14676.
- 444 Carrier, B. L., Abbey, W. J., Beegle, L. W., Bhartia, R., and Liu, Y. (2019). Attenuation of Ultraviolet  
445 Radiation in Rocks and Minerals: Implications for Mars Science. *Journal of Geophysical Research:*  
446 *Planets*, 124(10):2599–2612.
- 447 Carter, J., Poulet, F., Bibring, J.-P., and Murchie, S. (2010). Detection of Hydrated Silicates in  
448 Crustal Outcrops in the Northern Plains of Mars. *Science*, 328(5986):1682–1686.
- 449 Chen, R. F. and Knutson, J. R. (1988). Mechanism of fluorescence concentration quenching of car-  
450 boxylfluorescein in liposomes: Energy transfer to nonfluorescent dimers. *Analytical Biochemistry*,  
451 172(1):61–77.
- 452 Clavé, E., Benzerara, K., Meslin, P.-Y., Forni, O., Royer, C., Mandon, L., Beck, P., Quantin-Nataf,  
453 C., Beyssac, O., Cousin, A., Bousquet, B., Wiens, R., Maurice, S., Dehouck, E., Schröder, S.,  
454 Gasnault, O., Mangold, N., Dromart, G., Bosak, T., Bernard, S., Udry, A., Anderson, R., Arana,  
455 G., Brown, A., Castro, K., Clegg, S., Cloutis, E., Fairén, A., Flannery, D., Gasda, P., Johnson,  
456 J., Lasue, J., Lopez-Reyes, G., Madariaga, J., Manrique, J., Le Mouélic, S., Núñez, J., Ollila, A.,  
457 Pilleri, P., Pilorget, C., Pinet, P., Poulet, F., Veneranda, M., Wolf, Z., and Team, t. S. (2023).  
458 Carbonate Detection with SuperCam in Igneous Rocks on the floor of Jezero Crater, Mars. *Journal*  
459 *of Geophysical Research: Planets*, 128(1).
- 460 Cloutis, E. A., Craig, M. A., Kruzelecky, R. V., Jamroz, W. R., Scott, A., Hawthorne, F. C., and  
461 Mertzman, S. A. (2008). Spectral reflectance properties of minerals exposed to simulated Mars  
462 surface conditions. *Icarus*, 195(1):140–168.
- 463 Cloutis, E. A., Craig, M. A., Mustard, J. F., Kruzelecky, R. V., Jamroz, W. R., Scott, A., Bish,  
464 D. L., Poulet, F., Bibring, J.-P., and King, P. L. (2007). Stability of hydrated minerals on Mars.  
465 *Geophysical Research Letters*, 34(20).

466 Crumpler, L. S., Arvidson, R. E., Bell, J., Clark, B. C., Cohen, B. A., Farrand, W. H., Gellert, R.,  
467 Golombek, M., Grant, J. A., Guinness, E., Herkenhoff, K. E., Johnson, J. R., Jolliff, B., Ming, D. W.,  
468 Mittlefehldt, D. W., Parker, T., Rice, J. W., Squyres, S. W., Sullivan, R., and Yen, A. S. (2015).  
469 Context of ancient aqueous environments on Mars from in situ geologic mapping at Endeavour  
470 Crater. *Journal of Geophysical Research: Planets*, 120(3):538–569.

471 Dartnell, L. R., Desorgher, L., Ward, J. M., and Coates, A. J. (2007). Modelling the surface and  
472 subsurface Martian radiation environment: Implications for astrobiology. *Geophysical Research*  
473 *Letters*, 34(2).

474 Ehlmann, B. L., Mustard, J. F., Murchie, S. L., Bibring, J.-P., Meunier, A., Fraeman, A. A., and  
475 Langevin, Y. (2011). Subsurface water and clay mineral formation during the early history of Mars.  
476 *Nature*, 479(7371):53–60.

477 Farley, K. A., Williford, K. H., Stack, K. M., Bhartia, R., Chen, A., de la Torre, M., Hand, K., Goreva,  
478 Y., Herd, C. D. K., Hueso, R., Liu, Y., Maki, J. N., Martinez, G., Moeller, R. C., Nelessen, A.,  
479 Newman, C. E., Nunes, D., Ponce, A., Spanovich, N., Willis, P. A., Beegle, L. W., Bell, J. F., Brown,  
480 A. J., Hamran, S.-E., Hurowitz, J. A., Maurice, S., Paige, D. A., Rodriguez-Manfredi, J. A., Schulte,  
481 M., and Wiens, R. C. (2020). Mars 2020 Mission Overview. *Space Science Reviews*, 216(8):142.

482 Fau, A., Beyssac, O., Gauthier, M., Meslin, P. Y., Cousin, A., Benzerara, K., Bernard, S., Boulliard,  
483 J. C., Gasnault, O., Forni, O., Wiens, R. C., Morand, M., Rosier, P., Garino, Y., Pont, S., and  
484 Maurice, S. (2019). Pulsed laser-induced heating of mineral phases: Implications for laser-induced  
485 breakdown spectroscopy combined with Raman spectroscopy. *Spectrochimica Acta Part B: Atomic*  
486 *Spectroscopy*, 160:105687.

487 Fau, A., Beyssac, O., Gauthier, M., Panczer, G., Gasnault, O., Meslin, P.-Y., Bernard, S., Maurice, S.,  
488 Forni, O., Boulliard, J.-C., Bosc, F., and Drouet, C. (2022). Time-resolved Raman and luminescence  
489 spectroscopy of synthetic REE-doped hydroxylapatites and natural apatites. *American Mineralogist*,  
490 107:1341–1352.

491 Fornaro, T., Boosman, A., Brucato, J. R., ten Kate, I. L., Siljeström, S., Poggiali, G., Steele, A.,  
492 and Hazen, R. M. (2018). UV irradiation of biomarkers adsorbed on minerals under Martian-like  
493 conditions: Hints for life detection on Mars. *Icarus*, 313:38–60.

494 Fouchet, T., Reess, J.-M., Montmessin, F., Hassen-Khodja, R., Nguyen-Tuong, N., Humeau, O.,  
495 Jacquino, S., Lapauw, L., Parisot, J., Bonafous, M., Bernardi, P., Chapron, F., Jeanneau, A.,  
496 Collin, C., Zeganadin, D., Nibert, P., Abbaki, S., Montaron, C., Blanchard, C., Arslanyan, V.,  
497 Achelhi, O., Colon, C., Royer, C., Hamm, V., Beuzit, M., Poulet, F., Pilorget, C., Mandon, L., Forni,  
498 O., Cousin, A., Gasnault, O., Pilleri, P., Dubois, B., Quantin, C., Beck, P., Beyssac, O., Le Mouélic,  
499 S., Johnsson, J. R., McConnochie, T. H., Maurice, S., and Wiens, R. C. (2022). The SuperCam  
500 infrared spectrometer for the perseverance rover of the Mars2020 mission. *Icarus*, 373:114773.

501 Fourdrin, C., Balan, E., Allard, T., Boukari, C., and Calas, G. (2009). Induced modifications of  
502 kaolinite under ionizing radiation: An infrared spectroscopic study. *Physics and Chemistry of*  
503 *Minerals*, 36:291–299.

504 Fox, A. C., Eigenbrode, J. L., and Freeman, K. H. (2019). Radiolysis of Macromolecular Organic Ma-  
505 terial in Mars-Relevant Mineral Matrices. *Journal of Geophysical Research: Planets*, 124(12):3257–  
506 3266.

507 Gendrin, A., Mangold, N., Bibring, J.-P., Langevin, Y., Gondet, B., Poulet, F., Bonello, G., Quantin,  
508 C., Mustard, J., Arvidson, R., and LeMouélic, S. (2005). Sulfates in Martian Layered Terrains: The  
509 OMEGA/Mars Express View. *Science*, 307(5715):1587–1591.

510 Green, A. P. and Buckley, A. R. (2014). Solid state concentration quenching of organic fluorophores in  
511 PMMA. *Physical Chemistry Chemical Physics (Incorporating Faraday Transactions)*, 17:1435–1440.

512 Grotzinger, J. P., Sumner, D. Y., Kah, L. C., Stack, K., Gupta, S., Edgar, L., Rubin, D., Lewis, K.,  
513 Schieber, J., Mangold, N., Milliken, R., Conrad, P. G., DesMarais, D., Farmer, J., Siebach, K.,  
514 Calef, F., Hurowitz, J., McLennan, S. M., Ming, D., Vaniman, D., Crisp, J., Vasavada, A., Edgett,  
515 K. S., Malin, M., Blake, D., Gellert, R., Mahaffy, P., Wiens, R. C., Maurice, S., Grant, J. A.,  
516 Wilson, S., Anderson, R. C., Beegle, L., Arvidson, R., Hallet, B., Sletten, R. S., Rice, M., Bell, J.,  
517 Griffes, J., Ehlmann, B., Anderson, R. B., Bristow, T. F., Dietrich, W. E., Dromart, G., Eigenbrode,  
518 J., Fraeman, A., Hardgrove, C., Herkenhoff, K., Jandura, L., Kocurek, G., Lee, S., Leshin, L. A.,  
519 Leveille, R., Limonadi, D., Maki, J., McCloskey, S., Meyer, M., Minitti, M., Newsom, H., Oehler,  
520 D., Okon, A., Palucis, M., Parker, T., Rowland, S., Schmidt, M., Squyres, S., Steele, A., Stolper,  
521 E., Summons, R., Treiman, A., Williams, R., Yingst, A., Team, M. S., Kemppinen, O., Bridges,

522 N., Johnson, J. R., Cremers, D., Godber, A., Wadhwa, M., Wellington, D., McEwan, I., Newman,  
523 C., Richardson, M., Charpentier, A., Peret, L., King, P., Blank, J., Weigle, G., Li, S., Robertson,  
524 K., Sun, V., Baker, M., Edwards, C., Farley, K., Miller, H., Newcombe, M., Pilorget, C., Brunet,  
525 C., Hipkin, V., Léveillé, R., Marchand, G., Sánchez, P. S., Favot, L., Cody, G., Flückiger, L., Lees,  
526 D., Nefian, A., Martin, M., Gailhanou, M., Westall, F., Israël, G., Agard, C., Baroukh, J., Donny,  
527 C., Gaboriaud, A., Guillemot, P., Lafaille, V., Lorigny, E., Paillet, A., Pérez, R., Saccoccio, M.,  
528 Yana, C., Armien-Aparicio, C., Rodríguez, J. C., Blázquez, I. C., Gómez, F. G., Gómez-Elvira, J.,  
529 Hettrich, S., Malvitte, A. L., Jiménez, M. M., Martínez-Frías, J., Martín-Soler, J., Martín-Torres,  
530 F. J., Jurado, A. M., Mora-Sotomayor, L., Caro, G. M., López, S. N., Peinado-González, V., Pla-  
531 García, J., Manfredi, J. A. R., Romeral-Planelló, J. J., Fuentes, S. A. S., Martinez, E. S., Redondo,  
532 J. T., Urqui-O'Callaghan, R., Mier, M.-P. Z., Chipera, S., Lacour, J.-L., Mauchien, P., Sirven, J.-B.,  
533 Manning, H., Fairén, A., Hayes, A., Joseph, J., Sullivan, R., Thomas, P., Dupont, A., Lundberg,  
534 A., Melikechi, N., Mezzacappa, A., DeMarines, J., Grinspoon, D., Reitz, G., Prats, B., Atlaskin, E.,  
535 Genzer, M., Harri, A.-M., Haukka, H., Kahanpää, H., Kauhanen, J., Paton, M., Polkko, J., Schmidt,  
536 W., Siili, T., Fabre, C., Wray, J., Wilhelm, M. B., Poitrasson, F., Patel, K., Gorevan, S., Indyk, S.,  
537 Paulsen, G., Bish, D., Gondet, B., Langevin, Y., Geffroy, C., Baratoux, D., Berger, G., Cros, A.,  
538 d'Uston, C., Forni, O., Gasnault, O., Lasue, J., Lee, Q.-M., Meslin, P.-Y., Pallier, E., Parot, Y.,  
539 Pinet, P., Schröder, S., Toplis, M., Lewin, É., Brunner, W., Heydari, E., Achilles, C., Sutter, B.,  
540 Cabane, M., Coscia, D., Szopa, C., Robert, F., Sautter, V., Le Mouélic, S., Nachon, M., Buch, A.,  
541 Stalport, F., Coll, P., François, P., Raulin, F., Teinturier, S., Cameron, J., Clegg, S., Cousin, A.,  
542 DeLapp, D., Dingler, R., Jackson, R. S., Johnstone, S., Lanza, N., Little, C., Nelson, T., Williams,  
543 R. B., Jones, A., Kirkland, L., Baker, B., Cantor, B., Caplinger, M., Davis, S., Duston, B., Fay,  
544 D., Harker, D., Herrera, P., Jensen, E., Kennedy, M. R., Krezoski, G., Krysak, D., Lipkaman, L.,  
545 McCartney, E., McNair, S., Nixon, B., Posiolova, L., Ravine, M., Salamon, A., Saper, L., Stoiber,  
546 K., Supulver, K., Van Beek, J., Van Beek, T., Zimdar, R., French, K. L., Iagnemma, K., Miller,  
547 K., Goesmann, F., Goetz, W., Hviid, S., Johnson, M., Lefavor, M., Lyness, E., Breves, E., Dyar,  
548 M. D., Fassett, C., Edwards, L., Haberle, R., Hoehler, T., Hollingsworth, J., Kahre, M., Keely,  
549 L., McKay, C., Bleacher, L., Brinckerhoff, W., Choi, D., Dworkin, J. P., Floyd, M., Freissinet, C.,  
550 Garvin, J., Glavin, D., Harpold, D., Martin, D. K., McAdam, A., Pavlov, A., Raaen, E., Smith,  
551 M. D., Stern, J., Tan, F., Trainer, M., Posner, A., Voytek, M., Aubrey, A., Behar, A., Blaney, D.,



552 Brinza, D., Christensen, L., DeFlores, L., Feldman, J., Feldman, S., Flesch, G., Jun, I., Keymeulen,  
553 D., Mischna, M., Morookian, J. M., Pavri, B., Schoppers, M., Sengstacken, A., Simmonds, J. J.,  
554 Spanovich, N., Juarez, M. d. l. T., Webster, C. R., Yen, A., Archer, P. D., Cucinotta, F., Jones, J. H.,  
555 Morris, R. V., Niles, P., Rampe, E., Nolan, T., Fisk, M., Radziemski, L., Barraclough, B., Bender,  
556 S., Berman, D., Dobrea, E. N., Tokar, R., Cleghorn, T., Huntress, W., Manhès, G., Hudgins, J.,  
557 Olson, T., Stewart, N., Sarrazin, P., Vicenzi, E., Bullock, M., Ehresmann, B., Hamilton, V., Hassler,  
558 D., Peterson, J., Rafkin, S., Zeitlin, C., Fedosov, F., Golovin, D., Karpushkina, N., Kozyrev, A.,  
559 Litvak, M., Malakhov, A., Mitrofanov, I., Mokrousov, M., Nikiforov, S., Prokhorov, V., Sanin,  
560 A., Tretyakov, V., Varenikov, A., Vostrukhin, A., Kuzmin, R., Clark, B., Wolff, M., Botta, O.,  
561 Drake, D., Bean, K., Lemmon, M., Schwenzer, S. P., Lee, E. M., Sucharski, R., Hernández, M. Á.  
562 d. P., Ávalos, J. J. B., Ramos, M., Kim, M.-H., Malespin, C., Plante, I., Muller, J.-P., Navarro-  
563 González, R., Ewing, R., Boynton, W., Downs, R., Fitzgibbon, M., Harshman, K., Morrison, S.,  
564 Kortmann, O., Williams, A., Lugmair, G., Wilson, M. A., Jakosky, B., Balic-Zunic, T., Frydenvang,  
565 J., Jensen, J. K., Kinch, K., Koefoed, A., Madsen, M. B., Stipp, S. L. S., Boyd, N., Campbell, J. L.,  
566 Perrett, G., Pradler, I., VanBommel, S., Jacob, S., Owen, T., Savijärvi, H., Boehm, E., Böttcher, S.,  
567 Burmeister, S., Guo, J., Köhler, J., García, C. M., Mueller-Mellin, R., Wimmer-Schweingruber, R.,  
568 Bridges, J. C., McConnochie, T., Benna, M., Franz, H., Bower, H., Brunner, A., Blau, H., Boucher,  
569 T., Carosino, M., Atreya, S., Elliott, H., Halleaux, D., Rennó, N., Wong, M., Pepin, R., Elliott,  
570 B., Spray, J., Thompson, L., Gordon, S., Ollila, A., Williams, J., Vasconcelos, P., Bentz, J., Nealson,  
571 K., Popa, R., Moersch, J., Tate, C., Day, M., Francis, R., McCullough, E., Cloutis, E., ten Kate,  
572 I. L., Scholes, D., Slavney, S., Stein, T., Ward, J., Berger, J., and Moores, J. E. (2014). A Habitable  
573 Fluvio-Lacustrine Environment at Yellowknife Bay, Gale Crater, Mars. *Science*, 343(6169):1242777.

574 Gunasekaran, S., Anbalagan, G., and Pandi, S. (2006). Raman and infrared spectra of carbonates of  
575 calcite structure. *Journal of Raman Spectroscopy*, 37(9):892–899.

576 Harner, P. L. and Gilmore, M. S. (2015). Visible–near infrared spectra of hydrous carbonates, with  
577 implications for the detection of carbonates in hyperspectral data of Mars. *Icarus*, 250:204–214.

578 Hassler, D. M., Zeitlin, C., Wimmer-Schweingruber, R. F., Ehresmann, B., Rafkin, S., Eigenbrode,  
579 J. L., Brinza, D. E., Weigle, G., Böttcher, S., Böhm, E., Burmeister, S., Guo, J., Köhler, J.,  
580 Martin, C., Reitz, G., Cucinotta, F. A., Kim, M.-H., Grinspoon, D., Bullock, M. A., Posner, A.,

581 Gómez-Elvira, J., Vasavada, A., Grotzinger, J. P., Team, M. S., Kempainen, O., Cremers, D., Bell,  
582 J. F., Edgar, L., Farmer, J., Godber, A., Wadhwa, M., Wellington, D., McEwan, I., Newman, C.,  
583 Richardson, M., Charpentier, A., Peret, L., King, P., Blank, J., Schmidt, M., Li, S., Milliken, R.,  
584 Robertson, K., Sun, V., Baker, M., Edwards, C., Ehlmann, B., Farley, K., Griffes, J., Miller, H.,  
585 Newcombe, M., Pilorget, C., Rice, M., Siebach, K., Stack, K., Stolper, E., Brunet, C., Hipkin, V.,  
586 Léveill e, R., Marchand, G., S anchez, P. S., Favot, L., Cody, G., Steele, A., Fl uckiger, L., Lees, D.,  
587 Nefian, A., Martin, M., Gailhanou, M., Westall, F., Isra el, G., Agard, C., Baroukh, J., Donny, C.,  
588 Gaboriaud, A., Guillemot, P., Lafaille, V., Lorigny, E., Paillet, A., P erez, R., Saccoccio, M., Yana,  
589 C., Armien-Aparicio, C., Rodr iguez, J. C., Bl azquez, I. C., G omez, F. G., Hettrich, S., Malvitte,  
590 A. L., Jim enez, M. M., Mart inez-Fr ias, J., Mart ın-Soler, J., Mart ın-Torres, F. J., Jurado, A. M.,  
591 Mora-Sotomayor, L., Caro, G. M., L opez, S. N., Peinado-Gonz alez, V., Pla-Garc ıa, J., Manfredi, J.  
592 A. R., Romeral-Planell o, J. J., Fuentes, S. A. S., Martinez, E. S., Redondo, J. T., Urqui-O’Callaghan,  
593 R., Mier, M.-P. Z., Chipera, S., Lacour, J.-L., Mauchien, P., Sirven, J.-B., Manning, H., Fair en, A.,  
594 Hayes, A., Joseph, J., Squyres, S., Sullivan, R., Thomas, P., Dupont, A., Lundberg, A., Melikechi,  
595 N., Mezzacappa, A., Berger, T., Matthia, D., Prats, B., Atlaskin, E., Genzer, M., Harri, A.-M.,  
596 Haukka, H., Kahanp a , H., Kauhanen, J., Kempainen, O., Paton, M., Polkko, J., Schmidt, W.,  
597 Siili, T., Fabre, C., Wray, J., Wilhelm, M. B., Poitrasson, F., Patel, K., Gorevan, S., Indyk, S.,  
598 Paulsen, G., Gupta, S., Bish, D., Schieber, J., Gondet, B., Langevin, Y., Geffroy, C., Baratoux,  
599 D., Berger, G., Cros, A., d’Uston, C., Forni, O., Gasnault, O., Lasue, J., Lee, Q.-M., Maurice,  
600 S., Meslin, P.-Y., Pallier, E., Parot, Y., Pinet, P., Schr oder, S., Toplis, M., Lewin,  . E., Brunner,  
601 W., Heydari, E., Achilles, C., Oehler, D., Sutter, B., Cabane, M., Coscia, D., Isra el, G., Szopa,  
602 C., Dromart, G., Robert, F., Sautter, V., Le Mou elic, S., Mangold, N., Nachon, M., Buch, A.,  
603 Stalport, F., Coll, P., Fran ois, P., Raulin, F., Teinturier, S., Cameron, J., Clegg, S., Cousin, A.,  
604 DeLapp, D., Dingler, R., Jackson, R. S., Johnstone, S., Lanza, N., Little, C., Nelson, T., Wiens,  
605 R. C., Williams, R. B., Jones, A., Kirkland, L., Treiman, A., Baker, B., Cantor, B., Caplinger,  
606 M., Davis, S., Duston, B., Edgett, K., Fay, D., Hardgrove, C., Harker, D., Herrera, P., Jensen, E.,  
607 Kennedy, M. R., Krezoski, G., Krysak, D., Lipkaman, L., Malin, M., McCartney, E., McNair, S.,  
608 Nixon, B., Posiolova, L., Ravine, M., Salamon, A., Saper, L., Stoiber, K., Supulver, K., Van Beek,  
609 J., Van Beek, T., Zimdar, R., French, K. L., Iagnemma, K., Miller, K., Summons, R., Goesmann,  
610 F., Goetz, W., Hviid, S., Johnson, M., Lefavor, M., Lyness, E., Breves, E., Dyar, M. D., Fassett,

611 C., Blake, D. F., Bristow, T., DesMarais, D., Edwards, L., Haberle, R., Hoehler, T., Hollingsworth,  
612 J., Kahre, M., Keely, L., McKay, C., Wilhelm, M. B., Bleacher, L., Brinckerhoff, W., Choi, D.,  
613 Conrad, P., Dworkin, J. P., Floyd, M., Freissinet, C., Garvin, J., Glavin, D., Harpold, D., Jones, A.,  
614 Mahaffy, P., Martin, D. K., McAdam, A., Pavlov, A., Raaen, E., Smith, M. D., Stern, J., Tan, F.,  
615 Trainer, M., Meyer, M., Voytek, M., Anderson, R. C., Aubrey, A., Beegle, L. W., Behar, A., Blaney,  
616 D., Calef, F., Christensen, L., Crisp, J. A., DeFlores, L., Ehlmann, B., Feldman, J., Feldman, S.,  
617 Flesch, G., Hurowitz, J., Jun, I., Keymeulen, D., Maki, J., Mischna, M., Morookian, J. M., Parker,  
618 T., Pavri, B., Schoppers, M., Sengstacken, A., Simmonds, J. J., Spanovich, N., Juarez, M. d. l. T.,  
619 Webster, C. R., Yen, A., Archer, P. D., Jones, J. H., Ming, D., Morris, R. V., Niles, P., Rampe, E.,  
620 Nolan, T., Fisk, M., Radziemski, L., Barraclough, B., Bender, S., Berman, D., Dobrea, E. N., Tokar,  
621 R., Vaniman, D., Williams, R. M. E., Yingst, A., Lewis, K., Leshin, L., Cleghorn, T., Huntress, W.,  
622 Manhès, G., Hudgins, J., Olson, T., Stewart, N., Sarrazin, P., Grant, J., Vicenzi, E., Wilson, S. A.,  
623 Hamilton, V., Peterson, J., Fedosov, F., Golovin, D., Karpushkina, N., Kozyrev, A., Litvak, M.,  
624 Malakhov, A., Mitrofanov, I., Mokrousov, M., Nikiforov, S., Prokhorov, V., Sanin, A., Tretyakov,  
625 V., Varenikov, A., Vostrukhin, A., Kuzmin, R., Clark, B., Wolff, M., McLennan, S., Botta, O.,  
626 Drake, D., Bean, K., Lemmon, M., Schwenzer, S. P., Anderson, R. B., Herkenhoff, K., Lee, E. M.,  
627 Sucharski, R., Hernández, M. Á. d. P., Ávalos, J. J. B., Ramos, M., Malespin, C., Plante, I., Muller,  
628 J.-P., Navarro-González, R., Ewing, R., Boynton, W., Downs, R., Fitzgibbon, M., Harshman, K.,  
629 Morrison, S., Dietrich, W., Kortmann, O., Palucis, M., Sumner, D. Y., Williams, A., Lugmair, G.,  
630 Wilson, M. A., Rubin, D., Jakosky, B., Balic-Zunic, T., Frydenvang, J., Jensen, J. K., Kinch, K.,  
631 Koefoed, A., Madsen, M. B., Stipp, S. L. S., Boyd, N., Campbell, J. L., Gellert, R., Perrett, G.,  
632 Pradler, I., VanBommel, S., Jacob, S., Owen, T., Rowland, S., Atlaskin, E., Savijärvi, H., García,  
633 C. M., Mueller-Mellin, R., Bridges, J. C., McConnochie, T., Benna, M., Franz, H., Bower, H.,  
634 Brunner, A., Blau, H., Boucher, T., Carosino, M., Atreya, S., Elliott, H., Halleaux, D., Rennó,  
635 N., Wong, M., Pepin, R., Elliott, B., Spray, J., Thompson, L., Gordon, S., Newsom, H., Ollila, A.,  
636 Williams, J., Vasconcelos, P., Bentz, J., Neelson, K., Popa, R., Kah, L. C., Moersch, J., Tate, C.,  
637 Day, M., Kocurek, G., Hallet, B., Sletten, R., Francis, R., McCullough, E., Cloutis, E., ten Kate,  
638 I. L., Kuzmin, R., Arvidson, R., Fraeman, A., Scholes, D., Slavney, S., Stein, T., Ward, J., Berger,  
639 J., and Moores, J. E. (2014). Mars' Surface Radiation Environment Measured with the Mars Science  
640 Laboratory's Curiosity Rover. *Science*, 343(6169):1244797.

- 641 Ju, G., Hu, Y., Chen, L., Wang, X., and Mu, Z. (2013). Concentration quenching of persistent  
642 luminescence. *Physica B: Condensed Matter*, 415:1–4.
- 643 Kabacińska, Z., Krzymiński, R., Tadyszak, K., and Coy, E. (2019). Generation of UV-induced  
644 radiation defects in calcite. *Quaternary Geochronology*, 51:24–42.
- 645 Kabacińska, Z., Yate, L., Wencka, M., Krzymiński, R., Tadyszak, K., and Coy, E. (2017). Nanoscale  
646 Effects of Radiation (UV, X-ray, and  $\gamma$ ) on Calcite Surfaces: Implications for its Mechanical and  
647 Physico-Chemical Properties. *The Journal of Physical Chemistry C*, 121(24):13357–13369.
- 648 Kminek, G. and Bada, J. L. (2006). The effect of ionizing radiation on the preservation of amino acids  
649 on Mars. *Earth and Planetary Science Letters*, 245(1):1–5.
- 650 Korablev, O., Montmessin, F., Trokhimovskiy, A., Fedorova, A. A., Shakun, A. V., Grigoriev, A. V.,  
651 Moshkin, B. E., Ignatiev, N. I., Forget, F., Lefèvre, F., Anufreychik, K., Dzuban, I., Ivanov, Y. S.,  
652 Kalinnikov, Y. K., Kozlova, T. O., Kungurov, A., Makarov, V., Martynovich, F., Maslov, I., Mer-  
653 zlyakov, D., Moiseev, P. P., Nikolskiy, Y., Patrakeev, A., Patsaev, D., Santos-Skripko, A., Sazonov,  
654 O., Semena, N., Semenov, A., Shashkin, V., Sidorov, A., Stepanov, A. V., Stupin, I., Timonin, D.,  
655 Titov, A. Y., Viktorov, A., Zharkov, A., Altieri, F., Arnold, G., Belyaev, D. A., Bertaux, J. L., Bet-  
656 sis, D. S., Duxbury, N., Encrenaz, T., Fouchet, T., Gérard, J.-C., Grassi, D., Guerlet, S., Hartogh,  
657 P., Kasaba, Y., Khatuntsev, I., Krasnopolsky, V. A., Kuzmin, R. O., Lellouch, E., Lopez-Valverde,  
658 M. A., Luginin, M., Määttänen, A., Marcq, E., Martin Torres, J., Medvedev, A. S., Millour, E.,  
659 Olsen, K. S., Patel, M. R., Quantin-Nataf, C., Rodin, A. V., Shematovich, V. I., Thomas, I.,  
660 Thomas, N., Vazquez, L., Vincendon, M., Wilquet, V., Wilson, C. F., Zasova, L. V., Zelenyi, L. M.,  
661 and Zorzano, M. P. (2017). The Atmospheric Chemistry Suite (ACS) of Three Spectrometers for  
662 the ExoMars 2016 Trace Gas Orbiter. *Space Science Reviews*, 214(1):7.
- 663 Lane, M. D., Bishop, J. L., Dyar, M. D., Parente, M., King, P. L., and Hyde, B. C. (2007). Identifying  
664 the Phosphate and Ferric Sulfate Minerals in the Paso Robles Soils (Gusev Crater, Mars) Using an  
665 Integrated Spectral Approach. *38th Lunar and Planetary Science Conference*, page 2176.
- 666 Lasne, J., Noblet, A., Szopa, C., Navarro-González, R., Cabane, M., Poch, O., Stalport, F., François,  
667 P., Atreya, S., and Coll, P. (2016). Oxidants at the Surface of Mars: A Review in Light of Recent  
668 Exploration Results. *Astrobiology*, 16(12):977–996.

669 Manrique, J. A., Lopez-Reyes, G., Cousin, A., Rull, F., Maurice, S., Wiens, R. C., Madsen, M. B.,  
670 Madariaga, J. M., Gasnault, O., Aramendia, J., Arana, G., Beck, P., Bernard, S., Bernardi, P.,  
671 Bernt, M. H., Berrocal, A., Beyssac, O., Caïs, P., Castro, C., Castro, K., Clegg, S. M., Cloutis, E.,  
672 Dromart, G., Drouet, C., Dubois, B., Escribano, D., Fabre, C., Fernandez, A., Forni, O., Garcia-  
673 Baonza, V., Gontijo, I., Johnson, J., Laserna, J., Lasue, J., Madsen, S., Mateo-Marti, E., Medina,  
674 J., Meslin, P.-Y., Montagnac, G., Moral, A., Moros, J., Ollila, A. M., Ortega, C., Prieto-Ballesteros,  
675 O., Reess, J. M., Robinson, S., Rodriguez, J., Saiz, J., Sanz-Arranz, J. A., Sard, I., Sautter, V.,  
676 Sobron, P., Toplis, M., and Veneranda, M. (2020). SuperCam Calibration Targets: Design and  
677 Development. *Space Science Reviews*, 216(8):138.

678 Maurice, S. A. and Wiens, R. C. (2021). Mars 2020 SuperCam Bundle.

679 McMahon, S., Bosak, T., Grotzinger, J. P., Milliken, R. E., Summons, R. E., Daye, M., Newman,  
680 S. A., Fraeman, A., Williford, K. H., and Briggs, D. E. G. (2018). A Field Guide to Finding Fossils  
681 on Mars. *Journal of Geophysical Research (Planets)*, 123:1012–1040.

682 Megevand, V., Viennet, J., Balan, E., Gauthier, M., Rosier, P., Morand, M., Garino, Y., Guillaumet,  
683 M., Pont, S., Beyssac, O., and Bernard, S. (2021). Impact of UV Radiation on the Raman Signal  
684 of Cystine: Implications for the Detection of S-rich Organics on Mars. *Astrobiology*, 21(5):566–574.

685 Meyer, M. A., Kminek, G., Beaty, D. W., Carrier, B. L., Haltigin, T., Hays, L. E., Agree, C. B.,  
686 Busemann, H., Cavalazzi, B., Cockell, C. S., Debaille, V., Glavin, D. P., Grady, M. M., Hauber,  
687 E., Hutzler, A., Marty, B., McCubbin, F. M., Pratt, L. M., Regberg, A. B., Smith, A. L., Smith,  
688 C. L., Summons, R. E., Swindle, T. D., Tait, K. T., Tosca, N. J., Udry, A., Usui, T., Velbel, M. A.,  
689 Wadhwa, M., Westall, F., and Zorzano, M.-P. (2022). Final Report of the Mars Sample Return  
690 Science Planning Group 2 (MSPG2). *Astrobiology*, 22(S1):S–5.

691 Meza, O., Villabona-Leal, E. G., Diaz-Torres, L. A., Desirena, H., Rodríguez-López, J. L., and Pérez,  
692 E. (2014). Luminescence Concentration Quenching Mechanism in Gd<sub>2</sub>O<sub>3</sub>:Eu<sup>3+</sup>. *The Journal of*  
693 *Physical Chemistry A*, 118(8):1390–1396.

694 Moeller, R. C., Jandura, L., Rosette, K., Robinson, M., Samuels, J., Silverman, M., Brown, K., Duffy,  
695 E., Yazzie, A., Jens, E., Brockie, I., White, L., Goreva, Y., Zorn, T., Okon, A., Lin, J., Frost,  
696 M., Collins, C., Williams, J. B., Steltzner, A., Chen, F., and Biesiadecki, J. (2020). The Sampling

697 and Caching Subsystem (SCS) for the Scientific Exploration of Jezero Crater by the Mars 2020  
698 Perseverance Rover. *Space Science Reviews*, 217(1):5.

699 Morris, R. V. and Lauer, H. V. (1980). The case against UV photostimulated oxidation of magnetite.  
700 *Geophysical Research Letters*, 7(8):605–608.

701 Mukhin, L. M., Koscheevi, A. P., Dikov, Yu. P., Huth, J., and Wänke, H. (1996). Experimental  
702 simulations of the photodecomposition of carbonates and sulphates on Mars. *Nature*, 379:141–143.

703 Murchie, S. L., Mustard, J. F., Ehlmann, B. L., Milliken, R. E., Bishop, J. L., McKeown, N. K.,  
704 Dobreá, E. Z. N., Seelos, F. P., Buczkowski, D. L., Wiseman, S. M., Arvidson, R. E., Wray, J. J.,  
705 Swayze, G., Clark, R. N., Marais, D. J. D., McEwen, A. S., and Bibring, J.-P. (2009). A synthesis  
706 of Martian aqueous mineralogy after 1 Mars year of observations from the Mars Reconnaissance  
707 Orbiter. *Journal of Geophysical Research: Planets*, 114(E2).

708 Mustard, J. F., Murchie, S. L., Pelkey, S. M., Ehlmann, B. L., Milliken, R. E., Grant, J. A., Bibring, J.-  
709 P., Poulet, F., Bishop, J., Dobreá, E. N., Roach, L., Seelos, F., Arvidson, R. E., Wiseman, S., Green,  
710 R., Hash, C., Humm, D., Malaret, E., McGovern, J. A., Seelos, K., Clancy, T., Clark, R., Marais,  
711 D. D., Izenberg, N., Knudson, A., Langevin, Y., Martin, T., McGuire, P., Morris, R., Robinson,  
712 M., Roush, T., Smith, M., Swayze, G., Taylor, H., Titus, T., and Wolff, M. (2008). Hydrated  
713 silicate minerals on Mars observed by the Mars Reconnaissance Orbiter CRISM instrument. *Nature*,  
714 454(7202):305–309.

715 Patel, M. R., Zarnecki, J. C., and Catling, D. C. (2002). Ultraviolet radiation on the surface of Mars  
716 and the Beagle 2 UV sensor. *Planetary and Space Science*, 50(9):915–927.

717 Poch, O., Kaci, S., Stalport, F., Szopa, C., and Coll, P. (2014). Laboratory insights into the chem-  
718 ical and kinetic evolution of several organic molecules under simulated Mars surface UV radiation  
719 conditions. *Icarus*, 242:50–63.

720 Poch, O., Noblet, A., Stalport, F., Correia, J. J., Grand, N., Szopa, C., and Coll, P. (2013). Chemical  
721 evolution of organic molecules under Mars-like UV radiation conditions simulated in the laboratory  
722 with the “Mars organic molecule irradiation and evolution” (MOMIE) setup. *Planetary and Space*  
723 *Science*, 85:188–197.

724 Poitras, J. T., Cloutis, E. A., Salvatore, M. R., Mertzman, S. A., Applin, D. M., and Mann, P. (2018).  
725 Mars analog minerals' spectral reflectance characteristics under Martian surface conditions. *Icarus*,  
726 306:50–73.

727 Pollack, J. B., Roush, T., Witteborn, F., Bregman, J., Wooden, D., Stoker, C., and Toon, O. B.  
728 (1990). Thermal emission spectra of Mars (5.4-10.5 microns) - Evidence for sulfates, carbonates,  
729 and hydrates. *Journal of Geophysical Research*, 95:14595–14627.

730 Poulet, F., Bibring, J.-P., Mustard, J. F., Gendrin, A., Mangold, N., Langevin, Y., Arvidson, R. E.,  
731 Gondet, B., and Gomez, C. (2005). Phyllosilicates on Mars and implications for early martian  
732 climate. *Nature*, 438(7068):623–627.

733 Rapin, W., Meslin, P. Y., Maurice, S., Vaniman, D., Nachon, M., Mangold, N., Schröder, S., Gasnault,  
734 O., Forni, O., Wiens, R. C., Martínez, G. M., Cousin, A., Sautter, V., Lasue, J., Rampe, E. B.,  
735 and Archer, D. (2016). Hydration state of calcium sulfates in Gale crater, Mars: Identification of  
736 bassanite veins. *Earth and Planetary Science Letters*, 452:197–205.

737 Rull, F., Maurice, S., Hutchinson, I., Moral, A., Perez, C., Diaz, C., Colombo, M., Belenguer, T.,  
738 Lopez-Reyes, G., Sansano, A., Forni, O., Parot, Y., Striebig, N., Woodward, S., Howe, C., Tarcea,  
739 N., Rodriguez, P., Seoane, L., Santiago, A., Rodriguez-Prieto, J. A., Medina, J., Gallego, P., Can-  
740 chal, R., Santamaría, P., Ramos, G., Vago, J. L., and RLS Team (2017). The Raman Laser  
741 Spectrometer for the ExoMars Rover Mission to Mars. *Astrobiology*, 17:627–654.

742 Scheller, E. L., Razzell Hollis, J., Cardarelli, E. L., Steele, A., Beegle, L. W., Bhartia, R., Conrad, P.,  
743 Uckert, K., Sharma, S., Ehlmann, B. L., Abbey, W. J., Asher, S. A., Benison, K. C., Berger, E. L.,  
744 Beyssac, O., Bleefeld, B. L., Bosak, T., Brown, A. J., Burton, A. S., Bykov, S. V., Cloutis, E., Fairén,  
745 A. G., DeFlores, L., Farley, K. A., Fey, D. M., Fornaro, T., Fox, A. C., Fries, M., Hickman-Lewis, K.,  
746 Hug, W. F., Huggett, J. E., Imbeah, S., Jakubek, R. S., Kah, L. C., Kelemen, P., Kennedy, M. R.,  
747 Kizovski, T., Lee, C., Liu, Y., Mandon, L., McCubbin, F. M., Moore, K. R., Nixon, B. E., Núñez,  
748 J. I., Rodriguez Sanchez-Vahamonde, C., Roppel, R. D., Schulte, M., Sephton, M. A., Sharma, S. K.,  
749 Siljeström, S., Shkolyar, S., Shuster, D. L., Simon, J. I., Smith, R. J., Stack, K. M., Steadman, K.,  
750 Weiss, B. P., Werynski, A., Williams, A. J., Wiens, R. C., Williford, K. H., Winchell, K., Wogsland,

751 B., Yanchilina, A., Yingling, R., and Zorzano, M.-P. (2022a). Aqueous alteration processes in Jezero  
752 crater, Mars—implications for organic geochemistry. *Science*, 378:1105–1110.

753 Scheller, E. L., Razzell Hollis, J., Cardarelli, E. L., Steele, A., Beegle, L. W., Bhartia, R., Conrad,  
754 P., Uckert, K., Sharma, S., Ehlmann, B. L., Asher, S., Berger, E. L., Burton, A. S., Bykov, S.,  
755 Fornaro, T., Fox, A. C., Fries, M., Kah, L. C., Kizovski, T., McCubbin, F. M., Moore, K., Roppel,  
756 R., Shkolyar, S. O., Siljeström, S., Williams, A. J., Wogsland, B., and Wiens, R. C. (2022b).  
757 First-Results from the Perseverance SHERLOC Investigation: Aqueous Alteration Processes and  
758 Implications for Organic Geochemistry in Jezero Crater, Mars. *53rd Lunar and Planetary Science  
759 Conference*, 2678:1652.

760 Squyres, S. W., Arvidson, R. E., Bell, J. F., Brückner, J., Cabrol, N. A., Calvin, W., Carr, M. H.,  
761 Christensen, P. R., Clark, B. C., Crumpler, L., Marais, D. J. D., d’Uston, C., Economou, T., Farmer,  
762 J., Farrand, W., Folkner, W., Golombek, M., Gorevan, S., Grant, J. A., Greeley, R., Grotzinger,  
763 J., Haskin, L., Herkenhoff, K. E., Hviid, S., Johnson, J., Klingelhöfer, G., Knoll, A. H., Landis,  
764 G., Lemmon, M., Li, R., Madsen, M. B., Malin, M. C., McLennan, S. M., McSween, H. Y., Ming,  
765 D. W., Moersch, J., Morris, R. V., Parker, T., Rice, J. W., Richter, L., Rieder, R., Sims, M.,  
766 Smith, M., Smith, P., Soderblom, L. A., Sullivan, R., Wänke, H., Wdowiak, T., Wolff, M., and Yen,  
767 A. (2004a). The Opportunity Rover’s Athena Science Investigation at Meridiani Planum, Mars.  
768 *Science*, 306(5702):1698–1703.

769 Squyres, S. W., Grotzinger, J. P., Arvidson, R. E., Bell, J. F., Calvin, W., Christensen, P. R., Clark,  
770 B. C., Crisp, J. A., Farrand, W. H., Herkenhoff, K. E., Johnson, J. R., Klingelhöfer, G., Knoll,  
771 A. H., McLennan, S. M., McSween, H. Y., Morris, R. V., Rice, J. W., Rieder, R., and Soderblom,  
772 L. A. (2004b). In Situ Evidence for an Ancient Aqueous Environment at Meridiani Planum, Mars.  
773 *Science*, 306(5702):1709–1714.

774 Stalport, F., Coll, P., Szopa, C., Cottin, H., and Raulin, F. (2009). Investigating the Photostability of  
775 Carboxylic Acids Exposed to Mars Surface Ultraviolet Radiation Conditions. *Astrobiology*, 9(6):543–  
776 549.

777 Stalport, F., Rouquette, L., Poch, O., Dequaire, T., Chaouche-Mechidal, N., Payart, S., Szopa, C.,  
778 Coll, P., Chaput, D., Jaber, M., Raulin, F., and Cottin, H. (2019). The Photochemistry on Space



779 Station (PSS) Experiment: Organic Matter under Mars-like Surface UV Radiation Conditions in  
780 Low Earth Orbit. *Astrobiology*, 19:1037–1052.

781 ten Kate, I. L., Garry, J. R. C., Peeters, Z., Foing, B., and Ehrenfreund, P. (2006). The effects of  
782 Martian near surface conditions on the photochemistry of amino acids. *Planetary and Space Science*,  
783 54(3):296–302.

784 Turenne, N., Parkinson, A., Applin, D. M., Mann, P., Cloutis, E. A., and Mertzman, S. A. (2022).  
785 Spectral reflectance properties of minerals exposed to martian surface conditions: Implications for  
786 spectroscopy-based mineral detection on Mars. *Planetary and Space Science*, 210:105377.

787 Vaniman, D. T., Bish, D. L., Chipera, S. J., Fialips, C. I., William Carey, J., and Feldman, W. C.  
788 (2004). Magnesium sulphate salts and the history of water on Mars. *Nature*, 431:663–665.

789 Viennet, J.-C., Bultel, B., and Werner, S. C. (2019). Experimental reproduction of the martian  
790 weathering profiles argues for a dense Noachian CO<sub>2</sub> atmosphere. *Chemical Geology*, 525:82–95.

791 Wang, A., Freeman, J. J., Jolliff, B. L., and Chou, I.-M. (2006). Sulfates on Mars: A systematic Raman  
792 spectroscopic study of hydration states of magnesium sulfates. *Geochimica et Cosmochimica Acta*,  
793 70(24):6118–6135.

794 Wiens, R. C., Maurice, S., Robinson, S. H., Nelson, A. E., Cais, P., Bernardi, P., Newell, R. T., Clegg,  
795 S., Sharma, S. K., Storms, S., Deming, J., Beckman, D., Ollila, A. M., Gasnault, O., Anderson,  
796 R. B., André, Y., Michael Angel, S., Arana, G., Auden, E., Beck, P., Becker, J., Benzerara, K.,  
797 Bernard, S., Beyssac, O., Borges, L., Bousquet, B., Boyd, K., Caffrey, M., Carlson, J., Castro,  
798 K., Celis, J., Chide, B., Clark, K., Cloutis, E., Cordoba, E. C., Cousin, A., Dale, M., Deflores, L.,  
799 Delapp, D., Deleuze, M., Dirmyer, M., Donny, C., Dromart, G., George Duran, M., Egan, M., Ervin,  
800 J., Fabre, C., Fau, A., Fischer, W., Forni, O., Fouchet, T., Fresquez, R., Frydenvang, J., Gasway,  
801 D., Gontijo, I., Grotzinger, J., Jacob, X., Jacquino, S., Johnson, J. R., Klisiewicz, R. A., Lake, J.,  
802 Lanza, N., Laserna, J., Lasue, J., Le Mouélic, S., Legett, C., Leveille, R., Lewin, E., Lopez-Reyes,  
803 G., Lorenz, R., Lorigny, E., Love, S. P., Lucero, B., Madariaga, J. M., Madsen, M., Madsen, S.,  
804 Mangold, N., Manrique, J. A., Martinez, J. P., Martinez-Frias, J., McCabe, K. P., McConnochie,  
805 T. H., McGlown, J. M., McLennan, S. M., Melikechi, N., Meslin, P.-Y., Michel, J. M., Mimoun,  
806 D., Misra, A., Montagnac, G., Montmessin, F., Mousset, V., Murdoch, N., Newsom, H., Ott, L. A.,

807 Ousnamer, Z. R., Pares, L., Parot, Y., Pawluczyk, R., Glen Peterson, C., Pilleri, P., Pinet, P.,  
808 Pont, G., Poulet, F., Provost, C., Quertier, B., Quinn, H., Rapin, W., Reess, J.-M., Regan, A. H.,  
809 Reyes-Newell, A. L., Romano, P. J., Royer, C., Rull, F., Sandoval, B., Sarrao, J. H., Sautter, V.,  
810 Schoppers, M. J., Schröder, S., Seitz, D., Shepherd, T., Sobron, P., Dubois, B., Sridhar, V., Toplis,  
811 M. J., Torre-Fdez, I., Trettel, I. A., Underwood, M., Valdez, A., Valdez, J., Venhaus, D., and  
812 Willis, P. (2021). The SuperCam Instrument Suite on the NASA Mars 2020 Rover: Body Unit and  
813 Combined System Tests. *Space Science Reviews*, 217(1):4.

814 Wiens, R. C., Udry, A., Beyssac, O., Quantin-Nataf, C., Mangold, N., Cousin, A., Mandon, L., Bosak,  
815 T., Forni, O., McLennan, S. M., Sautter, V., Brown, A., Benzerara, K., Johnson, J. R., Mayhew,  
816 L., Maurice, S., Anderson, R. B., Clegg, S. M., Crumpler, L., Gabriel, T. S. J., Gasda, P., Hall, J.,  
817 Horgan, B. H. N., Kah, L., Legett, C., Madariaga, J. M., Meslin, P.-Y., Ollila, A. M., Poulet, F.,  
818 Royer, C., Sharma, S. K., Siljeström, S., Simon, J. I., Acosta-Maeda, T. E., Alvarez-Llamas, C.,  
819 Angel, S. M., Arana, G., Beck, P., Bernard, S., Bertrand, T., Bousquet, B., Castro, K., Chide, B.,  
820 Clavé, E., Cloutis, E., Connell, S., Dehouck, E., Dromart, G., Fischer, W., Fouchet, T., Francis,  
821 R., Frydenvang, J., Gasnault, O., Gibbons, E., Gupta, S., Hausrath, E. M., Jacob, X., Kalucha, H.,  
822 Kelly, E., Knutsen, E., Lanza, N., Laserna, J., Lasue, J., Le Mouélic, S., Leveille, R., Lopez Reyes,  
823 G., Lorenz, R., Manrique, J. A., Martinez-Frias, J., McConnochie, T., Melikechi, N., Mimoun,  
824 D., Montmessin, F., Moros, J., Murdoch, N., Pilleri, P., Pilorget, C., Pinet, P., Rapin, W., Rull,  
825 F., Schröder, S., Shuster, D. L., Smith, R. J., Stott, A. E., Tarnas, J., Turenne, N., Veneranda,  
826 M., Vogt, D. S., Weiss, B. P., Willis, P., Stack, K. M., Williford, K. H., Farley, K. A., and THE  
827 SUPERCAM TEAM (2022). Compositionally and density stratified igneous terrain in Jezero crater,  
828 Mars. *Science Advances*, 8(34):eabo3399.

829 Yen, A. S., Murray, B., Rossman, G. R., and Grunthner, F. J. (1999). Stability of hydroxylated  
830 minerals on Mars: A study on the effects of exposure to ultraviolet radiation. *Journal of Geophysical*  
831 *Research: Planets*, 104(E11):27031–27041.