



HAL
open science

Triboelectric-Powered System for Pedestrian and Vehicle Detection with Wireless Data Transmission

Ahmad Delbani, Armine Karami, Dimitri Galayko, Naida Hodzic, Srikumar Vaidyanathan, Malal Kane, Philippe Basset

► **To cite this version:**

Ahmad Delbani, Armine Karami, Dimitri Galayko, Naida Hodzic, Srikumar Vaidyanathan, et al.. Triboelectric-Powered System for Pedestrian and Vehicle Detection with Wireless Data Transmission. 2022 21st International Conference on Micro and Nanotechnology for Power Generation and Energy Conversion Applications (PowerMEMS), Dec 2022, Salt Lake City, UT, United States. pp.138-141, 10.1109/PowerMEMS56853.2022.10007557 . hal-04304841

HAL Id: hal-04304841

<https://hal.science/hal-04304841v1>

Submitted on 24 Nov 2023

HAL is a multi-disciplinary open access archive for the deposit and dissemination of scientific research documents, whether they are published or not. The documents may come from teaching and research institutions in France or abroad, or from public or private research centers.

L'archive ouverte pluridisciplinaire **HAL**, est destinée au dépôt et à la diffusion de documents scientifiques de niveau recherche, publiés ou non, émanant des établissements d'enseignement et de recherche français ou étrangers, des laboratoires publics ou privés.

TRIBOELECTRIC-POWERED SYSTEM FOR PEDESTRIAN AND VEHICLE DETECTION WITH WIRELESS DATA TRANSMISSION

Ahmad Delbani¹, Armine Karami², Dimitri Galayko³, Naida Hodzic², Srikumar Vaidyanathan²,
Malal Kane¹ and Philippe Basset²

¹Univ Gustave Eiffel, EASE/AME, Bouguenais, France

²Univ Gustave Eiffel, CNRS, ESYCOM, F-77454 Marne-la-Vallée, France and

³Sorbonne Université, CNRS, LIP6, Paris, France

ABSTRACT

This paper report an autonomous and wireless system for detecting the passage of a human (pedestrian) or a vehicle based on a basic and low-cost triboelectric sensor/generator made of a PTFE sheet and aluminum plates' transducer. A high-voltage conditioning circuit using a plasma switch and a 2-stage power management system is supplying a BLE module comprising 5 sensors. These sensors are being supplied solely from the harvested energy generated by the triboelectric transducer (TENG) after an initial pre-charge. In preliminary laboratory tests, up to 200 μ J where generated by a single human step, and three steps are sufficient to send the sensor data. Furthermore, we have demonstrated the data transmission/detection of each human step without any additional electronics, but only with the DC rectifier and the plasma switch using the principle of the Hertz experiment.

KEYWORDS

Kinetic energy harvesters, TENG, 2-stage power management system, plasma switch, road/pavement sensor.

INTRODUCTION

We are living in an era where there is a huge demand for new power sources due to the non-sustainable source's exhaustion, accompanied with the fast and vast production of small electronics in its various kinds. Throughout the years, the roads kept evolving and adapting with the technology. The roads of tomorrow will be intelligent, automated and will communicate sensor data with the vehicles and base stations. These sensors will regularly measure and transmit various information (quantity, type, weight of vehicles, temperature, humidity, etc....) [1]. A regular power supply for these sensors, which are abandoned, is necessary. Considering the traffic density in a metropolitan center, it is conceivable that a large amount of mechanical energy is spent every day and wasted. The challenge consists of recovering a part of this energy and use it to help these future roads in the communication of their sensors with their environment.

A triboelectric energy generator (TENG) is a transducer that converts mechanical energy to electricity, based on contact electrification and electrostatic induction principles that could be incorporated into the roads. To power the electronic device or sensor, a regulated DC voltage should be provided at the output. A power management system (PMS) is needed to optimize the mechanical-to-electrical energy transduction and to perform the AC-DC conversion to a low DC voltage around

a few volts compatible transmission module. We have proposed two approaches for the data transmission of the pedestrian/vehicle detection. The first one is based on a BLE module connected at the output of the PMS. The other approach follows the principle of the famous Hertz experiment [2] where an electrostatic sparkle, generated when a plasma switch is activated, induces an electromagnetic wave that can be detected several meters away with a simple coil antenna.

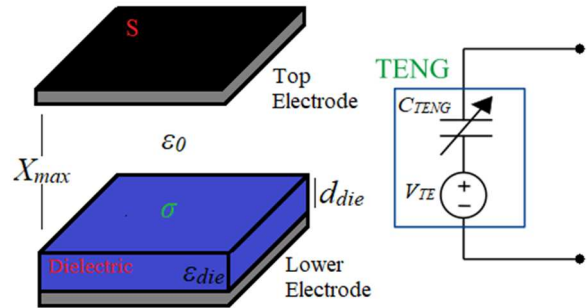

Figure 1: TENG electrical model.

DESCRIPTION OF THE TRANSDUCER

Electrical model

A TENG is a capacitive device, which at least one electrode is covered by a dielectric material that has the tendency to trap a specific type of charges. This layer is inserted between the device's electrodes, and it acts as an electret. Charges are spread on its surface by mechanical contact. A simple model is shown in Figure 1. The charges are concentrated at the surface of a tribo-electret layer of thickness d_{die} and permittivity ϵ_{die} , with an effective surface charge density distribution σ , over a surface S . The variable air gap is X_{max} with a permittivity ϵ_0 . After a pre-charge by contact electrification, the variation of the charged capacitor due to external mechanical forces will generate electrical energy by electrostatic induction. The variable capacitance, which varies between C_{max} and C_{min} , is defined as:

$$C_{TENG} = \frac{\epsilon_0 S}{\frac{d_{die}}{\epsilon_{die}} + \frac{X_{max}}{2} - \frac{X_{max}}{2} * \cos(2\pi f t)} \quad (1)$$

The build-in triboelectric voltage V_{TE} is the defined as:

$$V_{TE} = \frac{\sigma * d_{die}}{\epsilon_0 * \epsilon_{die}} \quad (2)$$

Transducer's Mechanical Design

A structure has been designed to handle the pressure of a passing vehicle (Figure 2) from which the mechanical energy is converted into electricity. The structure has the size of a car's tire and has the ability to retract to its zero position thanks to metallic springs. Two road bumps with a movable upper vertical plate have been fabricated. The transducer has a surface of up to 625 cm² and can be excited with a vertical deflection from a few mm to a few cm.



Figure 2: Fabricated Devices.

The transducer is made of two aluminum electrodes, one of them being covered with a PTFE sheet of 25x23 cm² wide and 100 μm thick glued with double-sided adhesive tape (see Figure 3). A foam layer is added between the electrodes and the supporting frame for improving the transducer's reliability.

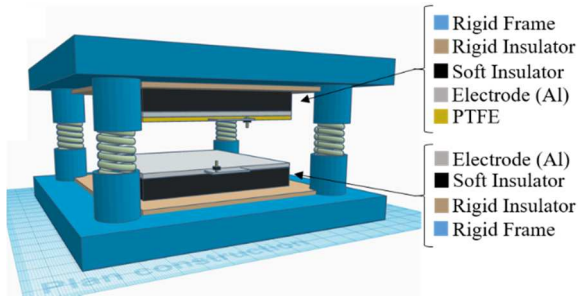

Figure 3: 3D view of the transducer.

THE POWER MANAGEMENT SYSTEM

Signal rectification

The full-wave (FW) diode bridge is the most used conditioning circuit for rectifying the AC signal at a TENG output. As a stable charge pump, it reaches a saturation. The saturation voltage of the half-wave bridge (HW) is higher by a factor $(\eta+1)$, where η is the C_{max}/C_{min} capacitance ratio of the TENG. During the first cycles, the harvested energy of the FW rectifiers increases with 4 times the slope of the HW, in spite of the fact that in that case both harvested energies are far from the optimal of each circuit [3]. Moreover, if the output voltage of the rectifier can be set to be half of its saturation voltage, HW surpasses the FW by a factor $(\eta+1)/2$ in terms of performance [4].

Unstable charge pumps such as the Bennet doubler conditioning circuit have the ability to increase exponentially the charge on the TENG's electrodes during operation and to increase its bias and conversion efficiency. A minimum value of η should be satisfied, which is typically 2 for the most simple architecture, but it can vary depending on the circuit configuration [5]. While the output

energy can be greatly improved by the unstable charge pumps, their main disadvantage is that it may take some time for reaching the conditions for a high-energy conversion [4]. This period is mostly depending on the value of η and the ratio between the load capacitance and C_{min} [3]. In our application, we intend to reach quickly a very high voltage to actuate a high-voltage (HV) plasma switch and increase the energy conversion per mechanical actuation, so the HW rectifier is the better choice.

2-stage Power Management System (PMS)

A PMS should be introduced after the rectification process to adapt the high-voltage rectified signal to a compatible (low) DC voltage for the load. A practical solution is to use a 2-stage architecture to maintain a high voltage across the TENG while a DC-DC Buck down-converter lower the voltage across a large storage capacitor C_{store} (see Figure 4). One of the main component in our PMS is the plasma switch, which is a fully autonomous switch that does not need any additional electronics [6]. Its actuation voltage is defined by the Paschen law. When the potential across the switch terminals, which are separated by a micro-gap, reaches a certain value in the range of hundreds of volts, an electrical spark is formed between them and thus conduction will occur.

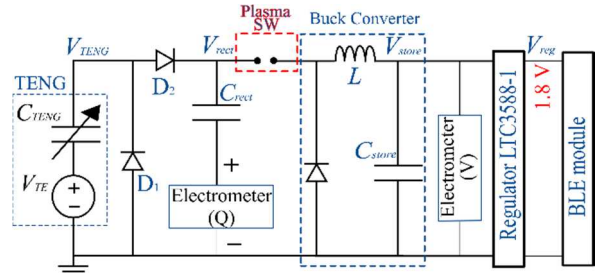

Figure 4: Setup for the experiment with the BLE communication.

EXPERIMENTS

Figure 5 shows the conditioning circuit implementation. The evolution of the charges flowing through C_{rect} is measured by an electrometer while the TENG is mechanically excited by a pedestrian. Then the energy stored inside C_{rect} can be calculated accordingly using the formula:

$$E_{rect} = \frac{Q_{rect}^2}{2C_{rect}} \quad (3)$$

Figure 6 shows the measured voltage across C_{rect} . After one pedestrian excitation, it reaches 633 V, corresponding to an energy of 200 μJ. Choosing a value of C_{rect} in the same order of magnitude of C_{max} helps to have a high voltage across C_{rect} . Thus, the plasma switch can actuate with a minimal amount of pedestrian steps. The TENG dynamic capacitance time variation C_{TENG} has been measured using the technique depicted in [8], showing $C_{min} = 330$ pF and C_{max} in the range of 1800-2100 pF.



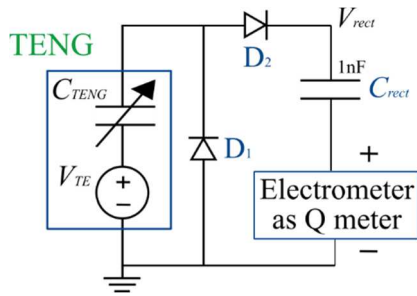

Figure 5: Conditioning circuit used.

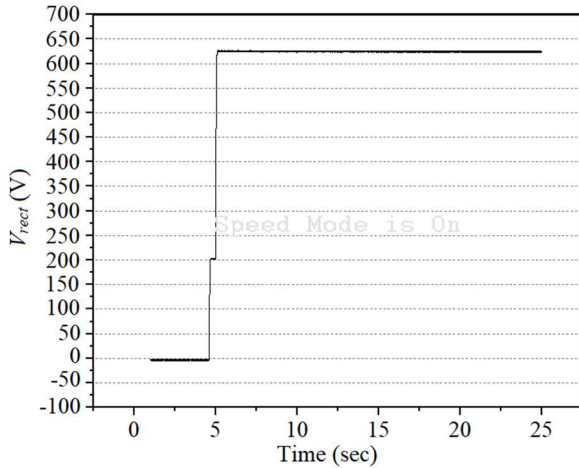

Figure 6: Measured voltage across C_{rect} .

2-Stage PMS and BLE communication

The 2-stage PMS comprises a half-wave rectifier, a buck DC-DC converter with a “hand-made” plasma switch, a commercial voltage regulator (LTC-3588) and a BLE module (RIOT-001). Each diode from the rectifier has the capability to handle up to 1.6 kV, so that we insure of not having any breakdown or damage in the circuitry upon the mechanical excitations.

Figure 7 shows that 3~4 steps are necessary to actuate the plasma switch that has ON/OFF actuation voltages of 1.25 kV / 450 V respectively. After the DC-DC buck converter, the voltage is below 10 V across $C_{store} = 100 \mu\text{F}$, as shown in figure 8. At the output of the regulator, the BLE module is powered at 1.8 V.

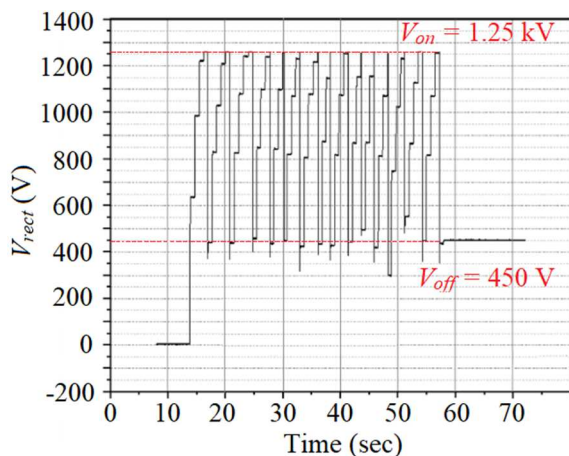

Figure 7: Voltage across C_{rect} showing the plasma switch hysteresis.

A transfer of charges from C_{rect} to C_{store} is obtained at each actuation of the plasma switch. The first voltage-drop of ~ 3.5 V across C_{store} corresponds to the wake-up of the BLE module. In the experiment, this initial voltage drop has been obtained thanks to an external voltage source. Then $232 \mu\text{J}$ are transferred at each switch actuation (increasing voltage), which triggers the sending of a data packet at the energy cost of $137 \mu\text{J}$ (decreasing voltage). The sensors’ data can then be read on an android app.

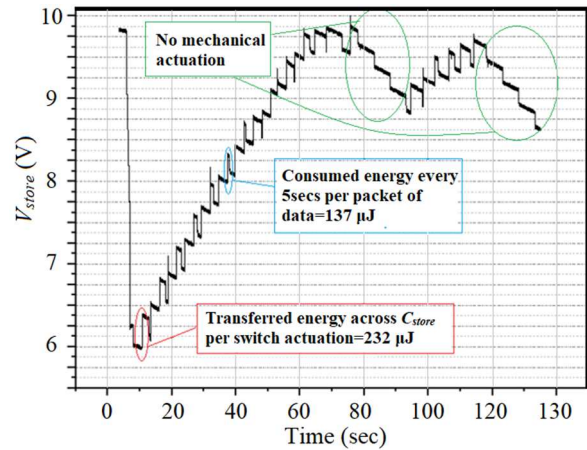

Figure 8: Voltage across C_{store} . Each down step corresponds to one packet of transmitted data with the BLE module.

Alternative transmission scheme

When the plasma switch is activated, the generated sparkle induces an electromagnetic wave that can be detected several meters away with a simple coil antenna, following the principle of the famous Hertz experiment [1].

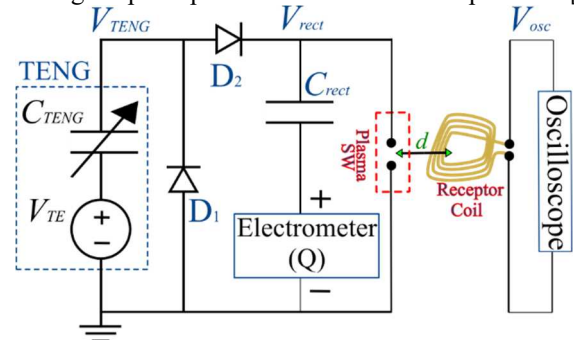

Figure 9: Setup for the transmission at distance “d” based on the Hertz experiment

In this experiment, the plasma switch has been modified so that the switch ON actuation voltage is reduced to 370 V, so it is activated at each step. Figure 10 shows the received signal with a 3-turn coil of 5 cm diameter at 2 meters away from the plasma switch. The maximum amplitude of the received signal gives an indication of the force applied on the transducer. This approach is very promising since almost no electronic is needed to transmit the information.

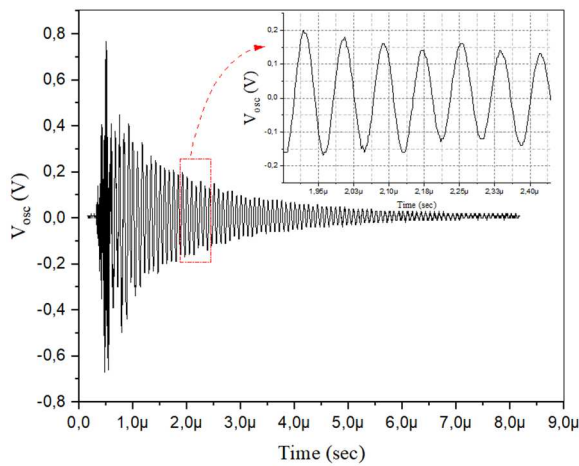

Figure 10: Voltage across the coil at a distance of 2 meters after a plasma switch actuation

CONCLUSION

We have demonstrated electrical power generation and data transmission with a BLE module using a triboelectric power generator embedded in a road bump. During these preliminary tests, 200 μJ were obtained from scratch with a single human step. Considering that a car is much heavier and would generate four actuations (one per tire), the energy harvested in a real situation should be at least one order of magnitude higher. 232 μJ were transferred to the storage capacitor by the 2-stage PMS at each switch actuation, which is enough to send a packet of data with the BLE module. Taking benefit of the electromagnetic wave generated by the plasma switch actuation, a low-power data transmission system can be obtained. The amplitude of the received signal gives an indication of the force applied on the transducer. This approach is very promising since almost no electronic is needed to transmit the information.

REFERENCES

- [1] A. Pompigna and M. Raffaele, "Smart roads: a state of the art of highways innovations in the Smart age", *Engineering Science and Technology, an International Journal*, vol. 25, p. 100986, 2022
- [2] H. Wang *et al.* "A paradigm shift fully self-powered long-distance wireless sensing solution enabled by discharge-induced displacement current", *Science Advances*, vol. 7, no. 39, p. 6751, 2021
- [3] H. Zhang *et al.* "General analysis and optimization of a two-stage power management circuit for electrostatic/triboelectric nanogenerators", *Nano Energy*, p. 107816, 2022,
- [4] A. Ghaffarinejad *et al.* "Superior performance of half-wave to full-wave rectifier as a power conditioning circuit for triboelectric nanogenerators: application to contact-separation and sliding mode TENG", *Nano Energy*, vol. 66, p. 104137, 2019
- [5] A. Karami *et al.* "Series-parallel charge pump conditioning circuits for electrostatic kinetic energy harvesting", *IEEE Transactions on Circuits and Systems I: Regular Papers*, vol. 64, no. 1, pp. 227–40, 2017
- [6] H. Zhang, Marty, F., Xia, X. *et al.* "Employing a MEMS plasma switch for conditioning high-voltage kinetic energy harvesters", *Nature Communications*, 11, 3221, 2020
- [7] Y. Lu, *et al.* "A batch-fabricated electret-biased wideband MEMS vibration energy harvester with frequency-up conversion behavior powering a UHF wireless sensor node" *Journal of Micromechanics and Microengineering*, vol. 26, no. 12, p. 124004, 2016

CONTACT

*Ahmad Delbani

E-mail: ahmad.delbani@univ-eiffel.fr

