



Integrated Technology in SiC for Harsh Environment Power Electronics, Sensors and Quantum Nanophotonics

- Mihai LAZAR -

Light, Nanomaterials & Nanotechnologies (L2n), CNRS EMR 7004,
University of Technology of Troyes, 12 rue Marie Curie, 10004 Troyes,
France

mihai.lazar@utt.fr



SiC – one of the most technologically advanced wide bandgap semiconductor

	E_g (eV)	ϵ_r	μ_n ($\text{cm}^2 \cdot \text{V}^{-1} \cdot \text{s}^{-1}$)	μ_p ($\text{cm}^2 \cdot \text{V}^{-1} \cdot \text{s}^{-1}$)	E_c ($\text{MV} \cdot \text{cm}^{-1}$)	v_{sat} ($10^7 \text{cm} \cdot \text{s}^{-1}$)	λ ($\text{W} \cdot \text{cm}^{-1} \cdot \text{K}^{-1}$)
Si	1,1	11,8	1450	500	0,2-0,8	1	1,5
2H-GaN	3,39	9	900	350	3,3	2,5	1,3
GaAs	1,42	12,9	8000	400	0,4-0,9	0,7	0,46
3C-SiC	2,2	9,6	900	45	1,2	2	4,5
6H-SiC	3	9,7	370	90	2,4	2	4,5
4H-SiC	3,26	10	600	115	2	2	4,5
Diamond	5,45	5,5	1900	3800	5,6	2,7	20

Electronic fields:
High temperature
High power
Compact systems
Low switching losses
High-frequency

Harsh environment
Strong interatomic bonding
High chemical inertness
Good bio-compatibility

Crystal structure: more than 200 polytypes:

SiC:

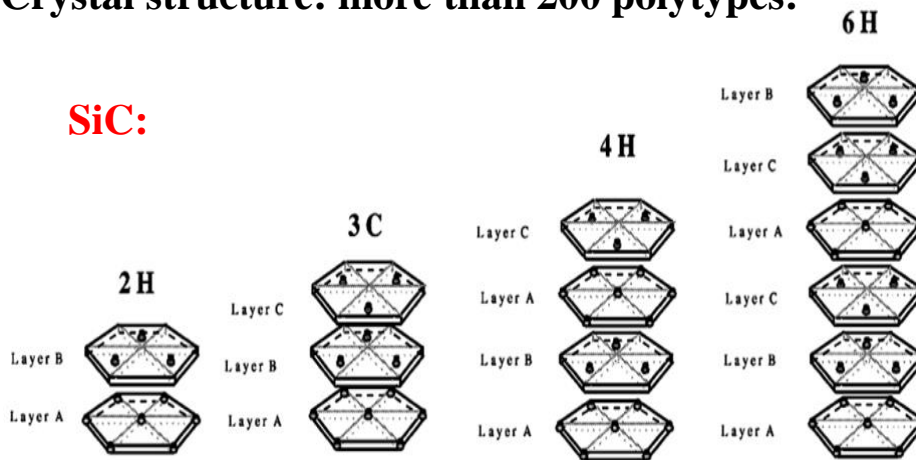

Hardness (Mohs scale)

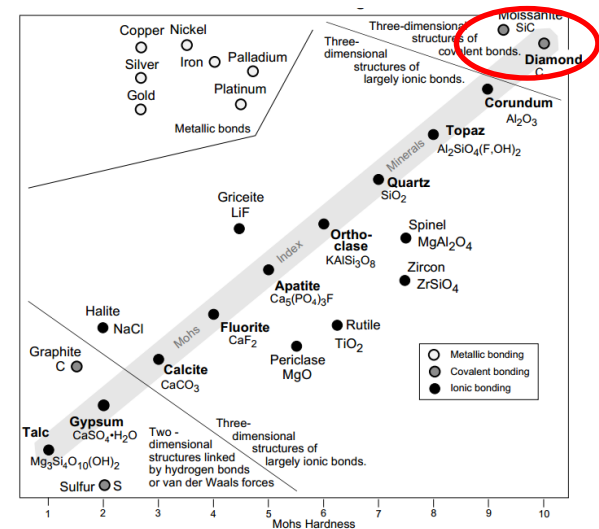

Particular and complex processes for the growth and technology

"ingot growth" SiC~2000°C (without liquid phase)

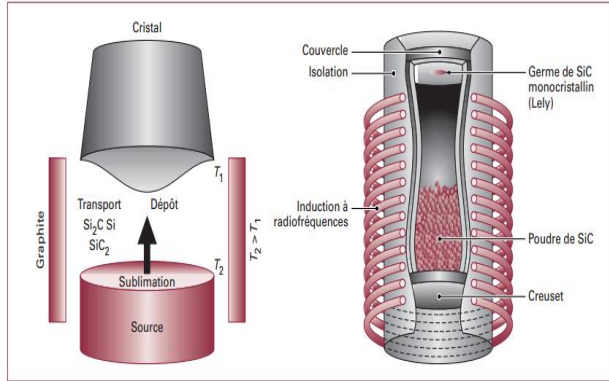

Considerable « cost »

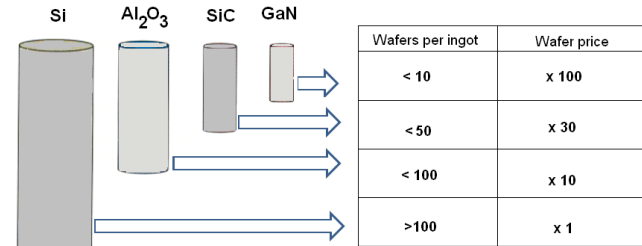

M.A. Fraga et al, "Silicon Carbide in Microsystem Technology - Thin Film Versus Bulk Material", 2015, INTECH Ed

But remarkable industrial investments in power electronics over the last decades:

- continuous progress in reduction of defect densities,
- increase of wafer size
- and lowering of wafers costs.

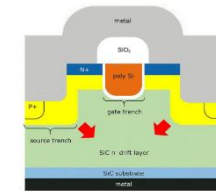
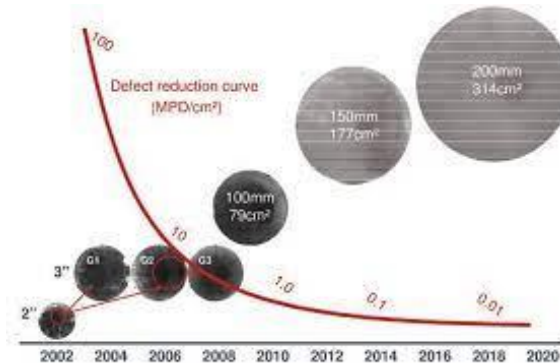

MOSFET in SiC



Power discrete SiC devices already commercialized (Farnell...)

Main industrial developments in recent years for the manufacture of power devices in SiC (4H-SiC)

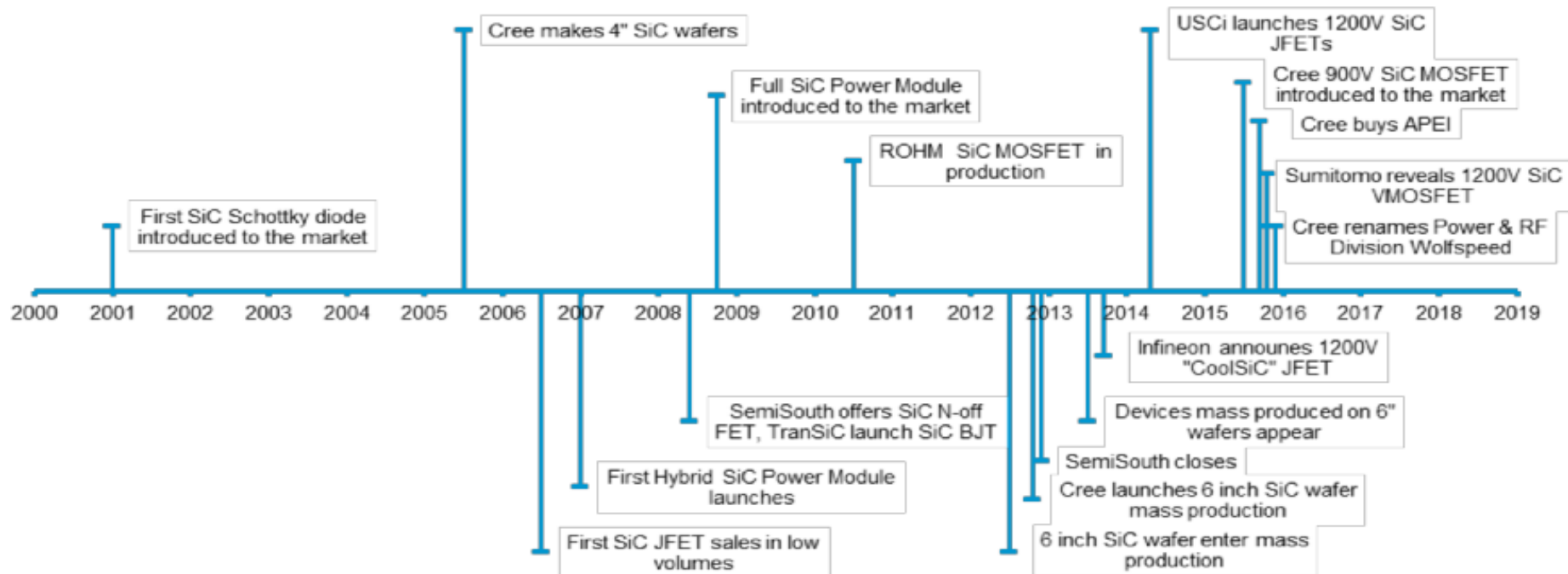

Critical technological steps to develop (power) devices in SiC:

- Improve the quality of the SiC substrate:
 - decrease the density of the point and extended defects: "micropipes" , dislocations ;
 - increasing the wafer size – to fit with Si technological compatibility.
- Doping: a fundamental step to create active layers
 - mainly by ion implantation ;
 - needing high temperature annealing $\sim 1700^\circ$ to recover the crystal crystallinity and to activate the doping ;
 - avoiding Si sublimation and thus a doping loss by SiC etching ;
 - use a C-cap to encapsulate the substrate.
- Packaging, surface and interface improvements:
 - MOS interface : SiO_2/SiC : decrease the interface trap density ;
 - develop a robust packaging to fully benefit from the SiC properties.

SiC technological developing today

Power electronics :

- **Monolithic integration of SiC devices in the same single crystal wafer**
 - to improve reliability in power electronics,
 - to reduce the size of converters,
 - to improve the switching operation speed,
 - to decrease the power loss.
- **Increasing the breakdown voltage of the single discrete devices (~30 kV)**

New emerging application fields:

- **Quantic nanophotonics and robust optoelectronics**
 - Color centers in SiC – (near)IR emission at RT
 - SiC white LED – without rare-earth metals.
- **Harsh environment sensors**
 - neutron detectors, UV photodectors , bio – electrochemical sensors...

From end of 2018: a new technological line we develop for SiC 100/150 mm



Two platforms (clean-rooms):

- ESIEE (Paris Marne-la-Vallée): **proved Si 100/150 mm technology**
- Nano'Mat (Troyes/Reims) : **SiC specific and complementary machines**

Not only for power electronics but also for the new emerging fields:

- sensors with SCR, piezo, bio-electrochemical
- nanophotonics, optoelectronics, plasmonics

A technological transfer of know-how developed in Lyon (limited to 50mm).

Support from academic projects (ANR, Europe, Région GE...) and direct demand from industrial partners

ESIEE
PARIS



UMR CNRS 9007

ESIEE Paris cleanrooms



650 m² in ISO 5 and ISO 7

120 equipments to cover fully and standard steps to fabricate μ -systems and μ -sensors :

- Thin films deposition, thermal oxidation, photolithography, wet and dry plasma etching, wet chemical cleaning, electroplating, wire-bonding, wafer cutting, back-end packaging.



ESIEE Paris cleanrooms

Different technological lines :

- more classic (Si, glass, piezoelectric materials)
- more specifics (flexible systems with integrated carbonic materials: diamond, nanotubes, graphene).

Each equipment is compatible with:

- 4 inches wafers
- 2 to 8 inches for certain steps.
- not for parts or little samples!

Several industrial partners implanted in this cleanroom

For SiC 100mm technological line we validated:

- Wet chemical cleaning and etching
- UV lithography (positive and negative photoresist, double-side, lift-off)
- Thermal oxidation (dry and wet)
- Sputtering: Ni, TiW, Au, SiO₂ (metal contacts, plasma etching and ion implantation masks)
- LPCVD and PECVD with Si₃N₄
- Plasma etching (RIE et DRIE) to locally open thin films, dielectrics (up to ~2µm)
- Cutting SiC wafers with Disco DAD dicing saw

All these machines are currently used at ESIEE on 100mm silicon wafers for academic and industrial projects





EMR CNRS 7004



www.nanomat.eu



Specific and dedicated equipments for SiC (compatibles for 100mm)

- SiC ICP/RIE plasma etching
- Post-ion implantation annealing at high temperatures : AET RTP 1900°C furnace
- E-beam evaporators: Ni/Ti/Al (p-type contact) Si
- RTA annealing - JIPELEC JETFirst furnace, an equipment also present at URCA and that we frequently used
- E-beam lithographie (quantum technology)



At Nano'Mat we utilized less technological equipments but they are indispensable and represents key steps.



Physico-chemical characterizations : FEGSEM, AFM, KPFM, μ Raman, PL...

L2n – Nano-microfabrication of electronic devices in SiC

Local plasma etching of 4H-SiC layers

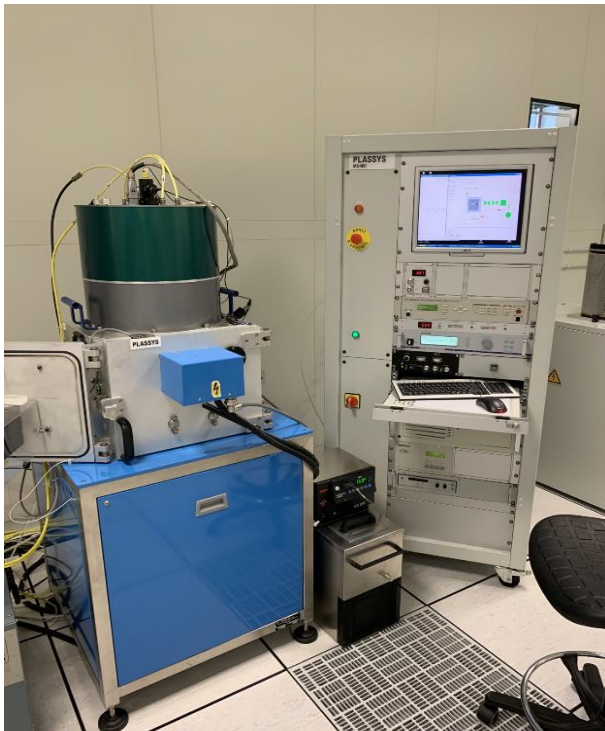
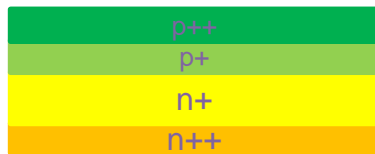

- ICP/RIE etching with SF_6
→ MU400 Plassys reactor

~35 μm mesa and via

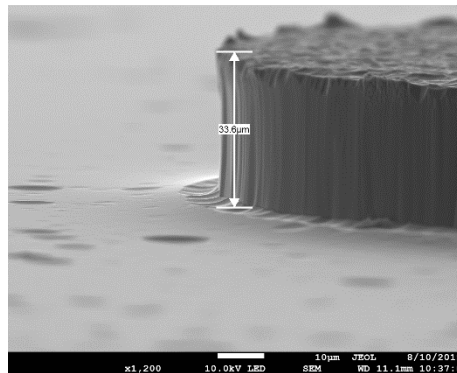

“isotropic” etching
- ICP mode

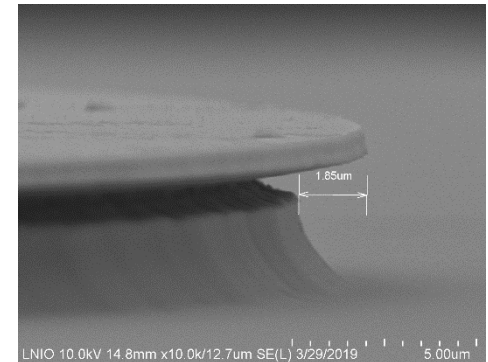

High temperature post –ion implantation annealing and recrystallisation of SiC thin layers

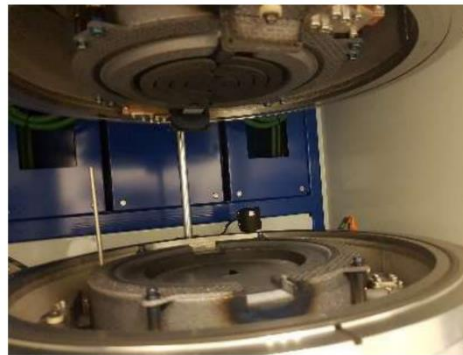

RTP

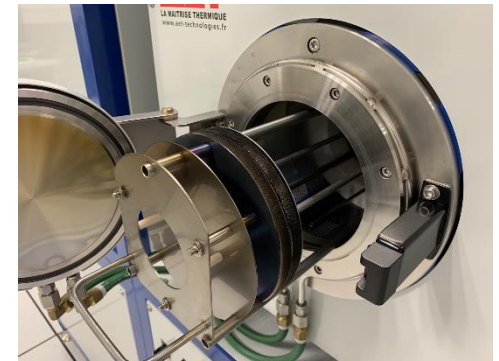

Pyrolyse

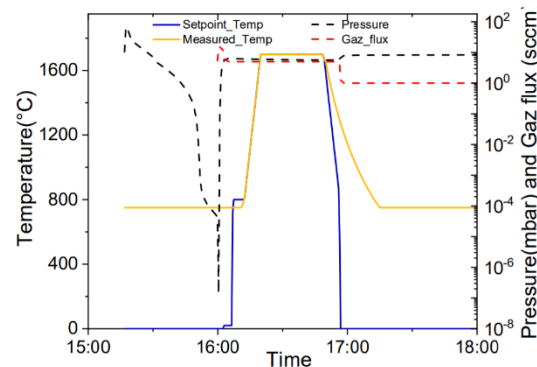

RTP pressure and temperature profiles under Ar with a plateau of 30min at 1700°C

AET furnace

- RTP chamber with graphite resistors : heating temperature: 800 et 2000°C under Ar.
- More classic quartz tube chamber to form C-cap layer by pyrolyse : up to 900°C under Ar.

L2n – Nano-characterization of electronic devices in SiC

AFM/KPFM : Atomic/Kelvin Probe Force Microscopy

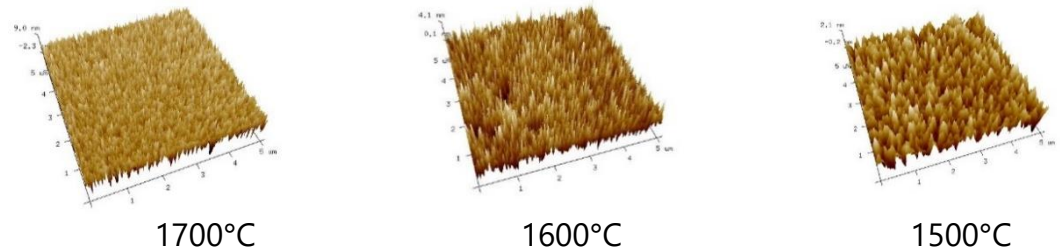
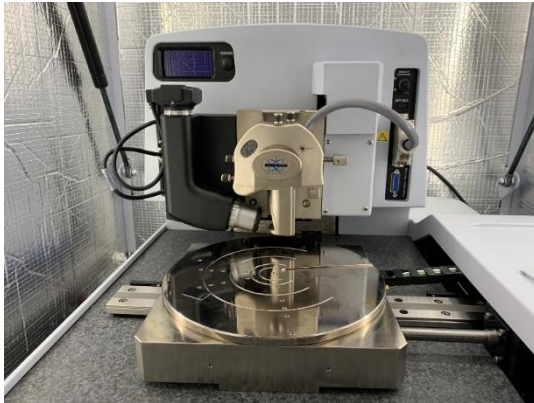

4H-SiC surface topography after annealing at different temperatures

- Bruker's Dimension Icon Peak Force :
- SiC surface topography
 - Roughness: AR layers control of light emission/absorption

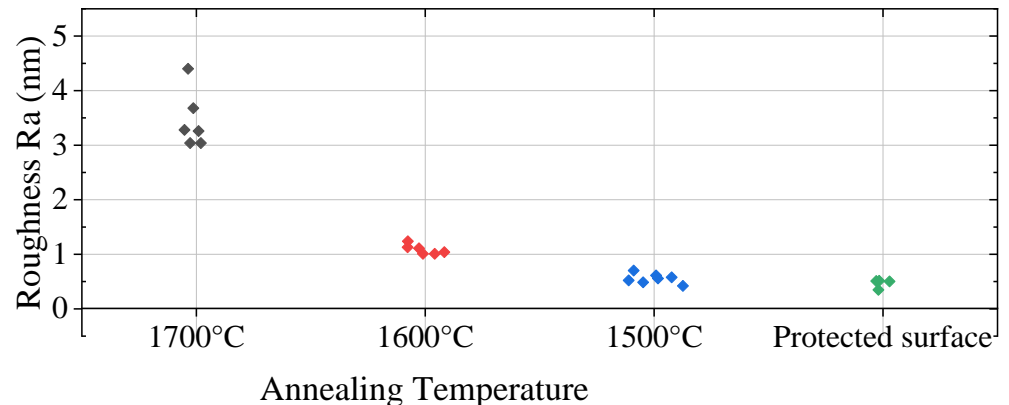

4H-SiC roughness (Ra): control of the light emission/ absorption

L2n – Nano-characterization of electronic devices in SiC

AFM/KPFM : Atomic/Kelvin Probe Force Microscopy

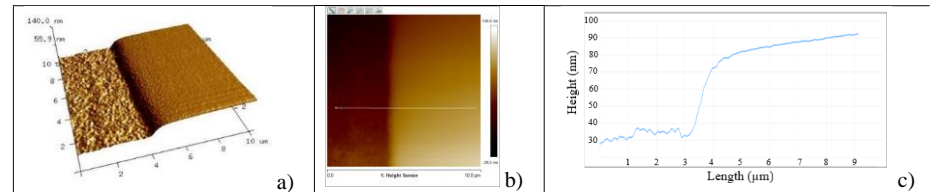
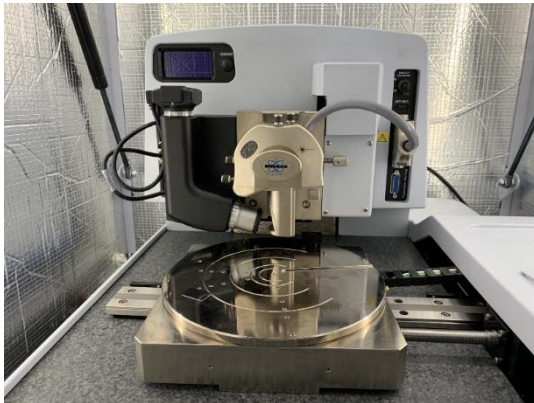

Protected area boundary patterned by photolithography after 1600°C annealing.

- Bruker's Dimension Icon Peak Force :
- SiC surface topography
 - Roughness: AR layers control of light emission/absorption

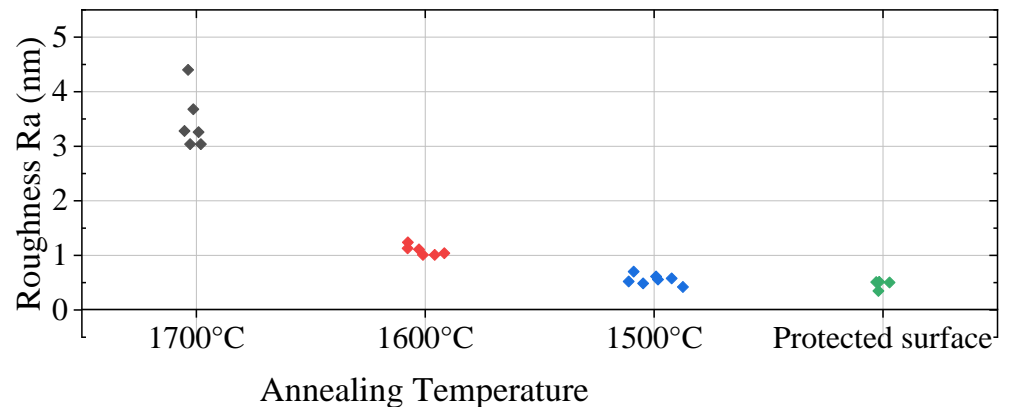

4H-SiC roughness (Ra): control of the light emission/ absorption

L2n – Nano-characterization of electronic devices in SiC

AFM/KPFM : Atomic/Kelvin Probe Force Microscopy

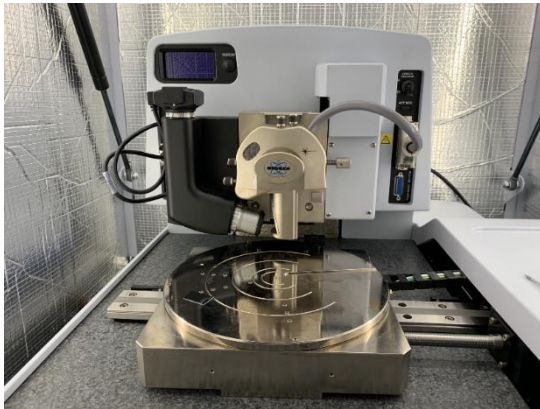

- Bruker's Dimension Icon Peak Force :
- SiC surface topography
 - Roughness: AR layers control of light emission/absorption
- KPFM – p/n junction cartography

SiC integrated circuit with lateral JFET

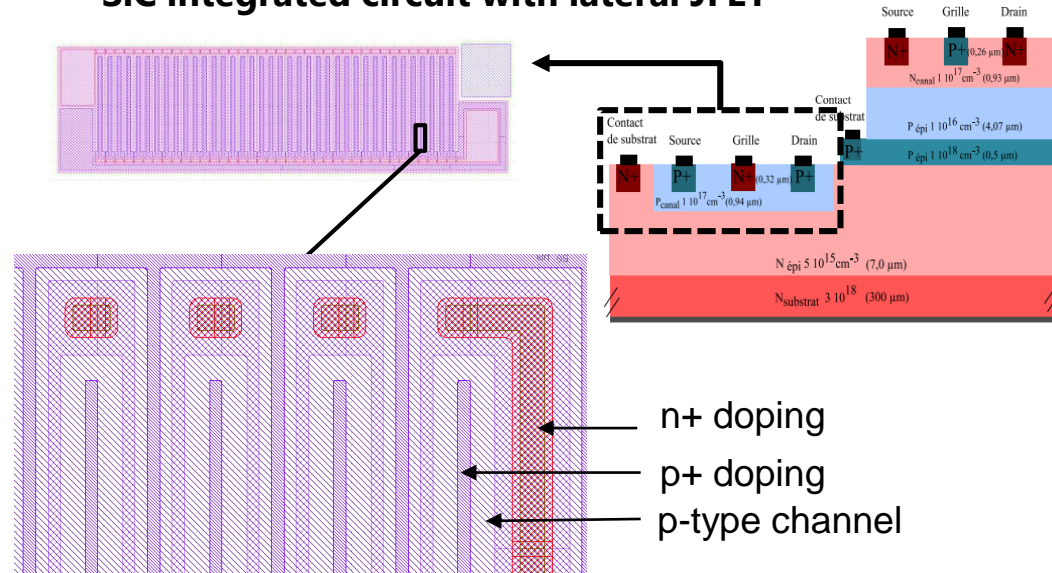

KPFM: surface potential microscopy (WF)

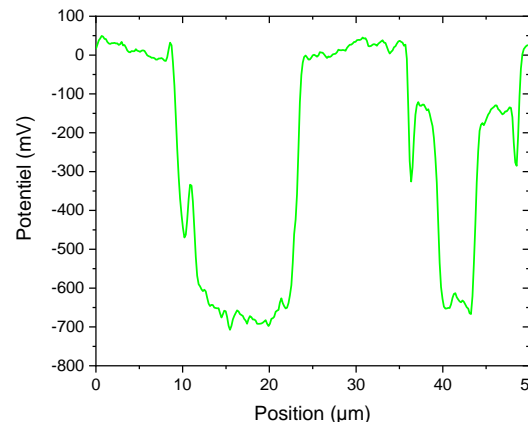

- p+ and n+ layers are identified from p-type channel
- A difference of 700mV between p and n-type layers
- Smooth surface topography (AFM – not shown)

L2n – Nano-characterization of electronic devices in SiC

μ-Raman Microscopy

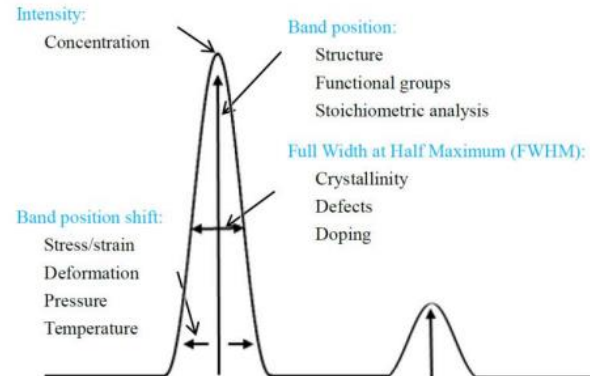
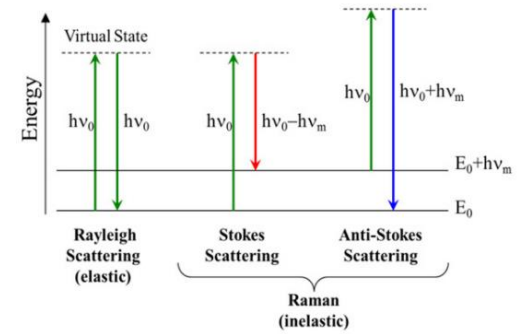
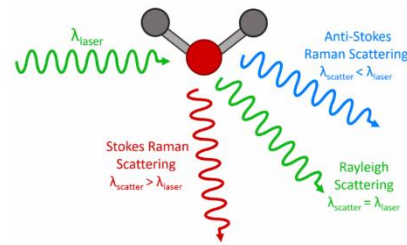
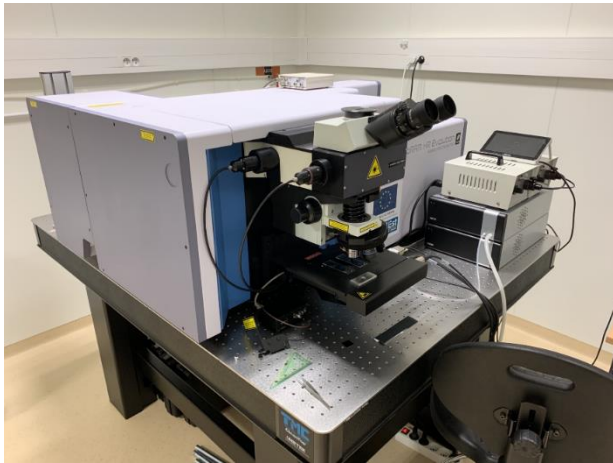

- SiC strong interatomic bonding
→ favourable for Raman scattering diffraction
- Raman very sensitive to crystal structure, polytype, defects, doping ...
- PL also possible (from 320 to 1000nm)

L2n – Nano-characterization of electronic devices in SiC

μ-Raman Microscopy

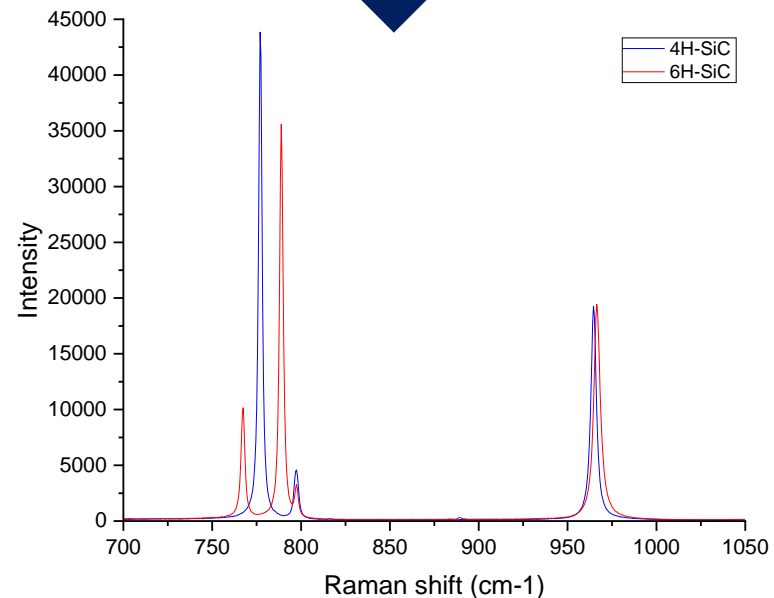
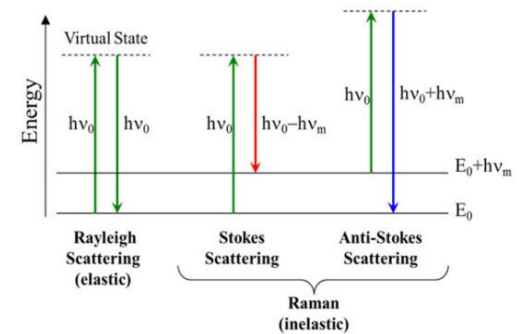
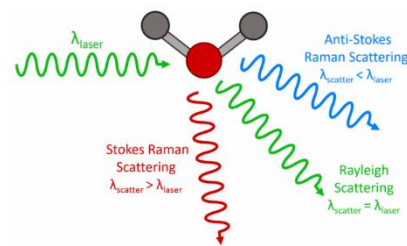
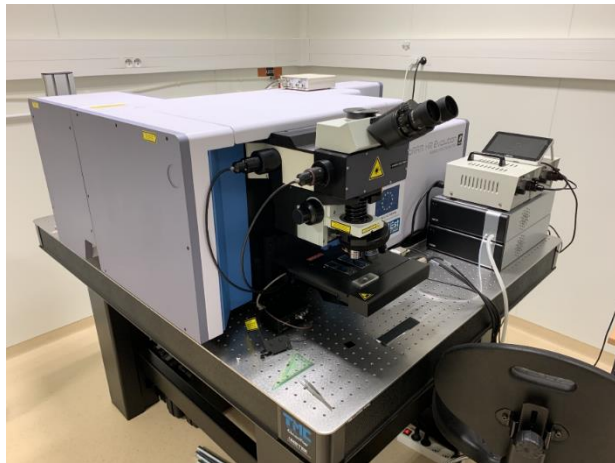

- SiC strong interatomic bonding
→ favourable for Raman scattering diffraction
- Raman very sensitive to crystal structure, polytype, defects, doping ...
- PL also possible (from 320 to 1000nm)

L2n – Nano-characterization of electronic devices in SiC

μ-Raman Microscopy

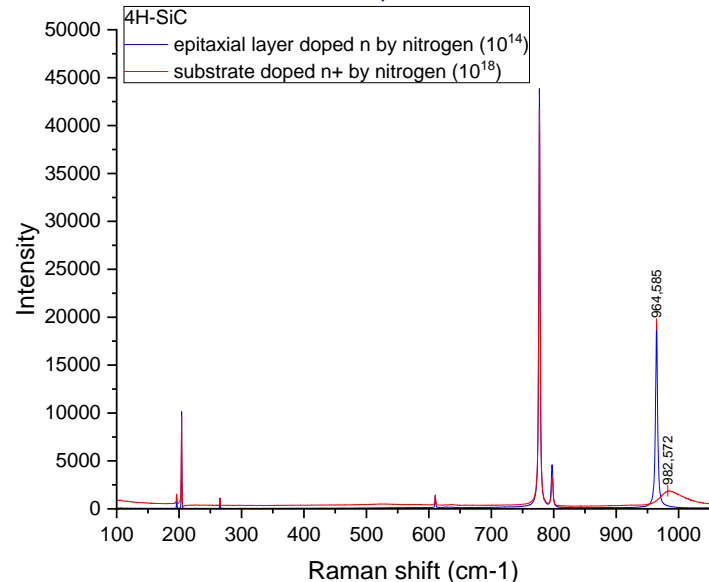
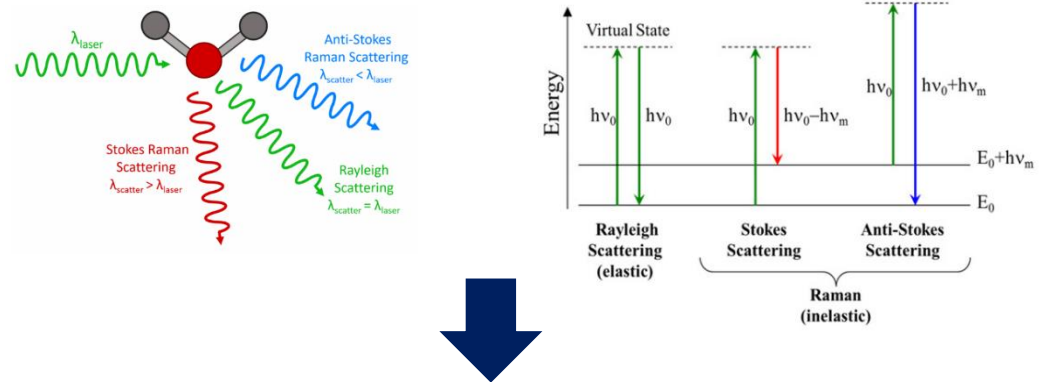
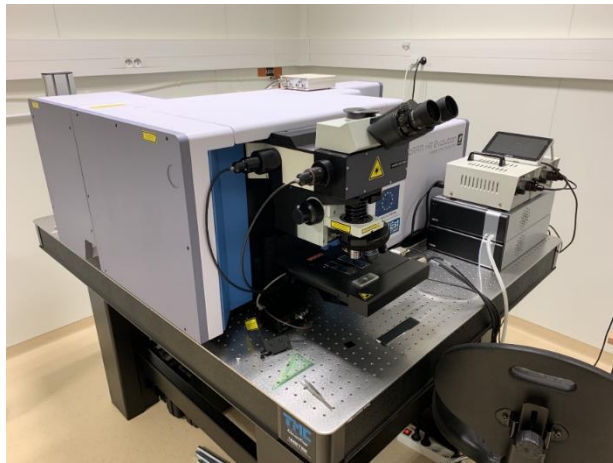

- SiC strong interatomic bonding
→ favourable for Raman scattering
- Raman very sensitive to crystal structure, polytype, defects, doping ...
- PL also possible (from 320 to 1000nm)

μ-Raman Microscopy

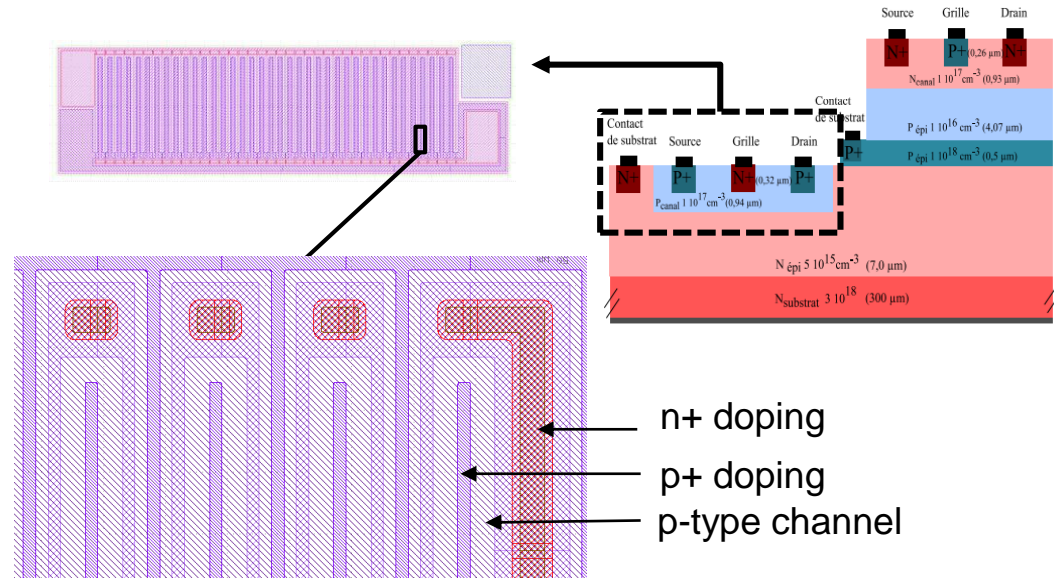
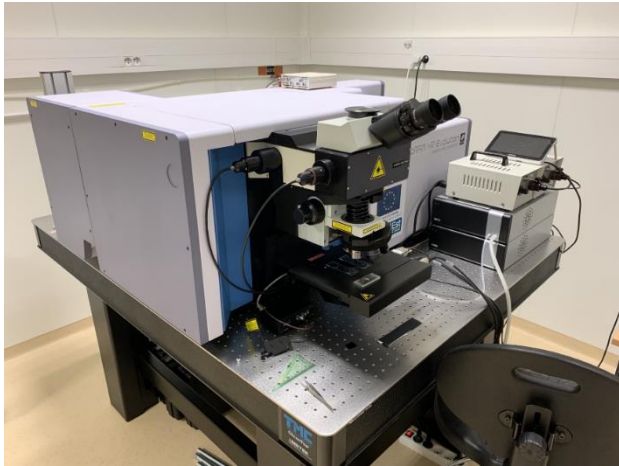

μ Raman scanning (in UV 325 nm)

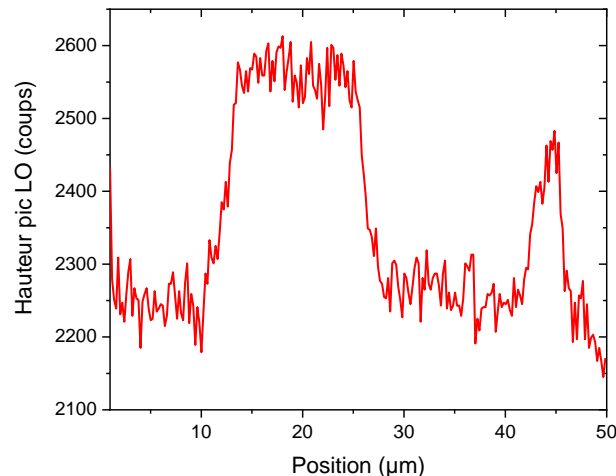

- p and n+ are identified from n- layers
 - Complementary results compared to KPFM

- SiC strong interatomic bonding
 → favourable for Raman scattering diffraction
- Raman very sensitive to crystal structure, polytype, defects, doping ...
- PL also possible (from 320 to 1000nm)

Implementation of a 100/150 mm SiC technological fabrication line

1) Progressively starting with little runs (end 2018 and beginning of 2019)

- to test the feasibility based on our past experience and by training if necessary on new equipment,
- technology transfer : Nanolyon (Lyon cleanroom 50mm) -> ESIEE/Nano'Mat,
- with the support of two engineering teams from the two research structures,
- high number of trips/missions -> ESIEE Paris and also Lyon, Strasbourg, ISL...

➔ Step validated during 2019 – industrial project NEDSiC (Magdala society)

- neutron detectors in SiC,
- PiN structure with a large SCR (HPSI substrates),
- high precision (revers current extremely low – fA)
- 2 runs delivered,
- process-flow defined with critical technological steps validated for the future SiC projects.

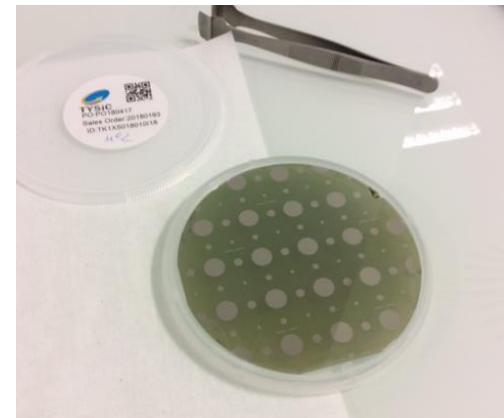

SiC 100 mm wafer processed:

A project set up and managed with the support of the UTT (50 k€)

Implementation of a 100/150 mm SiC technological fabrication line

2) Shift to larger and more numerous projects

ANR HV-PhotoSW - High Voltage Photo-Switches

- CE05 (Une énergie durable, propre, sure et efficace)
- Ampère CNRS - Institut franco-allemand de recherches de Saint-Louis -NOVASIC S.A.
- 2019 – 2023 – 465 k€

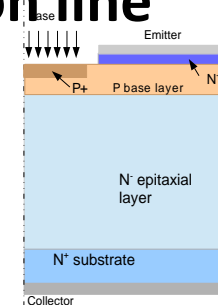

ESACAT 2 – Cold cathodes fabrication on SiC

- industrial project supported by Thales

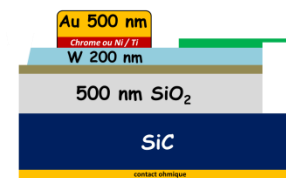

ANR MUS²IC - Monolithic Ultimate Switching cell in Silicon Carbide

- CE05 (Une énergie durable, propre, sure et efficace)
- LAPLACE, LAAS, L2n, AMPERE
- 2022 - 2026 – 504 k€

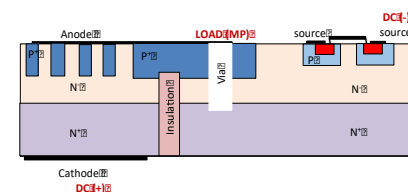

Fabrication of LED (white and with color centers) in SiC

- SATT SAYENS, CNRS
- 2 patents: **FR2201067** and **FR2201064**



KRASiC – Région GE – ph-d student project Enora Vuillermet

- engineering of SiC defects (color centers) for luminescent devices

Process-flow HV-Photo SW: 11 mask levels, about one hundred steps

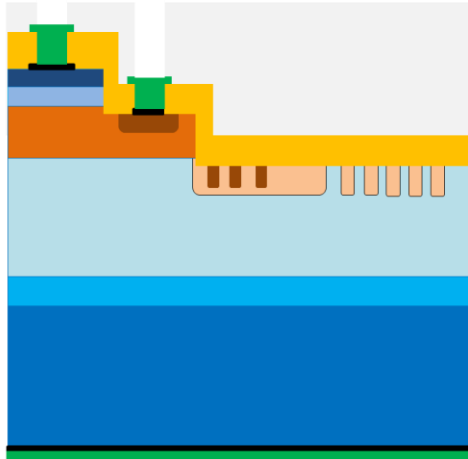

- N++ contact (épi)
- N+ sous-contact (épi)
- P+ base (épi)
- P++ base contact (impl)
- JTE (impl)
- N- (épi)
- N+ buffer (épi)
- N+ substrat
- Métallisation fine
- Surmétallisation
- Passivation 1
- Passivation 2 (polyimide)

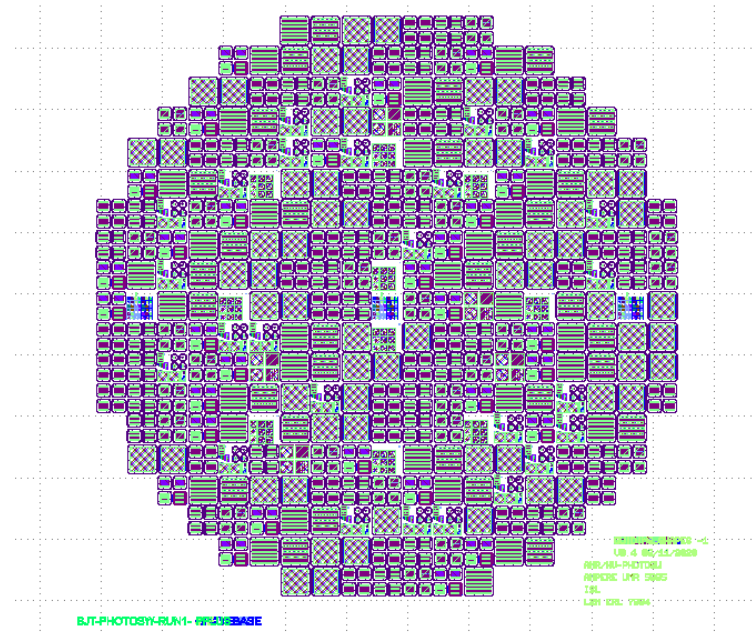

SanoMat JTT	Dépôt couche volatile Gravure SIC en ICP-RIE SF6 - ~2,5µm	Profondeur à valider	1 ^{ère} Litho-gravure Ni (4) Graveur ICP-RIE-SF6	
SIEE	Bains acides (dont Al-etch chaud) Acides (CARO, BHF) Solvants (Acétone IPA) Protection face avant - masque dur Dépôt masque dur (Ni) en pulvérisation cathodique	Retrait masque Nettoyage (optionnel) 1µm	2 ^{ème} Litho-gravure P (1)	
SIEE	Litho masque Niveau 10 (data senders) Résine positive 3µm Alignement Ouverture en humide masque dur	2 ^{ème} Litho-gravure P et éventuellement mes de protection		

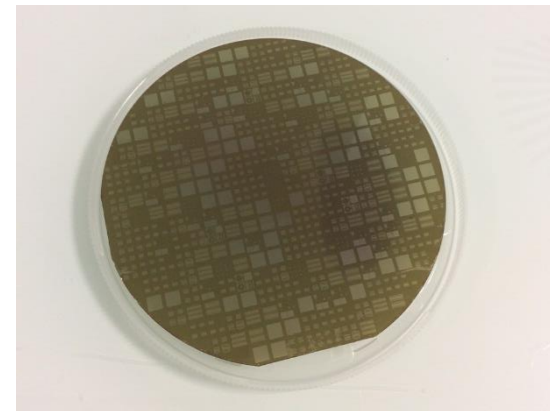



Electrical cahracterizations – 1st run

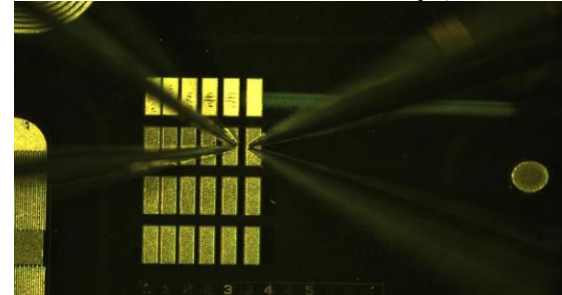
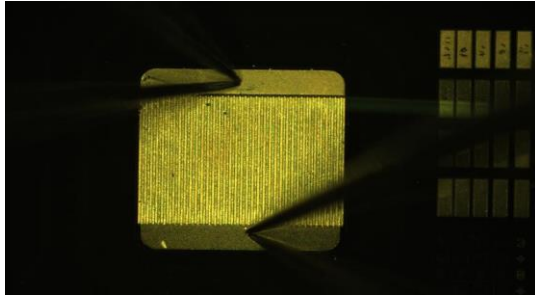

5 mm x 5 mm electrical BJT

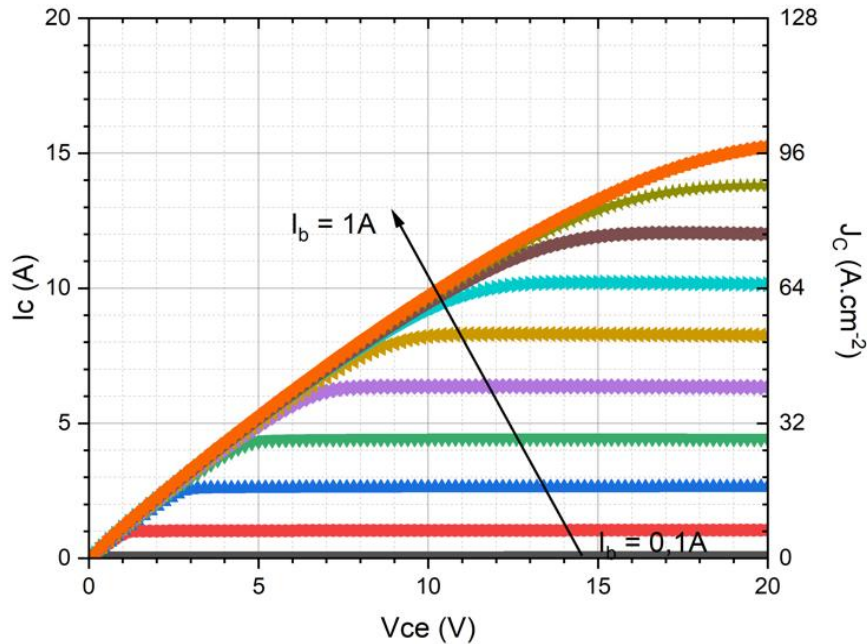

Current gain: 15

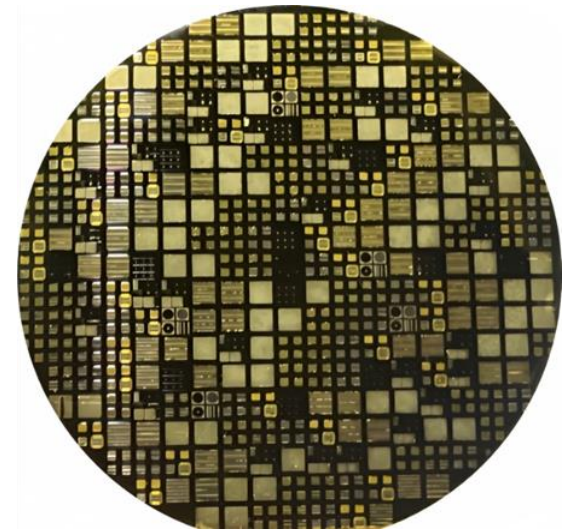

Breakdown voltage: 11kV (the goal was 10kV)

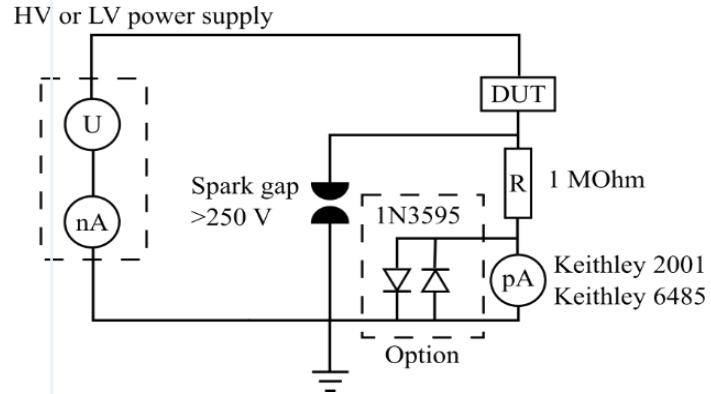

Reverse IV characteristics - open emitter blocking

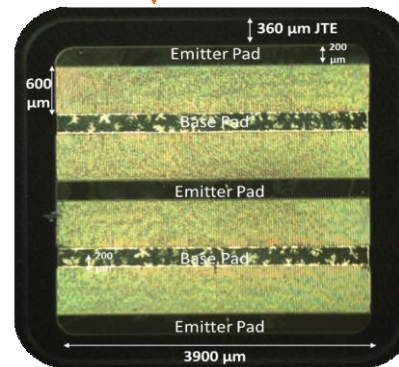
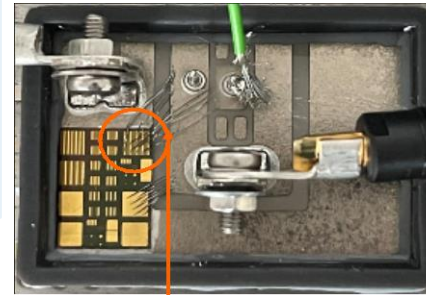
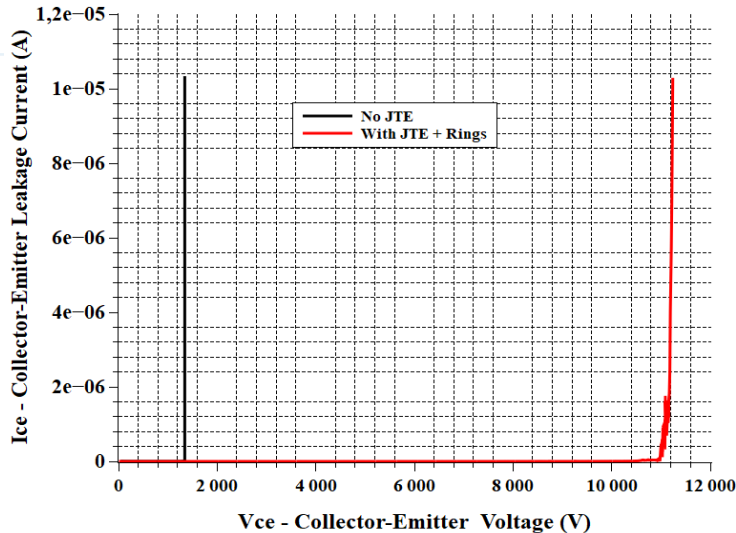

Electroluminescence at high voltage



ANR MUS²IC - Monolithic Ultimate Switching cell in Silicon Carbide

For Ultimate Efficient Power Vertical Integration

Full-SiC Single-Chip Buck and Boost MOSFET-JBS Converters :

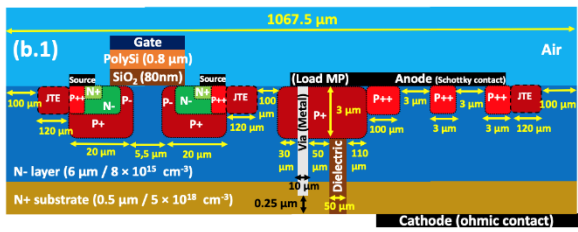
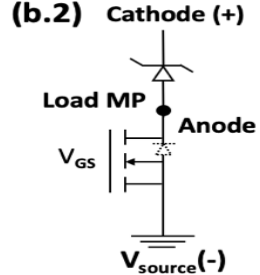
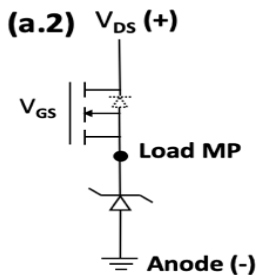
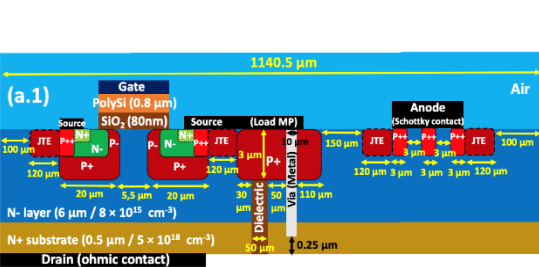

Full-SiC Single-Chip High-Side and Low-Side Dual-Mosfet :

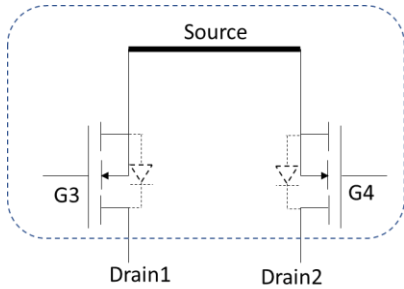
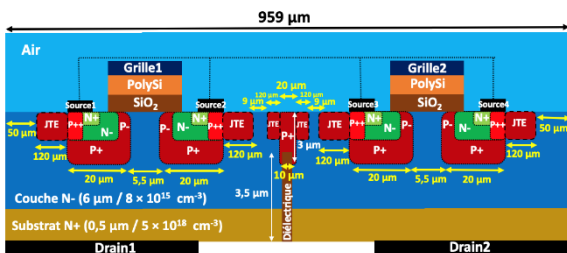

- Technological realization of the deep vertical insulating SiC etched-trench region
 - by both and alternative fluorinated plasma and electrochemical etching
 - same process is need to isolate color centers in quantum nanophotonic cavities