



HAL
open science

Cathodoluminescence study of silicon vacancies color centers generated by ion implantation in 6H-SiC

Enora Marion Vuillermet, R. Haddadi, N. Bercu, L. Ottaviani, L. Giraudet,
M. Lazar

► **To cite this version:**

Enora Marion Vuillermet, R. Haddadi, N. Bercu, L. Ottaviani, L. Giraudet, et al.. Cathodoluminescence study of silicon vacancies color centers generated by ion implantation in 6H-SiC. 2023 International semiconductor conference (CAS) - 46th edition, NATIONAL INSTITUTE FOR RESEARCH AND DEVELOPMENT IN MICROTECHNOLOGIES - IMT Bucharest; IEEE – Electron Devices Society, Oct 2023, Sinaia (Romania), Romania. pp.135-138, 10.1109/CAS59036.2023.10303651 . hal-04304522

HAL Id: hal-04304522

<https://hal.science/hal-04304522>

Submitted on 28 Nov 2023

HAL is a multi-disciplinary open access archive for the deposit and dissemination of scientific research documents, whether they are published or not. The documents may come from teaching and research institutions in France or abroad, or from public or private research centers.

L'archive ouverte pluridisciplinaire **HAL**, est destinée au dépôt et à la diffusion de documents scientifiques de niveau recherche, publiés ou non, émanant des établissements d'enseignement et de recherche français ou étrangers, des laboratoires publics ou privés.

Cathodoluminescence study of silicon vacancies color centers generated by ion implantation in 6H-SiC

E. Vuillermet^{*}, R. Haddadi^{**}, N. Bercu^{**}, L. Ottaviani^{***}, L. Giraudet^{**} and M. Lazar^{*}

^{*}L2n, CNRS EMR 7004, UTT, France

^{**}LRN, EA4682, University of Reims Champagne Ardenne, Reims, France

^{***}Aix-Marseille Univ, Université de Toulon, CNRS, IM2NP, Marseille, France

enora.vuillermet@utt.fr

Supervisor: Mihai Lazar

What is silicon carbide ?

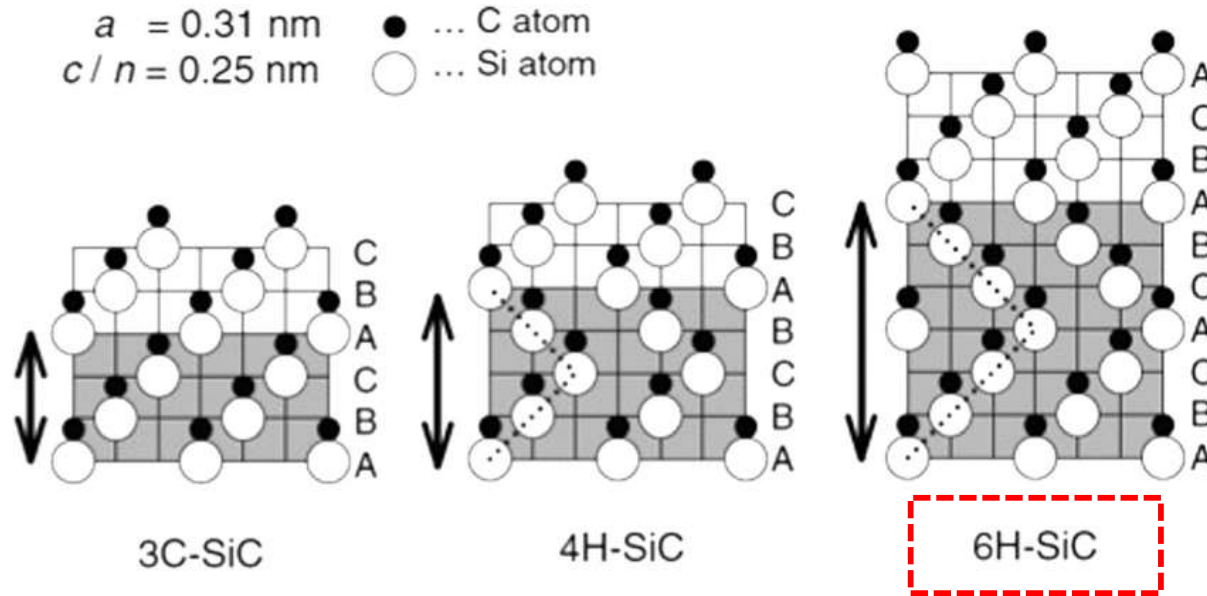

K. Ashida et al, JVSTB. 33 (2015)

- Wide bandgap semiconductor with multiple polytypes
- n and p-type doping possible

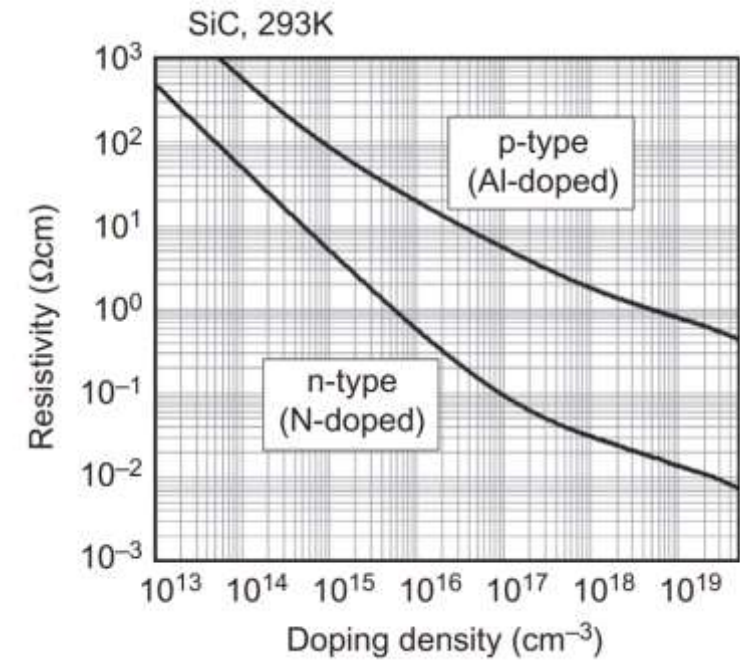
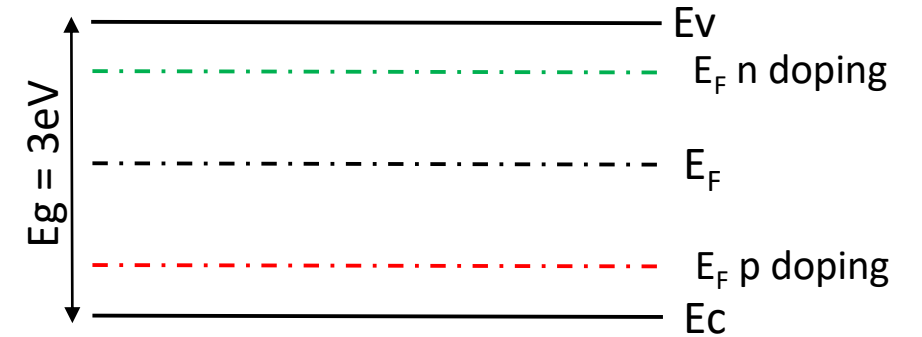

T. Kimoto, *SiC materials properties*, **WDB Semiconductor Power Devices**, Woodhead Publishing (2019)

What is silicon carbide ?

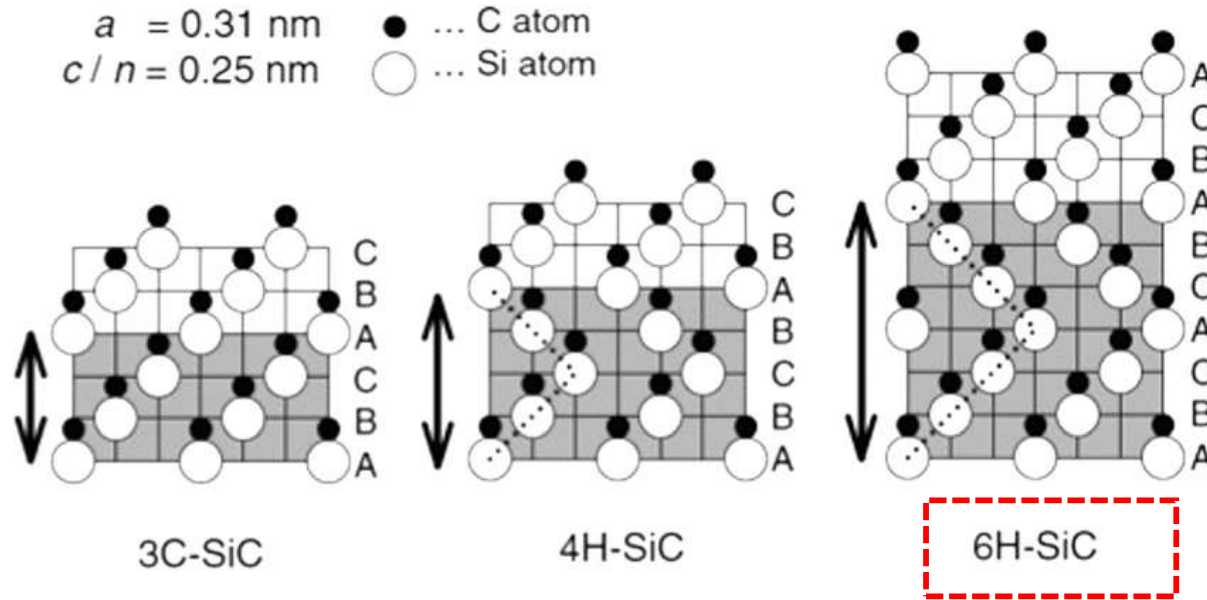

K. Ashida et al, JVSTB. 33 (2015)

- Wide bandgap semiconductor with multiple polytypes
- n and p-type doping possible
- High thermal conductivity and temperature resistance
- High technological maturity

Applications in high-voltage, high-temperature power devices

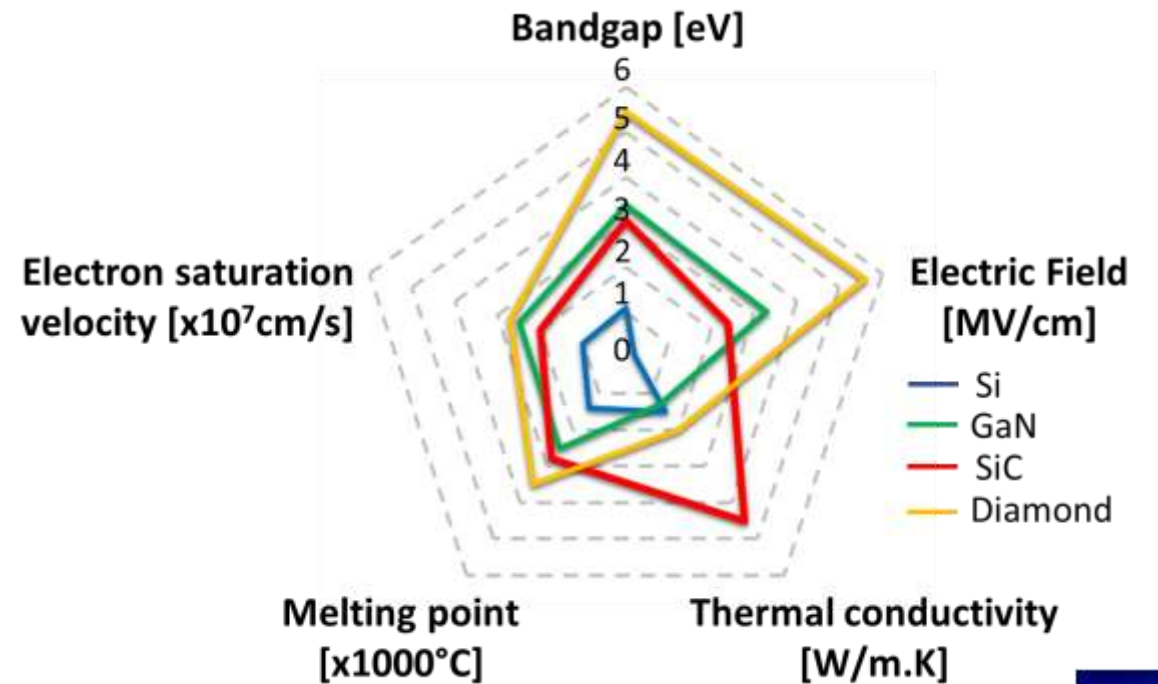
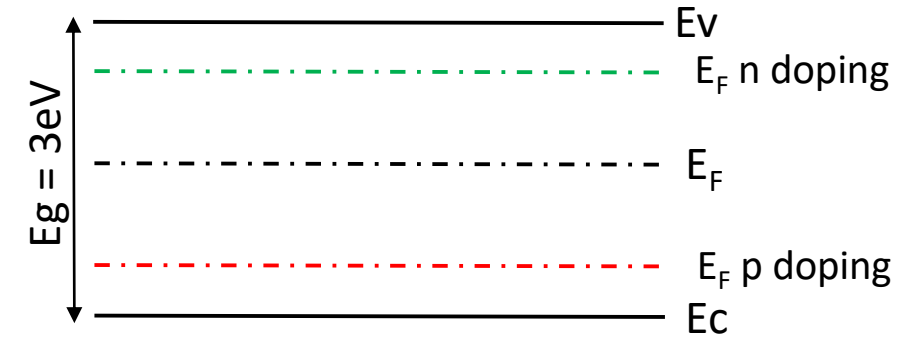

SiC as a photonic device

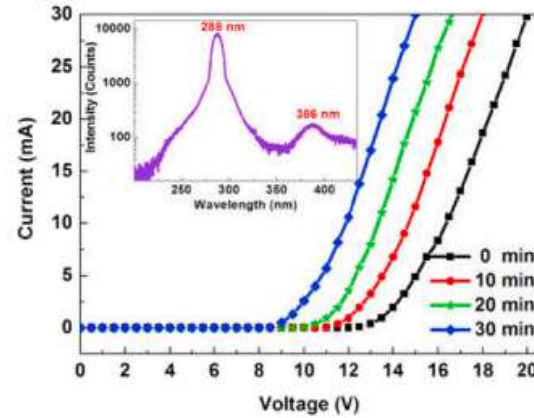
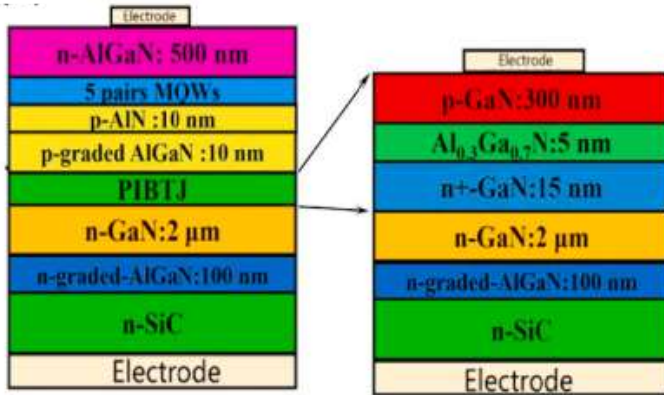

Hongwei Liang *et al*, *Jpn. J. Appl. Phys.* 55 (2016)

Vertical UV LEDs on SiC



Single photon emitter
p-n diode



Color centers

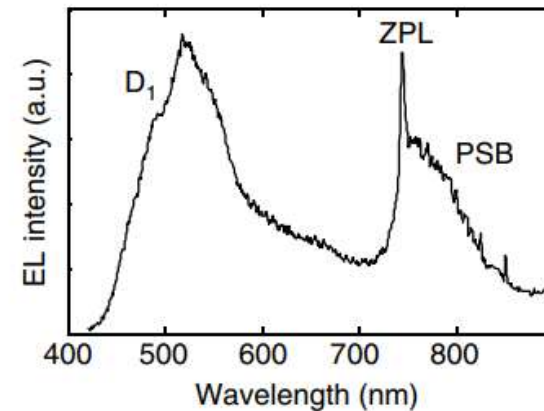

A. Lohrmann *et al*, *Nat. Commun.* (2015)

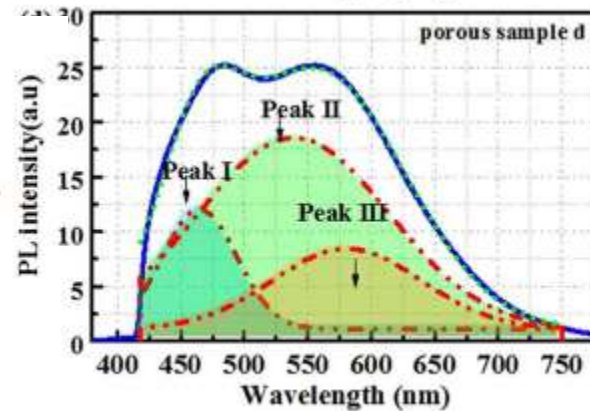
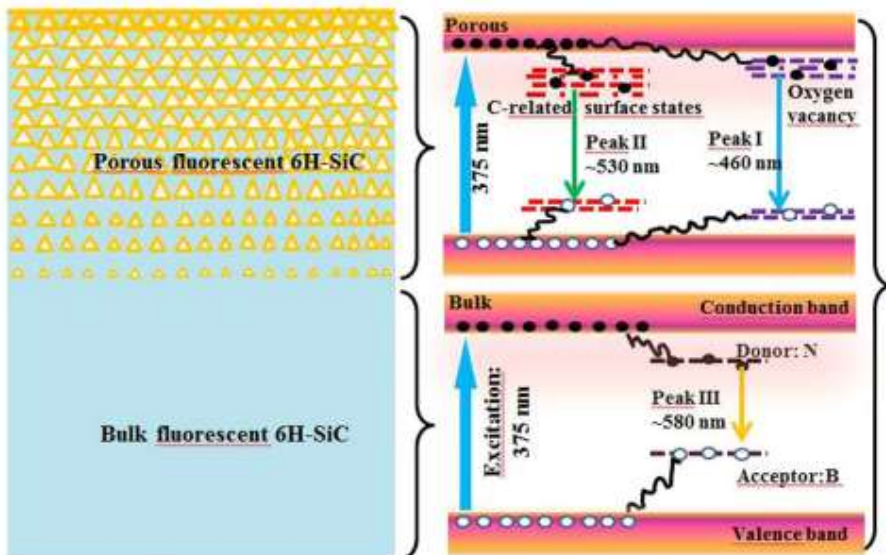

Fluorescent SiC

Weifang Lu *et al*, *Scientific Report.* 7 (2017)

Color centers in SiC

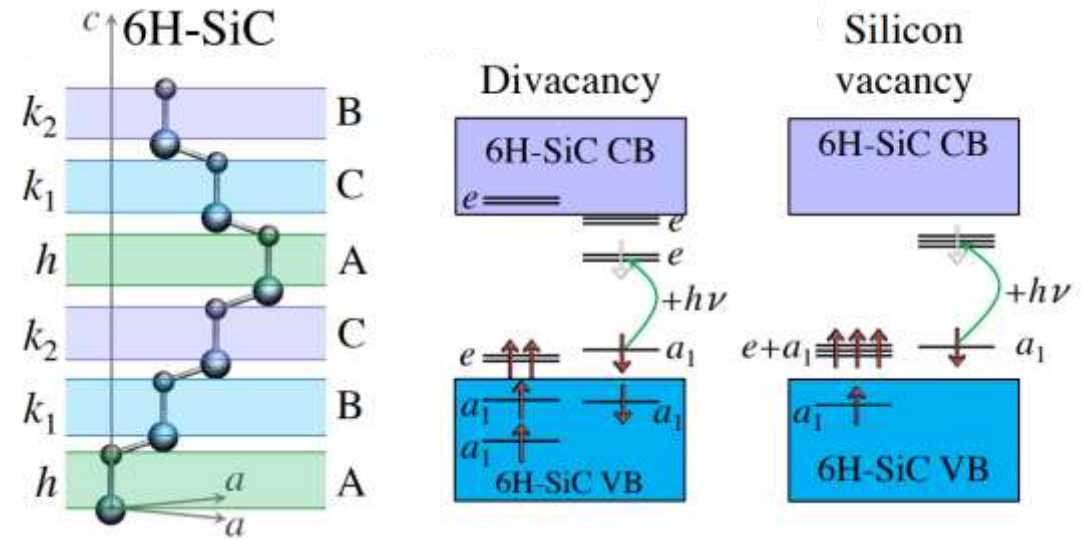
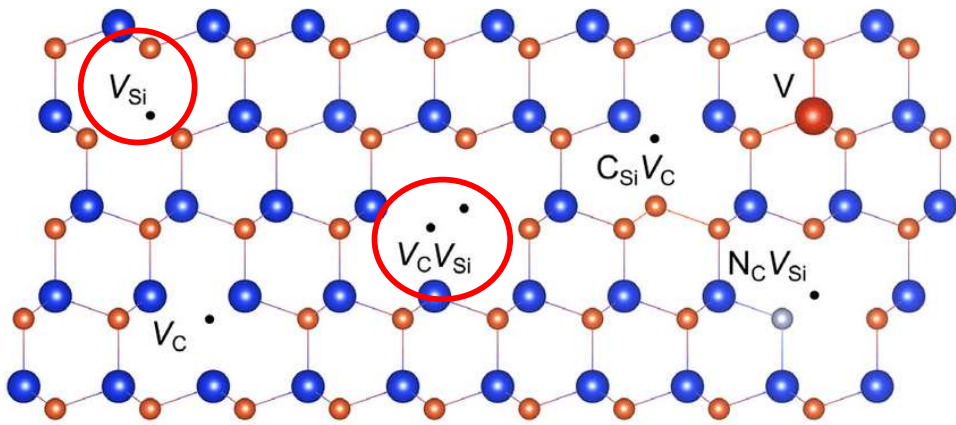

M.E. Bathen and L. Vines, *Advanced Quantum Tech.* (2021)

- Point defects within the lattice
- Single photon sources : qubits
- Emission of visible light in diamond
- Emission of **NIR light** in SiC

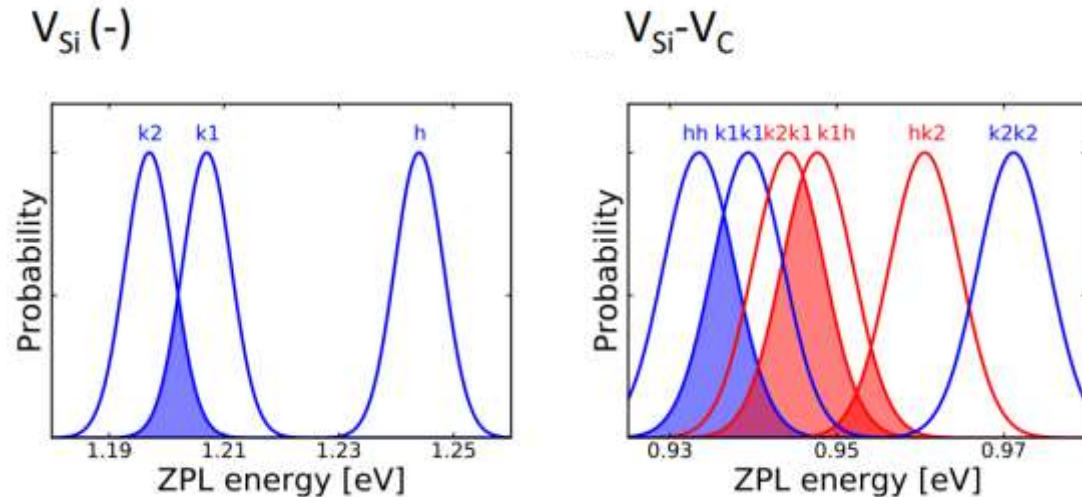

J. Davidsson et al, *Applied Physics Letters.* (2019)

High technological maturity of SiC

Color centers in SiC

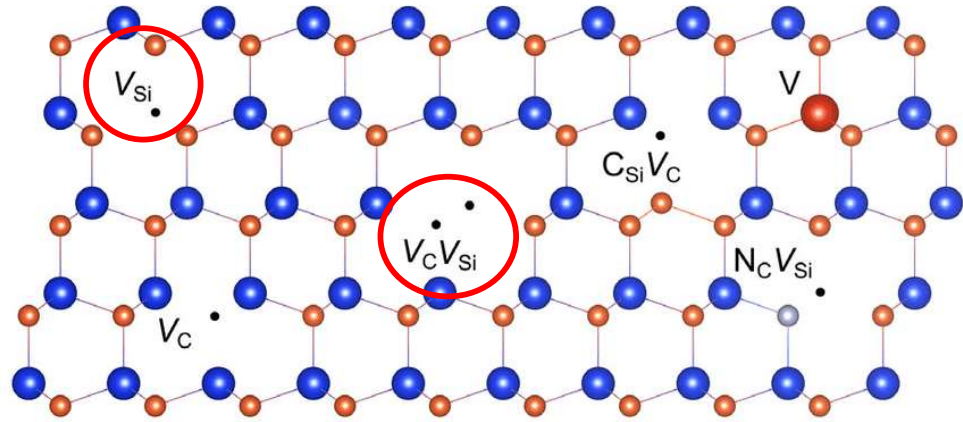

M.E. Bathan and L. Vines, *Advanced Quantum Tech.* (2021)

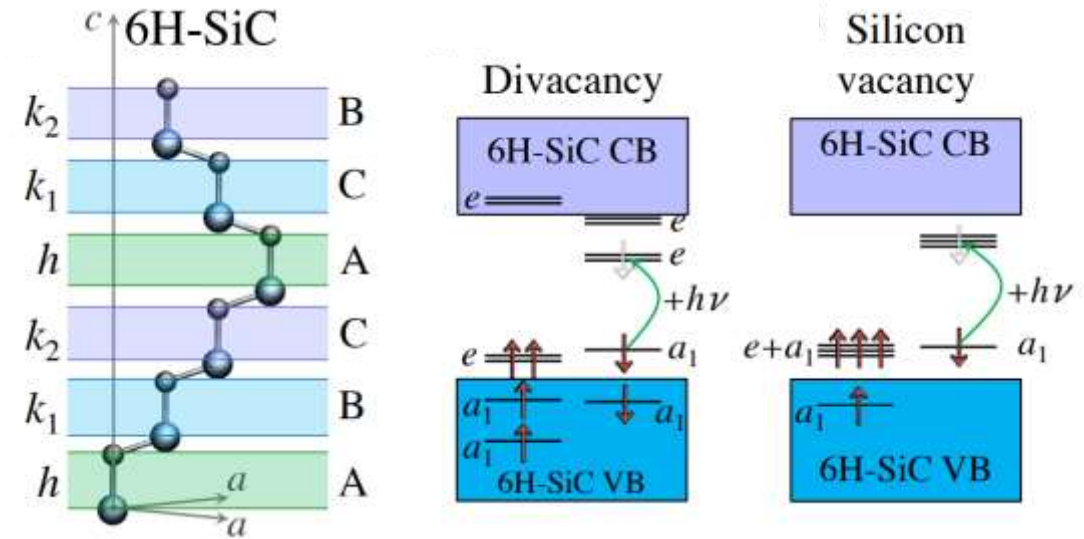

$V_{Si}(-)$

$V_{Si}-V_C$

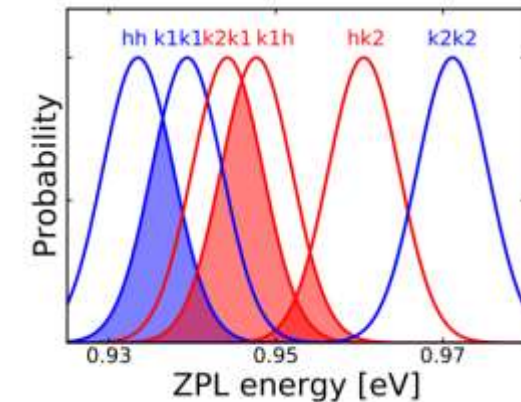
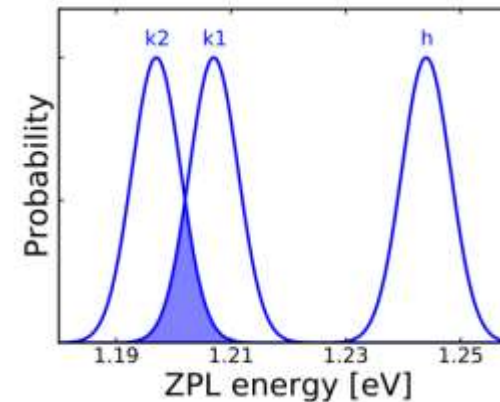

Objective: To study the influence of ion implantation parameters on the generation of color centers in 6H-SiC samples

Application : To create a photonic device with these point defects → emission of NIR light

J. Davidsson et al, *Applied Physics Letters.* (2019)



Generation of the color centers



Crystallinity of the samples



Detection of the color centers



Generation of the color centers



Crystallinity of the samples



Detection of the color centers

Ion implantation

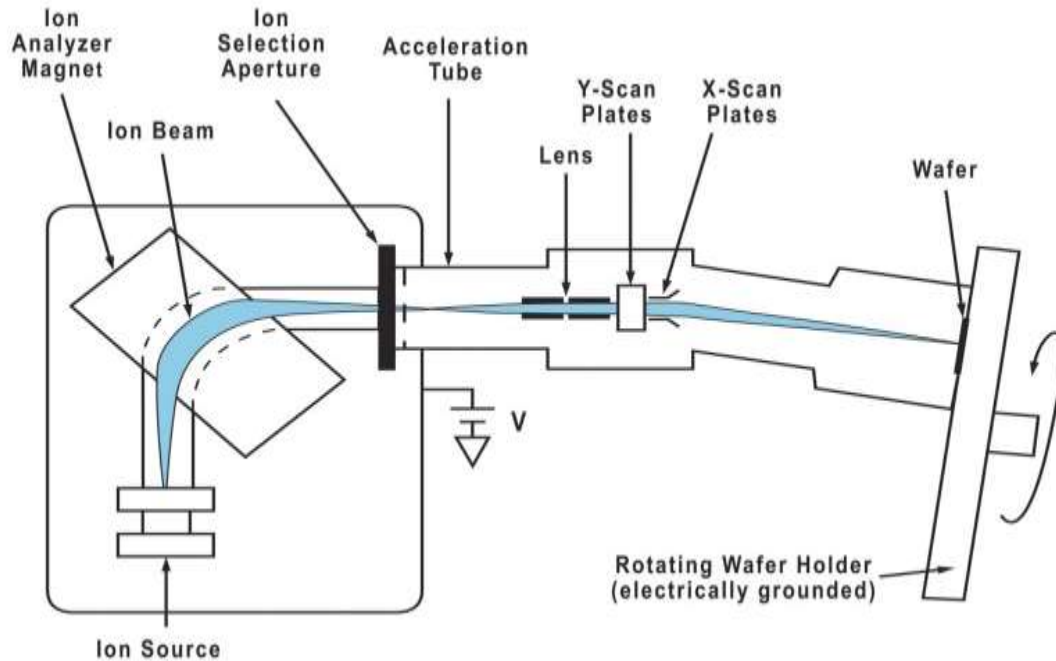

Ion implanter scheme

MKS, <https://www.mks.com/n/ion-implantation>

| Samples | Dopant | T [°C] | E _{max} [keV] | D _T [cm ⁻²] |
|---------|--------|--------|------------------------|------------------------------------|
| S1 | Al | 300 | 25 → 300 | 1.0×10 ¹⁴ |
| S2 | Al | 25 | 25 → 300 | 1.0×10 ¹⁴ |
| S3 | Al | 300 | 300 → 25 | 1.0×10 ¹⁴ |
| S4 | Al | 25 | 300 → 25 | 1.0×10 ¹⁴ |
| S5 | B | 300 | 340 → 20 | 1.39×10 ¹³ |
| S6 | B | 25 | 340 → 20 | 1.39×10 ¹³ |
| S7 | NA | NA | NA | NA |

- Simulations close to the experimental results
- Generation of color centers in **localized and large areas**
- **Ion implantation of Al and B in 6H-SiC**
- Energy of implantation fixes the point defects depth
- Order of implantations can change the defects distribution
- Limited damage in the SiC lattice with well-controlled parameters : dose and temperature

Silicon vacancy and dopant profiles

Monte Carlo simulations: I²SiC software

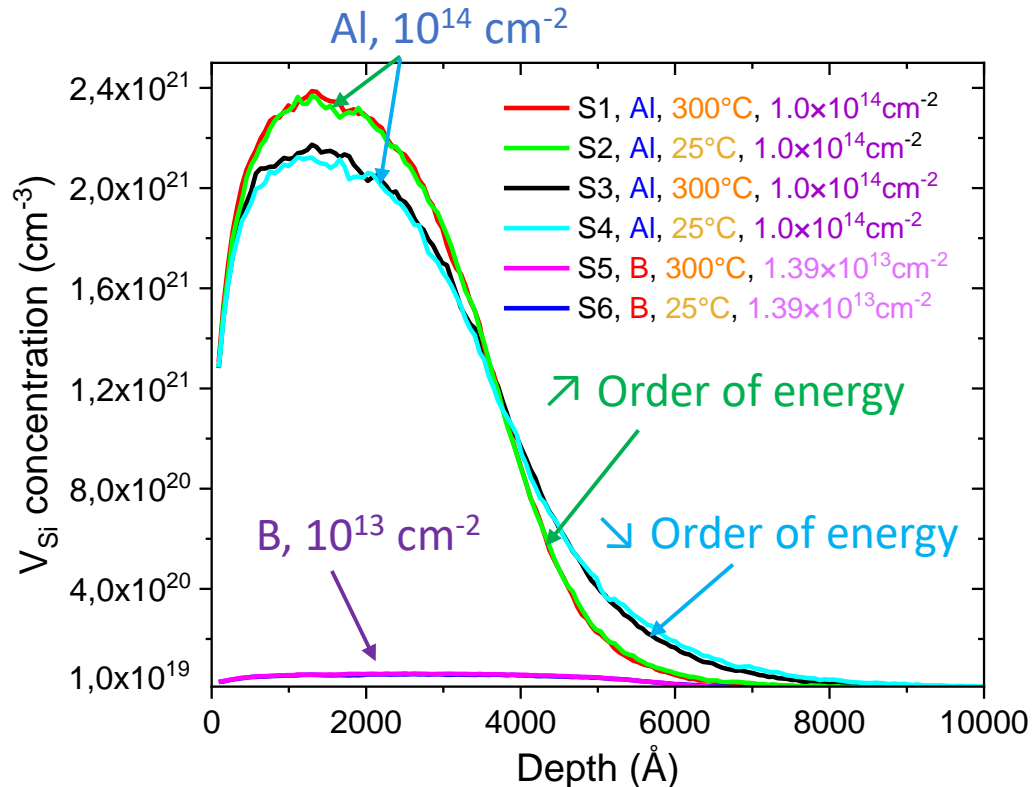

Simulated silicon vacancy profiles

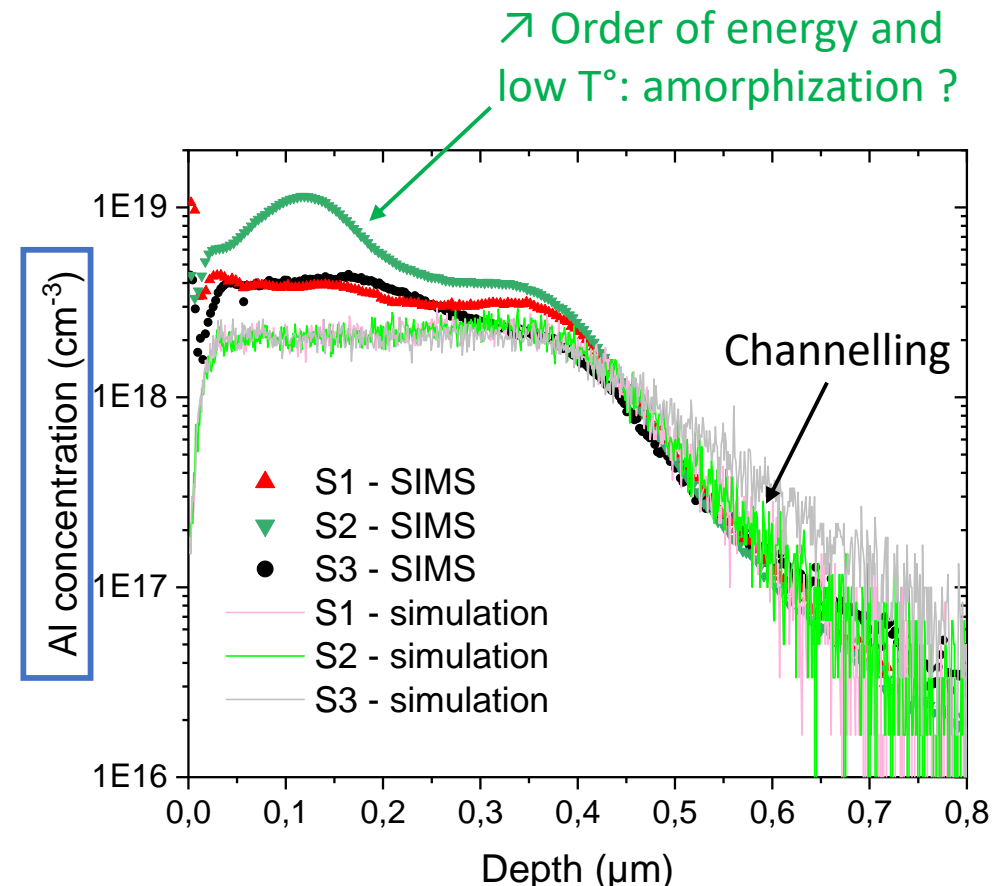

Simulated and experimental dopant profiles

➤ The order of implantations and the dose impact the distribution of V_{Si}

➤ **Difference** between simulations and experimental results (SIMS)

GENERATION OF COLOR CENTERS IN 6H-SiC

SIMS measurements



SIMS IMS7F-CAMECA – GEMAC
(François Jomard)

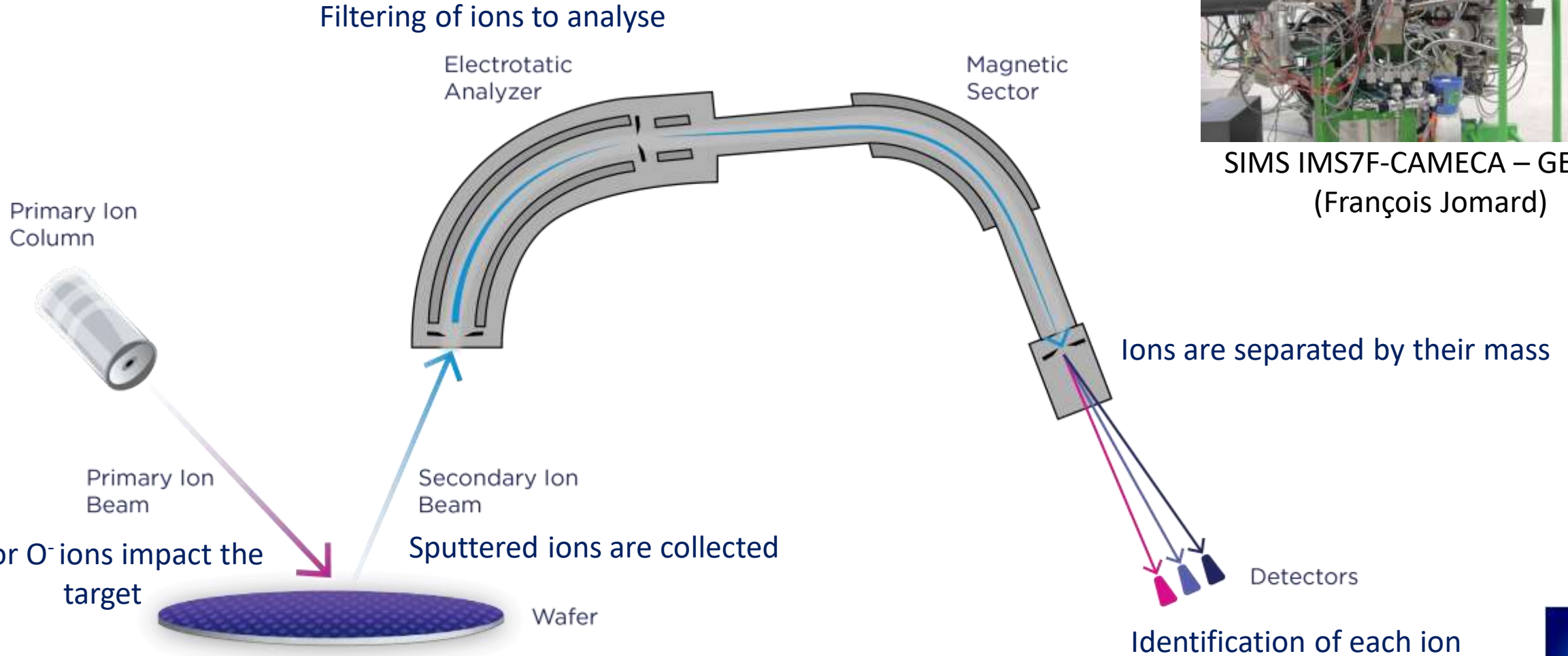



Generation of the color centers



Crystallinity of the samples



Detection of the color centers

Raman measurements

$\lambda_{exc} = 325\text{nm}$, obj x40, 1800 gr/mm

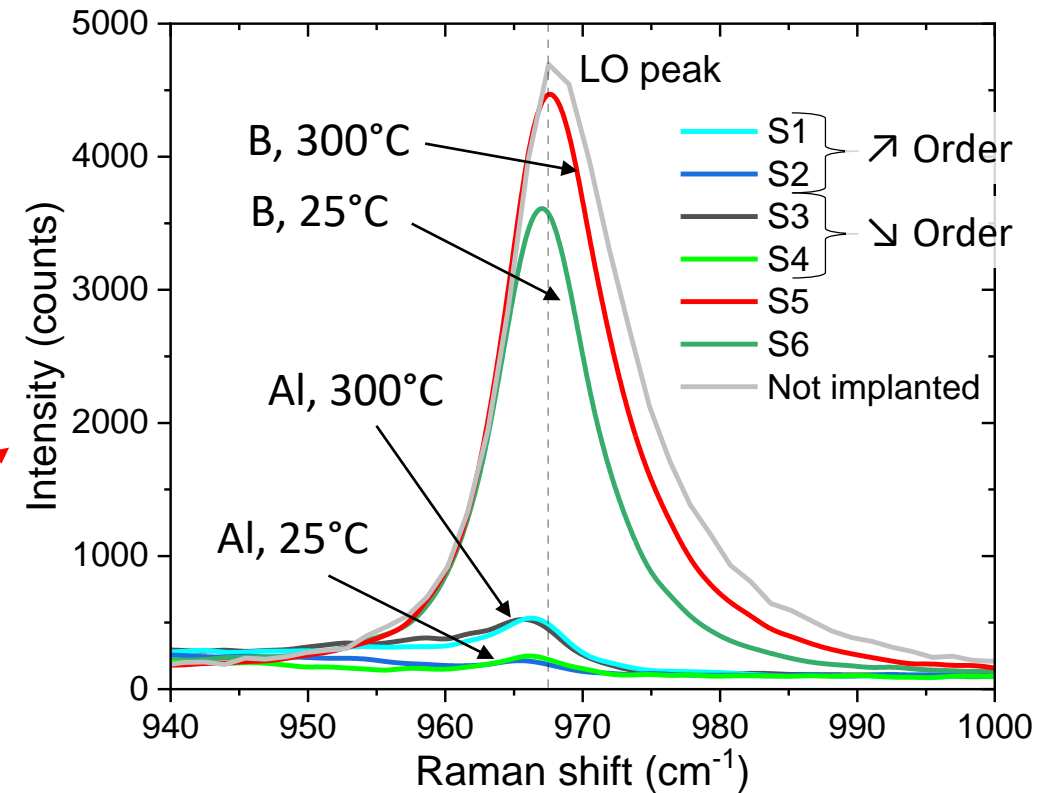
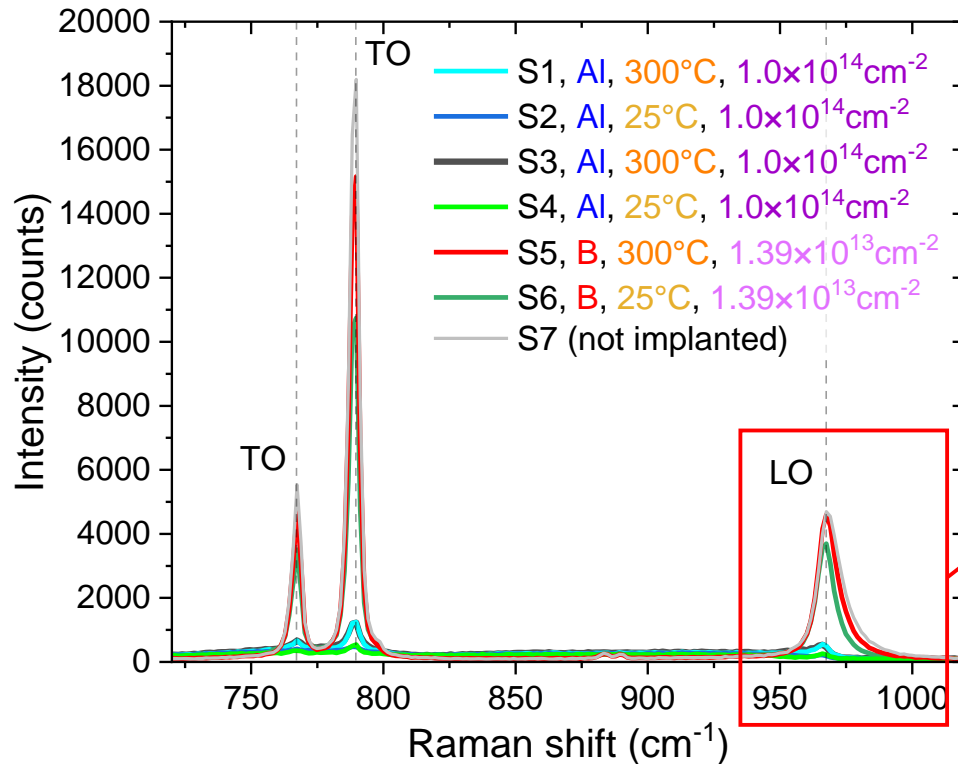

↗ sample damage at the surface with implantations of high doses at low temperatures
Contrary to simulations, temperature affects the lattice damage but not the order of implantations

RBS/C measurements

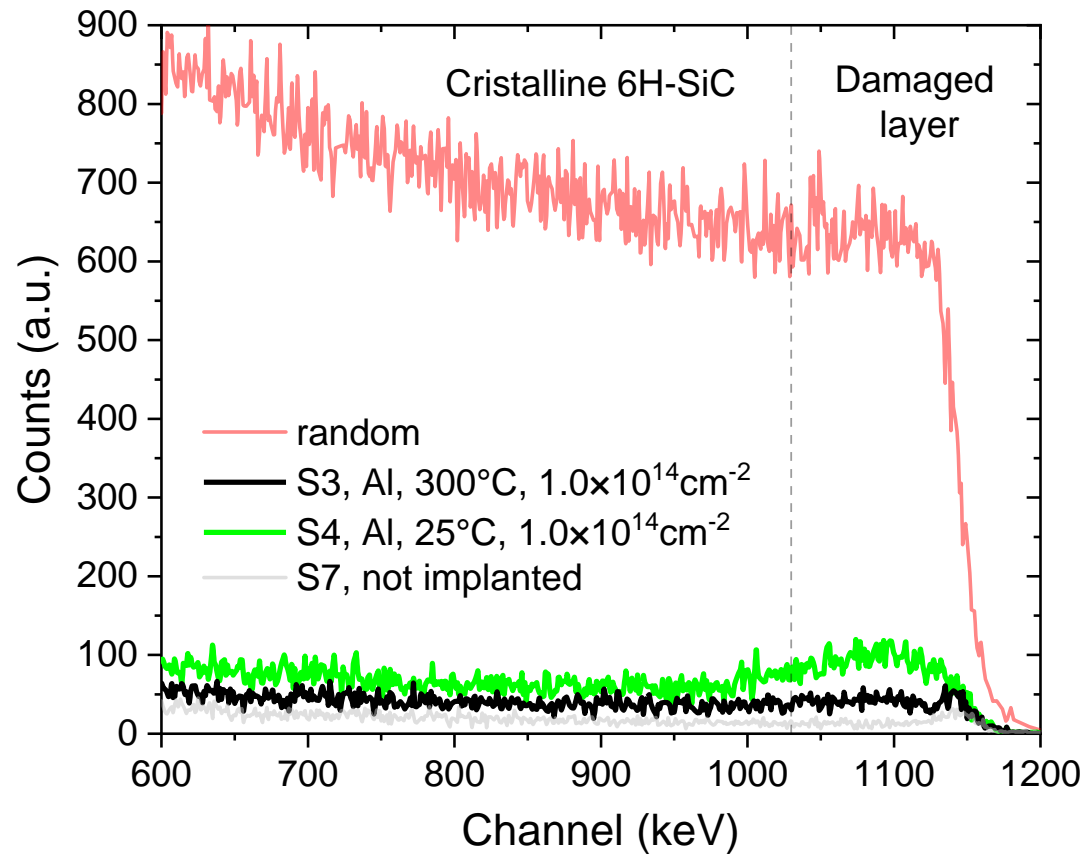

- Slight samples' surface damage
- Far from the amorphization threshold
- Less sensible to damage compared to Raman
- Point defects can still be observed



Generation of the color centers



Crystallinity of the samples



Detection of the color centers

Cathodoluminescence

- Realized at **80K** (PL at RT)
- Measurements before and after annealing at **900°C for 15min**
- Good sensibility of the camera until **1000nm**

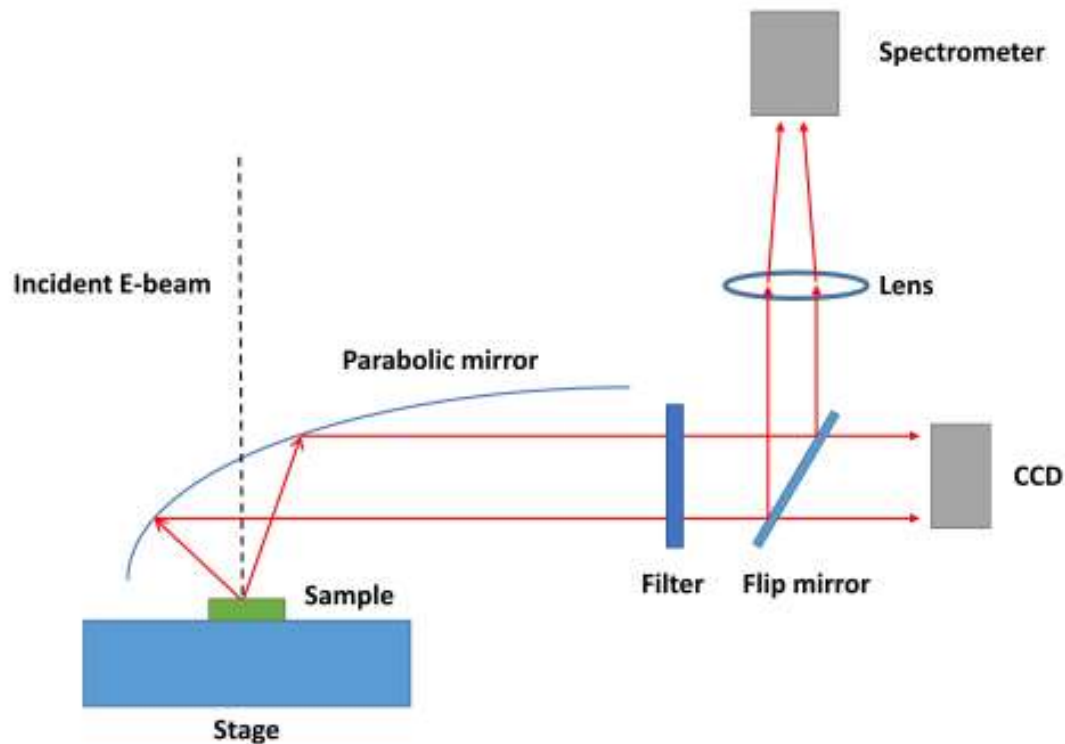

Semicond. Spectro. Devices. <https://ssd.phys.strath.ac.uk/>



DETECTION OF THE COLOR CENTERS

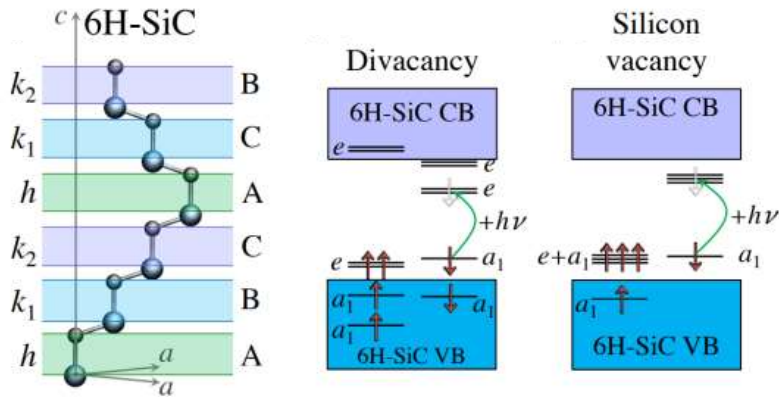

- **Silicon vacancy V_{Si}** : present before and after annealing at 900°C, \searrow of phonon side-bands after annealing
- V_{Si} changes of **preferential configuration** after annealing $\rightarrow V3$ to $V1$
- **Divacancy $V_{Si}V_C$** : appears after annealing at 900°C for 15min \rightarrow we approach the **telecom wavelength**
- 9 $V_{Si}V_C$ configurations possible: ZPL not observed yet for three of them

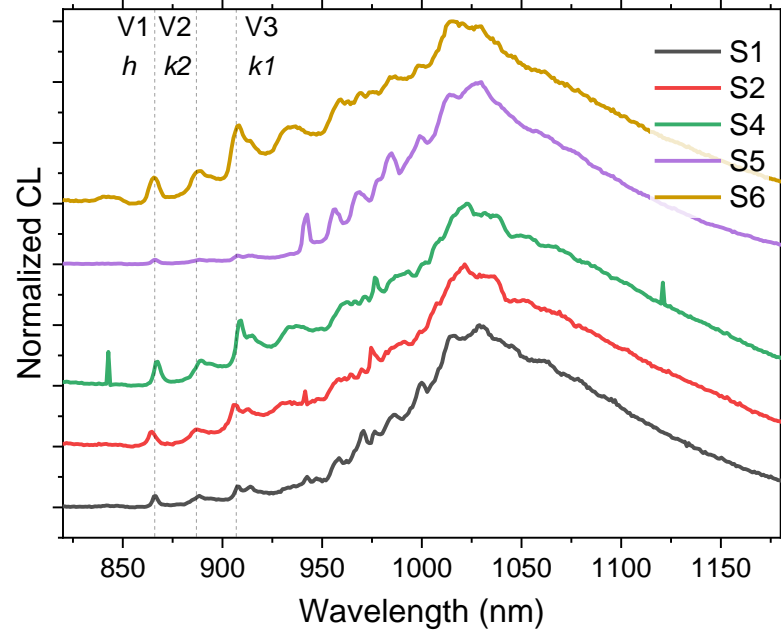

BEFORE ANNEALING

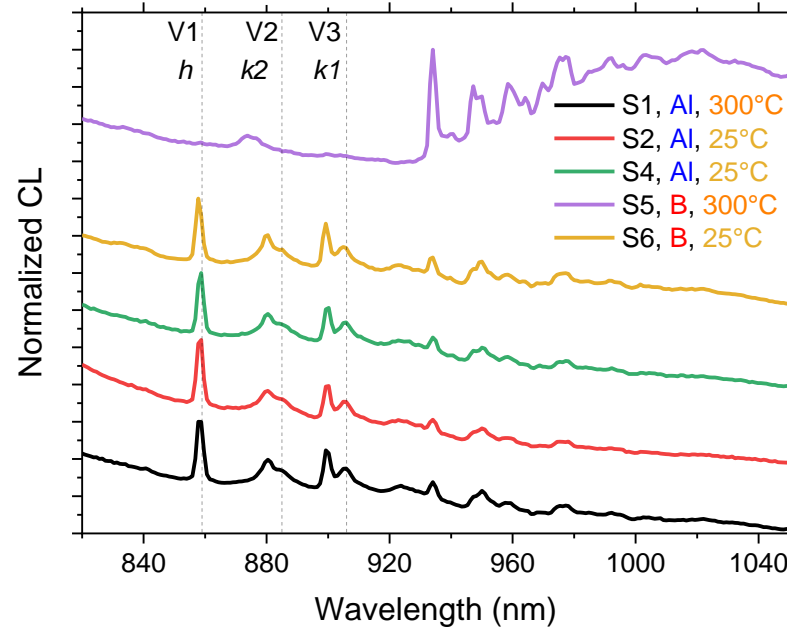

AFTER ANNEALING

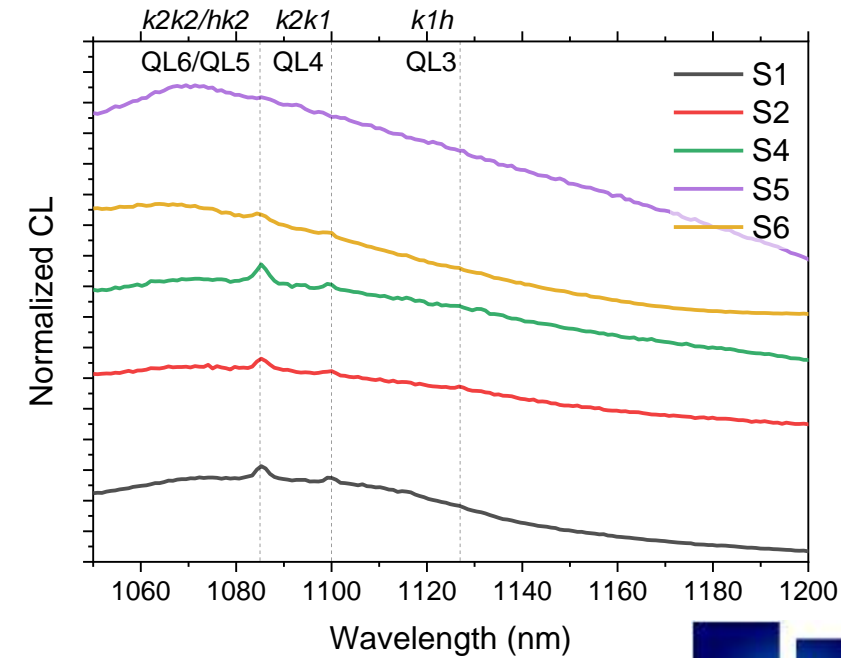

Silicon vacancy evolution

Before annealing

- More defects for implantation of Al (higher dose) at low temperature with decreasing order of implantations
- V3 configuration favored (k1 site)

After annealing

- **Silicon Vacancies**
 - V1 configuration favored (h site)
 - More defects for implantation of boron at low temperature → high diffusion of B in SiC through VSi
- **Divacancies $V_{Si}V_C$**
 - Weak signal of QL3 to QL5/QL6 defects and no signal of QL1 and QL2
 - No divacancies for S5 → not enough vacancies

BEFORE ANNEALING

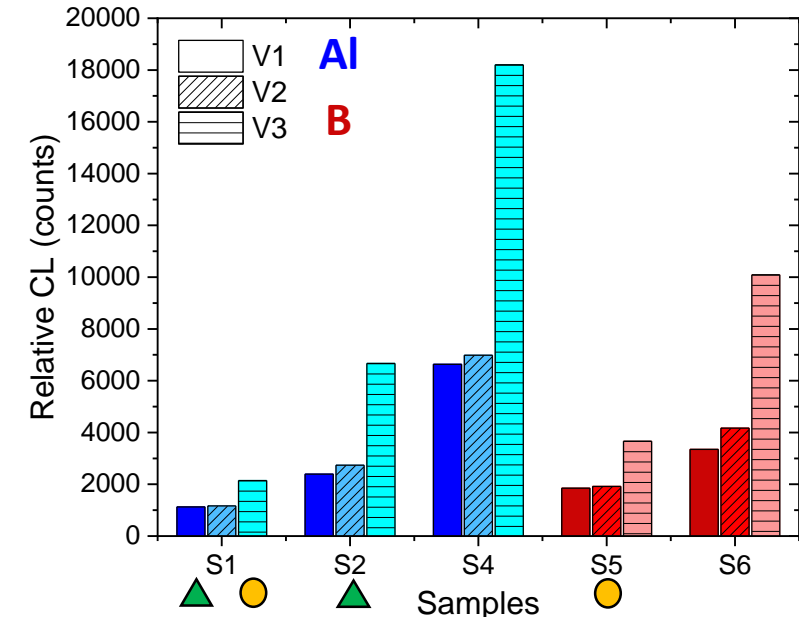

AFTER ANNEALING

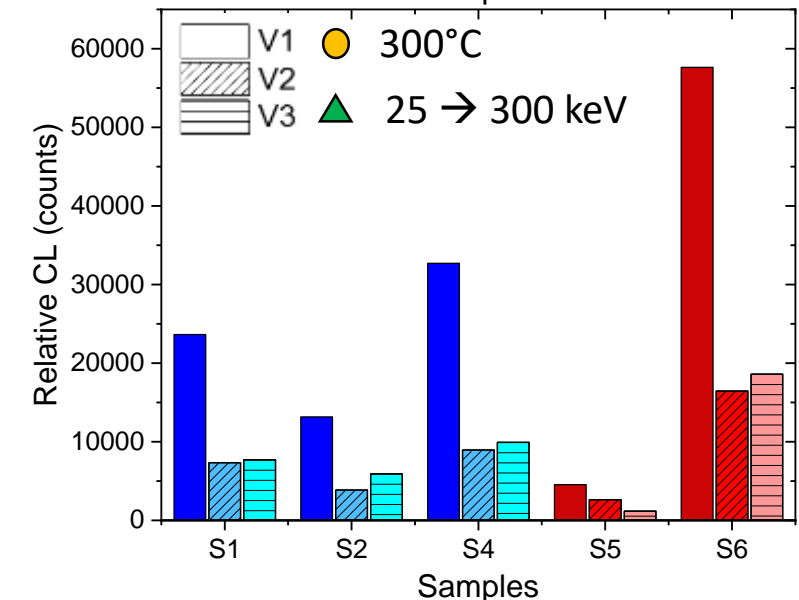

Conclusion

- Color centers are generated by ion implantations of Al and B followed by annealing at 900°C
- Implantations of higher doses at low temperatures result in a loss of crystallinity at the sample surface → the amorphization threshold is not reached
- V_{Si} appears directly after ion implantation: transition from V3 to V1 configuration after annealing.
- Annealing leads to the high diffusion of boron in SiC → more V_{Si}
- $V_{Si}V_C$ appears after annealing at 900°C for 15min → closer to the telecom wavelength than V_{Si} + longer spin coherence time

Perspectives

- CCD camera with good NIR sensibility + PL setup in NIR
- Integration of the point defects in a photonic device

Thank you !