



HAL
open science

Sea Water Air Conditioning (SWAC): A Resilient and Sustainable Cooling Solution for hot and humid climates -Energy Performance and Numerical Modeling

Kanhan Sanjivy, Olivier Marc, Franck Lucas

► To cite this version:

Kanhan Sanjivy, Olivier Marc, Franck Lucas. Sea Water Air Conditioning (SWAC): A Resilient and Sustainable Cooling Solution for hot and humid climates -Energy Performance and Numerical Modeling. 43rd AIVC Conference, Oct 2023, Copenhagen, Denmark. hal-04301115

HAL Id: hal-04301115

<https://hal.science/hal-04301115>

Submitted on 22 Nov 2023

HAL is a multi-disciplinary open access archive for the deposit and dissemination of scientific research documents, whether they are published or not. The documents may come from teaching and research institutions in France or abroad, or from public or private research centers.

L'archive ouverte pluridisciplinaire **HAL**, est destinée au dépôt et à la diffusion de documents scientifiques de niveau recherche, publiés ou non, émanant des établissements d'enseignement et de recherche français ou étrangers, des laboratoires publics ou privés.

Sea Water Air Conditioning (SWAC): A Resilient and Sustainable Cooling Solution for hot and humid climates - Energy Performance and Numerical Modeling

Kanhan Sanjivy^{*1,2}, Olivier Marc³, and Franck Lucas¹

*1 GEPASUD, University of French Polynesia,
Faa'a, French Polynesia
*Corresponding author:
kanhan.sanjivy@doctorant.upf.pf*

*2 French Environment and Energy Management
Agency (ADEME)
20, avenue du Grésillé-
BP 90406 49004 Angers Cedex 01 France*

*3 PIMENT, University of Reunion Island,
Saint-Pierre, La Réunion, France*

ABSTRACT

Sea Water Air Conditioning (SWAC) is a highly efficient alternative to conventional air conditioning that uses deep seawater as a cooling source (Free Cooling). There are three SWAC installations in the world dedicated to cooling production in real-operating conditions, all located in French Polynesia due to its suitable bathymetry for SWAC installations and the high cooling needs of tropical climate. These installations provide cooling for two hotel complexes and a hospital center respectively in Bora Bora, Tetiaroa, and Tahiti.

The efficiency of SWAC has been demonstrated through the experimental assessment of the Tetiaroa installation, which showed that its Coefficient of Performance (COP) can range from 20 to 150, depending on the length of the distribution loop. These experimental results can also allow an accurate validation of a numerical model designed to study various operating scenarios to optimize performance, reduce costs, and expand the technology to areas with less favorable bathymetry than French Polynesia.

The development of such a design tool model is a necessary step for improving future installations and providing an accurate estimation of the capital costs (CAPEX) and operating costs (OPEX), which would greatly accelerate the development of SWAC technology and its visibility worldwide. This article presents a comprehensive examination of the SWAC technology as a resilient cooling solution for tropical climate. It includes a numerical model created using EnergyPlus and Python plugins, along with its experimental validation using Tetiaroa measurements for an operating period of one month.

KEYWORDS

Sea Water Air Conditioning (SWAC); Numerical Model; Experimental Validation; District Cooling (DC)

1 INTRODUCTION

The Intergovernmental Panel on Climate Change (IPCC) has identified an increase in cooling needs as one of the unavoidable consequences of global warming. This tendency is even more significant in tropical territories, where rising temperatures and changing weather patterns are already having a noticeable impact. The International Energy Agency (IEA) report titled “The Future of Cooling” also emphasizes the growing demand for cooling. The report states a need for space cooling expected to triple by 2050 because of combination of factors such as population growth, urbanization, and rising incomes. Such a surge will have a huge impact on energy consumption and greenhouse gas emissions as conventional air conditioning systems are energy-intensive and rely on refrigerants which are potent greenhouse gas (International Energy Agency (IEA) 2018). This article presents SWAC technology as a resilient cooling solution for tropical climates based on over two years of data from Tetiaroa installation. It includes a numerical model created using EnergyPlus and Python plugins, along with its experimental validation using an operating period of one month.

2 EXPERIMENTAL ANALYSIS

2.1 SWAC technology

Sea Water Air Conditioning (SWAC) is a type of free cooling system that uses Deep Ocean Water (DOW) as a cold source to cool buildings thanks to District Cooling (DC). SWAC technology has several advantages:

- Its efficiency is not limited by Carnot efficiency like mechanical refrigeration systems.
- Seawater temperatures remain relatively constant throughout the year.
- SWAC doesn't use any refrigerants like some other Air Conditioning (AC) system.

However, its deployment requires two main conditions, high cooling needs close to the sea and great depths near the coast.

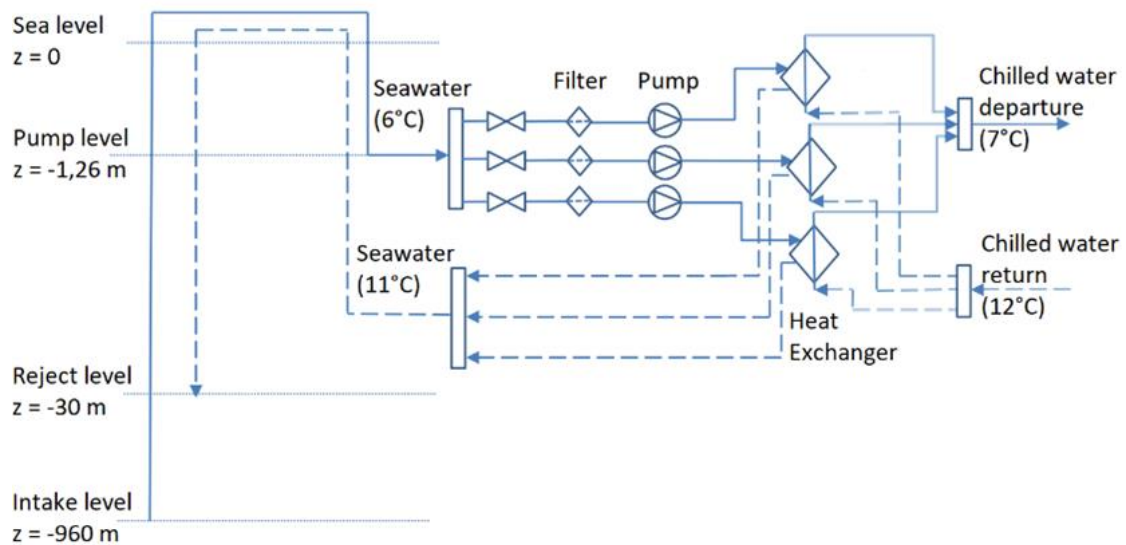

Figure 1: Operating process diagram of SWAC system

The SWAC system is represented above (Figure 1), it includes a drawing and a rejection pipeline. The drawing point is around 960 m depth, and the reject level is at 30 m depth with a technical area located 1.26 m deep in the ground. The technical area contains three pumps and three heat exchangers, combined with a district cooling system with the typical temperature regime 7/12°C. The seawater inlet temperature is about 6°C and 11°C for the return. The environmental impact of a deep seawater discharge was studied for an OTEC installation in Martinique and found that it had a minimal effect on the environment (Giraud, s. d.).

Table 1: Characteristics of SWAC installations in French Polynesia

Location	Year	Drawing pipeline length	Drawing pipeline diameter	Cooling power	Investment cost
Bora Bora	2006	2300 m	400 mm	1.6 MWf	5.5 M€
Tetiaroa	2011	2618 m	368/383 mm	2.4 MWf	10 M€
Tahiti	2022	3800 m	710 mm	6 MWf	30 M€

The SWAC alternative is a relevant solution for insular regions with a high energy cost, especially those having a suitable bathymetry with huge depths close to the shore like French Polynesia. There are three installations providing cooling for two hotel complexes and a hospital center respectively in Bora Bora, Tetiaroa, and Tahiti. Their characteristics are summarized in Table 1 (Sanjivy et al. 2023).

2.2 Experimental data

Experimental data of Tetiaroa SWAC system, including loop temperatures, heat flows, electric pump consumption and Coefficients of Performance (COP) will be presented over a two-year period. Data were averaged on a weekly basis after being processed using the Interquartile Range (IQR) method to remove outliers.

$$IQR = Q_3 - Q_1 \quad (1)$$

$$Q_1 - 1.5 * IQR < \mu < Q_3 + 1.5 * IQR \quad (2)$$

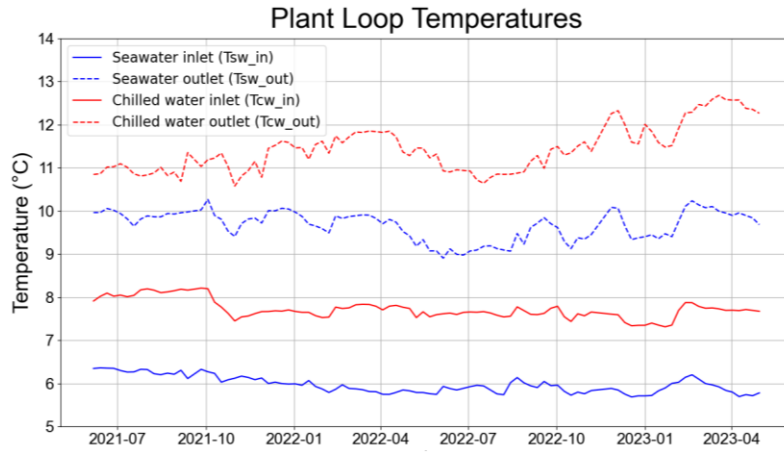

Figure 2: Seawater and chilled water temperatures

Temperatures at the heat exchangers inlet (Tsw_in; Tcw_in) and outlet (Tsw_out; Tcw_out) of each loop are depicted above. The seawater inlet temperature remains between 6 and 6.5°C throughout the year, depending on the primary flow rate. The greater the flow rate, the lower the thermal losses along the drawing pipeline. The chilled water inlet temperature is a constant temperature setpoint which controls the primary flow rate, it is generally fixed between 7.5 and 8°C. Both outlet temperatures vary depending on the building's cooling demand, around 9 and 10°C for the primary loop and 11 and 12°C for the secondary loop.

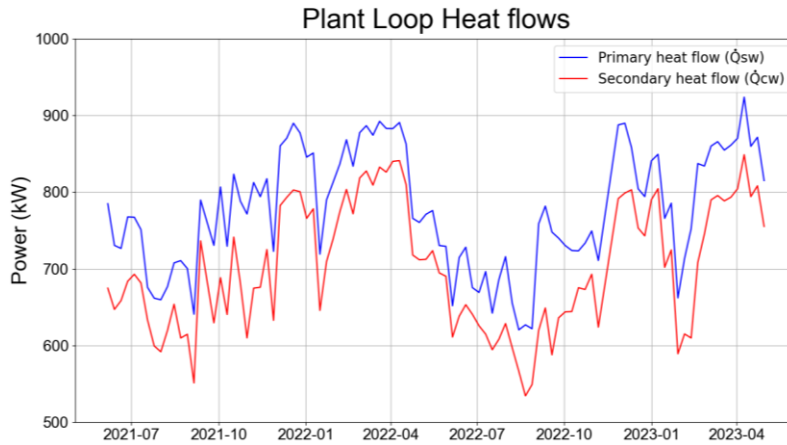

Figure 3: Seawater and chilled water heat flows

The heat flows on each side of the heat exchangers are plotted in Figure 3 and are calculated using (3) and (4).

$$\dot{Q}_{sw} = \rho_{sw} \cdot \dot{V}_{sw} \cdot c_{p_{sw}} \cdot (T_{sw_out} - T_{sw_in}) \quad (3)$$

$$\dot{Q}_{cw} = \rho_{cw} \cdot \dot{V}_{cw} \cdot c_{p_{cw}} \cdot (T_{cw_out} - T_{cw_in}) \quad (4)$$

The cooling demand of the District Cooling (DC) varies between 550 and 850 kW during the year, which is low compared to the nominal installation operation of 2.4 MWf.

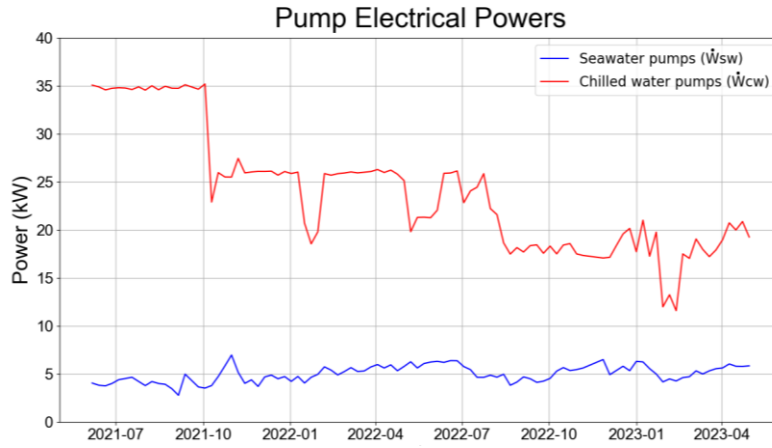

Figure 4: Seawater and chilled water pump electrical powers

The primary pumps consume about 5 kW (Figure 4), the secondary pumps are controlled either by a constant pressure setpoint or manually by the operator.

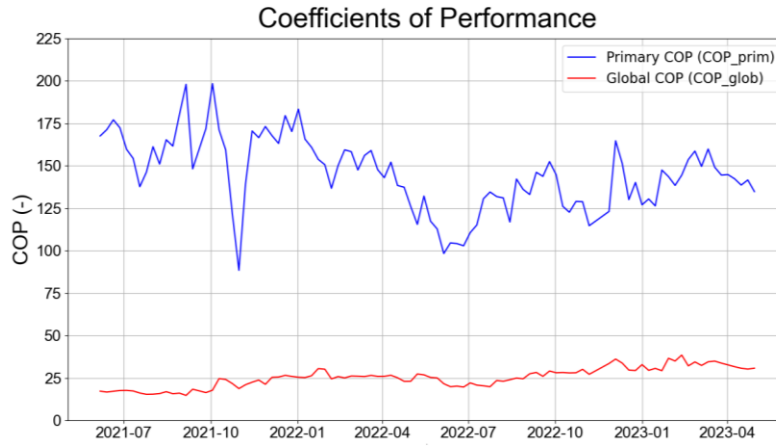

Figure 5: Primary and global COP

Using (5) and (6), two performance indicators have been estimated in Figure 5. The primary COP is excluding the distribution loop in order to compare SWAC performance to centralized AC and is the theoretical maximum of the global COP of its installation. The global COP includes both loop and represents the whole system's performance, it tends to be higher with increased cooling demand.

$$\text{COP}_{\text{prim}} = \frac{Q_{\text{cw}}}{W_{\text{sw}}} \quad (5)$$

$$\text{COP}_{\text{glob}} = \frac{Q_{\text{cw}}}{W_{\text{sw}} + W_{\text{cw}}} \quad (6)$$

Regarding the measurement period, we can consider seasonal variations of the system's performance by calculating the Seasonal COP (SCOP) with (7).

$$\text{SCOP} = \frac{1}{T} \int_0^T \text{COP}_{\text{glob}} \quad (7)$$

The Tetiaroa SWAC installation SCOP is 25.44 for the studied period.

3 NUMERICAL MODEL

3.1 EnergyPlus/Python co-simulation

EnergyPlus is a building energy simulation software used to model energy consumption for Heating Venting and Air-Conditioning (HVAC) and water use in buildings. It will allow us to create a coupled model of the SWAC system and the building in order to include mutual influence between both. EnergyPlus now provides a Python API which enables the integration of user-defined scripts. These scripts called plugins can be triggered at various simulation points, these points are the same as those defined for the EMS (Energy Management System) feature.

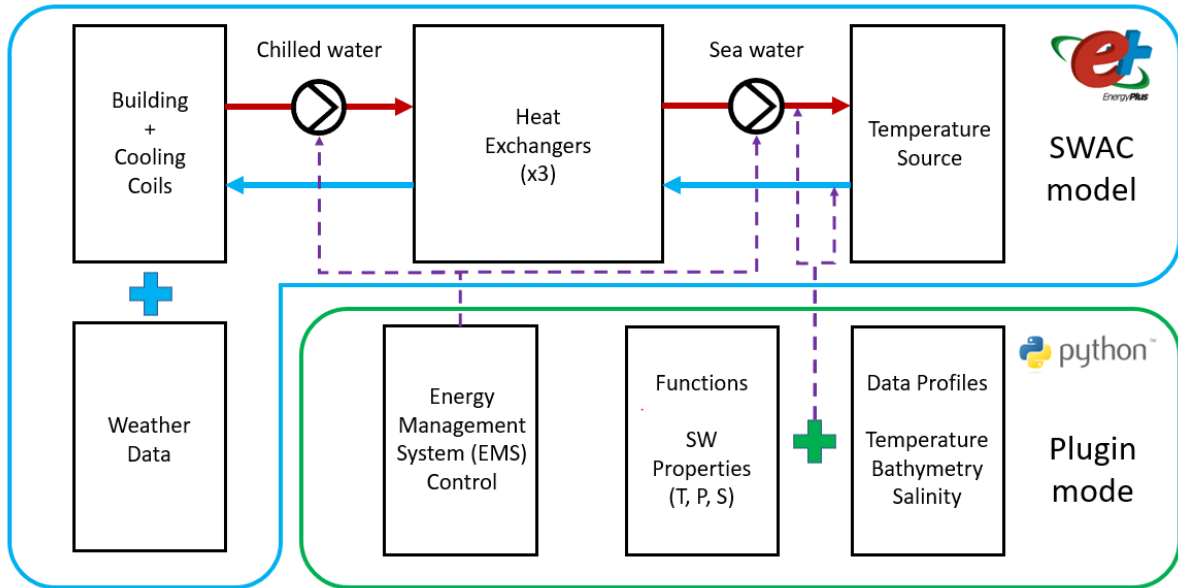

Figure 6: Block diagram of SWAC numerical model

The block diagram of the SWAC numerical model is represented in Figure 6. The blue block depicts the EnergyPlus built-in models used, and the green block represents the additional features from the plugins and their impact on the running simulation with violet arrows.

Python plugins are first used to accurately estimate the pump head of each loop depending on their respective flowrates (8) using the equivalent hydraulic resistance calculation in (9) and (10).

$$\Delta P = \rho g R \dot{V}^2 \quad (8)$$

$$R = \sum_{i=1}^n \left(\frac{\Delta H}{\dot{V}^2} \right)_n \quad (9)$$

$$\Delta H = \frac{\lambda L}{D} * \frac{v^2}{2g} \quad (10)$$

They are also used to model primary pipeline heat loss to adjust the predicted value of seawater temperature inlet and outlet (11). Heat transfers by forced convection inside, natural convection outside, and conduction through the pipeline are included (12).

$$\frac{dT}{dL} = \frac{2\pi L}{\dot{V}_{sw} c_p} U (T_{ext} - T) \quad (11)$$

$$\frac{1}{U} = \frac{1}{h_{int}} + \frac{1}{h_{ext}} + \frac{e}{\lambda} \quad (12)$$

3.2 Experimental Validation

The numerical model will be validated using the measurements of temperature, flow rate and electrical power gathered on Tetiaroa SWAC installation. The sequence of December 2021 was chosen for convenience as it is complete without data gaps. Measurement data and the simulation results are both on an hourly timestep.

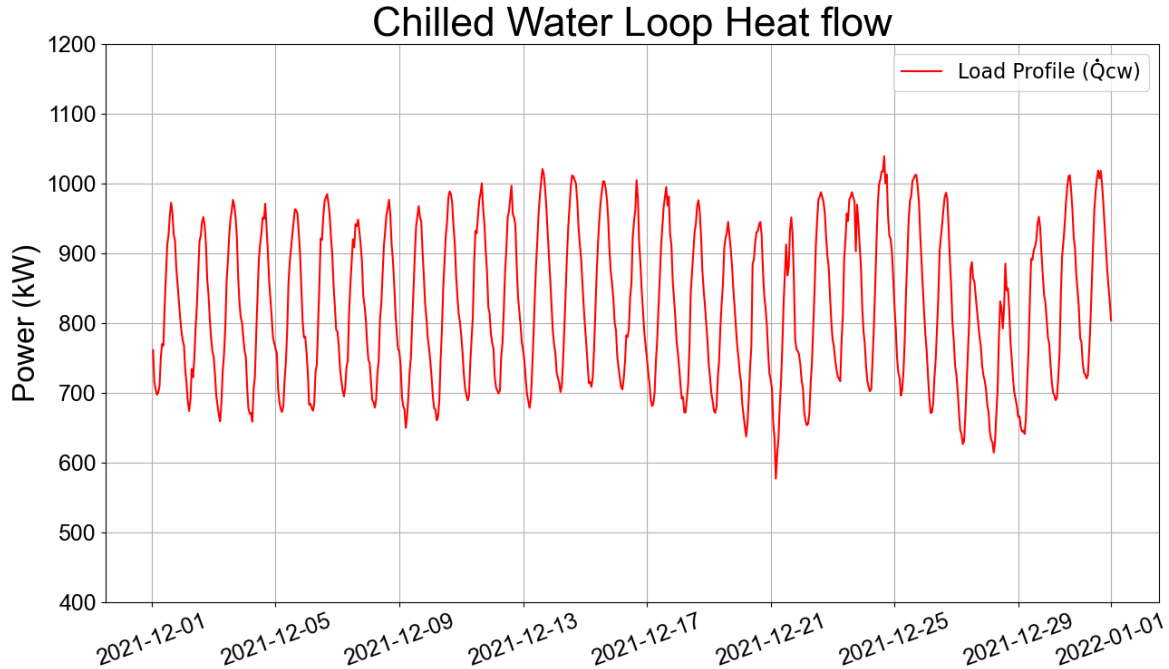

Figure 7: Validation load profile sequence

The chilled water loop heat flow measured in December will be input as a load profile in the model, replacing the building model and weather data. The cooling needs fluctuate between 600 kW and 1 MW, which is less than half of the SWAC nominal power, the installation operates with one pump instead of two. The period of measurements does not include any two-pump operation sequence thus, it is only possible to validate the single pump functioning.

$$r_i = y_i - \hat{y}_i \quad (13)$$

The numerical model results will be plotted with their residuals r_i which are the difference between the measurement y_i and its corresponding predicted value \hat{y}_i (13). The reliability of the model will be assessed by comparing the residuals to the measurement uncertainties, in order to verify that the variability of model predictions remains in an acceptable range and thus, that the model is correctly representing the system's behavior.

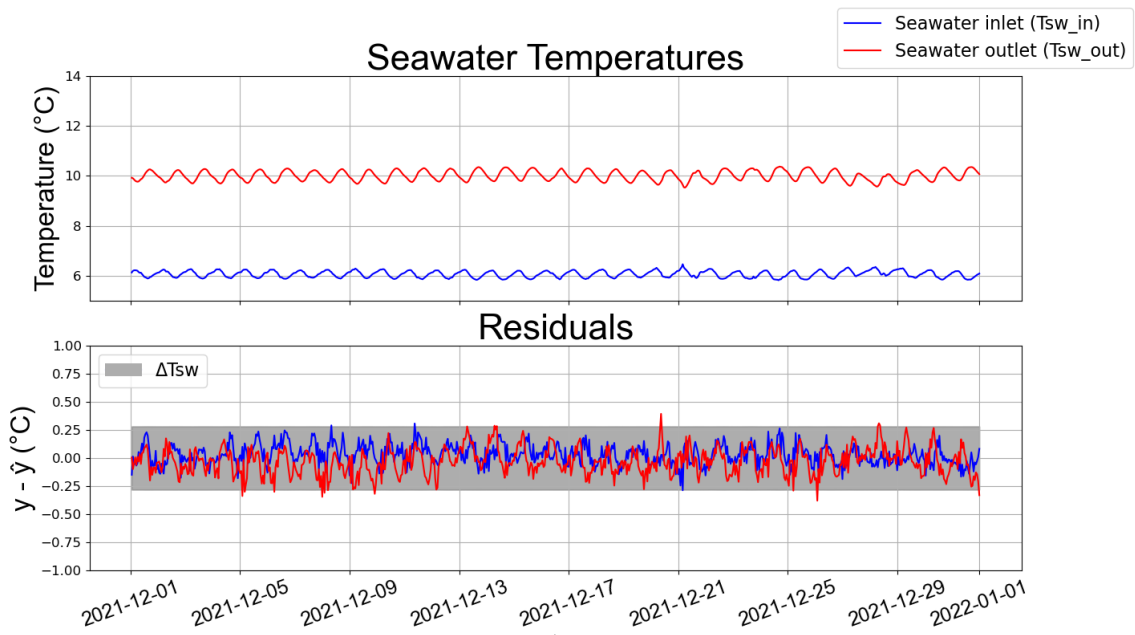

Figure 8: Modeling of seawater temperatures with residuals and measurement uncertainty

Seawater temperatures fluctuate daily around 6°C for the inlet and 10°C for the outlet. Their uncertainties are both represented by the grey band, corresponding to a relative uncertainty of $\pm 0.1\%$ and approximately $\pm 0.28^\circ\text{C}$. The two residuals remain predominantly within the range of the temperature sensor uncertainties.

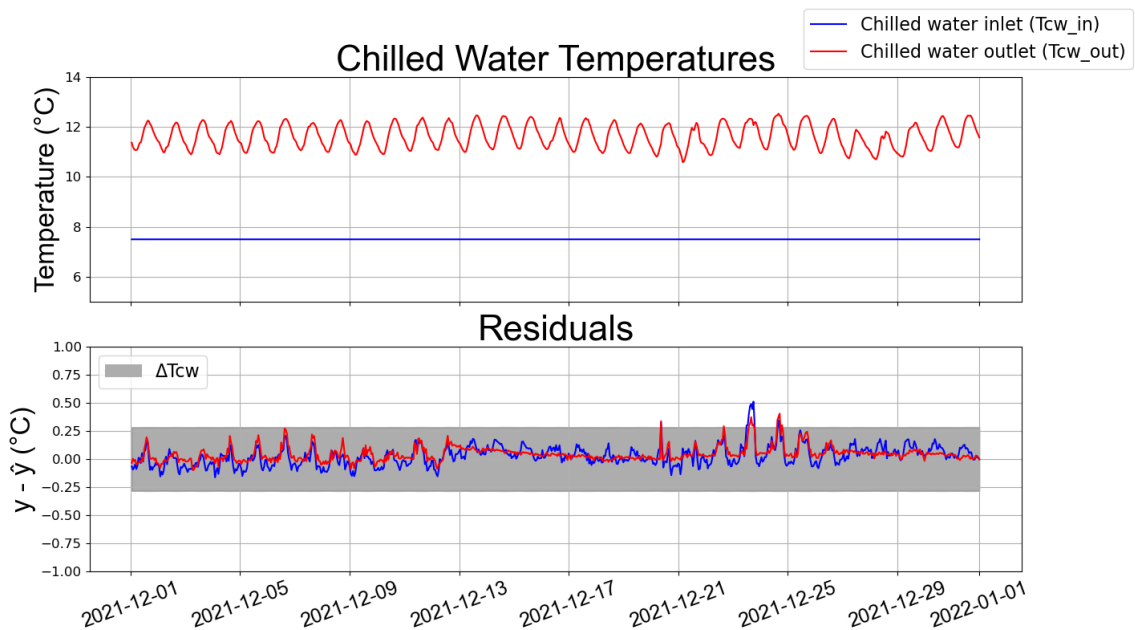

Figure 9: Modeling of chilled water temperatures with residuals and measurement uncertainty

The chilled water inlet temperature is a constant temperature setpoint adjusted to 7.5°C. The outlet temperature is oscillating daily between 11°C and 12.5°C. Residuals for the chilled water loop temperatures also stay within the uncertainty band of $\pm 0.28^\circ\text{C}$, except for December 23rd. This deviation was caused by a manual intervention from the installation operator.

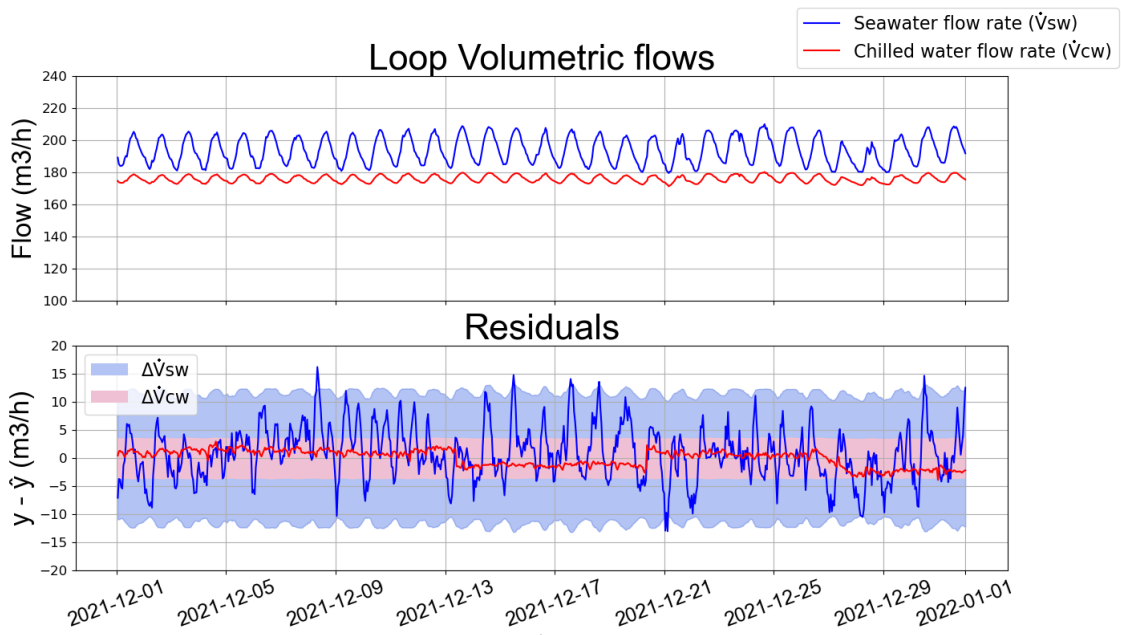

Figure 10: Modeling of loop flows with residuals and measurement uncertainty

The water flow rate of each loop represented above along with its uncertainty band, they follow the same fluctuations as the load profile with an average of 194 m³/h for the primary loop and 176 m³/h for the secondary loop. Their respective relative uncertainties are +/- 6 % (due to a suboptimal flowmeter placement) and +/- 2 %, thus approximately +/- 11.7 m³/h and +/- 3.5 m³/h.

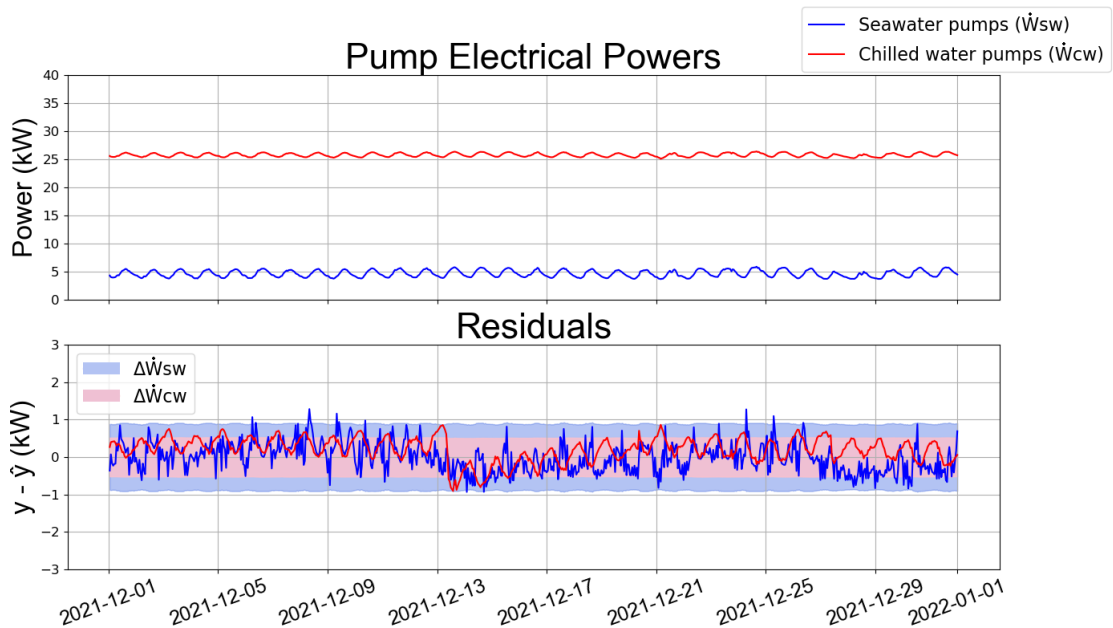

Figure 11: Modeling of pump electrical powers with residuals and measurement uncertainty

The pump electrical power consumptions have a relative uncertainty of +/- 2 %. However, the primary loop of the SWAC installation includes a vacuum pump with a nominal power of 1.6 kW. This pump operation is unknown, therefore introducing an additional random error on the primary power of +/- 0.8 kW. The uncertainty is around +/- 0.9 kW for the seawater pumps and 0.52 kW for the chilled water pumps. Small deviations can also occur because the installation includes, for each loop, 3 pumps in parallel rotating in sequence on a weekly basis, which are considered perfectly identical by the numerical model.

4 CONCLUSIONS

The SWAC provides support to a natural ventilation solution when the latter is no longer applicable or feasible due to external pollution (pollutants, noise, dust...), extreme weather conditions, or excessive internal loads. The data collected over a span of two years in The Brando hotel at the Tetiaroa site, one of the three deep Seawater Air Conditioning (SWAC) installations operating worldwide, provides us with a comprehensive understanding of the technology's performance and its seasonal variations. The primary Coefficient of Performance (COP) exhibits a range between 100 and 200, while the global COP ranges from 15 to 38. Notably, the Tetiaroa SWAC installation demonstrates an impressive Seasonal Coefficient of Performance (SCOP) of 25.44 over the two-year period, which is six times higher than the weighted average SCOP of traditional air conditioning systems, which typically ranges between 4 and 4.5 (International Energy Agency (IEA) 2018). To experimentally validate the numerical model of the SWAC system developed in EnergyPlus/Python, a data sequence of one month was used, analyzing seawater and chilled water temperatures, loop flow rates, and electrical pump consumptions predicted values. The accuracy of the model was confirmed as each residual match with its respective measurement uncertainty. In future work, this validated model, integrated with realistic cost data, will enable the exploration of design and operational variants to optimize performance and mitigate the high initial investment associated with SWAC technology. Allowing the worldwide development and adoption of SWAC in coastal areas that are traditionally deemed less favorable for such cooling systems.

5 ACKNOWLEDGEMENTS

This work was supported by the French Environment and Energy Management Agency (ADEME) and the University of French Polynesia. The authors would like to thank the Pacific Beachcomber group and especially its CEO Richard Bailey, its manager Bruno Chevallereau and Clément Capel for allowing us to exploit data from The Brando SWAC installation. Its instrumentation was funded as a part of the COPSWAC project by the ADEME and the Polynesian government which we thank as well.

6 REFERENCES

- Giraud, Melanie. s. d. « Evaluation de l'impact potentiel d'un upwelling artificiel lié au fonctionnement d'une centrale à énergie thermique des mers sur le phytoplancton ». International Energy Agency (IEA). 2018. « The Future of Cooling », 92.
- Sanjivy, Kanhan, Olivier Marc, Neil Davies, et Franck Lucas. 2023. « Energy Performance Assessment of Sea Water Air Conditioning (SWAC) as a Solution toward Net Zero Carbon Emissions: A Case Study in French Polynesia ». *Energy Reports* 9 (décembre): 437-46. <https://doi.org/10.1016/j.egyr.2022.11.201>.

Nomenclature					
cp	Heat capacity	P	Pressure	W	Electrical pump power
D	Pipeline diameter	Q	Heat flow	λ	Thermal conductivity
e	Pipeline thickness	R	Hydraulic resistance	ρ	Density
g	Gravity of Earth	T	Temperature	cw	Chilled Water
H	Hydrostatic pressure	U	Overall heat transfer coefficient	sw	Sea Water
h	Heat transfer coefficient	V	Volumetric flow rate	in/out	inlet / outlet
L	Pipeline length	v	Flow speed	int/ext	interior / exterior
